

# BOOMS

## TABLE OF CONTENTS

---

### 1 – INTRODUCTION

A Word From Hagie Manufacturing Company .....	1-1
About This Manual .....	1-1
Safety Messages Used In This Manual .....	1-2
Service and Assistance .....	1-2
Identification .....	1-3
Specifications .....	1-4
2014 Product Warranty .....	1-6

### 2 – SAFETY AND PRECAUTIONS

Safety Precautions .....	2-1
Safety Decals .....	2-3

### 3 – OPERATING YOUR SPRAY BOOM

Operator's Station .....	3-1
Spray Booms - 60/80/90/100' .....	3-5
Spray Booms - 120/132' .....	3-13

### 4 – MAINTENANCE AND STORAGE

Service - Lubrication .....	4-1
Service - Miscellaneous .....	4-3
Service Intervals .....	4-6
Storage .....	4-7

### 5 – MISCELLANEOUS

Transporting .....	5-1
Quick-Tach System - Spray Booms .....	5-3
Troubleshooting .....	5-15

# BOOMS

## SECTION 1 – INTRODUCTION

---

The following patent decal is located on the front of the attachment and provides current patents issued on your spray boom.

*NOTE: Hagie Manufacturing Company reserves the right to make changes to any current patents or patents pending at any time, without notice.*



Hagie Manufacturing Patent Decal  
(Located on the front of attachment)

---

### A WORD FROM HAGIE MANUFACTURING COMPANY

Congratulations on the purchase of your spray boom attachment! We recommend that you review this operator's manual and become familiar with operating procedures and safety precautions before attempting to operate your spray boom.

As with any piece of equipment, certain operating procedures, service, and maintenance are required to keep your spray boom in top running condition. We have attempted herein to cover all of the adjustments required to fit varying conditions. However, there may be times when special care must be considered.

*NOTE: The user is responsible for inspecting the spray boom and having parts repaired or replaced when continued use of the product causes damage or excessive wear to other parts.*

Hagie Manufacturing Company reserves the right to make changes in the design and material of any subsequent spray boom without obligation to existing attachments.

Thank you for choosing a Hagie spray boom and we ensure you of our continued interest in its satisfactory operation for you. We are proud to have you as a customer!

---

### ABOUT THIS MANUAL



### NOTICE

The purpose of this manual is to guide you in operating the spray boom attachment. Read this manual in addition to the sprayer operator's manual, and all other literature that is included with the machine.

This manual is only intended to cover the spray boom attachment and any differences in the operation of the sprayer controls. Refer to your sprayer operator's manual for complete instructions on machine operation.

### NOTICE

Any pictures contained within this operator's manual that depict situations with shields, guards, rails, or lids removed are for demonstration only. Hagie Manufacturing Company strongly urges the operator to keep all shields and safety devices in place at all times.

This manual will aid you in the proper operation and service of your spray boom attachment. It is the responsibility of the user to read the operator's manual and comply with the correct and safe operating procedures, as well as maintain the product according to the service information provided in the *Maintenance and Storage* section elsewhere in this manual.

Photographs and illustrations used in this manual are of general nature only. Some of the equipment described and/or shown may or may not be available on your spray boom.

Information described in this manual was correct at the time of printing. Because of Hagie Manufacturing Company's continuous product improvement, certain information may not be included in this manual. To obtain the most current operator's manual for your attachment, please visit [www.hagiehelp.com](http://www.hagiehelp.com).

Keep this manual in a convenient place for easy reference, should problems arise. This manual is considered a permanent fixture of the product. In the event of resale, this manual should accompany the spray boom.

If you do not understand any part of this manual or require additional information or service, contact Hagie Customer Support for assistance.

---



---

## SAFETY MESSAGES USED IN THIS MANUAL

The following safety messages found throughout this manual alert you of situations that could be potentially dangerous to the operator, service personnel, or equipment.

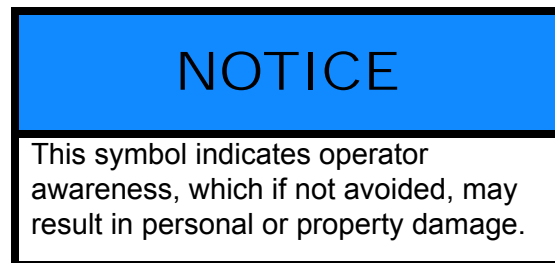
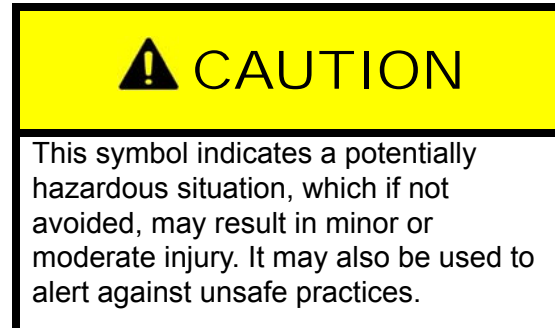
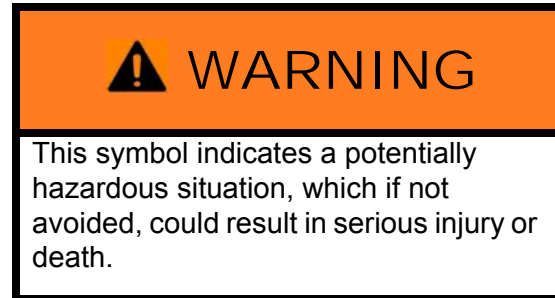
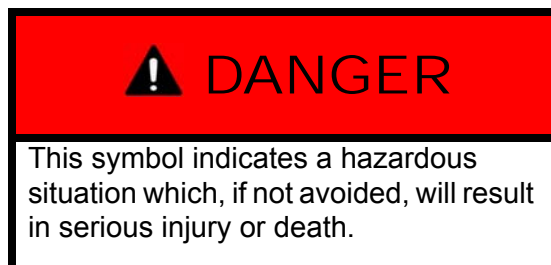

*NOTE: A "Note" is intended to make special mention of, or remark on.*

---



---

## SERVICE AND ASSISTANCE

For service and assistance, please contact:

**Hagie Manufacturing Company**  
**721 Central Avenue West**  
**P.O. Box 273**  
**Clarion, IA 50525-0273**  
**(515) 532-2861 OR (800) 247-4885**  
**[www.hagiehelp.com](http://www.hagiehelp.com)**

---

---

IDENTIFICATION

**NOTICE**

Reference to the right and left-hand used throughout this manual refers to the position when seated in the operator's seat facing forward.

The spray boom is identified by a serial number stamped on the transom. This serial number denotes the model, year in which it was built, and the number of the attachment.

To ensure prompt, efficient service when ordering parts or requesting service repairs, record the serial number in the following space provided.

\_\_\_\_\_ **Spray Boom**

**Steel Spray Booms (90/100')**

The steel spray boom serial number is stamped on the bottom right-hand side of transom.

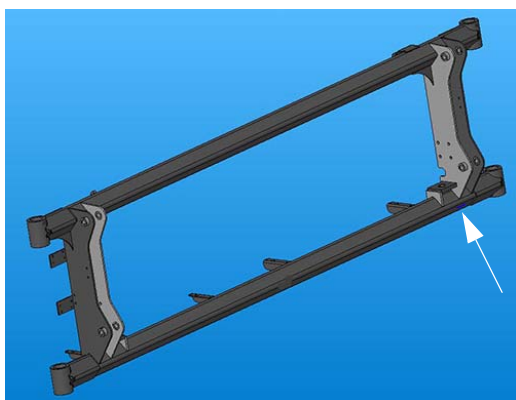

Steel Spray Boom Serial Number  
-Typical View

**Aluminum Spray Booms  
(120/132')**

The aluminum spray boom serial number is stamped on the lower right-hand side of fixed transom.

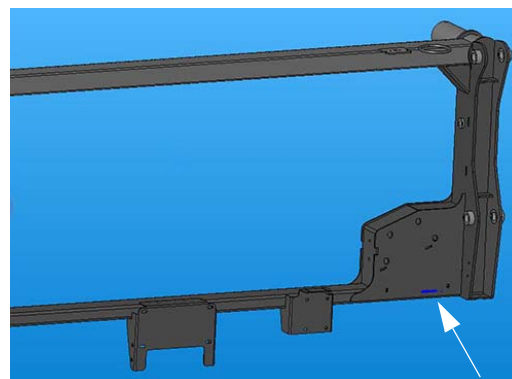

Aluminum Spray Boom Serial Number  
-Typical View

**SPECIFICATIONS**

*NOTE: Refer to “Specifications” provided in the machine operator’s manual for complete machine and boom dimensions.*

**60/80/90-ft. Spray Boom**

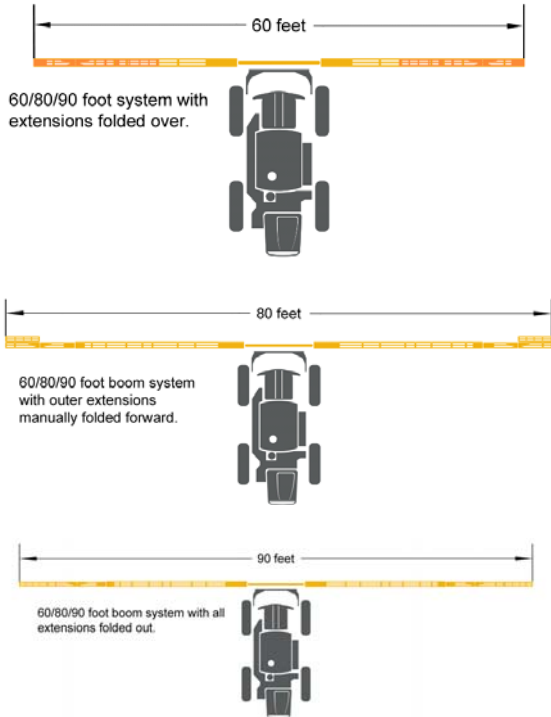

**120/132-ft. Spray Boom**

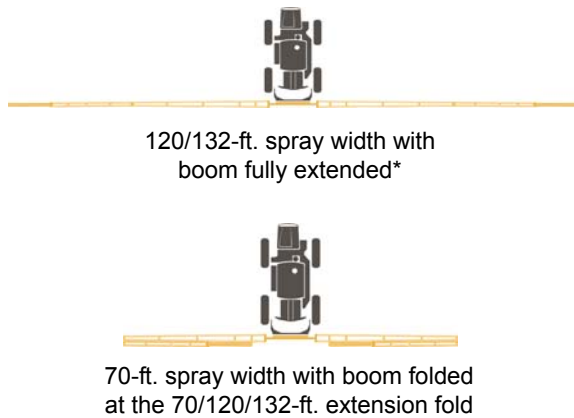

\* Recommended spray width

**120/132-ft. Breakaway Locations**

- (A) - Main Pivot Breakaway
- (B) - Outer Breakaway Tip

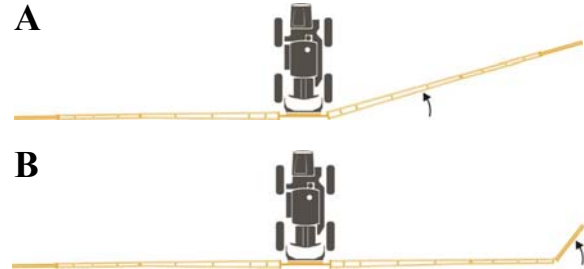

**Approximate Dry Weight**

- 4,500 lbs./2,041 kg (90’ boom)
- 5,000 lbs./2,268 kg (100’ boom)
- 5,900 lbs./2,676 kg (120’ boom)
- 6,600 lbs./2,993 kg (132’ boom)

Item	Specification
<b>General</b>	
Spray Booms	60/80/90/100-ft. (9 sections), 120/132-ft. (optional)
Type	Dry with variable row spacing (wet optional)
Controls	Electro-hydraulic (fold/lift/level)
Level Shock Absorber	Gas charged accumulator
80/90/100-ft. Outer Boom Hydraulic Breakaway	Self-actuated, auto-reset hydraulic
120/132-ft. Inner Boom Breakaway	Hydraulic, manual reset
120/132-ft. Outer Boom Breakaway	Mechanical with spring, auto reset
Pressure Gauge	100 PSI (6.9 bar), glycerin filled
Fence Row Nozzle	2-position, remove activated
Solution Valves	Electric ball valves
<b>Electrical (Lights)</b>	
Transom	2 trapezoidal headlights (if equipped)
Transom Mount	2 trapezoidal headlights (high/low beam), 2 oval amber lights (combined)
Boom Cradle	2 trapezoidal floodlights (1 on each cradle), 2 oval amber lights (1 on each cradle)
Spray Section Indicators (located on boom, if equipped)	1 oval white, 2 oval amber, 9 oval red (10, if equipped with 90-ft. and 120/132-ft. booms)

---

---

## 2014 PRODUCT WARRANTY

### **Hagie Manufacturing Company Product Warranty**

Hagie Manufacturing Company warrants each new Hagie product to be free under normal use and service from defects in workmanship and materials for a period of lesser of: two (2) years or 1000 hours from the date of delivery on all Agricultural Products. Hagie Manufacturing Company makes this warranty from the original delivery date and is transferable to a purchaser from the original purchaser of this equipment, given there is remaining time left under the year and hour warranty standard stated above. This warranty shall be fulfilled by repairing or replacing free of charge any part that shows evidence of defect or improper workmanship, provided the part is returned to Hagie Manufacturing Company within thirty (30) days of the date that such defect or improper workmanship is discovered, or should have been discovered. Labor to repair said items will be covered by standard labor time rates. Freight charges of defective parts are not covered by this warranty and are the responsibility of the purchaser. No other express warranty is given and no affirmation of Hagie Manufacturing Company, by words or action, shall constitute a warranty.

Hagie Manufacturing Company limits its warranty to only those products manufactured by Hagie Manufacturing Company and does not warrant any part or component not manufactured by Hagie Manufacturing Company, such as parts or components being subject to their manufacturer's warranties, if any. Excluded from this warranty are parts subjected to accident, alteration, or negligent use or repair. This warranty does not cover normal maintenance such as engine tune ups, adjustments, inspections, nor any consumables such as tires, rubber products, solution system valves, wear parts, wiper blades, etc.

Hagie Manufacturing Company shall not be responsible for repairs or replacements which are necessitated, in whole or in part; by the use of parts not manufactured by or obtainable from Hagie Manufacturing Company nor for service performed by someone other than Hagie authorized personnel, unless authorized by Hagie Manufacturing Company. Customer acknowledges that it is not relying on Hagie Manufacturing Company's skill or judgment to select finish goods for any purpose and that there are no warranties which are not contained in this agreement.

In no event shall Hagie Manufacturing Company's tort, contract, or warranty liability exceed the purchase price of the product. The foregoing limitation will not apply to claims for personal injury caused solely by Hagie Manufacturing Company's negligence.

Hagie Manufacturing Company shall not be liable for damages, including special, incidental or consequential damages or injuries (damage and repairs of equipment itself, loss of profits, rental or substitute equipment, loss of good will, etc.) arising out of or in connection with performance of the equipment or its use by customer, and Hagie Manufacturing Company shall not be liable for any special, incidental or consequential damages arising out of or in connection with Hagie Manufacturing Company's failure to perform its obligation hereunder. HAGIE MANUFACTURING COMPANY'S ENTIRE LIABILITY AND THE CUSTOMER'S EXCLUSIVE REMEDY SHALL BE REPAIR OR REPLACEMENT OF PARTS COVERED UNDER THIS WARRANTY. THIS WARRANTY IN LIEU OF ALL OTHER WARRANTIES, EXPRESSED OR IMPLIED, INCLUDING, BUT NOT LIMITED TO THE IMPLIED WARRANTY OF MERCHANTABILITY OR FITNESS FOR A PARTICULAR PURPOSE.



Most accidents occur as the result of failure to follow basic and fundamental safety rules and precautions. Recognizing potential safety hazards, following correct and safe operating procedures described in this manual, and complying with safety warnings located throughout the machine and attachment may reduce the risk of accidents.

There is no way to completely eliminate the potential for danger when operating agricultural equipment. Therefore, you must study this operator's manual and understand how to operate the attachment controls for safe operation before using the attachment. Likewise, never let anyone operate the attachment without proper instruction.

Do not operate the attachment for anything other than its intended use. Hagie Manufacturing Company shall not be liable for any damage, injury, or death associated with improper use of the attachment.

Do not make any modifications such as weldments, add-ons, adaptations, or changes from the original design of the attachment. Such modifications may become safety hazards to you and others and **will void all warranties**.

Replace missing, faded, or damaged safety signs. Refer to "Safety Decals" elsewhere in this section for correct sign and placement.

---

---

### SAFETY PRECAUTIONS

#### General Safety

- The hydraulic and electrical control systems are optimized for use with this attachment. Any modification to these systems may lead to unintended or uncontrolled motion. Do NOT install add-on control systems that are not approved by Hagie Manufacturing Company.
- Some conditions cannot be completely safeguarded against without interfering with efficient operation of the machine and/or

reasonable accessibility. In these cases, decals have been installed to provide the operator with hazard information.

Do NOT remove decals for any reason. If a decal is damaged or missing, contact the Hagie Customer Support Department for replacement.



#### Wear Protective Clothing

- Do not wear loose fitting clothing that could get caught in moving parts. Wear safety equipment that is appropriate for the job.



- Do not store chemical-soaked clothes in the cab. Clean off as much mud and dirt from your shoes as you can before entering the cab.

#### Be Prepared

- Be prepared for an emergency. Keep a fire extinguisher handy. Keep a first aid kit and clean water in the cab.
- Make sure to service the fire extinguisher regularly. Keep an accurate inventory of supplies in the first aid kit and dispose of anything that has expired.





### General Repair/Maintenance Safety

- Turn off sprayer engine before checking, adjusting, repairing, lubricating, or cleaning any part of the attachment.
- Disconnect the battery ground cable and turn the Battery Disconnect Switch OFF before servicing the electrical system or welding on an attachment.



### Safe Hydraulic Maintenance

- Always practice personal safety when performing service or maintenance on the hydraulic system.

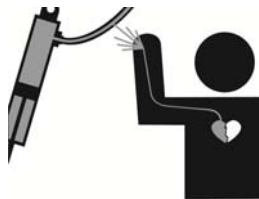

- Use caution when working around hydraulic fluid under pressure. Escaping fluid can have sufficient force to penetrate your skin, causing serious injury. This fluid may also be hot enough to burn.
- Always lower the load or relieve pressure before repairing a hydraulic leak.
- Avoid torching, welding, and soldering near pressurized hydraulic lines. Pressurized lines may accidentally burst when

heat goes beyond the immediate flame area.



### General Spray Boom Safety

- Select a safe area before unfolding/folding the booms.
- Clear area of personnel.
- Cradle booms when leaving sprayer unattended.
- Ensure booms are folded when cradled.
- Do not unfold/fold boom extensions when main boom is in the cradle.
- Do not operate sprayer with one boom out of cradle and other boom in cradle.
- Check for overhead obstructions.
- Do not fold or unfold booms near power lines.

**Contact with power lines can result in serious injury or death.**



- A warning message will appear on the Machine Display before extending the outer boom extensions or when operating in Auto Fold. Press ACKNOWLEDGE showing that you have acknowledged that there are no overhead power lines or obstructions before proceeding.

### Cold Oil Scenarios

- If the oil temperature is less than 50°F, the operator may experience control loss on the 90-ft. and 100-ft. fold cylinders. These cylinders are the main cylinders affected by over-running loads due to the weight rotation of the boom during unfold/fold situations. When the oil is cold, the valve response

is not as fast or accurate. Therefore, when having to lift the weight, the cylinder will move slower, but in trying to suspend the weight, the weight may cause faster movement, as the valve is not dampening the flow like it normally would.

*NOTE: This situation requires the operator to clear area of personnel.*

## Handle Agricultural Chemicals Safely

Agricultural chemicals used in applications can be harmful to your health and the environment if not used carefully.

- Always follow the manufacturer's label for directions of use.
- Never allow chemicals to come in contact with your skin or eyes. Always use the proper Personal Protective Equipment (PPE).
- NEVER pour chemicals into an empty tank. Always fill tank half full of water first.
- Dispose of empty chemical containers properly.



- Wash spilled chemicals or spray residue from the sprayer to prevent corrosion and deterioration.
- Select safe areas to fill, flush, calibrate, and clean sprayer where chemicals will not run off to contaminate people, animals, vegetation, or water supply.
- Never place a spray nozzle to your lips in an attempt to unclog it.
- Do not spray when wind is in excess of chemical manufacturer's recommendation.

- Store chemicals in their original containers with the label intact.
- Store chemicals in a separate, locked building.
- Wear Personal Protective Equipment (PPE) as recommended by the chemical manufacturer.

---

---

## SAFETY DECALS

Decals warning you of avoidable danger are located on various parts of the attachment. They are there for your personal safety and protection. DO NOT remove them. They will fracture upon attempted removal and therefore, must be replaced.

Following are locations of important safety decals. Replace them if they are damaged or missing. All safety decals, instructional decals, or machine striping may be purchased through the Hagie Customer Support Department.

To replace safety decals, ensure the installation area is clean and dry and decide on exact position before you remove the backing paper.

### Decal Locations

**650178**  
**(2) Quick-Tach**

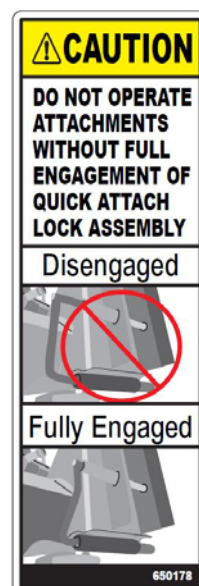

**650201**  
(2) - One located at each folding section along boom



**650210**  
(3) - One located on each Norac® sensor



**650203**  
(Located on transom)



**650339**  
(Located on left-hand front cross member)



**650204**  
(2) - One located at each folding section along the boom



**650208**  
(Located on transom)

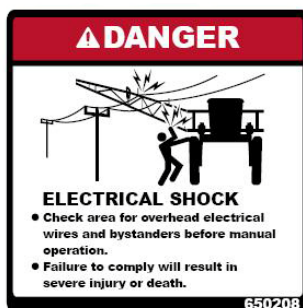

# BOOMS

## SECTION 3 – OPERATING YOUR SPRAY BOOM

### OPERATOR'S STATION

*NOTE: Refer to the sprayer operator's manual for a full description of cab functions and spray system operation.*

#### Side Console

- (A) - Boom Solution Valve Switches
- (B) - Fence Row Switch (Left)
- (C) - Fence Row Switch (Right)
- (D) - Boom Extension Switches
- (E) - Right Boom Switch
- (F) - Left Boom Switch
- (G) - Transom Switches (Up/Down)

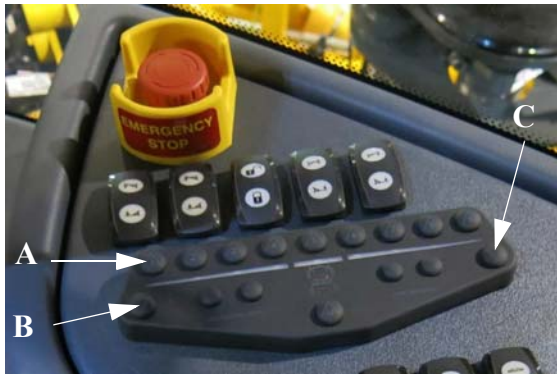

-Typical View



-Typical View

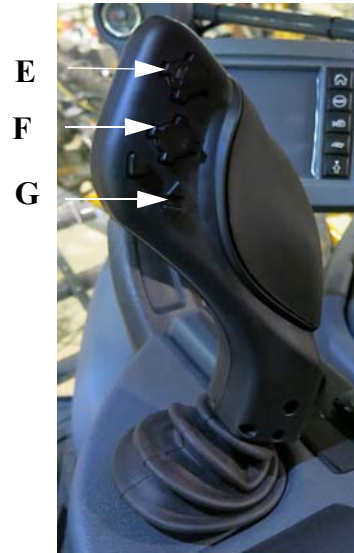

-Typical View

#### Boom Solution Valve Switches

The Boom Solution Valve Switches (located on the side console) each control a valve located on the boom or transom. The valves control the flow of the solution through the boom.



Boom Solution Valve Switches  
(Located on the side console)  
-Typical View

The boom is divided into sections, with the far left tip being the beginning of the first section. Each Boom Solution Valve Switch is equipped with an indicator light and will illuminate red when manually turned off.



**Boom Solution Valve Indicators  
(Transom)****-If Equipped**

Your boom may be equipped with transom-mounted Boom Solution Valve Indicators (located on the center of the transom) to view the current status of the spray sections, master spray, and fence row indicators.

- (2) - Fence Row Indicators (illuminate when ON).
- (1) - Master Spray Indicator (illuminates when ON).
- (9) - Spray Section Indicators (illuminate when OFF).

**Fence Row Switches**

The Fence Row Switches (located on the side console) are used in the selection of either the right or left fence row spray nozzle.

*NOTE: The corresponding Fence Row Switch will illuminate when active.*



Fence Row Switches  
(Located on the side console)  
-Typical View

*NOTE: When either Fence Row Switch is activated, you may notice a drop in solution pressure.*

**Boom Extension Switches  
(Outer Fold)****! WARNING**

When operating or positioning the booms, observe the following safety precautions to avoid serious injury or death:

- Select a safe area before unfolding/folding booms.
- Clear area of personnel.
- Check for overhead obstructions.
- Do not unfold/fold booms near power lines. Contact with power lines can result in serious injury or death.

**! CAUTION**

When operating or positioning the booms, observe the following safety precautions to avoid injury or equipment damage.

- Do not unfold/fold boom extensions when main boom is in cradle.
- Do not operate sprayer with one boom out of cradle and the other boom in cradle.
- Do not transport machine without booms folded and in cradle.

The Boom Extension Switches (located on the side console) are used to extend or retract the outer boom extensions.

*NOTE: On 90-ft. Spray Booms, operate Boom Extension Switch 1 to unfold/fold the outer boom extensions simultaneously. On 120 and 132-ft. Spray Booms, operate both Boom*

*Extension Switches 1 (left) and 2 (right) to unfold/fold the outer boom extensions separately.*

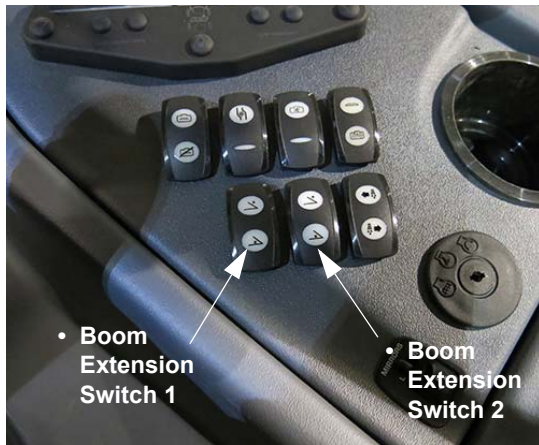

Boom Extension Switches  
(Located on the side console)  
-Typical View

**Left/Right Boom Switches  
(Level/Horizontal Extension)**

The Left and Right Boom Switches (located on the Hydrostatic Drive Control Handle) are used to raise, lower, extend, and retract the booms.



Left and Right Boom Switches  
(Located on the Hydrostatic Drive Control Handle)  
-Typical View

**Transom Switches**

The Transom Switches (located on the Hydrostatic Drive Control Handle) are used to raise and lower the entire lift.



Transom Switches  
(Located on the Hydrostatic Drive Control Handle)  
-Typical View

**Overhead Monitors and Controls**

- (A) - Norac® Monitor
- (B) - Section Indicator Display
- (C) - Machine Display



-Typical View

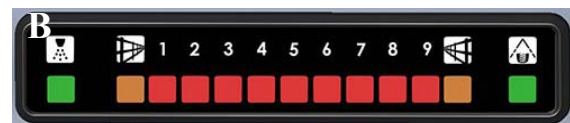

-Typical View



-Typical View

**Norac Monitor**

**-If Equipped**

The Norac Monitor controls the automatic boom leveling system.



Norac Monitor  
-Typical View

Refer to the manufacturer’s operation manual for complete operating instructions and programming information.

**Section Indicator Display**

The Section Indicator Display (located on the cab headliner) allows you to view system status for the following:

- (1) - Master Spray Indicator (illuminates when ON).
- (2) - Fence Row Indicators (illuminate when ON).
- (9) - Spray Section Indicators (illuminate when OFF).
- (1) - Rear Wheel Nozzle Indicator (illuminates when ON).

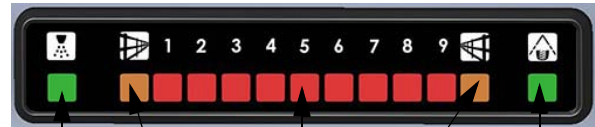

- Master Spray
- Left Fence Row
- Spray Section
- Right Fence Row
- Rear Wheel Nozzle

Section Indicator Display  
(Located on the cab headliner)  
-Typical View

**Machine Display**

The Machine Display is the central control center of the machine. It controls many of the machine’s electronically-driven functions, including attachment operation.



Machine Display  
-Typical View

The Machine Display also activates the Work Lights and Attachment Lights (located on the boom).

**Work Lights**

The Work Lights are located on each of the boom cradles.

- Press the Work Lights Button (WRK) (located on the Machine Display Auxiliary Controls Page) to turn Work Lights ON. Press button again to turn Work Lights OFF.



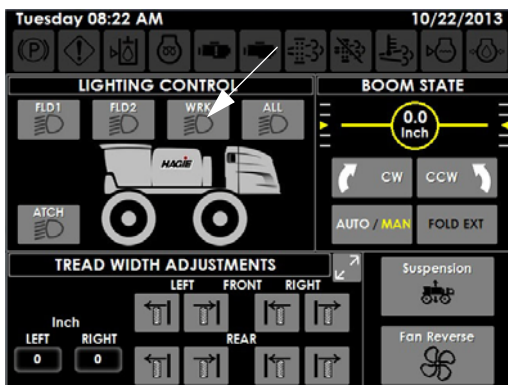

Work Lights Button  
(Located on the Machine Display  
Auxiliary Controls Page)

*NOTE: Turn Work Lights OFF before entering a public roadway.*

*NOTE: The ignition key must be in the ON position to operate the Work Lights.*

### Attachment Lights

#### -If Equipped

The Attachment Lights are located on each side of the attachment.

- Press the Attachment Lights Button (ATCH) (located on the Machine Display Auxiliary Controls Page) to turn Attachment Lights ON. Press button again to turn Attachment Lights OFF.

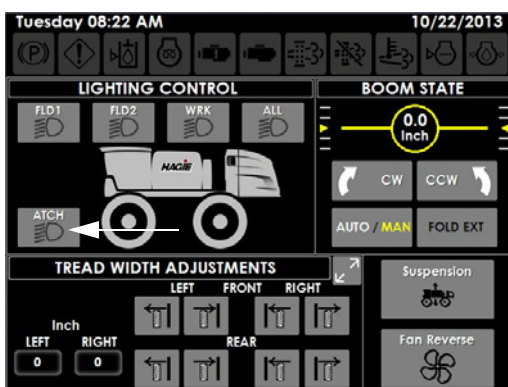

Attachment Lights Button  
(Located on the Machine Display  
Auxiliary Controls Page)

*NOTE: Turn Attachment Lights OFF before entering a public roadway.*

*NOTE: The ignition key must be in the ON position to operate the Attachment Lights.*

## SPRAY BOOMS - 60/80/90/100'

### -If Equipped

The Spray Booms are controlled by an electro-hydraulic system. This system consists of operator-manipulated switches (located on the side console and the hydrostatic drive control handle) and hydraulic cylinders (attached to the booms), which provide lift, level, horizontal extension, and vertical extension.

**⚠ CAUTION**

When operating or positioning the booms, observe the following safety precautions. Failure to comply may result in injury or equipment damage.

- Do not unfold/fold boom extensions when main boom is in cradle.
- Do not operate machine with one boom out of cradle and the other boom in cradle.
- Ensure booms are folded and in cradle before transporting the machine.

**⚠ WARNING**

When operating or positioning the booms, observe the following safety precautions:

- Monitor both sides of the boom during fold procedure.
- Cradle booms when leaving the machine unattended.
- Ensure booms are folded when cradled.
- Select a safe area before unfolding/folding the booms.
- Clear area of personnel.
- Check for overhead obstructions.
- Do not unfold/fold booms near power lines. Contact with power lines can result in serious injury or death.
- Spray equipment is designed for FIELD USE ONLY. Do not attempt to use machinery for anything other than it's intended purpose.

**⚠ WARNING**

Hydraulic and electrical control systems are optimized for use of the spray boom attachment. Any modification to these systems may lead to unintended and uncontrolled motion. **DO NOT** install add-on control systems that are not approved by Hagie Manufacturing Company.

**Power Lines**

Hagie Manufacturing Company cannot stress enough that extreme caution must be taken when operating equipment around power lines. Ensure there is more than sufficient clearance when transporting, unfolding and folding the boom, or spraying near power lines.



As a safety precaution, a Power Line Warning Message will appear on the Machine Display before extending the outer boom extensions. Press ACKNOWLEDGE showing that you have acknowledged that there are no overhead power lines or obstructions before proceeding.

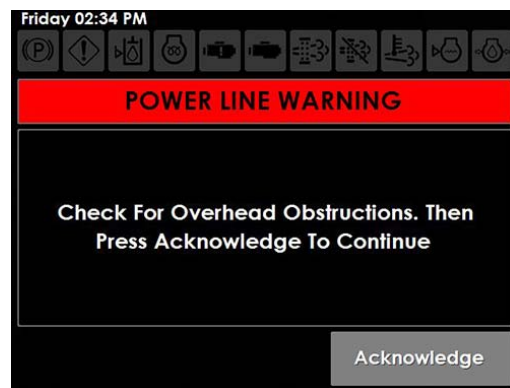

Power Line Warning Message  
(Located on the Machine Display)

Hydraulically folding the extensions of a 60/80/90-ft. or 60/100-ft. Spray Boom, adjusting the spray valves, and recalibrating the spray system console essentially turns it into a 60-ft. Spray Boom.

Manually folding the outer extensions of the 60/80/90-ft. Spray Boom, adjusting the spray valves, and recalibrating the spray system console turns it into an 80-ft. Spray Boom (see the following illustrations).



60/80/90' System with  
Extensions Folded Over



60/80/90' System with Outer  
Extensions Manually Folded Forward

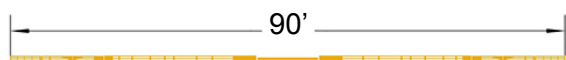

60/80/90' System with all  
Extensions Folded Out



### Hydraulic Breakaway Circuit (90 and 100-ft. Spray Booms)

90 and 100-ft. spray booms are equipped with a Hydraulic Breakaway Circuit. When folded out as an 80, 90, or 100-ft. spray boom, a one-way hydraulic circuit (located on the outer boom section) provides outer boom breakaway functions.

### Spray Boom Components

- (A) - Lift Cylinder
- (B) - Transom
- (C) - Main Pivot Cylinder
- (D) - Level Cylinder
- (E) - Lift Arm
- (F) - Main Boom Section
- (G) - Boom Extension Cylinder
- (H) - Boom Extension
- (I) - Boom Breakaway Cylinder



Outer Boom Breakaway  
-Typical View

When the outer boom section breaks away, it will return to the “spray” position (after it has cleared the hazard), but will not be in the locked position.

### To Reset the Outer Boom Breakaway:

- Press and hold the Reset Breakaways Button (Located on the Machine Display Auxiliary Controls Page) until the outer boom sections are in the LOCKED position.

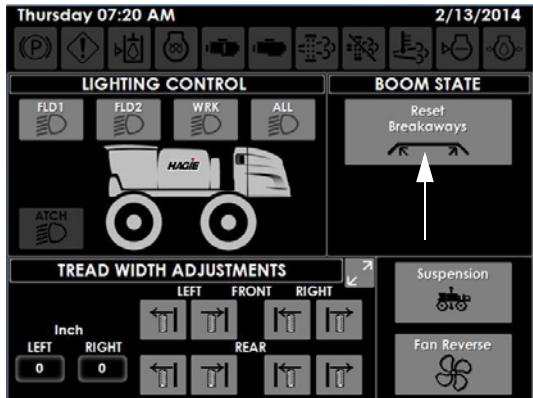

Reset Breakaways Button  
(Located on the Machine Display  
Auxiliary Controls Page)



Left and Right Boom Switches  
(Located on the Hydrostatic  
Drive Control Handle)  
-Typical View

### Spray Boom Extension (Unfold)

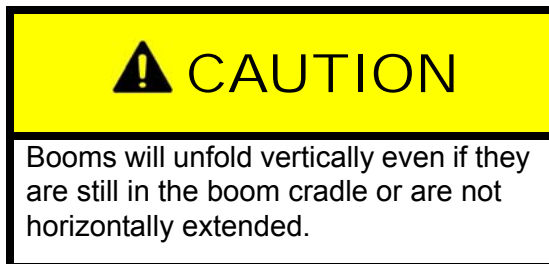

*NOTE: Ensure the Hydrostatic Drive Control Handle is in the NEUTRAL position. If the machine is put in gear during fold operation, boom movement will stop.*

*NOTE: DO NOT lower the main lift while the boom is in the cradle.*

1. Press and hold the Left and Right Boom Switches (located on the Hydrostatic Drive Control Handle) in the UP position to raise the level cylinders all the way up.



Left and Right Boom Switch Orientation  
-Typical View

2. Press and hold the Left and Right Boom Switches in the OUT position to unfold the main boom sections until they come to a complete stop.
3. Lower the level cylinders until the boom is parallel with the ground.

### 90-ft. Spray Booms

- Press and hold the Boom Extension Switch (located on the side console) in



the UP position to unfold the left and right boom extensions all the way OUT.

*NOTE: Both left and right boom extensions move simultaneously when the Boom Extension Switch is pressed.*



Boom Extension Switch  
\*90-ft. Spray Booms  
(Located on the side console)  
-Typical View



Boom Extension Switch  
\*90-ft. Spray Booms  
(Located on the side console)  
-Typical View

2. Press and hold the corresponding Left and Right Boom Switches (located on the Hydrostatic Drive Control Handle) in the UP position to raise the level cylinders all the way up.

### Spray Boom Retraction (Fold)

*NOTE: Ensure the Hydrostatic Drive Control Handle is in the NEUTRAL position. If the machine is put in gear during fold operation, boom movement will stop.*

1. Lower the level cylinders until the boom is parallel with the ground.

#### 90-ft. Spray Booms

- Press and hold the Boom Extension Switch (located on the side console) in the DOWN position to fold the left and right boom extensions all the way IN.

*NOTE: Both left and right boom extensions move simultaneously when the Boom Extension Switch is pressed.*



Left and Right Boom Switches  
(Located on the Hydrostatic Drive Control Handle)  
-Typical View



Left and Right Boom Switch Orientation  
-Typical View

3. Press and hold the corresponding Left and Right Boom Switches (located on the Hydrostatic Drive Control Handle) in the IN position until the main boom sections are aligned with boom cradles.
4. Lower the level cylinders until the boom sections are seated in the boom cradles.



**Manual Fold**

**(90-ft. Spray Boom to an 80-ft. Spray Boom)**

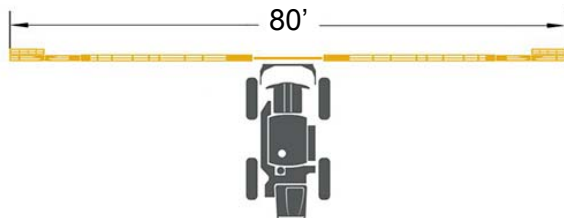

60/80/90' System with Outer Extensions Manually Folded Forward

1. Close the Solution Valve (located on the outer boom section) (A).
2. Remove the bolt (located on the back side of the boom) (B), so it will hinge forward (C), and secure it with the rear bolt (D).

3. Repeat Steps 1 and 2 on the opposite side and recalibrate the spray system console accordingly before resuming spray application.

Refer to the spray system console manufacturer's operation manual for recalibrating information.

**Enabling/Disabling Norac® in the Pulse Display**

**-If Equipped**

*NOTE: Hagie Manufacturing Company recommends turning the Norac Monitor OFF when traveling from*

*one field to the next. A power switch is located on the back side of the monitor.*



Norac Monitor  
-Typical View

- **To Enable**, press the corresponding Auto or Manual Button (located on the main “Run Screen”) to the ON (green illuminated position).

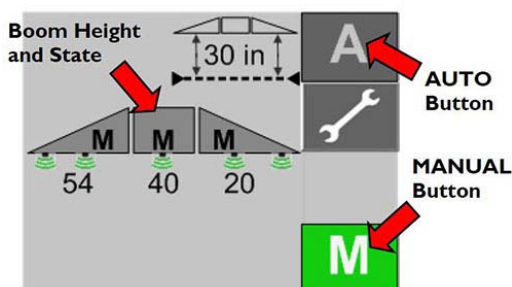

Auto/Manual Buttons - Norac  
(Located on the main “Run Screen”)  
-Typical View

*\* Your monitor may vary in appearance, depending on model*

- **To Disable**, press the corresponding Auto or Manual Button to the OFF (gray) position or press any one of the following boom control switches (located on the Hydrostatic Drive Control Handle):
  - Transom Switch (Up/Down)
  - Left or Right Boom Switch (Up/Down)

*NOTE: If the Norac System becomes inoperable, the Auto and Manual Fold functions will still operate.*

## Enabling/Disabling Norac in the Ag Leader® Display

-If Equipped

- **To Enable**, press the Auto/Manual Button (located on the main “Run Screen”) to the ON (green illuminated position).

*NOTE: When the system is engaged, the boom image will change from black to blue.*

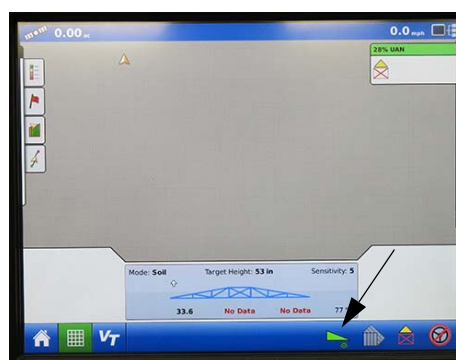

Auto/Manual Button - Ag Leader  
(Located on the main “Run Screen”)  
-Typical View

*\* Your monitor may vary in appearance, depending on model*

- **To Disable**, press the Auto/Manual Button to the OFF (white) position or press any one of the following boom control switches (located on the Hydrostatic Drive Control Handle):
  - Transom Switch (Up/Down)
  - Left or Right Boom Switch (Up/Down)

*NOTE: When the system is disabled, the boom image will change from blue to black.*

*NOTE: If the Norac System becomes inoperable, the Auto and Manual Fold functions will still operate.*



## Norac/Ag Leader System Settings

### -If Equipped (Soil/Crop Mode, Target Height, and Sensitivity)

*NOTE: Settings may be adjusted through the main Run Screen by pressing the Boom Image or the Settings Button (wrench icon), depending on model. Refer to the Norac or Ag Leader manufacturer's operation manual for further information.*

### Soil/Crop Mode

Soil Mode allows the sensors to read the height from the spray nozzles to the ground. Crop Mode allows the sensors to read the height from the spray nozzles to the top of the crop canopy.

### On the Norac Pulse Monitor:

- Press the Settings Button (wrench icon) (located on the main “Run Screen”) to navigate to the Settings Screen.
- Press the Next Button (located next to “Mode”) and select Soil, Crop, or Hybrid Mode.

*NOTE: Hybrid Mode is an improved Crop Mode, which uses a combination of the crop and oil readings to improve control. This setting is recommended in place of Crop Mode.*

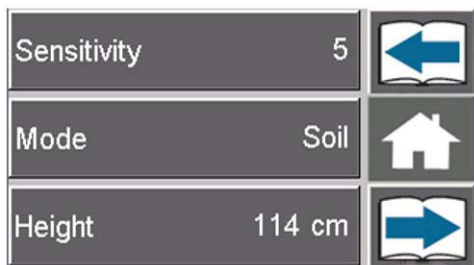

Settings Screen  
(Norac)  
-Typical View

*\* Your monitor may vary in appearance, depending on model*

### On the Ag Leader Monitor:

- Press the Boom Image (located on the main “Run Screen”).
- Press the top drop-down arrow (located on the Boom Height Control Options Screen) and select Soil or Crop Mode.

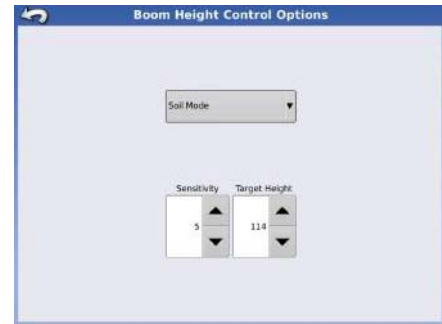

Boom Height Control Options Screen  
(Ag Leader)  
-Typical View

*\* Your monitor may vary in appearance, depending on model*

### Sensitivity

Sensitivity is how responsive the system is. The lower the number, the lower the sensitivity. The higher the number, the higher the response time and hydraulic demand.

*NOTE: Default sensitivity setting is 5.*

### On the Norac Pulse Monitor:

- Press the Settings Button (wrench icon) (located on the main “Run Screen”) to navigate to the Settings Screen.
- Press the Next Button (located next to “Sensitivity”) and increase or decrease system sensitivity values from 1-10.

### On the Ag Leader Monitor:

- Press the Boom Image (located on the main “Run Screen”).
- Press the Sensitivity Buttons (located on the Boom Height Control Options Screen) and increase or decrease system sensitivity values from 1-10.

### Target Height

Target Height is the height you desire the boom to be set at when spraying.

*NOTE: When operating in Soil Mode, the Target Height is measured from the spray nozzles to the soil. In Crop Mode, the target height is measured from the crop canopy to the spray nozzles.*

**On the Norac Pulse Monitor:**

- Press the Settings Button (wrench icon) (located on the main “Run Screen”) to navigate to the Settings Screen.
- Press the Next Button (located next to “Height”) and increase or decrease values to desired boom height.

**On the Ag Leader Monitor:**

- Press the Boom Image (located on the main “Run Screen”).
- Press the Target Height Buttons (located on the Boom Height Control Options Screen) and increase or decrease values to desired boom height.

**Further Information**

Refer to the Norac or Ag Leader manufacturer’s operation manual for complete operating/calibration instructions, troubleshooting information, and safety precautions.

Refer to “Specifications” provided in the *Introduction Section* of your machine operator’s manual for information on GPS dimensions on your machine.

---

---

**SPRAY BOOMS - 120/132’**

**-If Equipped**

The Spray Booms are controlled by an electro-hydraulic system. This system consists of operator-manipulated switches (located on the side console and the hydrostatic drive control handle) and hydraulic cylinders (attached to the booms), which provide lift, level, horizontal extension, and vertical extension.

 **CAUTION**

When operating or positioning the booms, observe the following safety precautions. Failure to comply may result in injury or equipment damage.

- Do not unfold/fold boom extensions when main boom is in cradle.
- Do not operate machine with one boom out of cradle and the other boom in cradle.
- Ensure booms are folded and in cradle before transporting the machine.

 **WARNING**

When operating or positioning the booms, observe the following safety precautions:

- Monitor both sides of the boom during fold procedure.
- Cradle booms when leaving the machine unattended.
- Ensure booms are folded when cradled.
- Select a safe area before unfolding/folding the booms.
- Clear area of personnel.
- Check for overhead obstructions.
- Do not unfold/fold booms near power lines. Contact with power lines can result in serious injury or death.
- Spray equipment is designed for FIELD USE ONLY. Do not attempt to use machinery for anything other than it’s intended purpose.

 **WARNING**

Hydraulic and electrical control systems are optimized for use of the spray boom attachment. Any modification to these systems may lead to unintended and uncontrolled motion. DO NOT install add-on control systems that are not approved by Hagie Manufacturing Company.

## Power Lines

Hagie Manufacturing Company cannot stress enough that extreme caution must be taken when operating equipment around power lines. Ensure there is more than sufficient clearance when transporting, unfolding and folding the boom, or spraying near power lines.



As a safety precaution, a Power Line Warning Message will appear on the Machine Display before extending the outer boom extensions or when operating in Auto Fold. Press ACKNOWLEDGE showing that you have acknowledged that there are no overhead power lines or obstructions before proceeding.

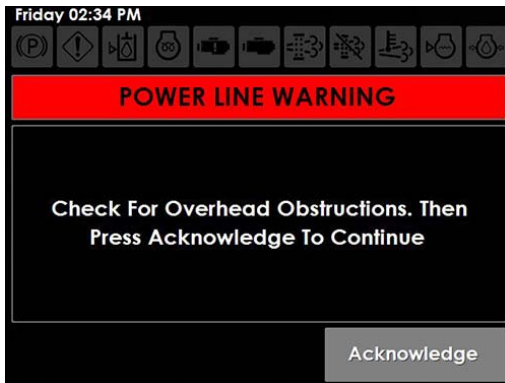

Power Line Warning Message  
(Located on the Machine Display)

Hydraulically folding the extensions of a 120 or 132-ft. Spray Boom, adjusting the spray valves, and recalibrating the spray system console essentially turns it into a 70-ft. boom. See the following diagrams for further information.



120/132-ft. spray width with  
boom fully extended\*



70-ft. spray width with boom folded  
at the 70/120/132-ft. extension fold

\* *Recommended spray width*

## Spray Boom Components

- Pivot Transom
- Fixed Transom
- Level Cylinders
- Roll Cylinder
- Proximity Sensors
- Norac® Sensors
- Position Sensors
- Accumulators
- Main Pivot/Breakaway Cylinders
- Outer Breakaway (Tip)

### Pivot Transom

The Pivot Transom houses work lights, solution valves, main fold cylinders, and solution plumbing.



Pivot Transom  
-Typical View

### Fixed Transom

The Fixed Transom and Lift Arm house the machine lift cylinders, pressure gauge, roll lock cylinders, boom stands, fold control

manifold, Hagie modules, Norac center sensor, and the Norac lift/level hydraulic manifold.



Fixed Transom  
-Typical View

### Level Cylinders

The Level Cylinders (located on the left and right-hand side of the transom) are responsible for the up and down movements of the boom when the level controls are activated.

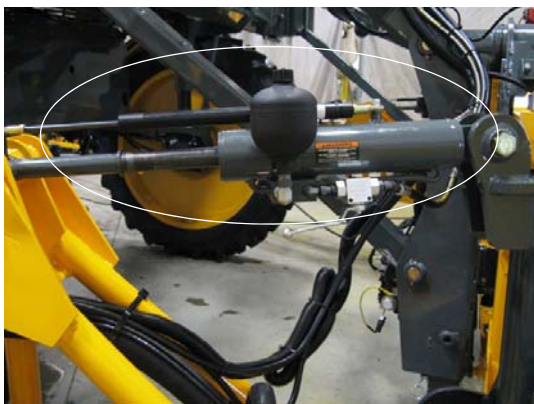

Level Cylinders  
-Typical View

### Roll Cylinder

The Roll Cylinders extend and retract to provide the “roll” functions to aid in re-centering the boom for transport.

The Roll Cylinders are automatically placed into a “passive roll state” when the main booms are in the UNFOLDED position. This means the booms will be free to move on

the pendulum pieces at this point. The hydraulic valves and cylinders will not be stopping this from occurring.



Roll Cylinder  
-Typical View

### Proximity Sensors

External Proximity Sensors are located at the 70-ft. fold. The motions of the boom (folding and unfolding) are guided by the measured position of the different cylinders.

*NOTE: The Proximity Sensors are factory-positioned and should not require calibration. Contact Hagie Customer Support if boom positioning assistance is needed.*



Proximity Sensors  
-Typical View



**Norac Sensors**

 <b>CAUTION</b>
<p>Placing an object beneath the Norac Sensors when the system is in automatic mode may result in unintended movement.</p>

The boom is equipped with five (5) Norac Sensors (two located at each folding section, two located on each outer boom extension, and one located on the transom) that measure boom height above ground. The sensors send a signal to the Norac control system allowing for position corrections to keep the boom parallel to the ground and the crop, giving you a more consistent spray pattern.



Norac Sensor  
-Typical View

**Position Sensors**

The level cylinders and main fold cylinders are equipped with Position Sensors. These sensors measure the linear stroke of the cylinder, allowing the boom to be positioned correctly when in Auto Fold mode.

The required specific motions exist to provide smooth, efficient operation. The programmed positions help prevent

mechanical damage to the boom due to severe imbalance, unintended contact with the ground, or improper fold sequence.

*NOTE: The Position Sensors are factory-positioned and should not require calibration. Contact Hagie Customer Support if boom positioning assistance is needed.*



Position Sensor  
-Typical View

**Accumulators**

 <b>WARNING</b>
<p>DO NOT remove accumulators from the transom. Failure to comply will result in catastrophic failure and will void the warranty.</p>

The level and lift cylinders (located on the transom) are equipped with multiple Accumulators. These Accumulators act as a “shock absorber” for the booms.



Accumulator  
-Typical View

### Main Pivot/Breakaway Cylinders

The Main Pivot/Breakaway Cylinders are responsible for the horizontal extension of the booms to the spray position. They also provide breakaway protection for the boom. These breakaway cylinders will move backward to a maximum of 45-degrees in the event that the section encounters an obstacle.



Main Pivot/Breakaway Cylinders  
-Typical View



### Outer Breakaway (Tip)

A “spring” breakaway (located at the tip of the boom) moves forward and backward to provide protection of the boom by allowing the boom to fold forward or backward in the event that it were to come into contact with another object.



Boom Breakaway  
-Typical View

*NOTE: The Outer Breakaway is self-resetting and will return to the normal operating position after it has cleared the hazard.*



### Recharging Breakaway Circuits

#### Main Pivot/Breakaway Cylinders (Auto/Manual Mode)

To recharge Breakaway Circuits in Auto/Manual Mode, press the corresponding Left or Right Boom Switch (located on the Hydrostatic Drive Control Handle) in the OUT position.

*NOTE: Right Extend OUT will recharge the breakaway circuits on the right-hand side of boom. Left Extend OUT will recharge the breakaway circuits on the left-hand side of boom.*

### Auto Fold

The Auto Fold feature is the preferred method for unfolding/folding the spray boom and makes operation of the machine easier for the operator.

*NOTE: Ensure the Hydrostatic Drive Control Handle is in the NEUTRAL position. If the machine is put in gear during fold operation, boom movement will stop.*

1. Press the Boom State Button (located on the Machine Display Auxiliary Controls Page) to the AUTO position.

*NOTE: The selected boom state will illuminate.*

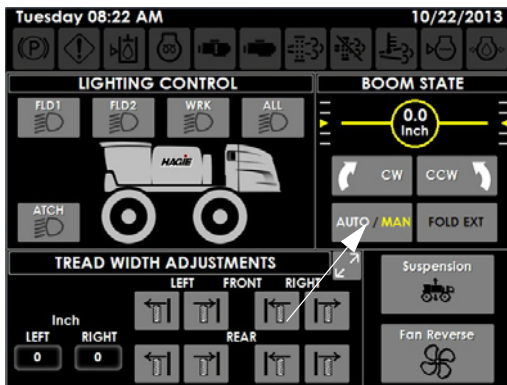

Boom State Button - Auto/Manual  
(Located on the Machine Display Auxiliary Controls Page)

2. Press the Fold Ext Button (located on the Machine Display Auxiliary Controls Page) to the ON (illuminated) position to enable Auto Fold operation of the outer boom extensions.

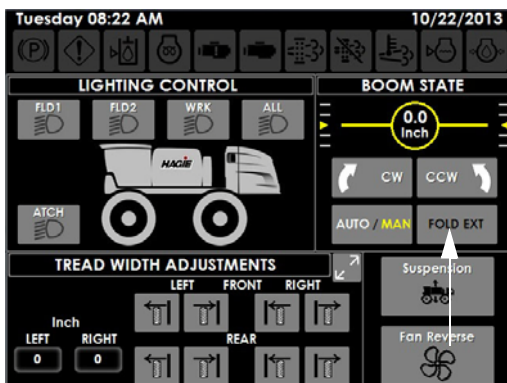

Fold Extension (Ext) Button  
(Located on the Machine Display Auxiliary Controls Page)

When the boom state displays AUTO and the Fold Ext Button is enabled, the boom will operate with the Boom Extension Switches (located on the side console).

*NOTE: When the Fold Ext Button is disabled, the main boom will unfold/fold, but the outer boom extensions will not.*

3. Press and hold **both** Left and Right Boom Extension Switches (located on the side console) UP to unfold the boom to the fully extended position on all sections.

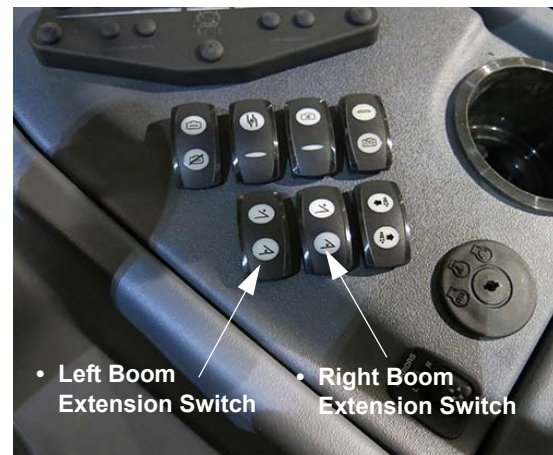

Left and Right Boom Extension Switches  
(Located on the side console)  
-Typical View

4. Press and hold **both** Left and Right Boom Extension Switches (located on the side console) DOWN to fold the boom in to the fully retracted position.

### Manual Unfold (OUT)

## NOTICE

Do not lower the main lift while the boom is in cradle. Failure to comply will result in property damage.



*NOTE: Ensure the Hydrostatic Drive Control Handle is in the NEUTRAL position. If the machine is put in gear during fold operation, boom movement will stop.*

1. Press the Boom State Button (located on the Machine Display Auxiliary Controls Page) to the MANUAL position.

*NOTE: The selected boom state will illuminate.*

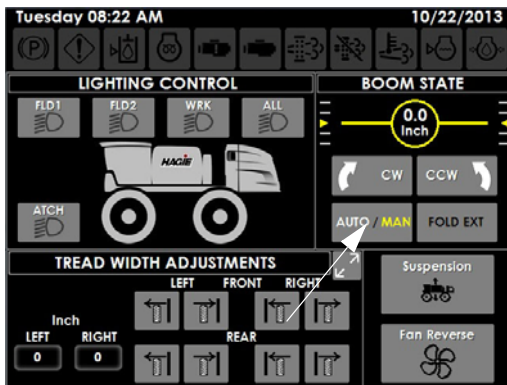

Boom State Button - Auto/Manual  
(Located on the Machine Display Auxiliary Controls Page)

2. Press and hold the Left and Right Boom Switches (located on the Hydrostatic Drive Control Handle) in the UP position to raise the level cylinders all the way up.



Left and Right Boom Switches  
(Located on the Hydrostatic Drive Control Handle)  
-Typical View

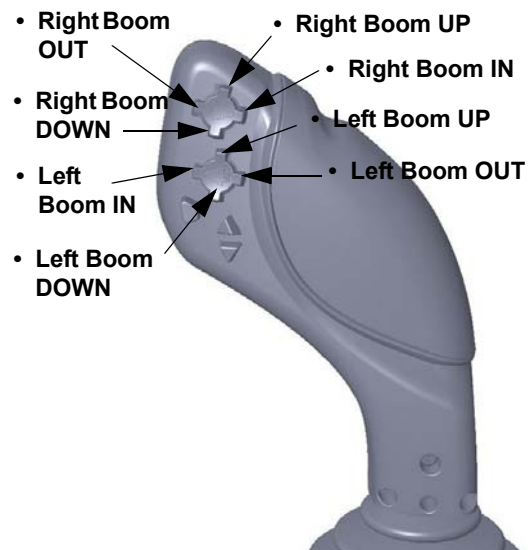

Left and Right Boom Switch Orientation  
-Typical View

3. Press and hold the Left and Right Boom Switches in the OUT position to unfold the main boom sections until they come to a complete stop.

*NOTE: Unfold booms simultaneously to prevent weight imbalance.*

4. Lower the level cylinders until the boom is parallel with the ground.

5. Press and hold the Left and Right Boom Extension Switches (located on the side console) in the UP position to unfold the boom extensions all the way OUT.

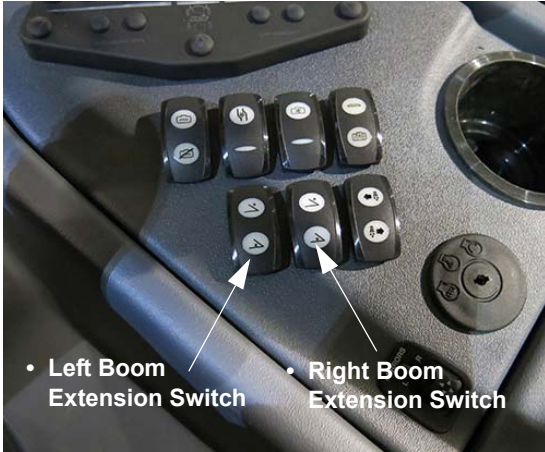

Left and Right Boom Extension Switches  
(Located on the side console)  
-Typical View

### Manual Fold (IN)

*NOTE: Ensure the Hydrostatic Drive Control Handle is in the NEUTRAL position. If the machine is put in gear during fold operation, boom movement will stop.*

1. Press the Boom State Button (located on the Machine Display Auxiliary Controls Page) to the MANUAL position.

*NOTE: The selected boom state will illuminate.*

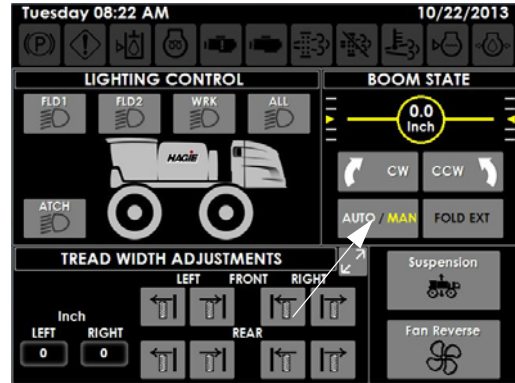

Boom State Button - Auto/Manual  
(Located on the Machine Display  
Auxiliary Controls Page)

2. Lower the level cylinders until the boom is parallel with the ground.
3. Press and hold the Left and Right Boom Extension Switches (located on the side console) in the DOWN position to fold the boom extensions all the way IN.

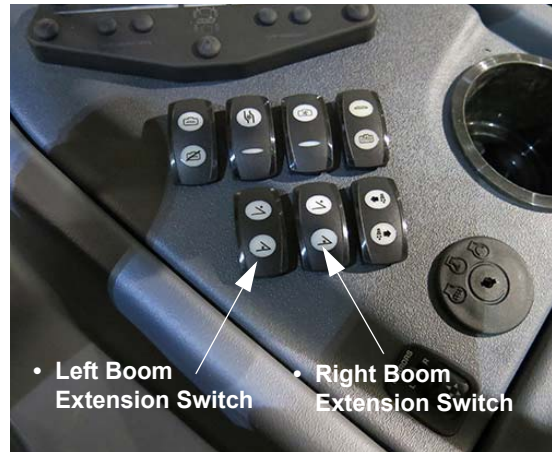

Left and Right Boom Extension Switches  
(Located on the side console)  
-Typical View

4. Raise the level cylinders all the way up.
5. Press and hold the corresponding Left and Right Boom Switches (located on the front side of the Hydrostatic Drive Control Handle) in the IN position until the main boom wings are aligned with cradles.

*NOTE: Fold booms simultaneously to prevent weight imbalance.*



Left and Right Boom Switches  
(Located on the Hydrostatic  
Drive Control Handle)  
-Typical View



Left and Right Boom Switch Orientation  
-Typical View

- Lower the level cylinders until the boom sections are seated in the boom cradles.

## Boom Alignment

When operating boom functions, the Boom Alignment value may be viewed on the Machine Display Auxiliary Controls Page.

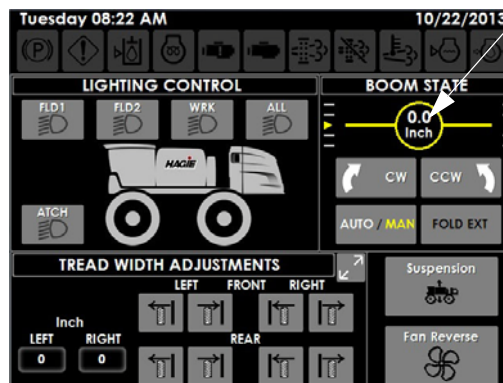

Boom Alignment Value  
(Located on the Machine Display  
Auxiliary Controls Page)

## Rolling Boom

The Rolling Boom feature will enable the boom to roll either “clockwise” or “counter-clockwise” (as viewed from the cab) using the Roll Command Buttons (located on the Machine Display Auxiliary Controls Page).

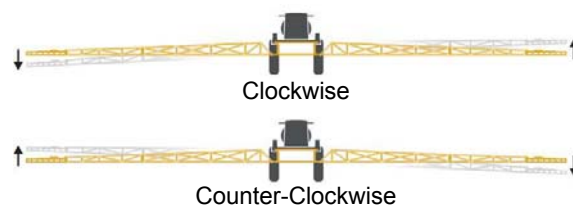

- Press and hold the “CW” Roll Command Button to roll the boom “clockwise”.
- Press and hold the “CCW” Roll Command Button to roll the boom “counter-clockwise”.

*NOTE: The Roll Command Buttons will illuminate when held in the ON position and the current boom alignment value will be displayed.*

- When either of the CW or CCW Roll Command Buttons are released, the boom will return to the neutral (center) position.

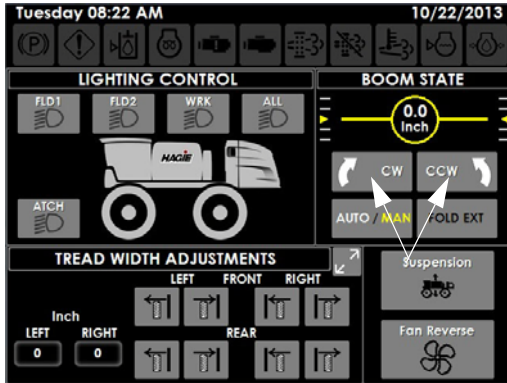

Roll Command Buttons (CW/CCW)  
(Located on the Machine Display  
Auxiliary Controls Page)

*NOTE: Center position value is 3.0 inches  
(7.6 cm).*

## Enabling/Disabling Norac® in the Pulse Display

### -If Equipped

*NOTE: Hagie Manufacturing Company  
recommends turning the Norac  
Monitor OFF when traveling from  
one field to the next. A power switch  
is located on the back side of the  
monitor.*



Norac Monitor  
-Typical View

- **To Enable**, press the corresponding Auto or Manual Button (located on the main “Run Screen”) to the ON (green illuminated position).

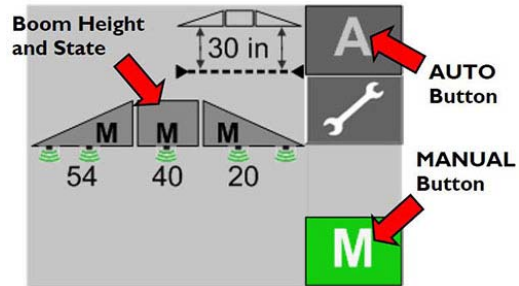

Auto/Manual Buttons - Norac  
(Located on the main “Run Screen”)  
-Typical View

*\* Your monitor may vary in  
appearance, depending on model*

- **To Disable**, press the corresponding Auto or Manual Button to the OFF (gray) position or press any one of the following boom control switches (located on the Hydrostatic Drive Control Handle):  
- Transom Switch (Up/Down)  
- Left or Right Boom Switch (Up/Down)

*NOTE: If the Norac System becomes  
inoperable, the Auto and Manual  
Fold functions will still operate.*

## Enabling/Disabling Norac in the Ag Leader® Display

### -If Equipped

- **To Enable**, press the Auto/Manual Button (located on the main “Run Screen”) to the ON (green illuminated position).

*NOTE: When the system is engaged, the  
boom image will change from black  
to blue.*





Auto/Manual Button - Ag Leader  
(Located on the main “Run Screen”)  
-Typical View

*\* Your monitor may vary in appearance, depending on model*

- **To Disable**, press the Auto/Manual Button to the OFF (white) position or press any one of the following boom control switches (located on the Hydrostatic Drive Control Handle):
  - Transom Switch (Up/Down)
  - Left or Right Boom Switch (Up/Down)

*NOTE: When the system is disabled, the boom image will change from blue to black.*

*NOTE: If the Norac System becomes inoperable, the Auto and Manual Fold functions will still operate.*

## Norac/Ag Leader System Settings

**-If Equipped  
(Soil/Crop Mode, Target Height, and Sensitivity)**

*NOTE: Settings may be adjusted through the main Run Screen by pressing the Boom Image or the Settings Button (wrench icon), depending on model. Refer to the Norac or Ag Leader manufacturer’s operation manual for further information.*

## Soil/Crop Mode

Soil Mode allows the sensors to read the height from the spray nozzles to the ground. Crop Mode allows the sensors to read the height from the spray nozzles to the top of the crop canopy.

### On the Norac Pulse Monitor:

- Press the Settings Button (wrench icon) (located on the main “Run Screen”) to navigate to the Settings Screen.
- Press the Next Button (located next to “Mode”) and select Soil, Crop, or Hybrid Mode.

*NOTE: Hybrid Mode is an improved Crop Mode, which uses a combination of the crop and oil readings to improve control. This setting is recommended in place of Crop Mode.*

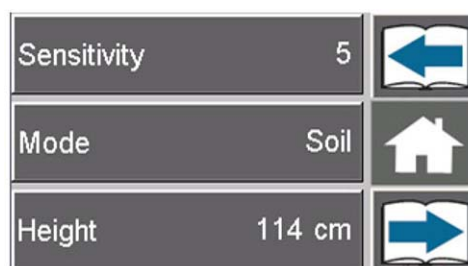

Settings Screen  
(Norac)

-Typical View

*\* Your monitor may vary in appearance, depending on model*

### On the Ag Leader Monitor:

- Press the Boom Image (located on the main “Run Screen”).
- Press the top drop-down arrow (located on the Boom Height Control Options Screen) and select Soil or Crop Mode.

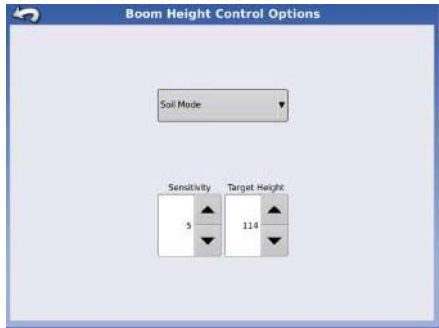

Boom Height Control Options Screen  
(Ag Leader)  
-Typical View

*\* Your monitor may vary in appearance, depending on model*

### Sensitivity

Sensitivity is how responsive the system is. The lower the number, the lower the sensitivity. The higher the number, the higher the response time and hydraulic demand.

*NOTE: Default sensitivity setting is 5.*

#### On the Norac Pulse Monitor:

- Press the Settings Button (wrench icon) (located on the main “Run Screen”) to navigate to the Settings Screen.
- Press the Next Button (located next to “Sensitivity”) and increase or decrease system sensitivity values from 1-10.

#### On the Ag Leader Monitor:

- Press the Boom Image (located on the main “Run Screen”).
- Press the Sensitivity Buttons (located on the Boom Height Control Options Screen) and increase or decrease system sensitivity values from 1-10.

### Target Height

Target Height is the height you desire the boom to be set at when spraying.

*NOTE: When operating in Soil Mode, the Target Height is measured from the spray nozzles to the soil. In Crop Mode, the target height is measured from the crop canopy to the spray nozzles.*

#### On the Norac Pulse Monitor:

- Press the Settings Button (wrench icon) (located on the main “Run Screen”) to navigate to the Settings Screen.
- Press the Next Button (located next to “Height”) and increase or decrease values to desired boom height.

#### On the Ag Leader Monitor:

- Press the Boom Image (located on the main “Run Screen”).
- Press the Target Height Buttons (located on the Boom Height Control Options Screen) and increase or decrease values to desired boom height.

### Further Information

Refer to the Norac or Ag Leader manufacturer’s operation manual for complete operating/calibration instructions, troubleshooting information, and safety precautions.

Refer to “Specifications” provided in the *Introduction Section* of your machine operator’s manual for information on GPS dimensions on your machine.

# BOOMS

## SECTION 4 – MAINTENANCE AND STORAGE

---

---

---

### SERVICE - LUBRICATION

#### NOTICE

Failure to properly lubricate pivot and friction points may result in unnecessary wear and damage.

### 90 and 100-ft. Booms

#### Transom Pivot Tubes

Lubricate the grease zerk on the Transom Pivot Tube - one on each side (that attaches the boom to the transom) every 50 hours of operation, or as needed.



Transom Pivot Tube  
-Typical View

#### Boom Fold

Lubricate the Boom Fold (where the main boom section connects to the boom extension) daily, or as needed.



Boom Fold  
-Typical View

#### Boom Breakaway

Lubricate the grease zerk on the Boom Breakaway daily, or as needed.



Boom Breakaway  
-Typical View

#### Boom Breakaway Cylinder Rod End

Lubricate the grease zerk on the Boom Breakaway Cylinder Rod Ends daily, or as needed.





Boom Breakaway Cylinder Rod End  
-Typical View

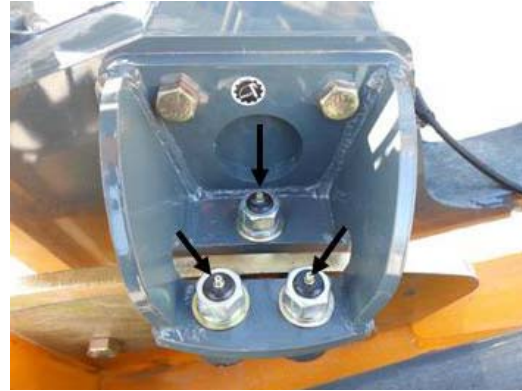

Roller Mount Assembly  
-Typical View

## 120 and 132-ft. Booms - If Equipped

### Pendulum

Lubricate the grease zerk on each Pendulum daily, or as needed.



Pendulum  
-Typical View

### Roller Mount Assembly

Lubricate the three (3) bearings on each Roller Mount Assembly daily, or as needed.

*NOTE: Failure to keep the rollers properly lubricated may result in roller seizure.*

### Pivot Transom

Lubricate the four (4) Pivot Transom grease zerks (located at the top and bottom of each Pivot Transom) every 50 hours of operation, or as needed.

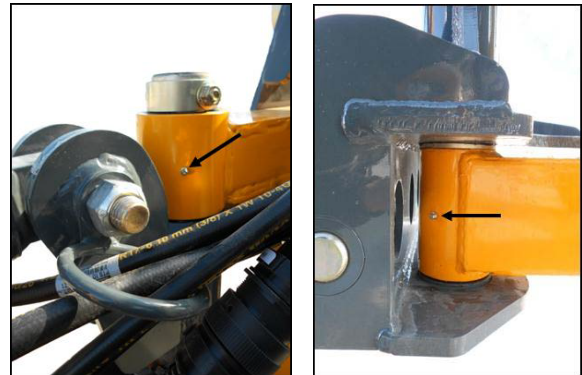

Pivot Transom  
-Typical View

### Pivot Transom Ball Joints

Lubricate the two (2) Pivot Transom Ball Joint grease zerks (located on the left and right-hand side of the Pivot Transom) every 25 hours of operation, or as needed.



Pivot Transom Ball Joints  
-Typical View



### Boom Adapter

Lubricate the two (2) grease zerks on each Boom Adapter every 25 hours of operation, or as needed.



Boom Adapter  
-Typical View



Boom Fold Linkages  
-Typical View

### Boom Fold Linkages

Lubricate the ten (10) grease zerks on the Boom Fold Linkages every 50 hours of operation, or as needed.

---

## SERVICE - MISCELLANEOUS

### Spray Booms

#### Nozzle Diaphragms

At the beginning of each season, remove each nozzle body cap (A) and inspect the diaphragm (B) for wear or fit. Replace diaphragms every 1,000 hours of operation, or as necessary.

**Spray Tips****CAUTION**

Never place a spray tip/nozzle to your mouth in an attempt to unplug it.

At the beginning of each season (or as required), remove a random sample of spray tip caps (C) and inspect the nozzle tips. If the tips are plugged or worn, clean or replace them. Replace spray tips every 1,000 hours of operation, or as necessary.



Nozzle Diaphragms and Spray Tips  
-Typical View

**Norac® Sensor Foam Pads**

Inspect the Norac Sensor Foam Pads daily. Remove the foam pad from each sensor, blow out with compressed air, and reinstall.

*NOTE: Ensure foam pads are clean and dry to ensure optimal performance.*

*NOTE: DO NOT blow the foam pad out while still installed on the sensor. Always remove foam pad before cleaning to avoid sensor damage.*



Norac Sensor Foam Pad  
(Located on the bottom  
of each Norac Sensor)  
-Typical View

Replace foam pads as necessary. Contact Hagle Customer Support for replacement.

**Friction Plates  
(120/132-ft. Spray Booms)****NOTICE**

Replace friction plates immediately if damaged. Failure to comply may cause the boom to “catch” during roll functions and result in system damage.

The Friction Plates (located in the bottom corners between the fixed transom and the pivot transom) require daily inspection for uneven wear and other damage.



Friction Plate  
(Located in the bottom corners between  
the fixed transom and pivot transom)  
-Typical View



**SERVICE INTERVALS**

<b>90/100' Spray Boom Service Intervals</b>				
<b>Service Point</b>	<b>Daily/ Before Each Use</b>	<b>As Required</b>	<b>50 Hrs.</b>	<b>1000 Hrs.</b>
Grease Boom Fold Lubrication Zerks	X			
Grease Boom Breakaway Lubrication Zerk	X			
Inspect/Clean Norac® Sensor Foam Pads	X			
Check Spray Nozzle Diaphragms and Tips		X		
Replace Norac Sensor Foam Pads			X	
Grease Boom Transom Pivot Tube Lubrication Zerks			X	
Change Spray Nozzle Diaphragms and Tips				X

<b>120/132' Spray Boom Service Intervals</b>					
<b>Service Point</b>	<b>Daily/ Before Each Use</b>	<b>Weekly</b>	<b>As Required</b>	<b>500 Hrs.</b>	<b>1000 Hrs.</b>
Grease Roller Mount Assembly Zerks	X				
Inspect/Clean Norac® Sensor Foam Pads	X				
Inspect Friction Plates (for wear)	X				
Grease Pendulum Zerks	X				
Grease Level Pin Adapter Plate Zerks		X			
Replace Norac Sensor Foam Pads			X		
Replace Worn Friction Plates			X		
Grease Pivot Transom Zerks			X		
Grease Pivot Transom Ball Joints			X		
Grease Boom Adapter Zerks			X		
Grease Boom Fold Linkage Zerks			X		
Check Spray Nozzle Diaphragms and Tips			X		
Replace Norac Manifold Hydraulic Filter				X	
Change Spray Nozzle Diaphragms and Tips					X

---

---

## STORAGE

### Preparing For Storage

1. Perform daily and weekly lubrication and maintenance inspections, as required.
2. With the engine at normal operating temperature, cycle all the hydraulic functions.
3. Thoroughly rinse the spray system.

*NOTE: Refer to your machine operator's manual for further information.*

4. Thoroughly wash the attachment and touch up any chipped or damaged paint.
5. Replace any damaged or missing decals.

*NOTE: Contact Hagie Customer Support for paint touch-up recommendations and decal replacement.*

6. Apply multi-purpose grease to hydraulic cylinder rods.
7. Refer to the spray system console manufacturer's operation manual for detailed information on monitor and flow meter storage procedures.
8. If the boom attachment will be stored separately, ensure that all open ends (e.g. hydraulic, electrical, solution, and foam marker, if equipped) are capped or covered with a suitable covering.

### Winterization Procedure

To winterize the boom, it is recommended that you use an environmentally safe type of antifreeze and water mixture that will give you adequate protection to -30 degrees.

Drain any remaining solution in the system and rinse thoroughly. Run antifreeze mixture through the system until it comes out all attachment openings.

## Removal From Storage

### NOTICE

Protective compounds such as grease can harden under exposure to weather conditions. Be sure to remove any dried grease and reapply new, if necessary.

1. Remove any dried grease from the cylinder rods and re-apply, if necessary.
2. Thoroughly clean the boom attachment.
3. Carefully unseal any openings that were sealed for storage.
4. Attach boom to the sprayer and manually cycle the hydraulics two or three times to adequately lubricate components.

# BOOMS

## SECTION 5 – MISCELLANEOUS

### TRANSPORTING

#### Transporting Your Machine with an Attachment

#### ⚠ CAUTION

Ensure there is adequate clearance when transporting the sprayer near an object with clearance less than the transporting height and width of the overall machine and boom attachment.

#### ⚠ CAUTION

Hagie Manufacturing Company does not recommend any form of transportation other than driving the sprayer. Loading the sprayer onto a trailer may result in sprayer rollover.

#### ⚠ WARNING

- Never operate the sprayer on a public roadway with solution in the tank.
- Never load or unload the sprayer with solution in the tank.
- Stopping the sprayer on trailer ramps may result in the sprayer to tip over.

#### ⚠ CAUTION

DO NOT operate the machine at speeds exceeding 20 mph (32 km/h) with solution in the tank. Operating speeds exceeding 20 mph (32 km/h) with a fully loaded tank may result in tire blow-out or wheel hub damage and will void the warranty.

#### ⚠ WARNING

When transporting the sprayer, observe the following to avoid serious injury or death:

- Check for adequate clearance before driving under any overhead obstructions.
- Contact with power lines may result in serious injury or death.



#### ⚠ CAUTION

Do not transport the machine without the booms folded and in cradle. Failure to comply may result in injury or equipment damage.

#### Cradling the Booms

**⚠ CAUTION**

Booms must be in FOLDED position when cradled. Failure to comply will result in property damage.

*NOTE: Always cradle the booms before traveling, transporting, or parking for an extended period of time.*

- Fold the outer boom extensions IN.
- Raise transom all the way UP.
- Fold main boom sections IN toward the machine.

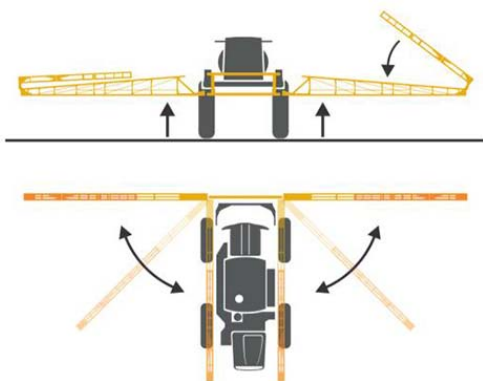

*NOTE: When boom reaches the last 8-10 degrees of travel, it will automatically slow down to avoid impact with the cradle.*

- Raise each individual boom until it clears the outer cradle stop.
- Fold the boom IN toward cradle back-stop.



- When boom touches the back-stop, lower until the full weight of the boom is resting in cradle.



**Loading**

**⚠ WARNING**

Keep all persons away from trailer when loading or unloading the sprayer. Failure to comply may result in serious injury or death.

**NOTICE**

Read and understand the trailer manufacturer's operation manual. Hitch the trailer to the pulling vehicle according to their recommendations.



**NOTICE**

The loaded height and width of the trailer must conform to state law in which it is being used. Do not exceed the trailer manufacturer's recommendations on loaded weight.

1. Pull the trailer to flat ground.
2. Apply the pulling vehicle's parking brake and turn the engine OFF.
3. Use tire chocks to keep the trailer from moving.
4. Fold the booms and lower into cradles.
5. Lower the trailer ramps and set the ramp spacing for the machine's tread width setting.
6. Have an attendant help guide you onto the trailer.
7. Allow enough room between the sprayer and the pulling vehicle for turning.
8. Secure the sprayer onto the trailer using the recommended securement restraints (see trailer manufacturer's operation manual).
9. Cover or remove the SMV (Slow Moving Vehicle) emblem when traveling over 25 mph (40 km/h).

**Unloading**

1. Pull the trailer to flat ground.
2. Apply the pulling vehicle's parking brake and turn the engine OFF.
3. Use tire chocks to keep the trailer from moving.
4. Lower the trailer ramps and set the ramp spacing for the machine's tread width setting.
5. Carefully release the securement restraints.
6. Have an attendant help guide you off of the trailer.
7. Uncover or replace the SMV (Slow Moving Vehicle) emblem.

**Towing****NOTICE**

Sprayer should never be towed under any circumstances. Machine damage will occur and will void the power train warranty.



Contact Hagie Customer Support if towing is unavoidable.

---

---

**QUICK-TACH SYSTEM -  
SPRAY BOOMS****⚠ CAUTION**

When operating or positioning the booms, observe the following safety precautions. Failure to comply may result in injury or equipment damage.

- Do not unfold/fold boom extensions when main boom is in cradle.
- Do not operate machine with one boom out of cradle and the other boom in cradle.
- Ensure booms are folded and in cradle before transporting the machine.

**⚠ WARNING**

When connecting or disconnecting the booms, observe the following safety precautions:

- Monitor both sides of the boom during fold procedure.
- Select a safe area before unfolding/folding the booms.
- Clear area of personnel.
- Check for overhead obstructions.
- Do not unfold or fold booms near power lines. Contact with power lines can result in serious injury or death.



**⚠ WARNING**

Turn the engine OFF before connecting/disconnecting any hoses or electrical lines. Failure to comply may result in serious injury or death.

**Connecting the Boom**

1. Square up to the boom.

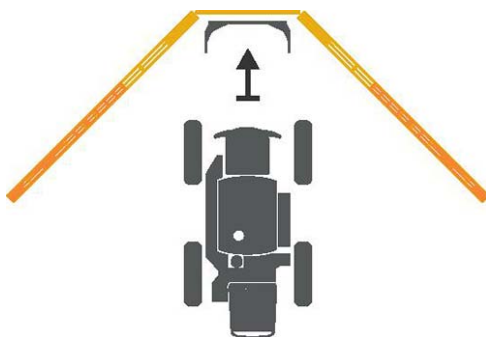

2. Disengage the Quick-Tach Lock Assemblies by pulling the Lock Pins (located on the front left and right-hand side of machine) OUT as far as it will go until it is in the “lock-out” position.

*NOTE: “Lock-out” position prevents re-locking while attaching or detaching the attachment.*

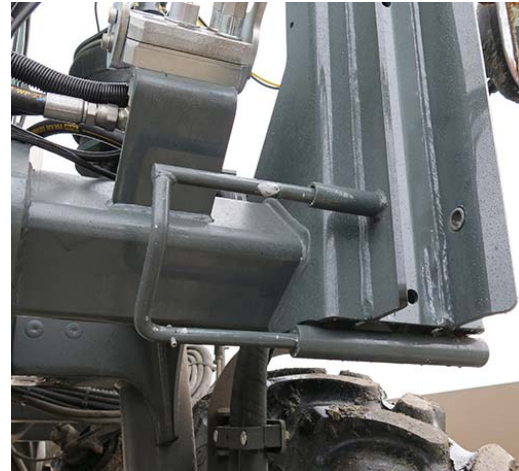

Lock Pin  
(Located on the front left and right-hand side of machine)  
-Typical View  
\* *Disengaged position shown*

3. Lower the machine by pressing the Suspension Button (located on the Machine Display Auxiliary Controls Page) to the ON (Deflate) position.

*NOTE: When the Suspension Button is pressed, a warning message will appear, alerting you that activating the Air Bags will change suspension height. Press OK to acknowledge. After you have acknowledged the suspension height warning, the Air Bags will deflate and the Suspension Button will illuminate.*

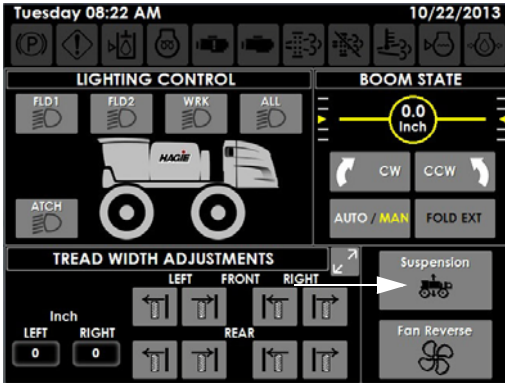

Suspension Button  
(Located on the Machine Display  
Auxiliary Controls Page)

4. Slowly pull into the attachment.
5. Ensure the Attachment Hooks are high enough to clear the Mounting Pins.



Attachment Clearing Mounting Pin  
-Typical View

6. Engage the parking brake.
7. **Turn the engine OFF before connecting any hoses or electrical lines!**
8. Connect all Solution, Foam Marker (if equipped), Hydraulic, and Electrical Connections.

### Solution Connection



Solution Connection  
(Located on the front  
right-hand side of machine)  
-Typical View

### Foam Marker Connection

-If Equipped

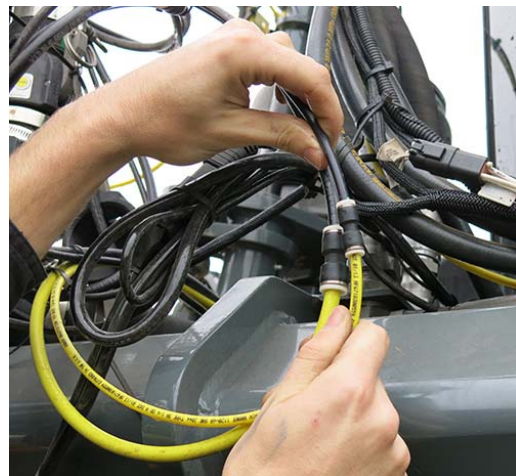

Foam Marker Connection  
(Located on the front  
right-hand side of machine)  
-Typical View



## Hydraulic and Electrical Connections

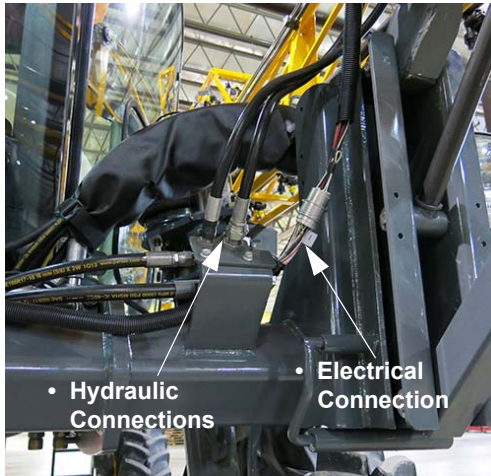

Hydraulic/Electrical Connections  
“Standard”  
(Located on the front  
left-hand side of machine)  
-Typical View

- **Electrical** - Connect machine and boom electrical hoses together. Ensure snap ring is secured.
- **Hydraulic** - Remove caps from machine and boom hydraulic connections. Connect hydraulic hoses together and tighten.



Electrical Snap Ring  
-Typical View

### Quick Connect Multi-Coupler -If Equipped

*NOTE: If your machine is not equipped with the Quick Connect Multi-Coupler, proceed to the next numbered step.*

- Install the Hydraulic/Electrical Connections (located on the left-hand side of attachment) into the Multi-Coupler Receptacle (located on front left-hand side of machine), ensuring full engagement.
- Push the Quick Connect Handle (located on the Hydraulic/Electric Multi-Coupler Assembly) UP to engage hydraulic/electrical connections.

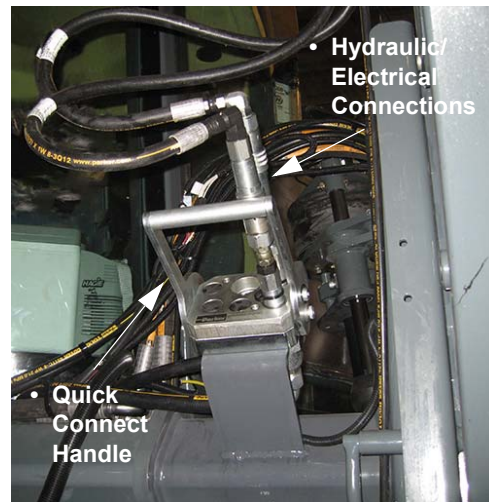

Hydraulic/Electric Multi-Coupler Assembly  
- If Equipped  
(Located on the front  
left-hand side of machine)

9. Rotate the NORAC Hand Valve - *if equipped* (located on the left and right-hand level cylinders) in the OPEN (counter-clockwise) position.





NORAC Hand Valve (2) - *if equipped*  
(Located on the left and  
right-hand level cylinders)  
-Typical View  
*\* Right-hand level cylinder shown*

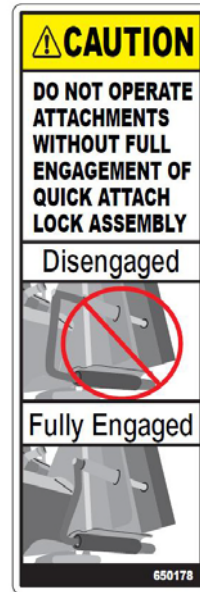

10. Start the engine.
11. Raise the machine by pressing the Suspension Button (located on the Machine Display Auxiliary Controls Page) to the OFF (Inflate) position.
12. Raise the boom until the Attachment Hooks fully engage.

*NOTE: Raising the attachment will allow the weight of the boom to pull the Attachment Hooks over the Mounting Pins. You will notice a change of weight as the machine begins to support the attachment.*

13. Engage the Quick-Tach Lock Assemblies by pushing the Lock Pins IN, ensuring full engagement.



Lock Pin  
-Typical View  
*\* Engaged position shown*

14. Place boom stands (if equipped) in the TRAVEL position by removing the lock pin and mounting bolt and sliding the leg all the way UP (on each side).

*NOTE: Reinstall the mounting bolts and lock pins to secure leg in the travel position (on each side).*

See “Boom Stands” elsewhere in this section for further information.

## NOTICE

Do not operate the boom while the boom stands are in the lowered position. Failure to comply may result in property damage.



Boom Stand in “Travel” Position  
-Typical View

### Disconnecting the Boom

Before disconnecting the boom, determine a proper storage location. When choosing a place to store the boom, there are three important things to keep in mind:

#### Is the ground level?

The ground must be level to help prevent the attachment from falling over. Level ground will also minimize stress on the frame of the attachment when in storage.

#### Is there enough space?

The attachment needs to be partially open for it to stand properly, but be aware of the room that is needed for the attachment and adequate space to travel around it safely.

#### Is it accessible?

The attachment needs to be positioned so you can connect easily. Ensure there is enough room and that the attachment is not blocked, or blocking other items.

If temporarily storing the attachment on a soft surface (such as grass), it is recommended to place blocks or wood beneath the stand’s feet to prevent the attachment from sinking into the ground.

*NOTE: It is NOT recommended to store the attachment on a soft surface for an extended period of time, due to the risk of settling soil, even when blocks or wood are used.*

1. Press and hold the corresponding Left and Right Boom Switches (located on the Hydrostatic Drive Control Handle) in the UP position to remove boom wings from cradles.



Left and Right Boom Switches  
(Located on the Hydrostatic  
Drive Control Handle)  
-Typical View



Left and Right Boom Switch Orientation  
-Typical View

2. Press and hold the corresponding Left and Right Boom Switches in the OUT position to unfold the boom wings until partially open.

*NOTE: Booms only need to be unfolded far enough to clear the boom cradles and lower. Do NOT fully extend.*

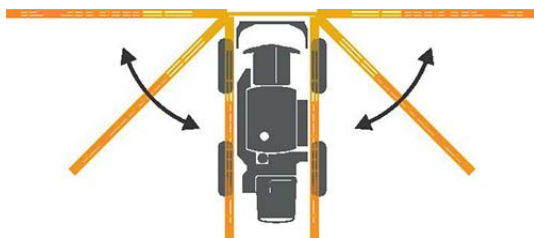

-Typical View

3. Press and hold the corresponding Left and Right Boom Switches in the DOWN position to point boom tips down.
4. Lower the boom and secure the boom stands (if equipped) in the DOWN position. See “Boom Stands” elsewhere in this section for further information.

**WARNING**

Lower boom to the ground before disengaging the Quick-Tach Lock Assemblies.

5. Disengage the Quick-Tach Lock Assemblies by pulling the Lock Pins (located on the front left and right-hand side of machine) OUT as far as it will go until it is in the “lock-out” position.

*NOTE: “Lock-out” position prevents re-locking while attaching or detaching the attachment.*

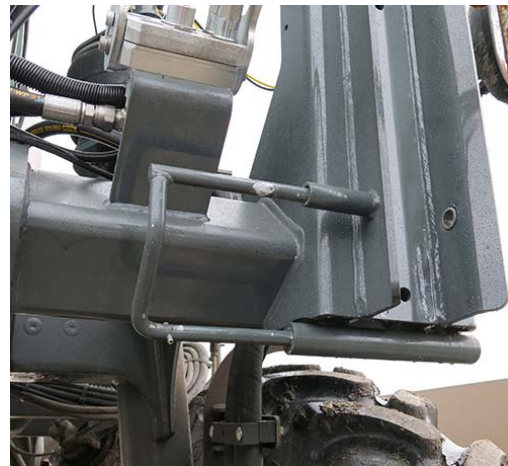

Lock Pin  
(Located on the front left and right-hand side of machine)  
-Typical View

*\* Disengaged position shown*

6. Lower the machine by pressing the Suspension Button (located on the Machine Display Auxiliary Controls Page) to the ON (Deflate) position.

*NOTE: When the Suspension Button is pressed, a warning message will appear, alerting you that activating*



*the Air Bags will change suspension height. Press OK to acknowledge. After you have acknowledged the suspension height warning, the Air Bags will deflate and the Suspension Button will illuminate.*

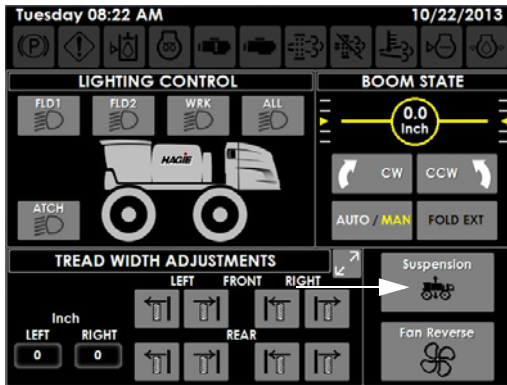

Suspension Button  
(Located on the Machine Display  
Auxiliary Controls Page)

7. Ensure the Boom Solution Valve Switches (located on the side console) are in the OFF position.



Boom Solution Valve Switches  
(Located on the side console)  
-Typical View

8. Disconnect the Solution and Foam Marker Connections (if equipped), ensuring not to leave the ends in an area where they may become damaged or contaminated.

### Solution Connection



Solution Connection  
(Located on the front  
right-hand side of machine)  
-Typical View

### Foam Marker Connection

-If Equipped

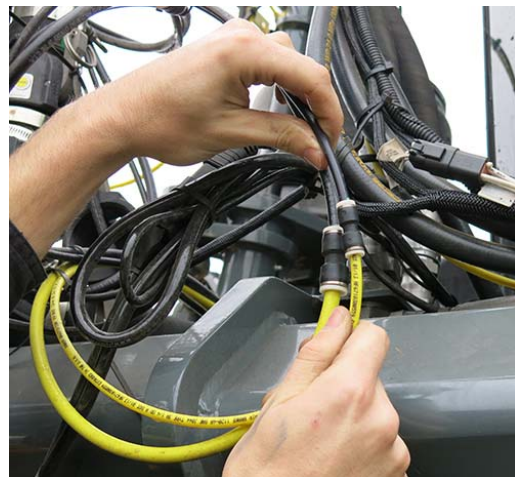

Foam Marker Connection  
(Located on the front  
right-hand side of machine)  
-Typical View

9. Press the Transom Switch (located on the Hydrostatic Drive Control Handle) in the DOWN position and slowly lower the boom/transom assembly until Attachment Hooks clear the Mounting Pins.





Transom Switch - DOWN  
(Located on the Hydrostatic  
Drive Control Handle)  
-Typical View

*NOTE: A “bounce back” effect may be felt when the weight of the boom has been relieved from the machine. Once the air bags have cycled, the machine will adjust to the new weight.*



Attachment Clearing Mounting Pin  
-Typical View

10. Engage the parking brake.
11. Turn the engine OFF before disconnecting any hoses or electrical lines!
12. Disconnect the Hydraulic/Electrical Connections (located on the front left-hand

side of machine), ensuring not to leave the ends in an area where they may become damaged or contaminated.

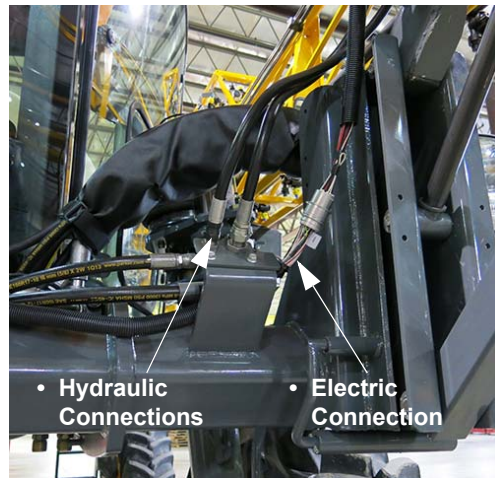

Hydraulic/Electrical Connections  
“Standard”  
(Located on the front  
left-hand side of machine)  
-Typical View

- **Electrical** - Loosen snap ring and disconnect electrical hoses.
- **Hydraulic** - Disconnect hydraulic hoses. Reinstall caps onto machine and boom hydraulic connections (if no other attachment will be installed).



Electrical Snap Ring  
-Typical View

*NOTE: Contact Hagie Customer Support for replacement caps.*

**⚠ CAUTION**

Ensure caps are reinstalled onto hydraulic connections before starting the machine (if no other attachment will be installed). Failure to comply will result in hydraulic oil to eject from connection points and possible hydraulic system contamination.

**Quick Connect Multi-Coupler Assembly -If Equipped**

*NOTE: If your machine is not equipped with the Quick Connect Multi-Coupler Assembly, proceed to the next numbered step.*

- Pull the Quick Connect Handle (located on the Hydraulic/Electric Multi-Coupler Assembly) DOWN to disengage hydraulic/electrical connections.
- Remove Hydraulic/Electrical Connections from the Multi-Coupler Receptacle.

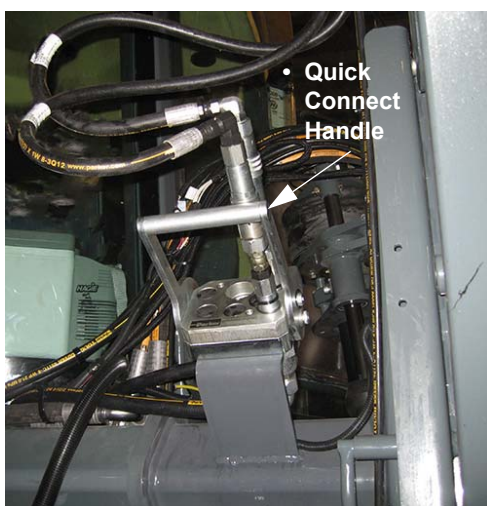

Hydraulic/Electric Multi-Coupler Assembly  
- If Equipped  
(Located on the front left-hand side of machine)

13. Rotate the NORAC Hand Valve - *if equipped* (located on the left and right-hand level cylinders) in the CLOSED (clockwise) position.

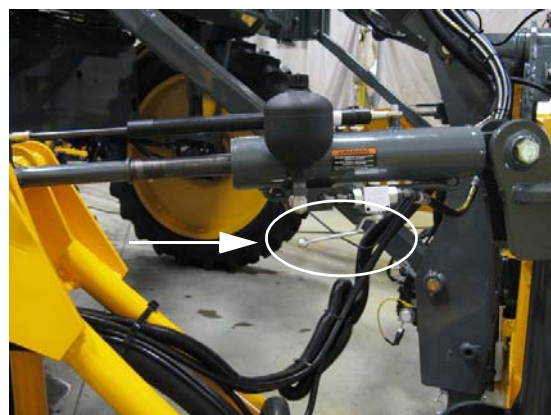

NORAC Hand Valve (2) - *if equipped*  
(Located on the left and right-hand level cylinders)  
-Typical View  
\* Right-hand level cylinder shown

14. If no other attachment is going to be installed, re-lock the Quick-Tach Lock Assemblies by pushing the Lock Pins IN.
15. Start the machine.
16. Disengage the parking brake and slowly back away from the boom.
17. Raise the machine by pressing the Suspension Button to the OFF (Inflate) position.

**Boom Stands**

**90' Spray Booms -If Equipped**

If your boom is equipped with boom stands, there will be two (2) located on the transom and one (1) located on each of the inner boom sections.

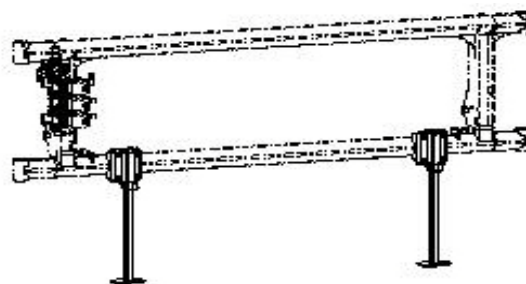

Booms Stands  
(90' Boom)  
-Typical View

Each boom stand has a leg with a “foot” on the bottom and a hex bolt in the top hole of the leg to secure it from sliding off, as well as a “snap” lock pin in the hole (located directly below the bracket) to maintain it’s position.

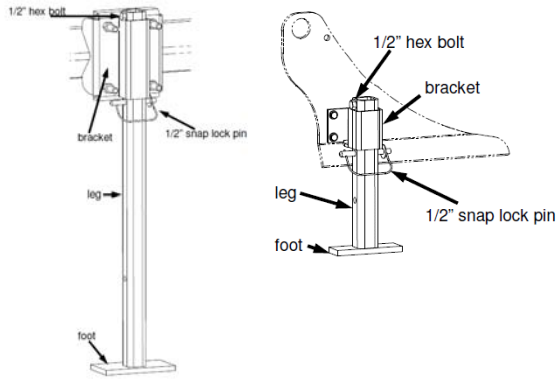

Boom Stand Assembly  
-Typical View

### 120/132' Spray Booms

Your boom is featured with two (2) boom stands (located on the transom).

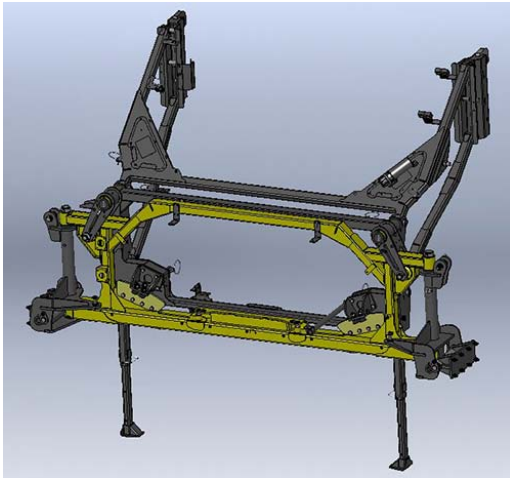

Booms Stands  
(120/132' Boom)  
-Typical View



Lock Pin  
(Located on the outer  
side of transom frame)  
-Typical View



Lock Pin Removed  
-Typical View

2. While supporting the bottom “foot” end of boom stand, remove the Mounting Bolt (located on the outer side of transom frame) and slowly lower boom stand to desired position.

### To Extend Booms Stands:

1. Remove Lock Pin (located on the outer side of transom frame) and set aside.





Mounting Bolt  
(Located on the outer  
side of transom frame)  
-Typical View

3. With the boom stand at desired position, reinstall the Mounting Bolt, ensuring the holes of the boom stand and transom frame are properly aligned.



Boom Stand  
(Extended position shown)  
-Typical View

4. Reinstall Lock Pin (that was previously removed in Step 1).
5. Repeat Steps 1-4 on opposite side of boom.

*NOTE: For additional adjustment, the “foot” end of the boom stand may also be adjusted to best suit your*

*situation (e.g. boom height, ground level, etc.) Adjust in the same manner as previously described.*

6. Reverse steps to store booms stands in “travel” position.

### Unfolding the Boom for Storage

The booms must be partially open for stability when unattached from the machine. Unfold the booms approximately 45-degrees while maintaining sufficient clearance for repositioning during reattachment. This position will allow the booms to sit level with the transom without causing excessive stress on either part. It will also keep the weight from shifting too much in either direction (rearward or forward), which could cause the boom to tip over and/or difficulty in connecting or disconnecting the attachment.

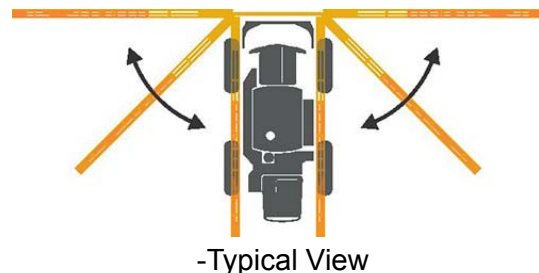

-Typical View



---

---

**TROUBLESHOOTING**

<b>Problem</b>	<b>Possible Cause</b>	<b>Suggested Remedy</b>
Boom sections will not fold in	<ul style="list-style-type: none"><li>• Operating the manual boom switches when boom state is in Auto Mode</li><li>• Position sensor error (Auto Mode is inoperable)</li></ul>	<ul style="list-style-type: none"><li>• Use the proper switches for the selected boom state</li><li>• Use manual boom switches</li><li>• Contact Hagie Customer Support for assistance</li></ul>
Boom will not recharge	<ul style="list-style-type: none"><li>• Proximity/Position Sensor error</li><li>• Software bug</li></ul>	<ul style="list-style-type: none"><li>• Check for error message on Machine Display</li><li>• Unfold each section in Manual Mode</li><li>• Contact Hagie Customer Support for assistance</li></ul>
Boom will not operate when manual boom switches are pressed	<ul style="list-style-type: none"><li>• Acknowledge power line warning on Machine Display</li></ul>	<ul style="list-style-type: none"><li>• Contact Hagie Customer Support if problem persists</li></ul>
Boom up/down functions inoperable	<ul style="list-style-type: none"><li>• Norac system not functioning properly/communication error</li></ul>	<ul style="list-style-type: none"><li>• Check Norac system status</li><li>• Restart machine</li><li>• Contact Hagie Customer Support if problem persists</li></ul>

# **BOOMS**

## INDEX

---

2014 Product Warranty .....	1-6
A Word From Hagie Manufacturing	
Company .....	1-1
About This Manual .....	1-1
Identification .....	1-3
Operator's Station .....	3-1
Quick-Tach System - Spray Booms .....	5-3
Safety Decals .....	2-3
Safety Messages Used In This Manual .....	1-2
Safety Precautions .....	2-1
Service - Lubrication .....	4-1
Service - Miscellaneous .....	4-3
Service and Assistance .....	1-2
Service Intervals .....	4-6
Specifications .....	1-4
Spray Booms - 120/132' .....	3-13
Spray Booms - 60/80/90/100' .....	3-5
Storage .....	4-7
Transporting .....	5-1
Troubleshooting .....	5-15

