



ANY PICTURES CONTAINED WITHIN THIS OPERATOR'S MANUAL THAT DEPICT SITUATIONS WITH SHIELDS, GUARDS, RAILS, OR LIDS REMOVED ARE FOR DEMONSTRATION PURPOSES ONLY. HAGIE MANUFACTURING COMPANY STRONGLY URGES THE OPERATOR TO KEEP ALL SHIELDS AND SAFETY DEVICES IN PLACE AT ALL TIMES.



**OPERATOR'S MANUAL
FOR
HAGIE 120ft BOOMS**

HAGIE MANUFACTURING COMPANY

721 CENTRAL AVENUE WEST
BOX 273
CLARION, IOWA 50525-0273

(515) 532-2861

COVERS 120ft BOOM ATTACHMENT OPTION NUMBERS: U61509

09-08 493463
12-08

© 2008 Hagie Manufacturing Company. Clarion, Iowa USA

ABBREVIATIONS

ACCUM	ACCUMULATOR	MIN	MINUTE
ADJ	ADJUST	M/F	MAINFRAME
ADPTR	ADAPTER	MPH	MILES PER HOUR
AMP	AMPERE	MT	MOUNT
APPROX	APPROXIMATELY	MTH	MONTH
ASSY	ASSEMBLY	MTR	MOTOR
AUX	AUXILIARY	NO	NUMBER
BRKT	BRACKET	OD	OUTSIDE DIAMETER
BTRY	BATTERY	POLY	POLYETHYLENE
C	CELSIUS	PRESS	PRESSURE
CAL	CALIBRATION	PRKNG	PARKING
CHEM	CHEMICAL	PROX	PROXIMITY
cm	CENTIMETER	PSI	POUNDS PER SQUARE INCH
CCW	COUNTERCLOCKWISE	QT	QUART
CW	CLOCKWISE	RAD	RADIATOR
CYL	CYLINDER	REC	RECOMMENDED
DIA	DIAGRAM	REQ	REQUIRED
DISPL	DISPLACEMENT	RPM	REVOLUTIONS PER MINUTE
EA	EACH	SEC	SECOND
ELECT	ELECTRIC	SERV	SERVICE
F	FAHRENHEIT	SOLE	SOLENOID
FIG	FIGURE	SOLU	SOLUTION
FRT	FRONT	SPEC	SPECIFICATION
FT	FOOT OR FEET	STRG	STEERING
GA	GAUGE	SQ	SQUARE
GAL	GALLON	TEMP	TEMPERATURE
GPA	GALLONS PER ACRE	TERM	TERMINAL
GPM	GALLONS PER MINUTE	VAR	VARIABLE
GPS	GLOBAL POSITIONING SATELLITE	V	VOLT
HAL	HALOGEN	VFC	VARIABLE FLOW CONTROL
HR	HOUR	VLV	VALVE
HYD	HYDRAULIC	W/	WITH
HYDRO	HYDROSTATIC	W/O	WITHOUT
ID	INSIDE DIAMETER	W	WEIGHT
IN	INCH	WD	WHEEL DRIVE
INFO	INFORMATION	WHL	WHEEL
Km/H	KILOMETERS PER HOUR	WK	WEEK
L	LITER (DISPLACEMENT)	WLD	WELDMENT
l	LITER (LIQUID)		
LB	POUND		
m	METER		
MAINT	MAINTENANCE		

TO THE OWNER



A WORD FROM HAGIE MANUFACTURING COMPANY

Congratulations on your selection of a Hagie 120ft Boom. We recommend that you study this Operator's Manual and become acquainted with the adjustments and operating procedures before attempting to operate your new attachment. As with any piece of equipment, certain operating procedures, service, and maintenance are required to keep it in top running condition.

We have attempted herein to cover all of the adjustments required to fit varying conditions. However, there may be times when special care must be considered.

Hagie Manufacturing Company reserves the right to make changes in the design and material of any subsequent attachment without obligation to existing units.

We thank you for choosing a Hagie 120ft Boom and assure you of our continued interest in its satisfactory operation for you. If we might be of assistance to you, please call us.

We are proud to have you as a customer.



TO THE OPERATOR

The following pages and illustrations will help you operate and service your new 120ft Boom. It is the responsibility of the user to read the Operator's Manual and comply with the safe correct operating procedures and lubricate and maintain the product according to the maintenance schedule.

The user is responsible for inspecting the attachment and having parts repaired or replaced when continued use of the product causes damage

or excessive wear to other parts.

Keep this manual in a convenient place for easy reference when problems arise. This manual is considered a permanent fixture with this machine. In the event of resale, this manual should accompany the attachment. If you do not understand any part of the manual or require additional information or service, contact the Hagie Customer Support Department:

Hagie Manufacturing Company
 721 Central Avenue West
 Box 273
 Clarion, IA 50525-0273
 (515) 532-2861



<p>The following symbols, found throughout this manual, alert you to potentially dangerous conditions to the operator, service personnel, or the equipment.</p>	
	<p><i>This symbol indicates a hazardous situation which, if not avoided, will result in death or serious injury.</i></p>
	<p><i>This symbol indicates a potentially hazardous situation which, if not avoided, could result in death or injury.</i></p>
	<p><i>This symbol indicates a potentially hazardous situation which, if not avoided, may result in minor or moderate injury. It may also be used to alert against unsafe practices.</i></p>

TABLE OF CONTENTS

I.	SAFETY/DECALS.....	1.1-1.9
II.	SPECIFICATIONS	2.1-2.3
III.	OPERATING SYSTEMS.....	3.1-3.19
	CAB CONTROLS	3.1
	BOOM	3.2-3.5
	OPERATING INSTRUCTIONS.....	3.6-3.19
IV.	CALIBRATION	4.1-4.3
	WET BOOM	4.1
	NORAC SYSTEM	4.2
	NORAC SENSORS.....	4.3
V.	TRANSPORTING	5.1-5.2
	DRIVING	5.1
	TRAILERING.....	5.2
VI.	SERVICE AND MAINTENANCE.....	6.1-6.3
	SERVICE POINT REFERENCES.....	6.1
	LUBRICATION.....	6.2-6.3
VIII.	STORAGE	7.1
IX.	TROUBLE SHOOTING.....	8.1-8.3
X.	LIMITED WARRANTY.....	9.1
IX.	INDEX.....	Index

I. SAFETY/DECALS

SAFETY PRECAUTIONS

Most accidents occur as the result of failure to follow simple and fundamental safety rules. For this reason, most accidents can be prevented by recognizing the real cause and doing something about it before the accident occurs.

Many conditions cannot be completely safeguarded against without interfering with efficient operation and/or reasonable accessibility. Therefore, you must study this Operator's Manual

and learn how to use the sprayer controls for safe operation. Likewise, do not let anyone operate without instruction.

Do not make modifications such as weldments, add-ons, adaptations, or changes from the original design of sprayer. Such changes and/or modifications may become safety hazards to you and to others and will void all warranties.

NOTE:

References to left-hand and right-hand used throughout this manual refers to the position when seated in the operator's seat facing forward.



SPRAYER BOOMS

- Cradle booms when leaving sprayer unattended.
- Make sure booms are folded in proper sequence before cradling.
- Select a safe area before unfolding booms. Avoid power lines and overhead structures.

GENERAL OPERATION SAFETY

- The hydraulic and electrical control systems are optimized for use with this attachment. Any modification to these systems may lead to unintended or uncontrolled motion. DO NOT install add-on control systems that are not approved by Hagie Manufacturing.
- Some conditions can not be completely safeguarded against without interfering with efficient operation of the machine and/or reasonable accessibility. In these cases decals have been installed to provide the operator with information on the hazard. DO NOT remove decals for any reason. If a decal is damaged, contact Hagie Customer Support Department for a replacement.

I. SAFETY/DECALS

BOOM LEVELING SYSTEM

- Unplug all cylinder sensors before welding on the machine or boom.

CHEMICAL HANDLING

- Never allow chemicals to come in contact with skin or eyes. Wear protective clothing or respirators as recommended by chemical manufacturer. Store this clothing outside of the cab so as not to contaminate filtered cab environment. Also, clean your boots to remove soil or other contaminated particles prior to entering cab.
- Never pour chemicals into an empty tank, fill tank half full of water first.
- Follow chemical manufacturer's instructions for mixing chemicals.
- Dispose of empty chemical containers properly.
- Wash spilled chemicals or spray residue from sprayer to prevent corrosion and deterioration.
- Select a safe area to fill, flush, calibrate, and clean sprayer where chemicals will not drift or run off to contaminate people, animals, vegetation, or water supply.
- Never place nozzle tips or other parts to one's lips in an attempt to unclog spray tip.
- Do not spray when wind is in excess of chemical manufacturer's recommended speed.
- Store pesticides in their original containers with label intact. Keep them in a separate, locked building.

GENERAL SAFETY

- Keep a fire extinguisher close at all times.
- Keep all shields in place.
- Keep clear of all moving parts and keep others away when operating.
- Do not wear loose fitting clothing that may be blown or drawn into moving parts.

I. SAFETY/DECALS

REPAIR/MAINTENANCE

HYDRAULICS

- Use caution when working with hydraulic fluid under pressure. Escaping hydraulic fluid can have sufficient force to penetrate your skin, causing serious injury. This fluid may also be hot enough to burn.
- Always lower load or relieve hydraulic pressure before repairing a hydraulic oil leak.
- Avoid torching, welding, and soldering near pressurized hydraulic lines.

GENERAL REPAIR/MAINTENANCE

- Turn off sprayer engine before checking, adjusting, repairing, lubricating, or cleaning any part of attachment.
- Disconnect battery ground cable and turn main battery switch off before servicing electrical system or welding on attachment.
- Unplug all cylinder sensors before welding on the machine or boom.

I. SAFETY/DECALS

⚠️ SPECIFIC SAFETY ISSUES TO BE AWARE OF:

- **POWER LINES:** The 120ft boom is longer than any other boom offered by Hagie Manufacturing, we can not stress enough that extreme caution must be observed when operating equipment around power lines! Be absolutely sure that there is more than sufficient clearance when transporting, opening the boom, or spraying around power lines!
- **DISABLING THE NORAC SYSTEM:** When using the Norac boom leveling system in auto mode it can be disabled to avoid a potentially hazardous situation. To disable the Norac system you can toggle the AUTO switch on the Norac console to manual or you can press any one of the following Hagie boom control switches: 90ft or 120ft vertical extension switch, lift (transom raise/lower), or the left or right level up/down. For information on the Hagie switches, refer to your sprayer manual. For information on the Norac switches, refer to your Norac manuals. For detailed information on trouble shooting, refer to the Norac manual.
- **OIL OVER AIR SCENARIOS:** Initially when a new cylinder is run on the machine, it should NEVER be connected to the booms on both ends. Only one end should be connected and then the air should be bled out of the cylinder by activating the cylinder in both directions to completion at least two times. Then when initially connecting the cylinder to allow full operation of the boom, be aware of the changes that have taken place and be ready for possible rapid movement if some air would possibly still be trapped in the cylinder. DO NOT ALLOW PEOPLE TO BE STANDING IN LOCATIONS WHERE THE BOOM COULD STRIKE THEM!

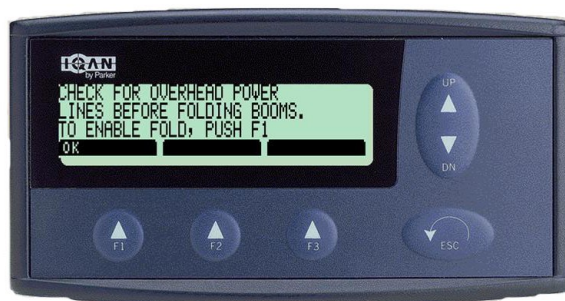

FIG 1.4-1



FIG 1.4-2

I. SAFETY/DECALS



- **CENTER BREAK-AWAY CYLINDER ON RE-CHARGE:** The center cylinder is set-up to be a break-away cylinder only, so it recharges automatically when told to through the program only after being enabled on the MDM. THIS SITUATION ALSO REQUIRES THE OPERATOR TO BE VERY ATTENTIVE TO THEIR SURROUNDINGS– MAKE SURE THAT NO ONE IS IN THE WAY OF THE BOOMS!



FIG 1.5-1

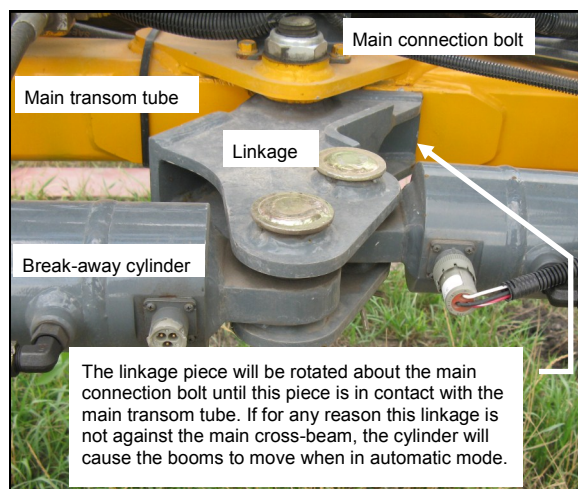

FIG 1.5-2

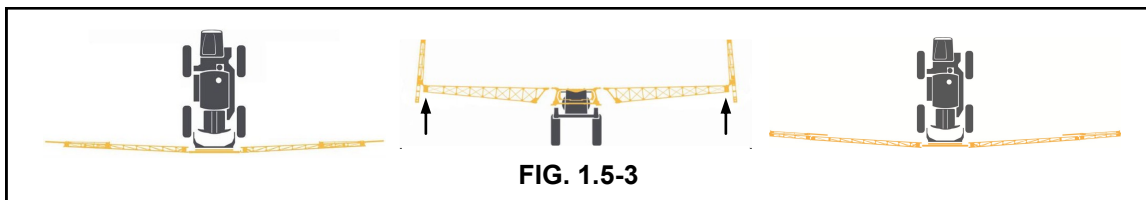

FIG. 1.5-3

- **COLD OIL SCENARIOS:** If the oil temperature is less than 50°F, the operator could experience some significant control loss on the 90ft fold cylinders. These cylinders are the main cylinders affected by over-running loads (see figure 1.5-3) due to the weight rotation of the boom during the fold in/out situation. When the oil is cold, the valve response is not as fast or as accurate. So when having to lift the weight the cylinder will move slower, but in trying to suspend the weight, the weight may cause faster movement because the valve is not dampening the flow like it normally would. THIS SITUATION ALSO REQUIRES THE OPERATOR TO MAKE SURE NO ONE IS AROUND THE BOOM DURING OPERATION!

I. SAFETY/DECALS

- **BOOM HEIGHT DURING TRANSPORT:** The fully up transport height (fig. 1.6-1) of the boom on the tractor with the 120ft design allows the boom to be higher than the rest of the machine. To remedy this, the wings **MUST** be raised, then the transom lowered to get the boom below the highest point of the cab, and then the wings lowered back into the cradles.



FIG 1.6-1

I. SAFETY/ DECALS

WARNING DECALS

Decals warning you of avoidable danger are located on various parts of the attachment. They are there for your personal safety and protection. DO NOT remove them. They will fracture upon attempted removal and therefore must be replaced.

Following are locations of important safety

decals. Replace them if they are torn or missing. All warning decals and other instructional Hagie decals may be purchased through Hagie Customer Support Department. To replace decals, be sure the installation area is clean and dry; decide on exact position before you remove the backing paper.

DECAL LOCATION

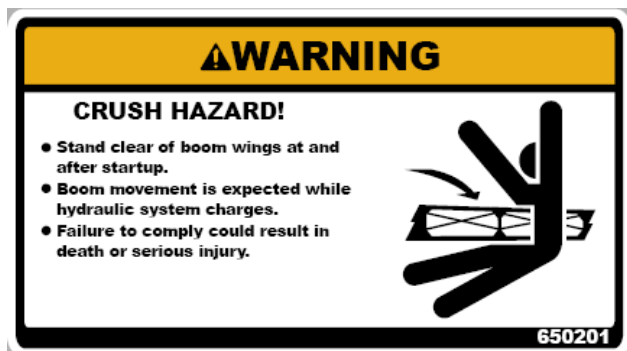

650201

(2) One on each 70 ft. fold section



650202

(2) One on each side of the transom



I. SAFETY/ DECALS



650203

(1) On the front of the rolling transom, left of the center valve.



650204

(4) One at each folding section along the boom.



650208

(1) On the Norac level valve



I. SAFETY/ DECALS



650210

(5) On each Norac sensor.



II. SPECIFICATIONS

A. BOOM WIDTHS

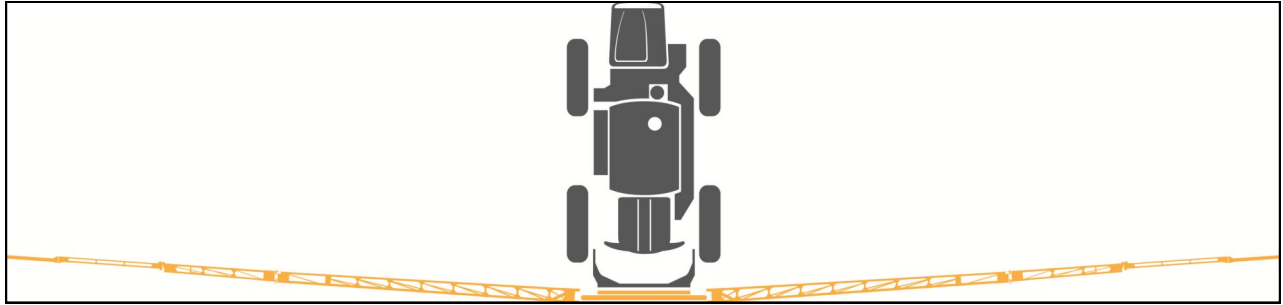

120ft spray width with boom fully extended*

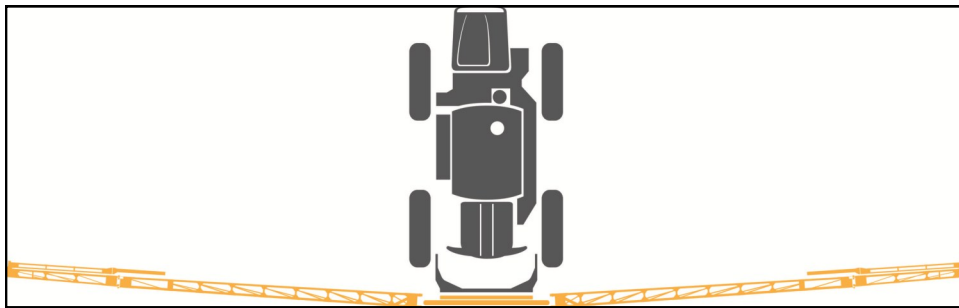

90ft spray width with boom folded at the 90/120 extension fold*

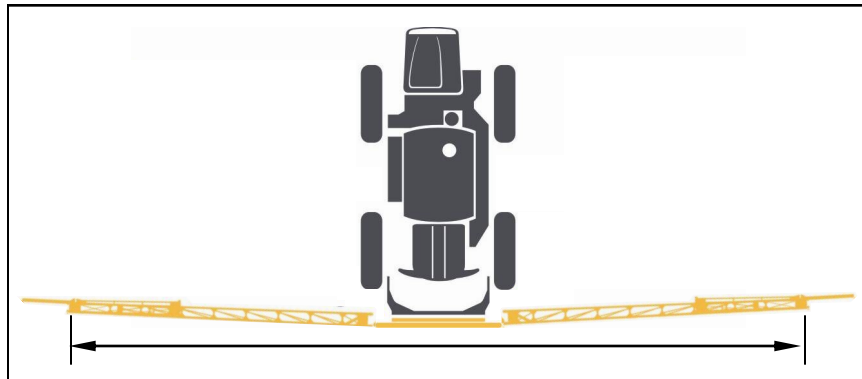

70ft width with boom folded at the 70ft extension fold

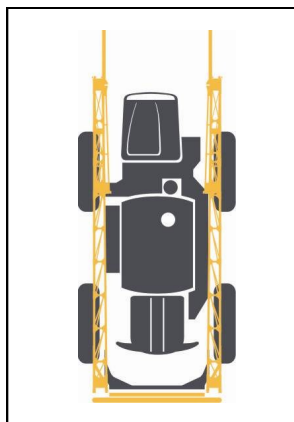

Transport width

*Recommended spray width

II. SPECIFICATIONS

B. BREAK-AWAY LOCATIONS

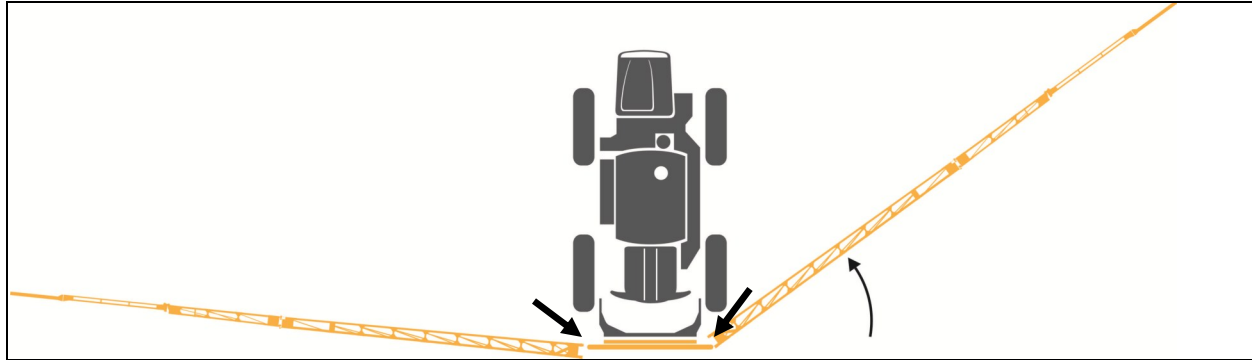

FIG. 2.2-1

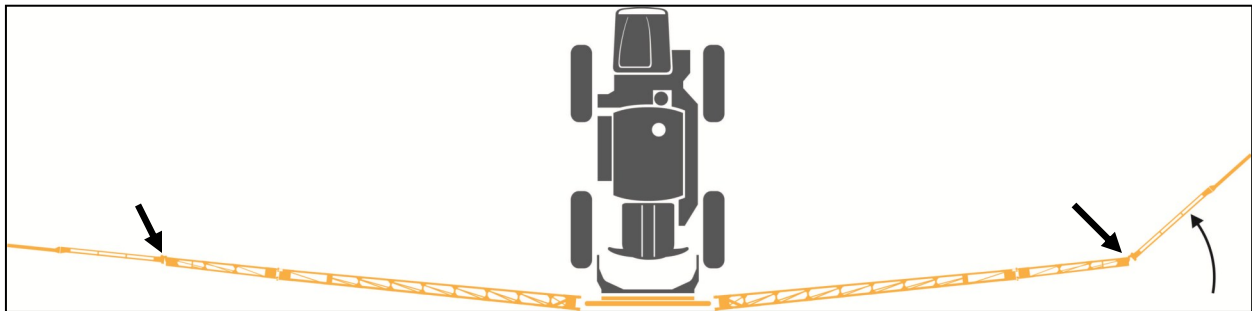

FIG. 2.2-2

The main pivot break-away (fig. 2.2-1) and the 90/120ft break-away provide the boom with structural protection. The main pivot break-away is also the accumulator circuit protection. That means that not only do you have structural protection at that point in the event that you catch something with the boom, but you also have protection from the booms' continued forward motion during a sudden or unexpected stop.

Figure 2.2-2 shows the break-away at the 90/120ft fold giving you protection if you were to catch the tip of the boom.

II. SPECIFICATIONS

C. SPRAY BOOMS

1. General

Type	Dry, with variable row spacing(optional wet)
Standard	90/120ft. (9 spray sections)
Controls.....	Electro-hydraulic: fold/lift/level
Outer boom tip hydraulic breakaway.....	Self-actuated, auto-reset hydraulic
Main pivot break-away.....	Self-actuated, auto-reset hydraulic
Pressure gauge	100 PSI glycerin filled (2)
Fence row nozzle.....	Two position, remote activated
Lift shock absorber	Gas charged accumulators (3)
Breakaway accumulators.....	Gas charged accumulators (4)
Transoms	Active roll and fixed

2. Electrical system

Auto-leveling sensors	Norac sensors (5)
Proximity sensors	(8)
Flasher/light harness*	12V flasher unit
	15 AMP fuse (6)
	40 AMP relay (4)
	3 AMP fuse (1)
Highway lights.....	Trapezoid glass (2)
Boom indicator lights*	Oval white LED (1)
	Oval amber LED (2)
	Oval red LED (9)
Level console.....	Norac UC4+
Solution valves.....	Electric ball valves

* Replaces similar part in a machine with a 90/100ft boom set-up.

III. OPERATING SYSTEMS

A. CAB CONTROLS



FIG 3.1-1

NORAC CONSOLE– The Norac console (fig. 3.1-1) is mounted to the right of the Raven Spray console. The Norac console controls the automatic boom leveling system. Read the Norac manual for complete operator instruction and trouble shooting information.

The Norac system includes a foot pedal for manual Hagie operation (fig. 3.1-2).



FIG 3.1-2



FIG 3.1-3

BOOM SOLUTION VALVE SWITCHES– In the cab of a machine with the 120ft boom, there are nine spray section switches. The operation of these switches is not different from the operation of the switches in a machine set up with a 80/90ft boom.

The switches operate the valves that control the flow of solution through the boom. The boom is divided into nine spray sections that can be individually turned on or off.



FIG 3.1-4

120ft BOOM EXTENSION SWITCH– The 120ft boom has another extension switch in addition to the 80/90/100ft extension switch. It controls the extension cylinder at the 90/120ft vertical fold.

This switch controls both the left and right booms and allows them to extend at the same time reducing the chance of an unbalanced load on the transom.



NEVER activate this function if you are near to overhead hazards such as power lines!

III. OPERATING SYSTEMS

B. THE BOOM



FIG 3.2-1

PIVOT (ROLLING) TRANSOM- The pivot transom (fig. 3.2-1) houses the Norac control valve, 2 work lights, 2 pivot valves, 1 solution valve, the center Norac sensor, the center boom stands, the horizontal extension and breakaway cylinders, 4 accumulators, the roll cylinder, and the center hydraulic manifold.



FIG 3.2-2

FIXED TRANSOM AND LIFT ARM- The fixed transom and lift arm house the flow meter, lift cylinders, 2 pressure gauges, 3 accumulators, the boom indicator light assembly, roll locks, and 3 IQAN modules.



FIG 3.2-3

THROTTLING VALVE- The throttling valve (fig. 3.2-3) is required to maintain back-pressure on the pump and keep the flow meter full if spraying at low flow rates and to aid in issues with precise flow control at low flow rates. If you require more assistance, contact Hagie Customer Service.

III. OPERATING SYSTEMS

B. THE BOOM



FIG 3.3-1

ROLL LOCKS-The roll locks (fig. 3.3-1), located on both the left and right side of the transom, are used to allow (or not) the active roll of the pivot transom.

The fully extended position (locked) should only be used during maintenance and storage situations. The fully retracted (active roll/ unlocked) position is the only position the roll locks should be in during the operation of the 120ft boom. Failure to retract the roll locks prior to operation may result in damage to the boom and auto-leveling system.



FIG 3.3-2

MAIN PIVOT/BREAKAWAY

CYLINDERS-The main pivot/breakaway cylinders (fig. 3.3-2) are responsible for the horizontal extension of the booms to the spray position. They also provide the break-away protection of the boom.



FIG 3.3-3

LEVEL CYLINDERS- The level cylinders (fig. 3.3-3), located on the left and right side of the transom, are responsible for the up and down movements of the boom when the level controls are activated. They are present on a 90/100ft boom although they are located at the top of the transom. Read the sprayer manual for more information on the level cylinder functions.

III. OPERATING SYSTEMS

B. THE BOOM



FIG 3.4-1

ROLL CYLINDER– The roll cylinder (fig. 3.4-1) extends and retracts to provide the “roll” functions of the Norac system.

The roll cylinder is activated automatically when the Norac is in auto mode or when the operator manually activates the roll functions through the Hagie controls.

The top portion of the cylinder (3.4-2, item A) provides the spring and shock functions. The bottom portion of the cylinder (3.4-2, item B) is the active portion.

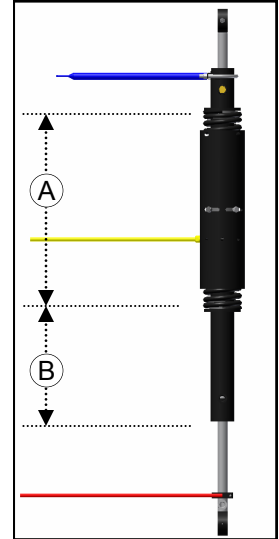

FIG 3.4-2



FIG 3.4-3

PROXIMITY SENSORS– There are external proximity sensors (fig. 3.4-3) located at the 70/90ft vertical fold and the 90/120ft vertical fold. The motions of the boom (folding and unfolding) are guided by the measured position of the different cylinders.

POSITION SENSORS– The main pivot/breakaway cylinders, lift cylinders, and level cylinders are equipped with internal (fig. 3.4-4) position sensors. The sensors measure the position of the rod inside of the cylinder and provide the system with

position information to aid the operator in making sure that the boom is in the correct position to perform many of its functions. This allows the machine control system to achieve a much finer degree of control over boom motion. The information can be viewed on the MDM.

The required specific motions exist to provide smooth, efficient operation. The programmed positions help prevent mechanical damage to the boom due to severe imbalance, unintended contact with the ground, or improper fold sequence.

The sensors are positioned at the factory and should not require any calibration. If you experience issues with the positioning of the boom, contact Hagie Customer Service for assistance.



FIG 3.4-4

III. OPERATING SYSTEMS

B. THE BOOM



FIG 3.5-1

90/120ft BREAKAWAY- There is a hydraulic breakaway (fig. 3.5-1) at the 90/120ft fold section. The breakaway provides protection to the boom by allowing the boom to fold if it were to come into contact with another object.



FIG 3.5-2

HIGHWAY LIGHTS- The work lights that are located on the quick attach mounts for a 90ft or 100ft boom are mounted onto the 120ft boom (fig. 3.5-2). They are located on the rolling transom. These lights come on when the HIGHWAY LIGHT switch is activated on the steering console.



FIG 3.5-3

NORAC SENSOR- The boom is equipped with 5 Norac sensors (fig. 3.5-3) that track the boom's position to the ground. They send signals to the hydraulic system allowing for position corrections to keep the boom parallel to the ground and the crop giving you a more consistent spray pattern.

III. OPERATING SYSTEMS

C. OPERATING INSTRUCTIONS

⚠ DANGER! Before proceeding, check the area around the machine for by-standers, overhead objects, or power lines. Failure to do so will result in death or severe injury.

NOTICE: The purpose of this manual is to guide you in operating the 120ft boom. Please be sure to read this manual along with the sprayer's operator's manual and all other manuals that are included with the machine. This manual is only intended to cover the 120ft boom attachment and any differences in the operation of the sprayer's controls, it will not give complete instruction on the operation of basic functions that are already discussed in the sprayer's manual.

UNFOLDING THE BOOMS FROM THE CRADLED POSITION:

1. The hydrostatic lever must be in the neutral position. (fig. 3.6-1)
2. Make sure the transom is all the way up. To raise the transom, press RAISE on the square rocker switch on the hydrostatic lever. (fig. 3.6-2,fig. 3.6-3)

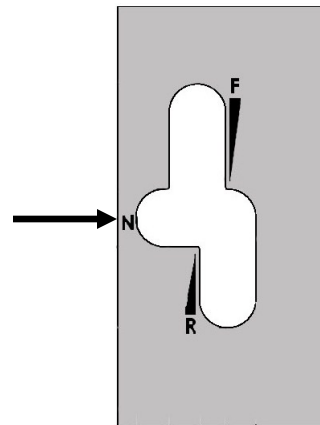

FIG 3.6-1



FIG 3.6-2



FIG 3.6-3

III. OPERATING SYSTEMS

C. OPERATING INSTRUCTIONS

3. Raise both level cylinders up (fig. 3.7-2) with the level controls on the hydrostatic lever (fig. 3.7-1) until motion stops (this will be in the range of 6.75 to 7.5 inches of cylinder extension). Following this step ensures that the level cylinders are in the correct position to unfold the 90ft boom later in your sequence. NOTE: While moving the level cylinders, you can view their position on the MDM display.



FIG 3.7-1



FIG 3.7-2

4. Extend both the left and right main boom sections (fig. 3.7-3) using the horizontal extension switches on the hydrostatic lever (fig. 3.7-4). It is important that both booms are unfolded at the same time to prevent an unbalanced load on the transom. NOTE: Boom motion slows near the end of travel; make sure the boom has stopped moving completely (full extension should be 19.2 inches of cylinder extension) to ensure the boom stops in the “spray position”. You can view the position of the booms on the MDM display as you could with the level positions.



FIG 3.7-3



FIG 3.7-4

III. OPERATING SYSTEMS

C. OPERATING INSTRUCTIONS

5. Unfolding the 90ft section (fig. 3.8-2) requires that the following conditions be met:

1. Push the 90ft BOOM EXTENSION button
On the side console (fig. 3.8-1)
2. The main booms are fully extended to the spray position (see step 4 above)
3. Both boom level cylinders are extended past 6.5 inches. (see step 3 above)
4. The 120ft sections are fully folded in.
5. The power line message on the MDM has been acknowledged.

6. Unfold the 120ft section (fig. 3.8-5) by pressing OUT on the 120 BOOM EXTENSION switch on the side console (fig. 3.8-3). Continue to press until the boom is completely unfolded! NOTE: The 90ft section must be completely unfolded before the 120ft section will unfold (fig. 3.8-4).



FIG 3.8-1



FIG 3.8-2



FIG 3.8-4



FIG 3.8-3



FIG 3.8-5

III. OPERATING SYSTEMS

C. OPERATING INSTRUCTIONS

CRADLING THE BOOMS:

1. The hydrostatic lever must be in neutral (fig. 3.9-1).
2. If you are coming from the field, try to be on level ground before de-activating the Norac system (fig. 3.9-2). If you notice that the transom rolled one way or the other (fig. 3.9-3) you will need to manually roll the transom back before continuing. To manually roll the transom follow these steps:

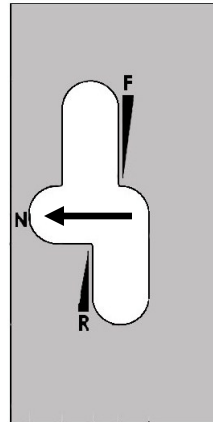

FIG 3.9-1



FIG 3.9-2

1. Make sure you are away from power lines or any overhead obstructions.
2. Raise both level cylinders to above 10 in. The MDM will guide you.
3. Depress the foot pedal switch (fig. 3.9-4).
4. Simultaneously activate the left level up and the right level down (fig. 3.9-5) to roll the transom clockwise. If you need to roll the transom counterclockwise, depress the left level down and the right level up. (fig. 3.9-6)



FIG 3.9-3



FIG 3.9-4



FIG 3.9-5

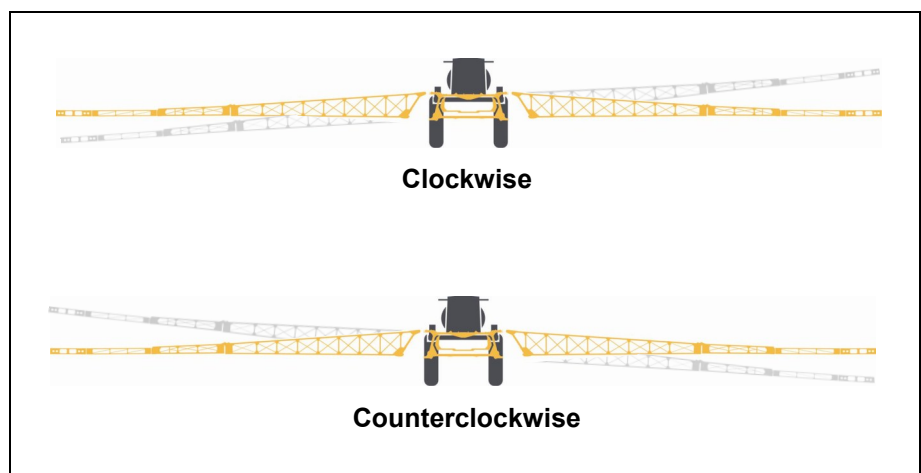

FIG 3.9-6

III. OPERATING SYSTEMS

C. OPERATING INSTRUCTIONS

3. Fold the 120ft section by pressing IN on the 120ft BOOM EXTENSION switch on the side console. Continue to hold the switch until the boom section is all the way in. (fig.3.10-2) NOTE: The booms have to be fully extended in the spray position to fold the 120ft section.



FIG 3.10-2

4. Raise your left and right levels to a MDM display reading between 6.5 in. and 7.0 in.. Fold the 90ft section (fig. 3.10-4) in by pressing IN on the 90 BOOM EXTENSION switch and holding until they are all the way in.(fig. 3.10-3) NOTE: The booms must be in the spray position to fold the 90ft section. BE SURE that you are not around any power lines before the message is acknowledged in the MDM by pressing F1 (OK).



FIG 3.10-4

5. Raise the transom all the way up. (fig. 3.10-5)



FIG 3.10-1

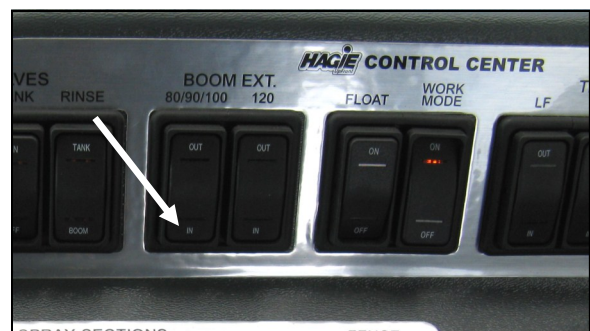

FIG 3.10-3



FIG 3.10-5

III. OPERATING SYSTEMS

C. OPERATING INSTRUCTIONS

6. Fold both main boom sections in by pressing IN on the hydrostatic lever. (fig. 3.11-1) Be sure that they are being folded in at the same time to keep a balanced load on the transom (3.11-2).

-Once the boom is against its respective cradle (fig. 3.11-3) lower each level cylinder until the movement stops and the boom is sitting in the cradle (fig 3.11-4).



FIG 3.11-1



FIG 3.11-2



FIG 3.11-3



FIG 3.11-4

III. OPERATING SYSTEMS

C. OPERATING INSTRUCTIONS

OPERATING THE BOOM WITH THE NORAC BOOM LEVELING SYSTEM

MAKE SURE THE ROLL LOCKS ARE OUT OF THE LOCKED POSITION (fig. 3.12-2) BEFORE TRYING TO USE THE NORAC CONTROLLER. REFER TO THE NORAC OPERATING MANUAL FOR INITIAL CONTROLLER SET-UP.

1. Lower the transom into the range of the desired spray height. The booms should be fairly level (3.12-1).
2. Turn the NORAC controller on and engage the control by toggling the auto/manual switch to auto. **PAY ATTENTION!** The system will move the booms to the programmed spray height and level the booms!
3. Auto boom control can be cancelled by selecting manual on the NORAC controller or activating any of the boom hydraulic functions using the Hagie control switches. To restart auto control, repeat step 2.



FIG 3.12-1



FIG 3.12-2



FIG 3.12-3

III. OPERATING SYSTEMS

C. OPERATING INSTRUCTIONS

Quick attach: Disconnecting the boom



FIG 3.13-1

1. Locate the boom on a level, flat, hard surface. To prevent stress on the boom frame and joints it is best that the boom be placed on a surface that is fairly level and flat. To prevent the boom from sinking into the ground the surface should be solid.

Remember that the boom must be partially open while off the machine! Choose an area that will not be an inconvenience to get around and still protect the boom from damage.



FIG 3.13-2

2. Remove the booms from the cradles. The booms only need to be opened far enough to be able to lower them, they do not need to be fully opened into the spray position.



FIG 3.13-3

3. Position the booms as shown in figure 3.13-3. This position is located between 7 and 12 inches of horizontal extension on your MDM. This is the best position for the booms to be in while they are off the machine because it provides stability while trying to conserve space.



FIG 3.13-4

4. Lower the boom to access the boom stands at the bottom of the rolling transom and the roll locks. The transom must be lowered to a level in which you are able to access it. It is also very important that it be close to the ground when you disengage the quick attach lock pins later in the process.

III. OPERATING SYSTEMS

C. OPERATING INSTRUCTIONS



FIG 3.14-1

5. Extend the roll locks. This step is extremely important! NEVER attempt to remove the boom or perform any maintenance on the boom without extending the roll locks to the “locked” position. Failure to do this step may result in injury or damage to the boom.

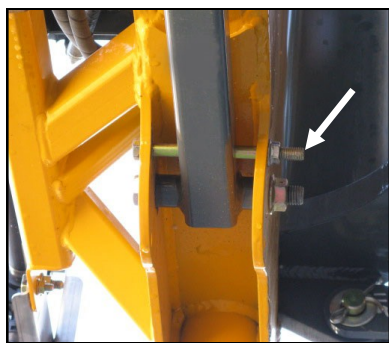

FIG 3.14-2

6. Remove the fastener and pivot leg stands 90° to lower. Remove the bolt (fig. 3.14-2) to allow the leg stands to pivot. Re-insert the bolt through the lower hole to keep the leg stand from folding up.

7. Lower the legs to the ground. If necessary, place blocks under the leg stands where they will rest on the ground (fig. 3.14-3). This

will help to keep them from sinking into a soft surface such as grass or soil.



FIG 3.14-3



FIG 3.14-4

8. Lower the LH and RH wings on to an elevated object. Use the right and left level functions to lower the wings to an elevated object such as a pallet (fig. 3.14-4) or 6x6 timber (fig. 3.14-5).



FIG 3.14-5

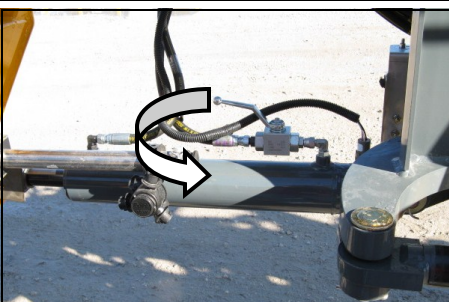

FIG 3.14-6

9. Turn OFF the shut off valves on the level cylinders. The level cylinders are equipped with valves that keep the hydraulic fluid from leaking out of the level cylinder. They must be turned so that they are perpendicular to the valve.

III. OPERATING SYSTEMS

C. OPERATING INSTRUCTIONS



FIG 3.15-1

10. Open the quick attach lock assemblies. If you have followed the previous steps, your boom should already be located in position to unlock the quick attach lock assemblies. **DO NOT** open the lock assemblies with the boom in the air!

To open the assemblies, simply pull the handle (fig. 3.15-1) toward the center of the machine. Be sure that they do not re-lock while attempting to remove the boom in the next step.



FIG 3.15-2

11. Lower the transom to raise the quick attach hooks off of the quick attach pins. Lower the transom until the hooks have cleared the pins (fig. 3.15-2).

You may notice a “bounce back” effect when the weight of the boom has been relieved from the machine. Once the airbags have cycled the machine will adjust to the new weight.

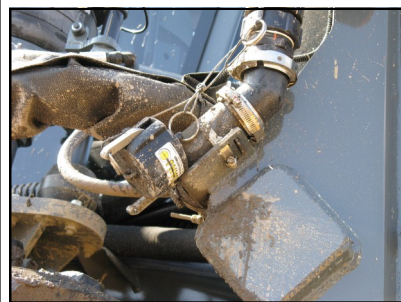

FIG 3.15-3

12. Disconnect solution and foam marker hoses. Disconnect the solution hose (fig. 3.15-3) on the right side of the machine. Disconnect the foam marker hoses (fig. 3.15-4, item A) and the rear nozzles (fig. 3.15-4, item B) at the right front of the machine.

Be sure to cap the hoses with the supplied caps. If the caps are missing, cover the opening with plastic and tape until a replacement can be obtained from Hagie Customer Service.

The foam marker hoses are capable of being connected to each other. Do not attempt to connect hoses from different systems together.

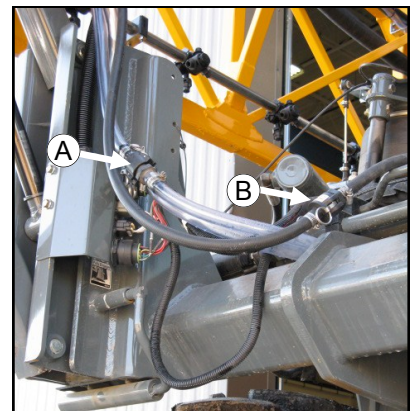

FIG 3.15-4

III. OPERATING SYSTEMS

C. OPERATING INSTRUCTIONS

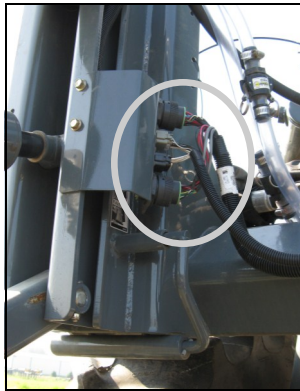

FIG 3.16-1

13. Disconnect the electrical connections at the right front of the machine. Disconnect the electrical pigtails at the right front of the machine. Check the pigtails for any damage such as broken connectors or loose wires.

Make sure that the harness is not left in a position that it could be damaged while the boom is not connected.



FIG 3.16-2

14. Disconnect the hydraulic connection on the left front of the machine. The hydraulics lines (fig. 3.16-2), equipped with quick couplers, do not have caps. Care must be taken when reconnecting the hoses to ensure that no foreign material enters the hydraulic system.

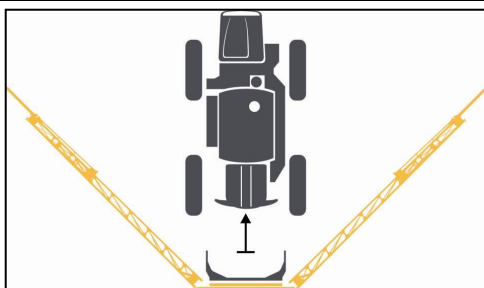

FIG 3.16-3

15. Slowly back the machine away from the boom attachment. Once all the connections have been disconnected, you may back away from the attachment.

III. OPERATING SYSTEMS

C. OPERATING INSTRUCTIONS

Quick attach: Connecting the boom

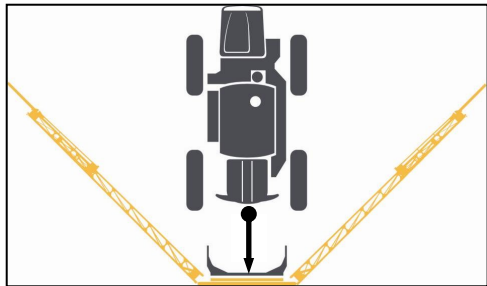

FIG 3.17-1

1. Pull squarely into the boom attachment. Slowly pull into the boom attachment until the quick attach hooks are in line above the quick attach pins.

The machine may be too high to fit under the quick attach hooks. In this case you need to release air from the air bags. If your machine is not equipped with relief valves you may order them from Hagie Customer Service.

NOTE: You may find it easier to use the speed control knob instead of the hydrostatic lever when trying to control your movement into the boom attachment.



FIG 3.17-2

2. Connect the hydraulic hoses on the left front of the machine.

Before connecting the hydraulic hoses, check to see that all openings on both the machine and the boom are clean. Pull the coupler's collar back to inspect for foreign material also.

The introduction of foreign material to the hydraulic system can cause filters and orifices to become plugged and disrupt oil flow.

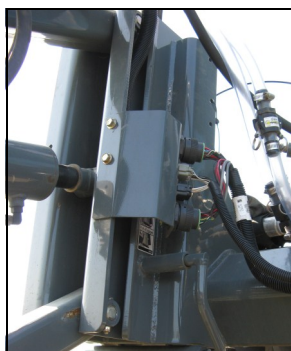

FIG 3.17-3

3. Connect the electrical pigtails on the right front of the machine. Inspect the pins, wires, and ports before connecting the electrical pigtails. Using an electrical connector that is damaged may result in erratic functions or a fire. Call Hagie Customer Service for replacement of damaged parts.

III. OPERATING SYSTEMS

C. OPERATING INSTRUCTIONS

Quick attach: Connecting the boom

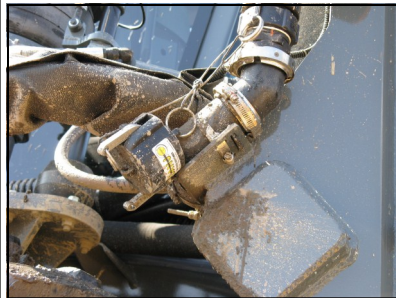

FIG 3.18-1

4. Connect the solution and foam marker hoses. Connect the solution hose (fig. 3.18-1) on the right side of the machine. Connect the foam marker hose (fig. 3.18-2, item A) and the rear nozzle hose (fig. 3.18-2, item B) at the front right of the machine.

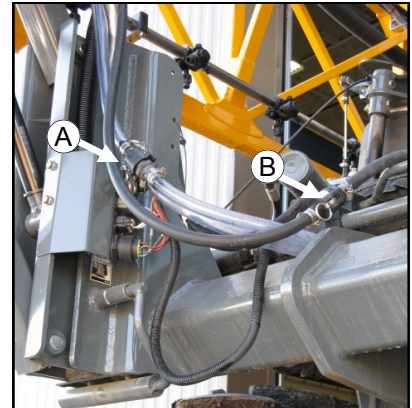

FIG 3.18-2



FIG 3.18-3

5. Open the quick attach lock assemblies. Make sure that the quick attach lock assemblies are open before you proceed with connecting the boom attachment. Pull the lock assembly out until it is fully extended and it stays open.



FIG 3.18-4

6. Turn ON the shut off valves on the level cylinders. Turn the valves so that they are parallel with the cylinder.

III. OPERATING SYSTEMS

C. OPERATING INSTRUCTIONS

Quick attach: Connecting the boom



	<p>7. Raise the transom so that the quick attach hooks engage the lock pins. Raise the transom only high enough that the hooks go over the pins. DO NOT raise the transom all the way up until you have checked to see that the quick attach lock assemblies are engaged fully.</p>	<p>CAUTION</p> <p>DO NOT OPERATE ATTACHMENTS WITHOUT FULL ENGAGEMENT OF QUICK ATTACH LOCK ASSEMBLY</p> <p>Disengaged</p> 
---	---	--

FIG 3.19-1

<p>8. Close the lock assemblies.</p> <p>9. Raise the RH and LH wing sections to level.</p>	<p>Fully Engaged</p>  <p>650178</p>
--	--

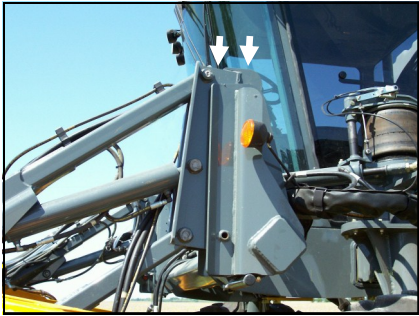

	<p>10. Raise the transom to allow the leg stands to be folded up. Remove the fastener from the lower hole and fold the leg up. Replace the fastener in the upper hole (fig. 3.19-2).</p>
---	---

FIG 3.19-2

<p>11. Retract the roll locks. Do not engage the Norac leveling functions until you have completed this step.</p>	 <p>FIG 3.19-3</p>
--	---

<p>12. Fold the boom either in or out to allow the position sensors to readjust. The horizontal fold will need to be activated in either direction to reset the position sensors and the main pivot breakaway.</p>	 <p>FIG 3.19-4</p>
---	---

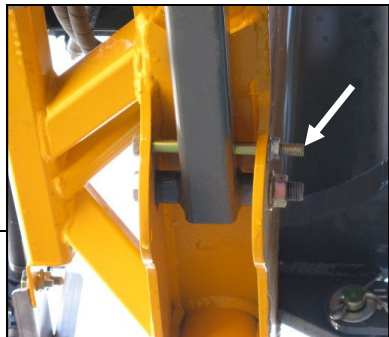
IV. CALIBRATION

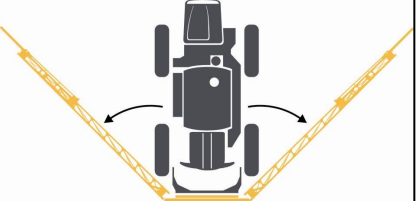
A. WET BOOM

Follow the instructions in the Hagie sprayer operator's manual to calibrate the wet boom. There are just a few things that are different in the set up: the boom lengths and the number of boom sections. The diagram shows how the 120ft boom is broke down into sections.

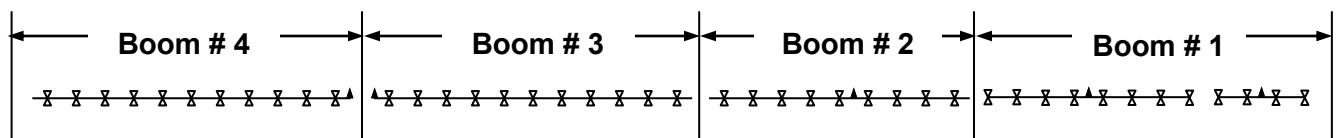
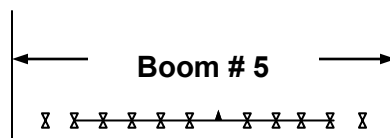
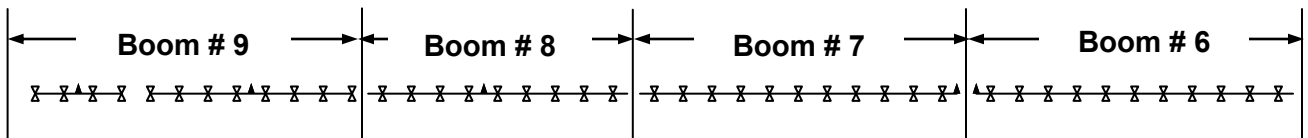
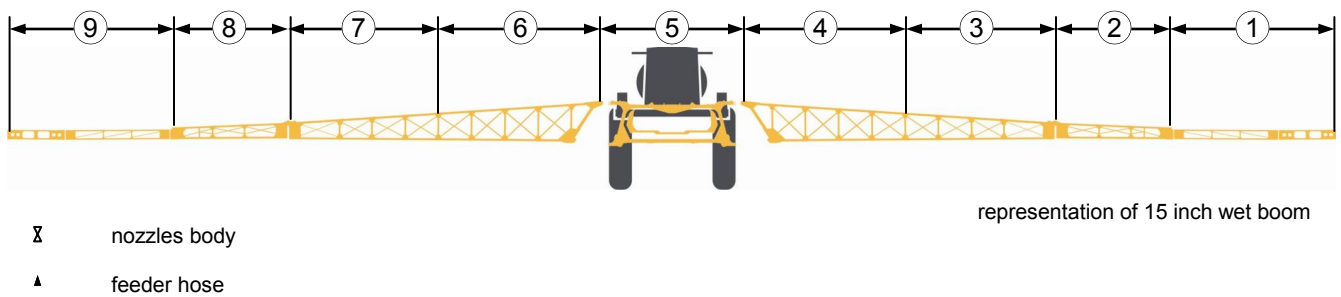

IV. CALIBRATION

D. NORAC CALIBRATION



From time to time it may be necessary to recalibrate or “re-tune” the hydraulic parameters of the Norac system. This will not calibrate the Norac sensors.

Read all operating material provided with this system. If you have any problems or questions, call Hagie Customer Service Department for assistance.

NOTE:

Stay clear of the Norac sensors when approaching the boom. Walking too close to the sensors may cause unexpected movement by the boom.

TO RE-TUNE:

1. Level the booms at normal working height. It is not necessary to have the booms 35 inches from the ground when performing a “retune”.
2. Toggle the AUTO (YES) switch to continue.
3. Hold the AUTO (YES) switch to begin sensor detect sequence. Continue to hold the switch until sequence is complete. If you let switch go, simply toggle and hold again to continue procedure.
4. The system will activate each section in both the up and down direction starting with the left side, right side, main (center), and finishing with the roll function. When the system is complete “done” will appear on the screen and you may release the switch.

IV. CALIBRATION

E. NORAC SENSOR CALIBRATION



Calibrating the Norac sensors is necessary to maintain an accurate working height. Detailed instructions can be found in the Norac operating manual.

If you continue to have problems with your system, contact Hagie Customer Service for assistance.

1. Unfold the booms into spray position. Make sure that the sensors are over bare soil or gravel— do not conduct this calibration over standing crop or tall grass or weeds.
2. Position the boom at normal working height.
3. Use a tape measure to measure the distance from the bottom of the spray nozzle closest to the sensor to the ground. Round to the nearest half inch.
4. On the console, get to the menu prompt “LOht” as described in the Norac manual.
5. If the height displayed is not the same as the measurement you just took, adjust it using the “+/-” switch.
6. Repeat steps 3 through 5 for each of the sensors on the boom.
7. Return to the normal operating screen by toggling the SETUP (NO) switch and holding it for two seconds.

V. TRANSPORTING

A. DRIVING



FIG 5.1-1

When driving the sprayer on a public roadway or highway, always have the booms cradled. For the purpose of driving on a roadway or elsewhere, be aware of any situations that the sprayer will be passing under an object. The design of the 120ft boom allows the transom to be lifted above the height of the cab, and remain higher than the cab when cradled (fig. 5.1-1, 5.1-2). Follow the procedure on the next page to lower the boom below the highest point of the cab.

 **WARNING**

NEVER operate the machine on a public roadway with solution in the tank!

 **WARNING**

DO NOT operate the machine at speeds exceeding 20mph with solution in the tank. Operating at speeds exceeding 20mph with a fully loaded tank may result in tire blow out or wheel hub damage and void the warranty.

 Hagie Manufacturing does not recommend any form of transportation other than driving the sprayer. Loading a sprayer onto a trailer may result in sprayer tip-over.



FIG 5.1-2

V. TRANSPORTING

B. TRAILERING



FIG 5.2-1

If the sprayer must be transported on a trailer, the transom will have to be lowered to below the maximum height (fig. 5.2-1). Follow these steps to lower the transom below the cab:

1. Raise the boom wings off their cradles.
2. Lower the transom to desired position.
3. Reposition the boom wings back into their cradles.

DO NOT leave the boom wings in their cradles when lowering the transom— damage will occur!



FIG 5.2-2

 Hagie Manufacturing does not recommend any form of transportation other than driving the sprayer. Loading a sprayer onto a trailer may result in sprayer tip-over.

VI. SERVICE AND MAINTENANCE

A. SERVICE POINT QUICK REFERENCE CHART

SERVICE POINT	CLEAN	CHANGE	CHECK	GREASE	DRAIN
Grease zerk for main pivot pin (1)				daily	
Grease zerks for rollers (6– 3 each side)				daily	
Norac sensor foam pads	daily	as req.			
Grease zerks 90/120ft breakaway fold (2-1 each side)				weekly	
Grease zerks level pivot tube (2-1 each side)				weekly	
Grease zerks main pivot tube (2-1 each side)				weekly	
Norac manifold hydraulic filter		yearly			
Friction pads		as req.	daily		

B. LUBRICATION





FIG 6.1-1

MAIN PIVOT PIN– The main pivot pin, located at the top center of the transoms, has a grease zerk located on the bottom side of the cross member. The zerk needs to be greased daily.



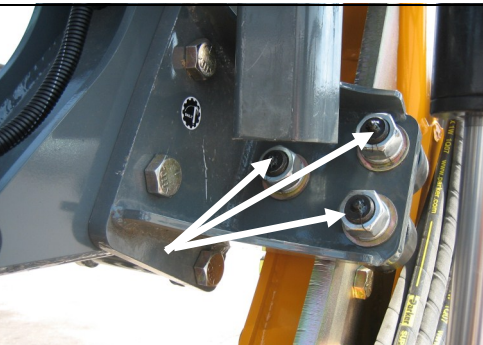



FIG 6.1-2

ROLLERS– Each roller has a zerk in the middle of the bolt that needs to be greased daily. Failure to keep the rollers properly lubed may result in roller seizure.



VI. SERVICE AND MAINTENANCE

B. LUBRICATION



FIG 6.2-1

LEVEL PIVOT TUBE– The level pivot tube has a grease zerk that need to be greased weekly. Failure to grease this zerk may result in reduced ability of the level functions.



FIG 6.2-2

90/120ft BREAKAWAY– The 90/120ft breakaway pivot needs to be greased weekly. Failure to grease this zerk may reduce the functionality of the breakaway.



FIG 6.2-3

MAIN PIVOT TUBE– The main pivot tubes on either side of the transom have a grease zerk that needs to be greased weekly. Failure to grease the main pivot tubes may result in difficulties when extending or retracting the horizontal fold.



VI. SERVICE AND MAINTENANCE

C. WEAR



FIG 6.3-1

FRICITION PADS– The friction pads located in the upper corners between the fixed transom and the rolling transom need to be checked daily. Check the pads for uneven wear and other damage. The pads must be replaced immediately if they are damaged. Failure to replace the pads may cause the boom to catch during roll functions and cause serious damage to the system.

D. FILTERS



FIG 6.3-2

NORAC SENSOR FOAM PADS– Inspect the foam insert of each sensor daily. Remove the foam from the sensor and blow it out with an air compressor and reinsert. Foam pads should be replaced as necessary. Replacement pads can be ordered through Hagie Customer Service Department

DO NOT blow the foam pad out while it is still on the sensor. To avoid damage, always remove the foam pad before cleaning. (693063- Hagie replacement part number for foam pad)



FIG 6.3-3

NORAC HYDRAULIC MANIFOLD FILTER– The hydraulic manifold filter needs to be changed at the end of every season to maintain peak performance by the Norac system.

To access the filter, remove the connection from the “P” port. Take every precaution to ensure that there is no contamination of the hydraulic system.

VII. STORAGE

A. PREPARING FOR STORAGE

1. Perform daily and weekly lubrication and maintenance inspections as required.
2. With the engine at normal operating temperature, cycle all hydraulic functions.
3. Thoroughly rinse the spray system. To winterize the spray system, it is recommended that you use an environmentally safe type antifreeze and water mixture that will give you adequate protection to -30°F . Drain any remaining solution in the spray system and run the antifreeze mixture through the system until it comes out all boom openings. Repeat the above process with the foam marker and rinse systems.
4. Refer to the Raven manual for detailed information on storage procedures for the monitor and flow meters.
5. Thoroughly wash the boom and touch up any chipped or scratched paint. For touch up paint recommendations contact the Hagie Customer Service Department.
6. Replace any damaged or missing decals. Warning decals and all other Hagie decals are available through the Hagie Customer Service Department.
7. Use multi-purpose grease to coat exposed hydraulic cylinder rods.
8. If the boom will be stored separately from the sprayer, be sure that all hose openings are capped or covered with a suitable covering.

B. REMOVING FROM STORAGE

1. Remove any dried grease from cylinder rods and reapply if necessary.
2. Completely clean the boom.
3. Carefully unseal any openings that were sealed in the storage process.
4. Attach to sprayer and manually cycle hydraulics 2 or 3 times to thoroughly lubricate components.
5. Test the NORAC system and all of its functions according to the NORAC manual.

VIII. TROUBLE SHOOTING

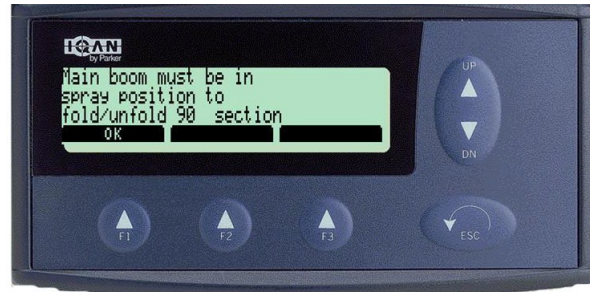
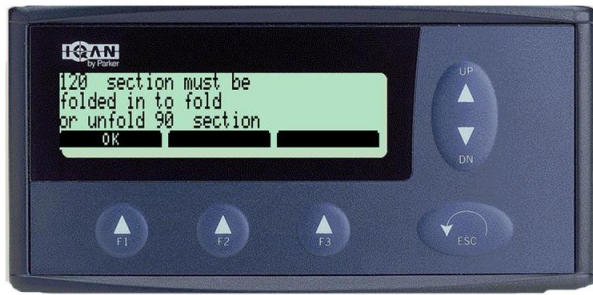

PROBLEM	POSSIBLE CAUSE	SUGGESTED REMEDY
The 90ft section will not fold or unfold	<ul style="list-style-type: none"> • The level cylinders are not above 6.75in. • Boom is not in spray position • The 120ft section is not completely folded in 	<ul style="list-style-type: none"> • Raise the level cylinders to above 6.75in. • The horizontal extension was not completed, MDM should read approx. 19.2in. for full extension • Activate the 120ft section switch to complete the fold process

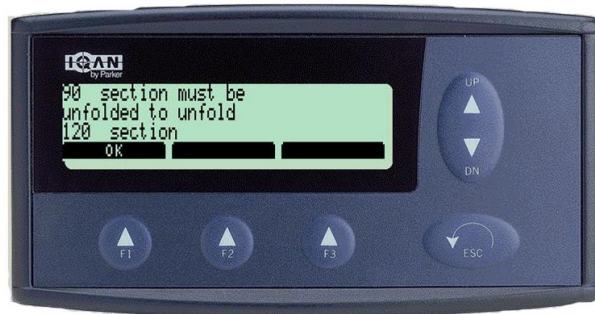

PROBLEM	POSSIBLE CAUSE	SUGGESTED REMEDY
The 120ft section will not fold or unfold	<ul style="list-style-type: none"> • The 90ft section is not unfolded 	<ul style="list-style-type: none"> • The 90ft section must be completely unfolded to allow the 120ft section to fold or unfold.

VIII. TROUBLE SHOOTING



PROBLEM	POSSIBLE CAUSE	SUGGESTED REMEDY
This message appears on the MDM	<ul style="list-style-type: none">• The boom shifted too far forward and is no longer in a safe position	<ul style="list-style-type: none">• Reset the booms by folding the booms in to approximately 12 inches according to the MDM and then folding the booms out until motion stops.

VIII. TROUBLE SHOOTING

NOTES

IX. LIMITED WARRANTY

Hagie Manufacturing Company Product Warranty

Hagie Manufacturing Company warrants each new Hagie (including Vammas by Hagie) product to be free under normal use and service from defects in workmanship and materials for a period of lesser of: two (2) years or 1000 hours from the date of delivery on all Agricultural Products and two (2) years or 2000 hours on all Vammas By Hagie Snow Removal Equipment (SRE). Hagie Manufacturing Company makes this warranty from the original delivery date and is transferable to a purchaser from the original purchaser of this equipment, given there is remaining time left under the year and hour warranty standard stated above. This warranty shall be fulfilled by repairing or replacing free of charge any part that shows evidence of defect or improper workmanship, provided the part is returned to Hagie Manufacturing Company within thirty (30) days of the date that such defect or improper workmanship is discovered, or should have been discovered. Labor to repair said items will be covered by standard labor time rates. Freight charges of defective parts are not covered by this warranty and are the responsibility of the purchaser. No other express warranty is given and no affirmation of Hagie Manufacturing Company, by words or action, shall constitute a warranty.

Hagie Manufacturing Company limits its warranty to only those products manufactured by Hagie Manufacturing Company (including Vammas by Hagie) and does not warrant any part or component not manufactured by Hagie Manufacturing Company (including Vammas by Hagie), such as parts or components being subject to their manufacturer's warranties, if any. Excluded from this warranty are parts subjected to accident, alteration, or negligent use or repair. This warranty does not cover normal maintenance such as engine tune ups, adjustments, inspections, nor any consumables such as tires, rubber products, solution system valves, wear parts, wiper blades, etc.

Hagie Manufacturing Company shall not be responsible for repairs or replacements which are necessitated, in whole or in part; by the use of parts not manufactured by or obtainable from Hagie Manufacturing Company nor for service performed by someone other than Hagie authorized personnel, unless authorized by Hagie Manufacturing Company. Customer acknowledges that it is not relying on Hagie Manufacturing Company's skill or judgment to select finish goods for any purpose and that there are no warranties which are not contained in this agreement.

In no event shall Hagie Manufacturing Company's tort, contract, or warranty liability exceed the purchase price of the product. The foregoing limitation will not apply to claims for personal injury caused solely by Hagie Manufacturing Company's negligence.

Hagie Manufacturing Company shall not be liable for damages, including special, incidental or consequential damages or injuries (damage and repairs of equipment itself, loss of profits, rental or substitute equipment, loss of good will, etc.) arising out of or in connection with performance of the equipment or its use by customer, and Hagie Manufacturing Company shall not be liable for any special, incidental or consequential damages arising out of or in connection with Hagie Manufacturing Company's failure to perform its obligation hereunder. HAGIE MANUFACTURING COMPANY'S ENTIRE LIABILITY AND THE CUSTOMER'S EXCLUSIVE REMEDY SHALL BE REPAIR OR REPLACEMENT OF PARTS COVERED UNDER THIS WARRANTY. THIS WARRANTY IN LIEU OF ALL OTHER WARRANTIES, EXPRESSED OR IMPLIED, INCLUDING, BUT NOT LIMITED TO THE IMPLIED WARRANTY OF MERCHANTABILITY OR FITNESS FOR A PARTICULAR PURPOSE.

INDEX

A		Main Pivot Pin 6.1	
Abbreviations i		Main Pivot Tube 6.2	
B		N	
Boom Solution Valve Switches 3.1		Norac Boom Leveling System 3.12	
Boom Widths 2.1		Norac Console 3.1	
Breakaway, 90/120ft 3.5		Calibration 4.2	
Service 6.2		Norac Hydraulic Manifold Filter 6.3	
Breakaway Locations 2.2		Norac Sensors 3.5	
C		Calibration 4.3	
Calibration 4.1-4.3		Foam pads 6.3	
Norac console 4.2		O	
Norac sensors 4.3		Operating Systems 3.1-3.19	
Wet boom 4.1		Boom 3.2-3.5	
Cradling 3.9-3.11		Breakaway, 90/120ft 3.5	
D		Fixed transom and lift arm 3.2	
Decals 1.7-1.9		Level cylinders 3.3	
E		Main pivot/breakaway cylinders 3.3	
Extension Switch, 120ft Boom 3.1		Norac sensors 3.5	
F		Pivot (rolling) transom 3.2	
Fixed Transom 3.2		Position sensors 3.4	
Filters 6.3		Proximity sensors 3.4	
Norac Hydraulic Manifold 6.3		Roll cylinders 3.4	
Foam Pads 6.3		Roll locks 3.3	
Friction Pads 6.3		Throttling valve 3.2	
G		Work Lights 3.5	
H		Cab controls 3.1	
I		Boom solution valve switches 3.1	
J		Norac console 3.1	
K		120ft boom extension switch 3.1	
L		Operating Instructions 3.6-3.19	
Level Cylinders 3.3		Cradling 3.9-3.11	
Level Pivot Tube 6.2		Norac boom leveling 3.12	
Lubrication 6.2		Quick attach 3.13-3.19	
M		Unfolding from cradles 3.6-3.8	
Main Pivot/Breakaway Cylinders 3.3		P	
N		Pivot (Rolling) Transom 3.2	
O		Position Sensors 3.4	
Operating Systems 3.1-3.19		Proximity Sensors 3.4	
Boom 3.2-3.5		Q	
Breakaway, 90/120ft 3.5		Quick Attach 3.13-3.19	
Fixed transom and lift arm 3.2		R	
Level cylinders 3.3		Re-Tune 4.2	
Main pivot/breakaway cylinders 3.3		Roll Cylinders 3.4	
Norac sensors 3.5		Roll Locks 3.3	
Pivot (rolling) transom 3.2		Rollers 6.1	
Position sensors 3.4		S	
Proximity sensors 3.4		Safety Precautions 1.1-1.3	
Roll cylinders 3.4		Service and Maintenance 6.1-6.3	
Roll locks 3.3		Filters 6.3	
Throttling valve 3.2		Lubrication 6.1-6.3	
Work Lights 3.5		Quick reference 6.1	
Cab controls 3.1		Specific Safety Issues 1.4-1.6	
Boom solution valve switches 3.1			
Norac console 3.1			
120ft boom extension switch 3.1			

INDEX

Specifications	2.1-2.3
Storage.....	7.1

T

Throttling Valve	3.2
Transporting	5.1-5.2
Trouble Shooting.....	8.1-8.3

U

Unfolding from cradles	3.6-3.8
------------------------------	---------

V

W

Warranty	9.1
Work Lights	3.5

X, Y, Z