



## TABLE OF CONTENTS

---

### 1 – INTRODUCTION

|   |      |
|---|------|
| A Word From Hagie Manufacturing Company ..... | 1-1  |
| About This Manual .....                       | 1-1  |
| Safety Messages Used In This Manual .....     | 1-2  |
| Service and Assistance .....                  | 1-2  |
| Identification .....                          | 1-2  |
| Specifications .....                          | 1-5  |
| 2014 Product Warranty .....                   | 1-14 |

### 2 – SAFETY AND PRECAUTIONS

|                          |     |
|--------------------------|-----|
| Safety Precautions ..... | 2-1 |
| Seat Belt .....          | 2-6 |
| Rotating Beacon .....    | 2-6 |
| Emergency Stop .....     | 2-6 |
| Emergency Exit .....     | 2-7 |
| Safety Decals .....      | 2-7 |

### 3 – CAB

|                                 |      |
|---------------------------------|------|
| Seat - Operator .....           | 3-1  |
| Seat - Operator (Premium) ..... | 3-2  |
| Seat - Instructor .....         | 3-3  |
| Operator's Station .....        | 3-3  |
| MD3 System .....                | 3-19 |

### 4 – ENGINE AND DRIVE SYSTEMS

|                             |     |
|-----------------------------|-----|
| Engine - Starting .....     | 4-1 |
| Hydrostatic Drive .....     | 4-2 |
| All-Wheel Steer (AWS) ..... | 4-5 |

### 5 – HYDRAULIC SYSTEMS

|                                   |     |
|-----------------------------------|-----|
| Hydraulic System Components ..... | 5-1 |
| Reversible Fan .....              | 5-4 |
| Tread Adjustment .....            | 5-5 |
| Ladder .....                      | 5-6 |
| Pressure Washer .....             | 5-7 |

### 6 – ELECTRICAL SYSTEMS

|                                  |     |
|----------------------------------|-----|
| Batteries .....                  | 6-1 |
| Battery Disconnect Switch .....  | 6-2 |
| Circuit Breakers And Fuses ..... | 6-3 |

### 7 – SPRAY SYSTEMS

|                                   |     |
|-----------------------------------|-----|
| Spray Booms - 60/80/90/100' ..... | 7-1 |
|-----------------------------------|-----|



|  |      |
|--|------|
| Spray Booms - 120/132' .....           | 7-7  |
| Spray Boom - Rear .....                | 7-18 |
| Solution System Components .....       | 7-19 |
| Solution System - Operation .....      | 7-23 |
| Filling Your Solution Tank .....       | 7-25 |
| Rinse System .....                     | 7-29 |
| Fence Row Applicator .....             | 7-31 |
| Foam Marker System .....               | 7-32 |
| Application .....                      | 7-34 |
| <b>8 – MAINTENANCE AND STORAGE</b>     |      |
| Service - Fluids .....                 | 8-1  |
| Service - Filters .....                | 8-5  |
| Service - Lubrication .....            | 8-9  |
| Service - Belts .....                  | 8-13 |
| Service - Bolt Torque .....            | 8-14 |
| Service - Toe-In .....                 | 8-16 |
| Service - Miscellaneous .....          | 8-18 |
| Service Intervals .....                | 8-23 |
| Storage .....                          | 8-27 |
| <b>9 – MISCELLANEOUS</b>               |      |
| Transporting .....                     | 9-1  |
| Lifting Points .....                   | 9-3  |
| Quick-Tach System - Spray Booms .....  | 9-4  |
| Air Suspension Exhaust .....           | 9-13 |
| Hand Wash System .....                 | 9-15 |
| Tall Corn Package - Installation ..... | 9-16 |
| Troubleshooting .....                  | 9-27 |



## SECTION 1 – INTRODUCTION

The following patent decal is located on the right-hand frame (behind the rear leg) and provides current patents issued on your machine.

*NOTE: Hagie Manufacturing Company reserves the right to make changes to any current patents or patents pending at any time, without notice.*



Hagie Manufacturing Patent Decal  
(Located on the right-hand frame behind rear leg)

### A WORD FROM HAGIE MANUFACTURING COMPANY

Congratulations on the purchase of your STS Sprayer! Read this operator’s manual and become familiar with operating procedures and safety precautions before attempting to operate your sprayer.

As with any piece of equipment, certain operating procedures, service, and maintenance are required to keep your machine in top running condition. We have attempted herein to cover all of the adjustments required to fit varying conditions. However, there may be times when special care must be considered.

*NOTE: The operator is responsible for inspecting the machine and it’s attachments, and having parts repaired or replaced when continued use of the product causes damage or excessive wear to other parts.*

Hagie Manufacturing Company reserves the right to make changes in the design and material of any subsequent sprayer without obligation to existing units.

Thank you for choosing a Hagie sprayer and we ensure you of our continued interest in its satisfactory operation for you. We are proud to have you as a customer!

### ABOUT THIS MANUAL

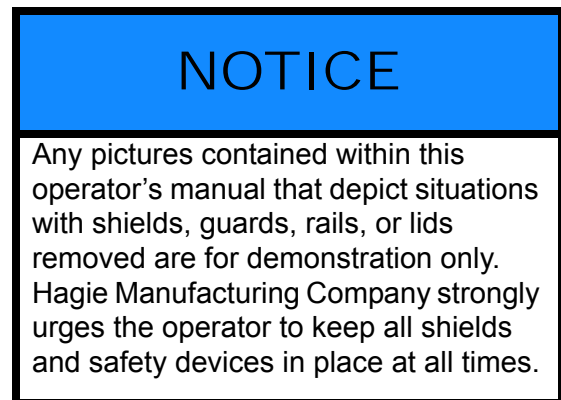

This manual will aid you in the proper operation and service of your machine. It is the responsibility of the user to read the operator’s manual and comply with the correct and safe operating procedures, as well as maintain the product according to the service information provided in the *Maintenance and Storage Section* elsewhere in this manual.

Photographs and illustrations used in this manual are of general nature only. Some of the equipment and features shown may not be available on your machine.

Information described in this manual was correct at the time of printing. Because of Hagie Manufacturing Company’s continuous product



improvement, certain information may not be included in this manual. To obtain the most current operator's manual for your machine, please visit [www.hagiehelp.com](http://www.hagiehelp.com).

Keep this manual in a convenient place for easy reference, should problems arise. This manual is considered a permanent fixture of the product. In the event of resale, this manual should accompany the machine.

If you do not understand any part of this manual or require additional information or service, contact Hagie Customer Support for assistance.

---

---

## SAFETY MESSAGES USED IN THIS MANUAL

The following safety messages found throughout this manual alert you of situations that could be potentially dangerous to the operator, service personnel, or equipment.

|  |
|--|
|  <b>DANGER</b>          |
| This symbol indicates a hazardous situation which, if not avoided, will result in serious injury or death. |

|   |
|---|
|  <b>WARNING</b>                      |
| This symbol indicates a potentially hazardous situation, which if not avoided, could result in serious injury or death. |

|   |
|---|
|  <b>CAUTION</b>  |
| This symbol indicates a potentially hazardous situation, which if not avoided, may result in minor or moderate injury. It may also be used to alert against unsafe practices. |

## NOTICE

This symbol indicates operator awareness, which if not avoided, may result in personal or property damage.

*NOTE: A "Note" is intended to make special mention of, or remark on.*

---

---

## SERVICE AND ASSISTANCE

For service and assistance, please contact:

**Hagie Manufacturing Company**  
**721 Central Avenue West**  
**P.O. Box 273**  
**Clarion, IA 50525-0273**  
**(515) 532-2861 OR (800) 247-4885**  
**[www.hagiehelp.com](http://www.hagiehelp.com)**

---

---

## IDENTIFICATION

## NOTICE

Reference to the right and left-hand used throughout this manual refers to the position when seated in the operator's seat facing forward.

Each machine is identified by means of a frame serial number. This serial number denotes the model, year in which it was built, and the number of the sprayer.

For further identification, the engine, hydrostatic pump, and attachments each have serial numbers, and the planetary hubs have identification plates that describe the type of mount and gear ratio.

To ensure prompt, efficient service when ordering parts or requesting service repairs, record the serial numbers and identification numbers in the following spaces provided.

## Sprayer

The sprayer serial number is stamped on the right-hand side of the frame (beneath the platform).

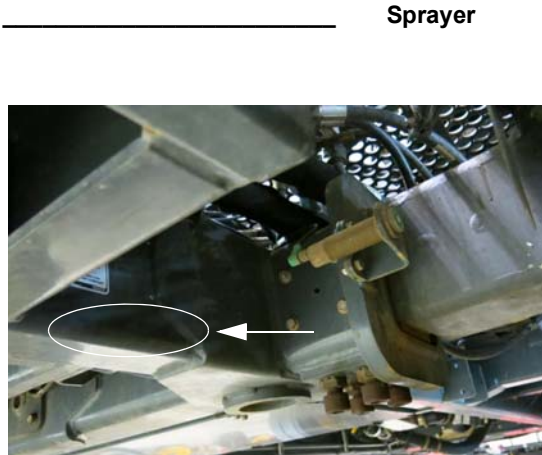

Sprayer Serial Number  
-Typical View

## Engine

The engine serial number is located on the engine block valve cover.



Engine Serial Number  
-Typical View

## Hydrostatic Pumps

The engine has Tandem Hydrostatic Pumps (located in front of the engine block). Refer to your Parts Manual for specific part number.



Tandem Hydrostatic Pumps  
-Typical View

\_\_\_\_\_ **Hydrostatic Pumps**

## Wheel Motors

The wheel motors each have an identification plate attached to it. The identification plate contains the serial number and other manufacturer information. Refer to your Parts Manual for specific part number.

- \_\_\_\_\_ **Right Front**
- \_\_\_\_\_ **Right Rear**
- \_\_\_\_\_ **Left Front**
- \_\_\_\_\_ **Left Rear**



Wheel Motor Identification Plate  
-Typical View

## Wheel Hubs

Each wheel hub has an identification plate attached to the front of the hub. The plate also contains information regarding gear ratio.

- \_\_\_\_\_ Right Front
- \_\_\_\_\_ Right Rear
- \_\_\_\_\_ Left Front
- \_\_\_\_\_ Left Rear



Wheel Hub Identification Plate  
-Typical View

## Aluminum Spray Booms (120/132')

The aluminum spray boom serial number is stamped on the lower right-hand side of fixed transom.

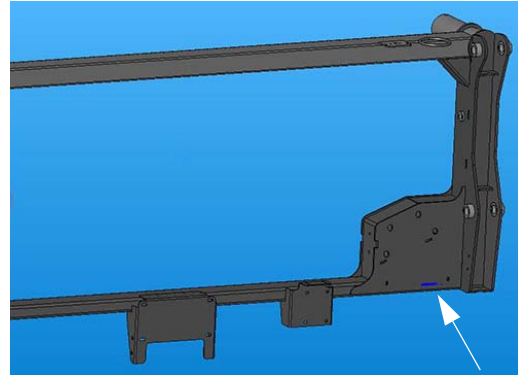

Aluminum Spray Boom Serial Number  
-Typical View

## Spray Boom

### Steel Spray Booms (90/100')

The steel spray boom serial number is stamped on the bottom right-hand side of transom.

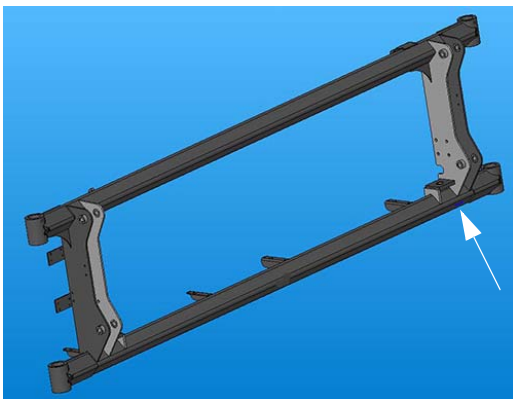

Steel Spray Boom Serial Number  
-Typical View

## SPECIFICATIONS

NOTE: 380/90 R54 tires used for the following machine dimensions.

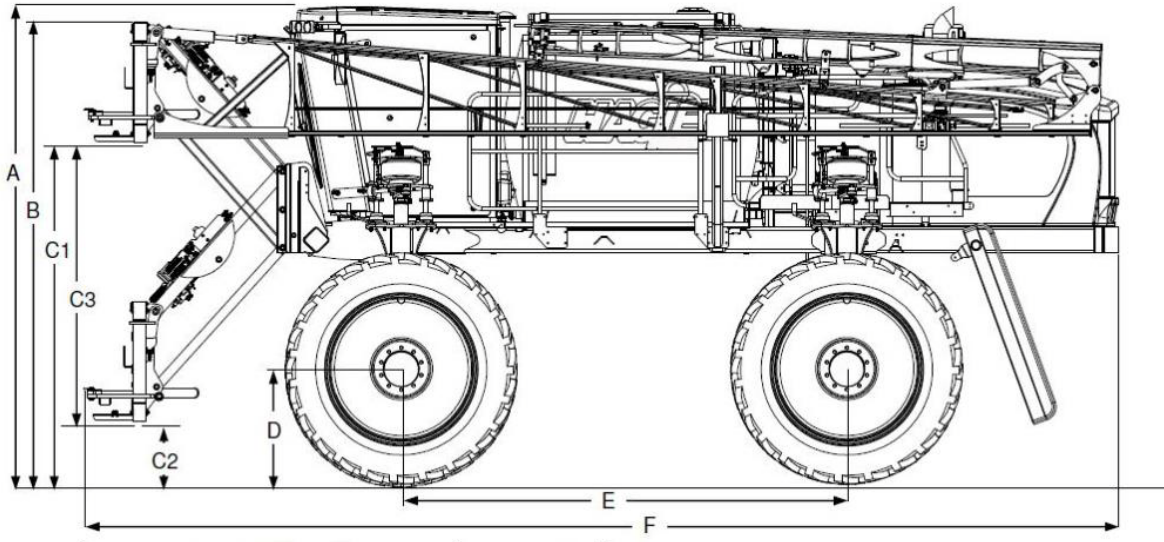

| Detail | Description  | Specification  |  |  |  |
|--------|--|--|--|--|--|
|        |  | 90-ft.<br>Boom   | 100-ft.<br>Boom  | 120-ft.<br>Boom  | 132-ft.<br>Boom  |
| A      | Overall Sprayer Height (from top of cab)<br><i>NOTE: Sprayer height dimension does not include the cab-mounted rotating beacon or the optional GPS unit.</i> | 155" **<br>(393.7 cm) **   | 155" **<br>(393.7 cm) **   | 155" **<br>(393.7 cm) **   | 155" **<br>(393.7 cm) **   |
| B      | Raised Transom Height  | 154" **<br>(391.2 cm) **<br>(from top of lights)                           | 154" **<br>(391.2 cm) **<br>(from top of lights)                           | 154" **<br>(391.2 cm) **<br>(from top of fixed transom)                    | 154" **<br>(391.2 cm) **<br>(from top of fixed transom)                    |
| C3     | Transom Lift Range (C1 minus C2)   | 86"<br>(104" - 18")<br>218.4 cm<br>(264.2-45.7 cm)                         | 86"<br>(104" - 18")<br>218.4 cm<br>(264.2-45.7 cm)                         | 86"<br>(104" - 18")<br>218.4 cm<br>(264.2-45.7 cm)                         | 86"<br>(104" - 18")<br>218.4 cm<br>(264.2-45.7 cm)                         |
| D      | Static Loaded Hub Height   | 38 3/8" **<br>(97.5 cm) **   | 38 3/8" **<br>(97.5 cm) **   | 38 3/8" **<br>(97.5 cm) **   | 38 3/8" **<br>(97.5 cm) **   |
| E      | Wheel Base   | 166" (421.6 cm)  | 166" (421.6 cm)  | 166" (421.6 cm)  | 166" (421.6 cm)  |
| F      | Sprayer Length   | 364" (924.6 cm)  | 364" (924.6 cm)  | 364" (924.6 cm)  | 364" (924.6 cm)  |
| G      | Width<br>(booms folded, 120"/304.8 cm tread)   | 144" (365.8 cm)  | 144" (365.8 cm)  | 177" (449.6 cm)  | 177" (449.6 cm)  |
| H      | Frame Clearance (to tread adjust bolts)  | 74" (188 cm) **  | 74" (188 cm) **  | 74" (188 cm) **  | 74" (188 cm) **  |
| I      | Lower Leg Clearance (from shield)  | 30" (76.2 cm) **   | 30" (76.2 cm) **   | 30" (76.2 cm) **   | 30" (76.2 cm) **   |
| J      | Tread Width*   | 122" - In **<br>(309.9 cm - In) **<br>154" - Out **<br>(391.2 cm - Out) ** | 122" - In **<br>(309.9 cm - In) **<br>154" - Out **<br>(391.2 cm - Out) ** | 122" - In **<br>(309.9 cm - In) **<br>154" - Out **<br>(391.2 cm - Out) ** | 122" - In **<br>(309.9 cm - In) **<br>154" - Out **<br>(391.2 cm - Out) ** |

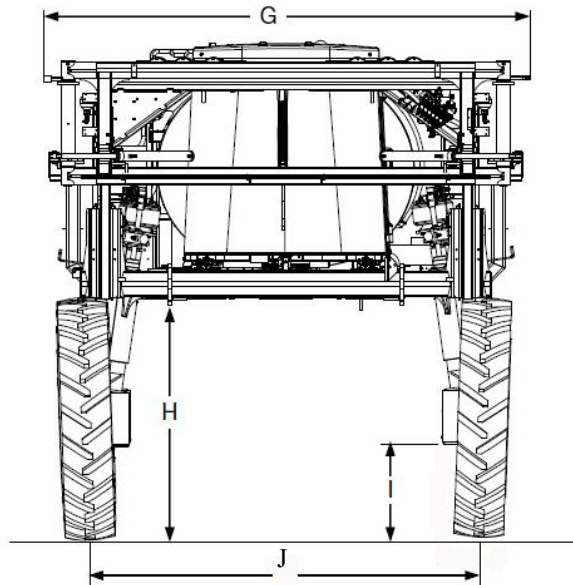

\* Tread width is measured at half (1/2) the tire height.

\*\* Refer to “Tire Specifications” for a complete listing of tire options when configuring machine specifications on your model.

## General Information

- **Frame Type:** 4 x 8” (10.2 x 20.3 cm) modular platform frame
- **Suspension:** 4-wheel, individual, auto air-ride
- **Approximate Dry Weight:**
  - \* 24,340 lbs./11,040 kg (machine only)
  - \* 28,840 lbs./13,081 kg (with 90’ boom)
  - \* 29,340 lbs./13,308 kg (with 100’ boom)
  - \* 30,240 lbs./13,716 kg (with 120’ boom)
  - \* 30,940 lbs./14,034 kg (with 132’ boom)
- **Shipping Width:**
  - \* 144”/365.8 cm (with 90/100’ boom)
  - \* 177”/449.6 cm (with 120/132’ boom)

## NOTICE

Because Hagie Manufacturing Company offers a variety of options, the illustrations in this manual may show a machine equipped other than standard. Height and weight do not consider options. Values may vary, depending on available equipment.



## Spray System GPS Specifications -If Equipped

*NOTE: 120-ft. boom and 380/90 R54 tires used for the following machine dimensions.*

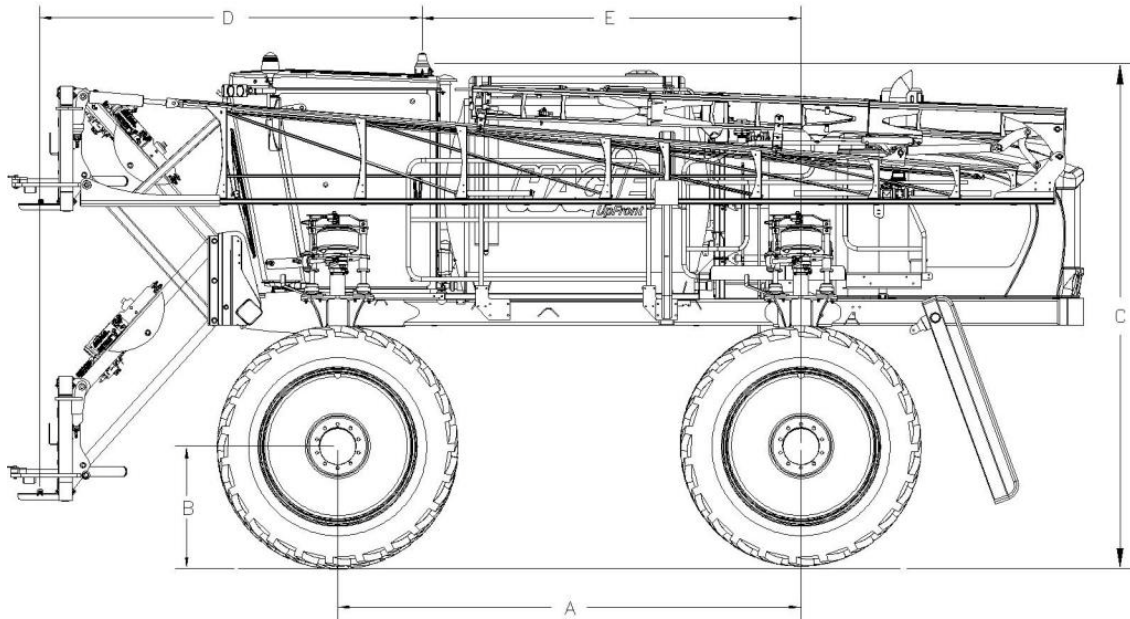

| Detail | Description   | Specification     |
|--------|---|-------------------|
| A      | Wheel Base  | 166" (421.6 cm)   |
| B      | Static Loaded Hub Height  | 38 3/8" (97.5 cm) |
| C      | Overall Sprayer Height (from middle of GPS unit)                | 157.4" (399.8 cm) |
| D      | Length<br>(from front of boom spray tips to center of GPS unit) | 130" (330.2 cm)   |
| E      | Length (from center of GPS unit to center of rear hub)          | 141" (358.1 cm)   |

*NOTE: Dimensions may vary depending on boom and tire options.*



### Settings and Calibration

Record settings and calibration values used in the following spaces provided when programming your spray system console. Refer to this information for future reference.

Circle the selected setting on the spray system console for the following options:

|                     |                     |                                  |   |  |   |
|---------------------|---------------------|----------------------------------|---|--|---|
| <b>Units</b>        | • US (Acres)        |                                  | • SI (Hectares)                                   |  | • Turf<br>(1,000 sq. ft./<br>92 sq. m)    |
| <b>Speed Sensor</b> | • SP1 (Wheel Speed) |                                  | • SP2 (Radar/GPS)                                 |  |   |
| <b>Control Type</b> | • Liquid Spray      | • Gran 1<br>(Single Belt<br>Bed) | • Gran 2<br>(Split Belt<br>Bed/Single<br>Encoder) | • Gran 3<br>(Split Belt<br>Bed/Dual<br>Encoders) | • Spinner RPM<br>Control                  |
| <b>Valve Type</b>   | • Standard<br>Valve | • Fast Valve                     | • Fast Close<br>Valve                             | • Pulse Width<br>Modulated<br>Valve              | • Pulse Width<br>Modulated<br>Close Valve |

Record calculated calibration values in the spaces provided below.

| Speed Cal | Section Widths | Meter Cal | Rate Cal | Valve Cal | Tank Volume |
|-----------|----------------|-----------|----------|-----------|-------------|
| 1.        | 1.             | 1.        | 1.       | 1.        | 1.          |
|           | 2.             | 2.        | 2.       | 2.        | 2.          |
|           | 3.             | 3.        | 3.       | 3.        | 3.          |
|           | 4.             | 4.        | 4.       | 4.        | 4.          |
|           | 5.             | 5.        | 5.       | 5.        | 5.          |
|           | 6.             |           |          |           |             |
|           | 7.             |           |          |           |             |
|           | 8.             |           |          |           |             |
|           | 9.             |           |          |           |             |
|           | 10.            |           |          |           |             |

| Item  | Specification   |
|---|---|
| <b>Engine</b>                                       |   |
| <b>Manufacturer</b>                                 | Cummins®  |
| <b>Model</b>  | QSL 8.9   |
| <b>Type</b>   | Electronic with air-to-air cooler and turbo charger   |
| <b>Number of Cylinders</b>                          | 6   |
| <b>Displacement</b>                                 | 8.9 liters (543 c.i.)   |
| <b>Horse Power</b>                                  | 365 hp (272 KW)   |
| <b>Type of Fuel</b>                                 | No. 1 or No. 2 Diesel   |
| <b>Fuel System</b>                                  | Filtered, direct-injected   |
| <b>Air Cleaner</b>                                  | Dry-type, dual element  |
| <b>Engine Air Filter Restriction Monitors</b>       | Filter Minder®  |
| <b>Slow Idle</b>                                    | 850 RPM   |
| <b>Fast Idle (no load)</b>                          | <ul style="list-style-type: none"> <li>• 2100 (Road Mode)</li> <li>• 2500 (Field Mode)</li> </ul> |
| <b>Hydrostatic Drive</b>                            |   |
| <b>Hydrostatic Pump</b>                             | Sauer-Danfoss Tandem H1-Series  |
| <b>Drive Train</b>                                  | All-Wheel 4-Wheel Drive   |
| <b>Speed Ranges<sup>^</sup></b>                     | 4 in field state, 7 in road state   |
| <b>Hydrostatic Wheel Motors</b>                     | Sauer-Danfoss   |
| <b>Final Drives</b>                                 | Planetary gear reduction hubs   |
| • Lubrication                                       | Oil bath  |
| <b>Brakes (Parking Only)</b>                        | Multiple disk, spring applied, hydraulically released   |
| <b>Steering System</b>                              | Hydraulic, dedicated circuit  |
| • Control   | Full-time power   |
| • Steering Cylinders                                | Self-centering, double action   |
| • Turning Radius <sup>^</sup>                       | 22.5 ft. (685.8 cm)   |
| <b>All Wheel Steer (AWS) - optional<sup>^</sup></b> | Coordinated steering  |
| <b>Auxiliary Hydraulic System</b>                   |   |
| <b>Type</b>   | Single closed center pump   |
| <b>Pump Type</b>                                    | Load sense  |



| Spray System  |   |
|---|---|
| <b>Booms</b>  | 60/80/90/100-ft. (9 sections), 120/132-ft. (optional)                     |
| • Type  | Dry with variable row spacing (wet optional)                              |
| • Controls  | Electro-hydraulic (fold/lift/level)                                       |
| • Level Shock Absorber                                      | Gas charged accumulator   |
| • 80/90/100-ft. Outer Boom Hydraulic Breakaway              | Self-actuated, auto-reset hydraulic                                       |
| • 120/132-ft. Inner Boom Breakaway                          | Hydraulic, manual reset   |
| • 120/132-ft. Outer Boom Breakaway                          | Mechanical with spring, auto-reset  |
| <b>Solution Fill Connection</b>                             |   |
| • Quick-fill Connection                                     | 3" (7.6 cm) inner diameter  |
| <b>Solution Tank</b>  |   |
| • Standard  | 1600 gal. (6056 L), stainless steel                                       |
| <b>Agitation</b>  |   |
| • Stainless Steel Tank                                      | Sparge-type with electric variable speed control                          |
| <b>General Spray System</b>                                 |   |
| • Pump  | Centrifugal-hydraulically driven with pulse width modulated control valve |
| • Solution Valves   | Electric ball valves  |
| • Pressure Gauge  | 100 PSI (6.9 bar) glycerin filled   |
| • Console   | Raven 5000 (GPS ready)  |
| • Fence Row Nozzle  | 2-position, remote activated  |
| • Rear Nozzle   | 2-position, remote activated  |
| Foam Marking System   |   |
| <b>Make</b>   | Richway   |
| <b>Type</b>   | Boom Mix  |
| Rinse System  |   |
| <b>Spray System Rinse (solution tanks, pump, and booms)</b> | Standard  |
| <b>High-Pressure Washing System</b>                         | Optional  |
| Electrical System   |   |
| <b>General Electrical System</b>                            |   |
| • Battery   | Dual 12V, negative ground   |
| • Alternator  | 200 AMP, voltage regulated  |



|  |                   |
|--|-------------------|
| • Starter  | 12V with solenoid |
| <b>Circuit Breakers/Fuses</b>  |                   |
| 1. Fuse Module 1 (used in mini-lighted fuses)  |                   |
| • MD3 Monitor  | 3 AMP (1)         |
| • Console Lights, Field Lights, Work Lights, Console Switch Power, Control Handle  | 5 AMP (4)         |
| • Road Lights, Ignition, Hazard Lights, Horn, Seat Air Pump, Radio Power   | 10 AMP (3)        |
| • Power Port 1, HVAC Control, Wiper/Washer, Switch Power-to-Power Connectors (1, 2, 3), Switch Power-to-Power Point 2, Boom Lights   | 15 AMP (6)        |
| • Battery Power-to-Power Connectors (1, 2, 3), Raven Monitor, Cab Module 1 (XS2-A0), Cab Module 2 (XS2-A1), Boom Spray Valve 1   | 20 AMP (5)        |
| • HVAC Fan-High  | 25 AMP (1)        |
| 2. Fuse Module 2 (used in mini-lighted fuses)  |                   |
| • Ignition ON, Radio Memory, RTC Battery   | 5 AMP (2)         |
| • Diagnostic Plug, Solution Pump Valve   | 10 AMP (2)        |
| • Field Lights Relays (1, 2, 3), Boom Spray Valve 2, Norac (if equipped), Switch Power-to-Power Connectors (4, 5, 6)   | 15 AMP (7)        |
| • Battery Power to Connectors (4, 5, 6), Chassis Module 1 (XA2-A0), Chassis Module 2 (XA2-A1), Cab 1 Module (XS2-A0), Cab 2 Module (XS2-A1), 90-ft. Boom Implement Module 1 (XA2-A3), 90-ft. Boom Implement Module 2 (XS2-A4), 120-ft. Boom Implement Module 1 (XA2-A3), 120-ft. Boom Implement Module 2 (XS2-A4), 120-ft. Boom Implement Module 3 (XA2-A4), NTB (if equipped) Implement Module 4 (XA2-A3) | 20 AMP (8)        |
| 3. Relay Module 1  |                   |
| • Ignition ON, Start Interlock, Fan High, Start Switch Signal, Start Relay Control Signal, High Fan Relay Output, High Fan Relay Control Signal, Field Lights Relay Out, RM1 Ground Wire, Relay Control Jumper, Console Light, Blank (1)   | 12V Micro relays  |
| 4. Relay Module 2  |                   |
| • Auto Steer Relay, Field Lights 1 and 2 Relays, Blank (3)   | 12V Micro relays  |
| <b>Engine Electrical Box</b>   |                   |

SECTION 1 –  
INTRODUCTION



|                                 |   |
|---------------------------------|---|
| 1. Fuses                        | <ul style="list-style-type: none"> <li>• 15 AMP (3), 20AMP (1), 30 AMP (1) - used ATO/ATC lighted fuses</li> <li>• 125 AMP (2) - used AMG type fuses</li> </ul> |
| 2. Relays                       |   |
| • Start, Auxiliary              | 12V/40 AMP (2)  |
| • Intake Heater 1 and 2         | 12V micro (2)   |
| 3. Circuit Breaker              |   |
| • Main Breaker                  | 120 AMP (1)   |
| <b>Other Fuses and Relays</b>   |   |
| 1. Auxiliary Fuse/Relay Module  | 15 AMP fuse (6), 20 AMP fuse (2), 12V 35A micro relay (6) - used mini lighted fuses   |
| 2. 90-ft. Boom Harness          | 30 AMP fuse   |
| <b>Lights</b>                   |   |
| 1. Front of Cab                 | 2 trapezoidal headlights, 4 floodlights, rotating amber beacon light  |
| 2. Transom                      | 2 trapezoidal headlights  |
| 3. Transom Mount                | 2 trapezoidal headlights, 2 oval amber lights   |
| 4. Boom Cradle (forward facing) | 2 trapezoidal floodlights (1 on each cradle)  |
| 5. Boom Cradle (rear facing)    | 2 trapezoidal floodlights (1 on each cradle); 2 oval amber lights (1 on each cradle)  |
| 6. Rear Engine Hood             | 2 round red lights, 2 round amber lights  |
| 7. Transom (boom indicators)    | 1 oval white LED, 2 oval amber LEDs, 9 oval red LED (12, if equipped with 120/132-ft. boom)   |
| <b>Cab and Instruments</b>      |   |
| <b>Cab (General)</b>            | Tilt steering, wipers/washers, dual side mirrors, dome light, tinted glass, instructor seat   |
| <b>Temperature Control</b>      | Full range  |
| <b>A/C Charge Type</b>          | R-134a  |
| <b>Fresh Air Filtration</b>     | Paper and charcoal filter   |
| <b>Seat</b>                     | Air ride  |
| <b>Instruments</b>              |   |
| <b>MD3 Monitor</b>              | Hour meter, fuel, water temperature, battery voltage, engine oil pressure, ground speed, engine RPM, tread adjust assist  |
| <b>Stereo</b>                   | AM/FM/WB with CD  |



| Capacities   |                         |
|--|-------------------------|
| <b>Solution Tank</b>   | 1600 gallons (6065 L)   |
| <b>Fuel Tank</b>   | 175 gallons (662 L)     |
| <b>Cooling System<br/>(including block, lines, and radiator)</b>       | 12 gallons (68 L)       |
| <b>Hydraulic Oil (including tank, filter, and cooler)</b>              | 65 gallons (246 L)      |
| <b>Rinse System Tank</b>   | 100 gallons (379 L)     |
| <b>Foam Marker</b>   | 36 gallons (136 L)      |
| <b>Engine Oil<br/>(including crankcase, lines, filter, and cooler)</b> | 25 quarts (23 L)        |
| <b>Wheel Hubs (front and rear)</b>                                     | 40 ounces (1.18 L)/each |

- ^ Operators with machines equipped with All-Wheel Steer (AWS) pay special attention.
- Filter Minder is a registered trademark of Engineered Products Company.

| TIRE SPECIFICATIONS (STANDARD) |            |             |                        |                      |                        |                           |                               |                          |
|--------------------------------|------------|-------------|------------------------|----------------------|------------------------|---------------------------|-------------------------------|--------------------------|
|                                | Make       | Load Rating | Air Pressure (Max PSI) | Tread Width (inches) | Load Capacity (lbs.) * | Overall Diameter (inches) | Static Load Radius** (inches) | Rolling Circum. (inches) |
| <b>380/90 R46</b>              | Michelin®  | 173D        | 64                     | 15.1                 | 14,330                 | 72.5                      | 33.4                          | 217.7                    |
| <b>380/105 R50</b>             | Firestone® | 177D        | 70                     | 15.9                 | 16,100                 | 80.7                      | 37.3                          | 244                      |

- \* Load capacity measured at 30 mph unless otherwise specified.
- \*\* Static load radius is suggested and will vary with load.

| TIRE SPECIFICATIONS (METRIC) |            |             |                        |                  |                      |                       |                           |                      |
|------------------------------|------------|-------------|------------------------|------------------|----------------------|-----------------------|---------------------------|----------------------|
|                              | Make       | Load Rating | Air Pressure (Max Bar) | Tread Width (cm) | Load Capacity (kg) * | Overall Diameter (cm) | Static Load Radius** (cm) | Rolling Circum. (cm) |
| <b>380/90 R46</b>            | Michelin®  | 173D        | 4.4                    | 38.4             | 6,500                | 184.2                 | 84.8                      | 553                  |
| <b>380/105 R50</b>           | Firestone® | 177D        | 4.8                    | 40.4             | 7,302                | 205                   | 94.7                      | 619.8                |

- \* Load capacity measured at 48.28 km/h unless otherwise specified.
- \*\* Static load radius is suggested and will vary with load.



---

---

## 2014 PRODUCT WARRANTY

### **Hagie Manufacturing Company Product Warranty**

Hagie Manufacturing Company warrants each new Hagie product to be free under normal use and service from defects in workmanship and materials for a period of lesser of: two (2) years or 1000 hours from the date of delivery on all Agricultural Products. Hagie Manufacturing Company makes this warranty from the original delivery date and is transferable to a purchaser from the original purchaser of this equipment, given there is remaining time left under the year and hour warranty standard stated above. This warranty shall be fulfilled by repairing or replacing free of charge any part that shows evidence of defect or improper workmanship, provided the part is returned to Hagie Manufacturing Company within thirty (30) days of the date that such defect or improper workmanship is discovered, or should have been discovered. Labor to repair said items will be covered by standard labor time rates. Freight charges of defective parts are not covered by this warranty and are the responsibility of the purchaser. No other express warranty is given and no affirmation of Hagie Manufacturing Company, by words or action, shall constitute a warranty.

Hagie Manufacturing Company limits its warranty to only those products manufactured by Hagie Manufacturing Company and does not warrant any part or component not manufactured by Hagie Manufacturing Company, such as parts or components being subject to their manufacturer's warranties, if any. Excluded from this warranty are parts subjected to accident, alteration, or negligent use or repair. This warranty does not cover normal maintenance such as engine tune ups, adjustments, inspections, nor any consumables such as tires, rubber products, solution system valves, wear parts, wiper blades, etc.

Hagie Manufacturing Company shall not be responsible for repairs or replacements which are necessitated, in whole or in part; by the use of parts not manufactured by or obtainable from Hagie Manufacturing Company nor for service performed by someone other than Hagie authorized personnel, unless authorized by Hagie Manufacturing Company. Customer acknowledges that it is not relying on Hagie Manufacturing Company's skill or judgment to select finish goods for any purpose and that there are no warranties which are not contained in this agreement.

In no event shall Hagie Manufacturing Company's tort, contract, or warranty liability exceed the purchase price of the product. The foregoing limitation will not apply to claims for personal injury caused solely by Hagie Manufacturing Company's negligence.

Hagie Manufacturing Company shall not be liable for damages, including special, incidental or consequential damages or injuries (damage and repairs of equipment itself, loss of profits, rental or substitute equipment, loss of good will, etc.) arising out of or in connection with performance of the equipment or its use by customer, and Hagie Manufacturing Company shall not be liable for any special, incidental or consequential damages arising out of or in connection with Hagie Manufacturing Company's failure to perform its obligation hereunder. HAGIE MANUFACTURING COMPANY'S ENTIRE LIABILITY AND THE CUSTOMER'S EXCLUSIVE REMEDY SHALL BE REPAIR OR REPLACEMENT OF PARTS COVERED UNDER THIS WARRANTY. THIS WARRANTY IN LIEU OF ALL OTHER WARRANTIES, EXPRESSED OR IMPLIED, INCLUDING, BUT NOT LIMITED TO THE IMPLIED WARRANTY OF MERCHANTABILITY OR FITNESS FOR A PARTICULAR PURPOSE.



## SECTION 2 – SAFETY AND PRECAUTIONS

---

Most accidents occur as the result of failure to follow basic and fundamental safety rules and precautions. Recognizing potential safety hazards, following correct and safe operating procedures described in this manual, and complying with safety warnings located throughout the machine may reduce the risk of accidents.

There is no way to completely eliminate the potential for danger when operating agricultural equipment. Therefore, you must study this operator's manual and understand how to operate the sprayer controls for safe operation before using the sprayer, its attachment, or any sprayer equipment. Likewise, never let anyone operate the machine without proper instruction.

Do not operate the sprayer, its attachment, or any sprayer equipment for anything other than their intended uses. Hagie Manufacturing Company shall not be liable for any damage, injury, or death associated with improper use of the sprayer, its attachment, or any sprayer equipment.

Do not make any modifications such as weldments, add-ons, adaptations, or changes from the original design of the sprayer. Such modifications may become safety hazards to you and others and **will void all warranties**.

Replace missing, faded, or damaged safety signs. Refer to "Safety Decals" elsewhere in this section for correct sign and placement.

---

---

### SAFETY PRECAUTIONS

*NOTE: If your machine is equipped with All Wheel Steer (AWS), pay special attention to instructions, components, and safety warnings marked with ^.*

#### Do Not Bypass Safety Start Switch

- Start the machine from the operator's seat only.
- The parking brake must be engaged before starting the engine.



#### Use Caution While Driving ^

- Never drive near ditches, embankments, holes, mounds, or other obstacles.
- Never drive on hills too steep for safe operation.



- Reduce the sprayer speed while turning.



- Do not permit passengers to ride on machine while it is moving. Failure to comply may result in passenger falling off of machine and/or obstructing the operator's view.



- Check overhead clearance before driving under any overhead obstructions. Contact with power lines may result in serious injury or death.



- Booms must be folded and in cradles when driving.

## Keep Riders Off Machine

- Do not permit passengers to ride on the machine or in the cab. The only time passengers should be permitted is for instructional or diagnostic purposes only. The passenger should be seated in the Instructor Seat next to the operator and never allowed to ride outside of the cab.

## Remove Paint Before Welding or Heating

- Avoid toxic fumes and dust. Hazardous fumes can be generated when paint is heated by welding, soldering, or using a torch.



- Do not use chlorinated solvents in areas where welding will take place.
- Perform all work in an area that is well ventilated to carry toxic fumes and dust away.
- Dispose of paint and solvents properly.

## Avoid Heating Near Pressurized Lines

- Avoid torching, welding, and soldering near pressurized hydraulic lines. Pressurized lines may accidentally burst when heat goes beyond the immediate flame area.



## Handle Fuel Safely

- Always turn engine off and allow it to cool before refueling.

- NEVER smoke while refueling.



- Do not fill tank completely, as fuel may expand and run over.
- Always clean up spilled fuel with soapy water.
- Keep a fire extinguisher nearby when refueling.



## Operate Safely ^

- Before moving the sprayer, ensure there are no obstacles or persons in the path of travel.
- Never operate a machine in the same field as walking personnel.
- Always drive at a reasonable field speed.
- Never operate the sprayer on roadway with solution in the tank. Additional weight caused from partially full or full solution tanks may cause erratic or increased stopping distance.
- Do not operate the machine at speeds exceeding 20 mph (32 km/h) with solution in the tank. Operating speeds exceeding 20 mph (32 km/h) with a fully loaded tank may result in tire blow-out or wheel hub damage and will void the warranty.
- Ensure Slow Moving Vehicle (SMV) and SIS emblem is in place and visible from the rear when traveling on public roadways.



- Pull over to the side of the road before stopping.
- Always come to a complete stop before reversing directions.
- Keep a fire extinguisher nearby at all times.
- Keep ALL shields in place.
- Keep clear of all moving parts and keep others away when operating.
- Do not wear loose fitting clothing that may be blown or drawn into moving parts.
- Do not activate the parking brake while the machine is in motion.
- Bring machine to a slow stop to avoid sudden downward decent.
- Reduce speed for icy, wet, graveled, or soft roadway surfaces.
- Use flashers/hazard warning lights (day or night) unless prohibited by law.
- Keep away from overhead power lines. Serious injury or death may result to you or others should the machine contact electrical power lines.
- Never fold/unfold boom extension while the main boom is in the cradle.
- Never operate sprayer with one boom out of the cradle, and the other boom in the cradle.
- Do not adjust factory engine RPM settings.
- Never use starting fluid to assist engine start-up.
- If your machine is equipped with ground speed sensing radar or light sensing depth units, do NOT look directly into radar beam, as it emits a very low intensity microwave signal, which may result in possible eye damage.

## Be Prepared

- Be prepared for an emergency. Keep a fire extinguisher, first aid kit, and clean water in the cab.
- Service the fire extinguisher regularly. Keep an accurate inventory of supplies in the first aid kit and dispose of anything that has expired.

## Wear Protective Clothing

- Do not wear loose fitting clothing that could get caught in moving parts. Wear safety equipment that is appropriate for the job.



- Do not store chemical-soaked clothes in the cab. Clean off as much mud and dirt from your shoes as you can before entering the cab.

## Protect Against Noise

- Operating equipment safely requires the full attention of the operator. Do not wear radio or music headphones while operating the machine.
- Prolonged exposure to loud noise may result in loss of hearing. Wear suitable hearing protection.



## Battery Acid Accident Prevention

Avoid serious injury by avoiding battery acid contact with your body. Battery electrolyte contains sulfuric acid that is strong enough to eat holes in clothing and cause blindness if splashed into eyes.

### Make sure to:

- Fill batteries in a well ventilated area.
- Wear Personal Protective Equipment (PPE) when servicing a battery.
- Avoid breathing in the fumes when recharging with electrolyte.
- Avoid spilling or dripping electrolyte.
- When charging a battery, connect positive cable to positive terminal and negative cable to negative terminal. Failure to comply may result in an explosion and/or personal injury.

### If you spill on yourself:

- Flush affected area with cold water and remove contaminated clothes and shoes immediately. Continue to flush the area for a minimum of 15 minutes.



- Call a physician.
- While transporting or waiting for medical attention, apply compresses of iced water or immerse affected area in iced water. **DO NOT ALLOW TISSUE TO FREEZE.**
- Do not apply creams or ointments until you have been seen by a physician.

### If acid is swallowed:

- Do NOT induce vomiting.
- Drink large amounts of water.
- Seek medical attention immediately!
- Do not neutralize the acid.

### If fumes are inhaled:

- Move the person into fresh air.
- Do not give artificial respiration to a person that is able to breath on their own.
- Give CPR only if there is no breathing and no pulse.
- Seek medical attention immediately!

## Handle Agricultural Chemicals Safely

Agricultural chemicals used in applications can be harmful to your health and the environment if not used carefully.

- Always follow the manufacturer's label for directions of use.
- Never allow chemicals to come in contact with your skin or eyes. Always use the proper Personal Protective Equipment (PPE).
- NEVER pour chemicals into an empty tank. Always fill tank half full of water first.
- Dispose of empty chemical containers properly.



- Wash spilled chemicals or spray residue from the sprayer to prevent corrosion and deterioration.
- Select safe areas to fill, flush, calibrate, and clean sprayer where chemicals will not run off to contaminate people, animals, vegetation, or water supply.
- Never place a spray nozzle to your lips in an attempt to unclog it.
- Do not spray when wind is in excess of chemical manufacturer's recommendation.
- Store chemicals in their original containers with the label intact.
- Store chemicals in a separate, locked building.
- Wear Personal Protective Equipment (PPE) as recommended by the chemical manufacturer.

## Safe Hydraulic Maintenance

- Always practice personal safety when performing service or maintenance on the hydraulic system.
- Use caution when working around hydraulic fluid under pressure. Escaping fluid can have sufficient force to penetrate your skin, possibly resulting in serious injury. This fluid may also be hot enough to burn.

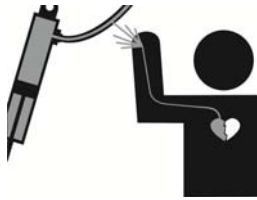

- Always lower the load or relieve the pressure before repairing a hydraulic oil leak.

## Beware of Exhaust Fumes

- Never run the machine in a closed building. Proper ventilation is required. Use an exhaust pipe extension to remove fumes if you must operate in a building. Also, open doors and windows to bring in enough outside air into the area.

## General Maintenance Safety

- Turn off engine before checking, adjusting, repairing, lubricating, or cleaning any part of the sprayer.
- When servicing the radiator, let the engine cool before removing pressurized cap.



- Disconnect battery ground cable and turn the Battery Disconnect Switch OFF before servicing the electrical system or welding on the machine.



- Sprayers equipped with All Wheel Steer (AWS) have position sensing internal to the steering cylinders. Disconnect each sensor before welding on the machine. ^

## Spray Booms

- Select a safe area before folding/unfolding booms.
- Clear area of personnel.
- Cradle booms when leaving sprayer unattended.
- Ensure booms are folded when cradled.
- Do not fold/unfold boom extensions when main boom is in the cradle.
- Do not operate sprayer with one boom out of cradle and other boom in cradle.
- Check for overhead obstructions.
- Do not fold or unfold booms near power lines.

### Contact with power lines can result in serious injury or death.

- A warning message will appear on the MD3 Monitor before operating the spray booms. Press “ACK” (acknowledge) showing that you have acknowledged that there are no overhead power lines or obstructions.

## Cold Oil Scenarios

- If the oil temperature is less than 50°F, the operator may experience control loss on the 90-ft. and 100-ft. fold cylinders. These cylinders are the main cylinders affected by over-running loads due to the weight rotation of the boom during fold/unfold situations. When the oil is cold, the valve response is not as fast or accurate. Therefore, when having to lift the weight, the cylinder will move slower, but in trying to suspend the weight, the weight may cause faster movement, as the valve is

not dampening the flow like it normally would.

*NOTE: This situation requires the operator to ensure no one is near the boom during operation.*

## Tread Width

### -If Equipped

- Select tread setting to fit between crop rows.

## All Wheel Steer (AWS) Safety ^

### -If Equipped

Many of the following precautions are repetitious to the precautions for a standard machine. It is imperative they receive special consideration. Failure to comply with the AWS precautions and operating instructions may result in property damage, serious injury, or death.

- Become familiar with and understand how to operate your machine in conventional steering mode before operating with AWS.
- Understand AWS system components, operating procedures, and system limitations before operating.
- Reduce sprayer speed before turning.
- Never drive on hills too steep for safe operation.
- Never drive near ditches, embankments, holes, or other similar obstacles.
- Come to a complete stop before reversing.
- Always drive at a reasonable field speed.

---

---

## SEAT BELT

For your safety, it is recommended that you wear your seat belt at all times when operating the machine.

### Seat Belt Operation

- Grasp the Seat Belt Buckle (located on the outward side of seat) and extend all the way across your hips, seated below your abdomen.

- Insert the buckle tongue into the receptacle assembly (located on the opposite side of seat) and engage into LOCKED position.
- **To release Seat Belt**, press the Release Button (located on the receptacle end) and allow belt to retract.

---

---

## ROTATING BEACON

The Rotating Beacon (located on the left-hand side of the operator's station) is used for increased visibility to others. The beacon will illuminate when the Hazard/Warning Lights Switch is activated.

*NOTE: Hazard Lights are inactive in Field Mode.*



Rotating Beacon  
(Located on the left-hand side  
of the operator's station)  
-Typical View

---

---

## EMERGENCY STOP

### (E-Stop)

## NOTICE

Do not use the E-Stop Switch for non-emergency stopping or as a parking brake.

The E-Stop Switch (located on the side console) provides a quick and positive method for stopping the engine in an emergency situation.

When the E-Stop Switch is depressed, it locks in position and removes the ignition signal to shut down the engine. To reset the E-Stop Switch, turn the switch in the direction of the arrows (located on the face of the button).



Emergency Stop Switch  
(Located on the side console)  
-Typical View

Should the cab door become inoperable, an Emergency Exit Tool (located on the right rear cab frame) is provided and is used in the rare event to shatter the glass of the cab.

- Press the Emergency Exit Tool firmly against the glass to automatically trigger and shatter the glass.



Emergency Exit Tool  
(Located on the right rear cab frame)  
-Typical View

---



---

## EMERGENCY EXIT

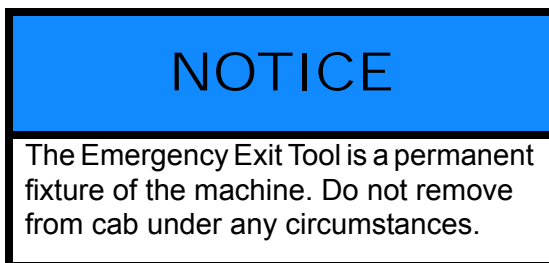
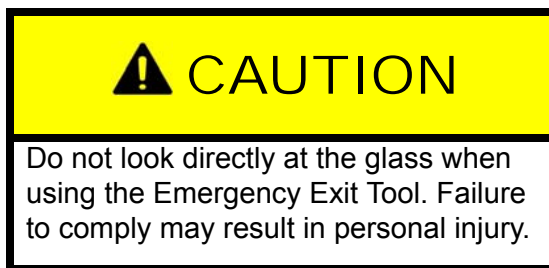

In the event of an emergency, use the cab door to exit the machine.

---



---

## SAFETY DECALS

Decals warning you of avoidable danger are located on various parts of the sprayer. They are there for your personal safety and protection. **DO NOT** remove them. They will fracture upon attempted removal and therefore, must be replaced.

Following are locations of important safety decals. Replace them if they are damaged or missing. All safety decals, instructional decals, or machine striping may be purchased through the Hagie Customer Support Department.

To replace safety decals, ensure the installation area is clean and dry and decide on exact position before you remove the backing paper.

## Safety Decal Locations

650118

(Located on engine compartment in front of air cleaner)



650164

(Located on left-hand rear cab post)



650165

(Located on right-hand rear cab post)



650174

(Located in engine compartment on top of radiator)





**650176**  
(Located near cab door handle)

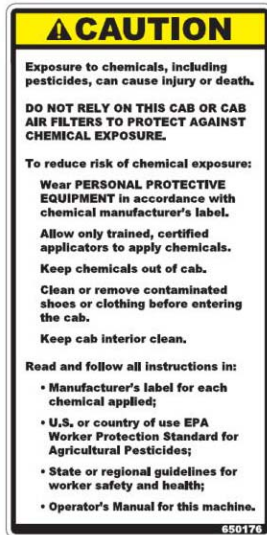

**650217**  
(Located on side of pressure washer)



**650339**  
- Front Cross Member: left-hand side  
- Hydraulic Reservoir: left-hand side of sight gauge

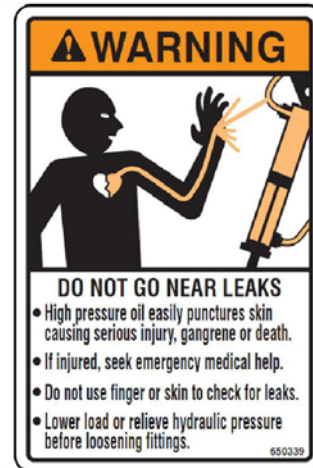

**650178**  
(2) Quick-Tach

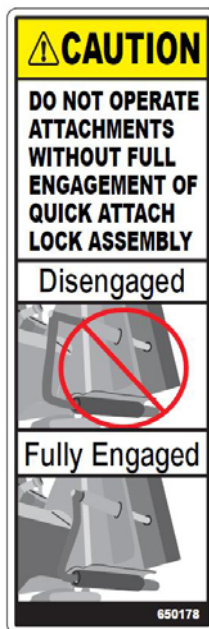

**650401**  
(Located on side-fill and front-fill assemblies)

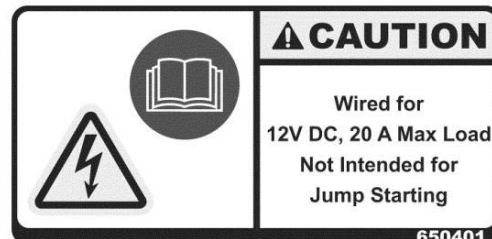

**650432**  
(Located on rear of frame around  
booster terminals)

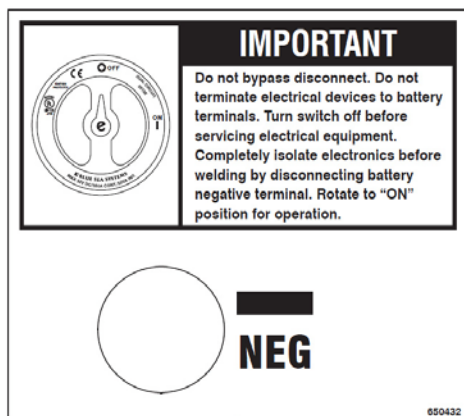

**650849**  
(Located on left-hand side panel near  
fuel cap)

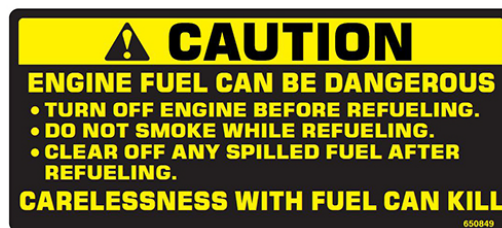

**650850**  
- Front Fill: Located on solution tank  
near fill lid  
- Side Fill: Located on inductor tank lid

**650433**  
(Located on rear of frame around  
booster terminals)



**650851**  
(Located on left-hand side panel near  
rear compartments)



**650848**  
(Located on ladder pivot tube)



**650981**  
(Located near the radiator)



**650982**  
(Located near fuel cell around booster terminals)

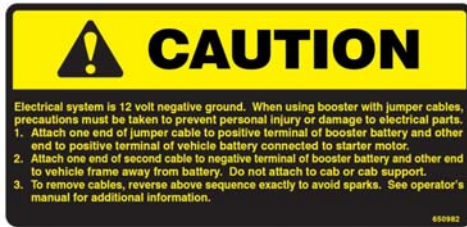

**650204**  
(2) - One located at each folding section along boom



**60/80/90/100-ft. Boom Decals**

**650201**  
(2) - One located at each folding section along boom



**650208**  
(Located on transom)

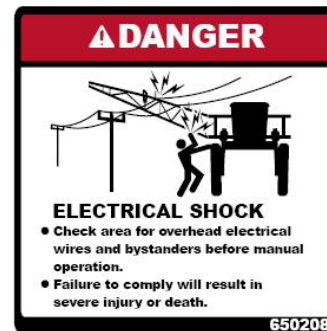

**650203**  
(Located on transom)



**650210**  
(3) - One located on each Norac® sensor



### 120/132-ft. Boom Decals

650201

(2) - One located at each folding section along boom



650208

(Located on fixed transom)



650203

(Located on fixed transom)



650210

(5) - One located on each Norac sensor



650204

(2) - One located at each folding section along boom



CE Supplement  
(Export Machines)



Hagie Part Number: 650248

“Read the Operator’s Manual”  
(Located on left-hand rear cab post)



Hagie Part Number: 650249

“Refer to Service and  
Maintenance Instructions”  
(Located on left-hand rear cab post)



Hagie Part Number: 650257

“Putting hand beyond protective  
guard may result in serious injury  
from a moving fan blade”  
(Located in engine  
compartment above fan guard)



“Electrical Lock-Out Point”  
(Located on underside of machine  
near the electrical lock-out point)  
*\* Refer to operator’s manual  
for lock-out operating instructions*



Hagie Part Number: 650256

“Expulsion of material while servicing. Do  
not stand in the path of discharge to  
avoid possible injury from spray”  
(Located on air tank, underside of  
machine, and near radiator cap)

*NOTE: The wet tank is used only in machines with  
Tier 3 engines.*



Hagie Part Number: 650255

“Exhaust tube may be  
hot enough to burn”  
(Located on top of engine  
compartment near exhaust tube)

*NOTE: Avoid touching the exhaust tube while machine  
is running. Allow the engine plenty of time to  
cool down before performing any service or  
maintenance procedures.*



Hagie Part Number: 650260

“Trip hazard at top of ladder. Use caution  
when climbing onto the machine and  
walking on service platforms”  
(Located on top of ladder and at  
each different platform level)

---

---

## SEAT - OPERATOR

Your sprayer is equipped with an Air Ride Operator's Seat that is featured with the following for your driving and comfort needs.

### Height and Weight Adjustment (A)

- Push or pull the Actuator Lever (located on the left-hand side of seat) (A-1) until the green marking is visible on the seat indicator (A-2).

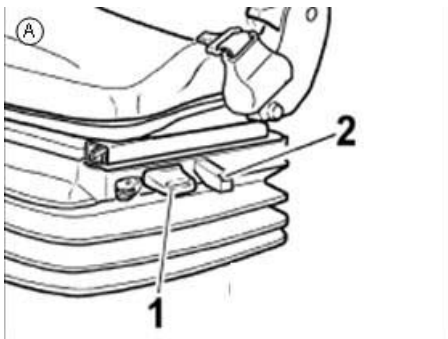

### Fore/Aft Isolator (B)

- Adjust the Isolator Lever (located on the left-hand side of seat) to lock or unlock the seat's lateral movement.

*NOTE: Position 1 is LOCKED and Position 2 is UNLOCKED.*

- After an adjustment from Position 2, the seat must be pushed back until there is an audible "click." Once seat is in the locked position, it is not possible to move it to another position.

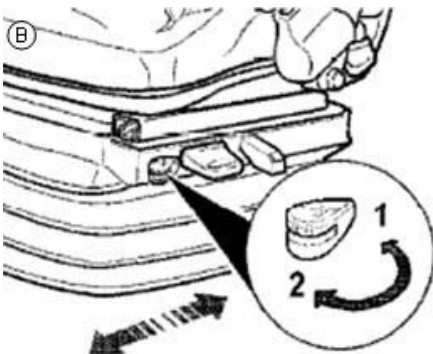

### Fore/Aft Adjustment (C)

- Lift the Adjustment Lever (located on front of seat) to allow personal adjustment.

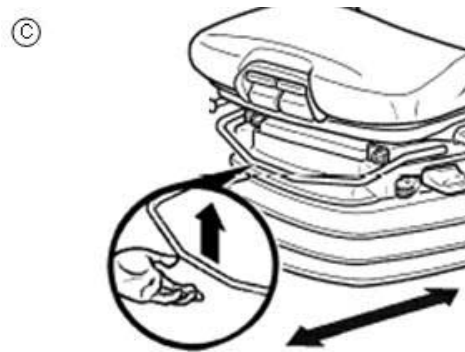

### Seat Pan Angle Adjustment (D)

- Lift the left-hand Angle Handle (located on front of seat) and exert pressure on or off the seat pan to adjust to desired angle.

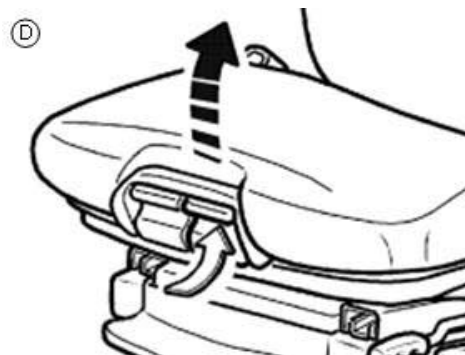

### Seat Depth Adjustment (E)

- Lift the right-hand Depth Handle (located on front of seat) and move the seat cushion forward or backward to desired position.



### Lumbar Support Adjustment (F)

- Turn the Lumbar Knob (located on the mid left-hand side of seat back) to adjust both the height and curvature of the backrest cushion.

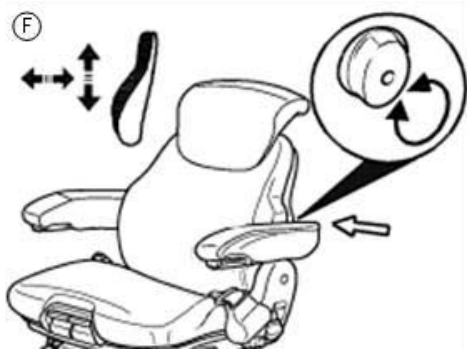

### Armrest Tilt Adjustment (G)

- Turn the Armrest Tilt Knob (located beneath the left-hand armrest) OUTWARD to raise the front of the armrest.
- Turn the Armrest Tilt Knob INWARD to lower the front of the armrest.

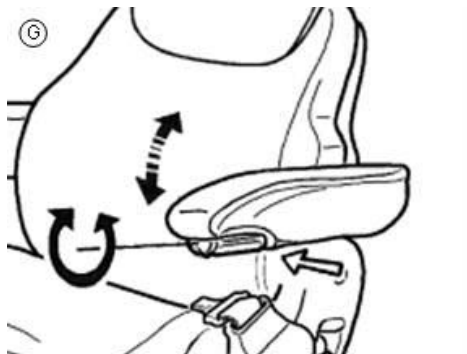

### Backrest Adjustment (H)

- Lift the Backrest Lever (located on the front right-hand side of seat) and apply pressure until you have reached desired position, then release.

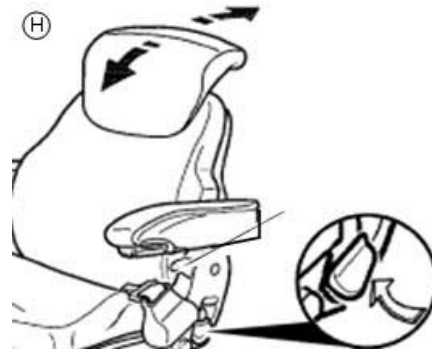

### Absorber Adjustment (I)

- Turn the Absorber Lever to desired level of shock absorbency.

*NOTE: Position 1 (soft), Position 2 (medium), Position 3 (firm).*

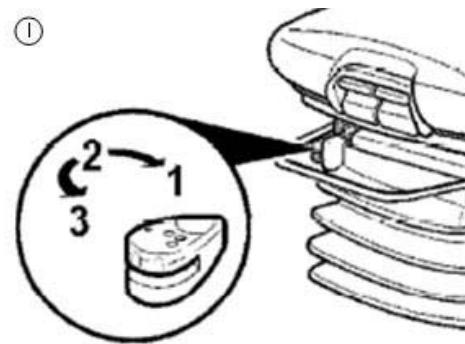

### Seat Belt

Refer to “Seat Belt” provided in the *Safety and Precautions Section* elsewhere in this manual for further information.

---

## SEAT - OPERATOR (PREMIUM)

### -If Equipped

Your machine may be equipped with a Premium Air Ride Operator’s Seat that is equipped with the following features for your driving and comfort needs.



Premium Air Ride Operator's Seat  
-Typical View

### Height and Weight Adjustment (A)

- Press the Height-Weight Adjustment Switch (located on left-hand side of seat) UP to inflate and raise suspension.
- Press the Height-Weight Adjustment Switch DOWN to deflate and lower suspension.

### Fore/Aft Slide Adjustment (B)

- Slide the Fore/Aft Adjustment Lever (located on front side of seat) to the left to UNLOCK and allow for adjustment.

### Isolator Lockout (C)

- Slide the Isolator Lockout Lever (located on the front side of seat) to the right to allow for adjustment.

### Armrest Adjustment (D)

- Rotate the Armrest Adjustment Knob (located beneath left-hand side of armrest) and adjust to desired angle.

### Backrest Adjustment - Recliner (E)

- Rotate the Backrest Adjustment Knob (located on rear left-hand side of seat) FORWARD or BACKWARD to adjust backrest angle.

### Lumbar/Bolster Adjustment (F)

- Rotate the two Lumbar/Bolster Adjustment Switches (located on the left-hand side of seat) to preferred setting.

### Seat Belt (G)

Refer to “Seat Belt” provided in the *Safety and Precautions Section* elsewhere in this manual for proper instruction.

---

---

## SEAT - INSTRUCTOR

The cab area is featured with an Instructor Seat to allow the co-pilot to be seated and instructed on how to operate the machine.



Instructor Seat  
-Typical View

---

---

## OPERATOR'S STATION

### Front Console

- (A) - Hazard/Warning Lights Switch
- (B) - Highway/Running Lights Switch
- (C) - Steering Wheel
- (D) - Turn Signal Indicator
- (E) - Horn
- (F) - Turn Signal Lever
- (G) - Ignition Switch
- (H) - Steering Wheel Tilt Adjust Handle



- (I) - Steering Column Release Pedal



-Typical View



-Typical View



-Typical View

### Hazard/Warning Lights

The Hazard/Warning Lights (A, B, and E - see following photos) are to be used at any time, day or night, that you are traveling on a public roadway, unless prohibited by law.

*NOTE: The machine's drive state must be in Road Mode to activate the Hazard/Warning Lights.*



-Typical View

- To activate the Hazard/Warning Lights, press the Hazard/Warning Lights Switch (located near the steering wheel) in the LEFT (On) position.
- Press the Hazard/Warning Lights Switch in the RIGHT (Off) position to deactivate.



Hazard/Warning Lights Switch  
(Located near the steering wheel)  
-Typical View

### Highway/Running Lights

The Highway/Running Lights are located on the transom mount (C) and on the transom (D). Use these trapezoidal headlamps when traveling on a public roadway at night.



-Typical View

- To activate the Highway/Running Lights, press the Highway/Running Lights Switch (located near the steering wheel) in the LEFT (On) position.
- Press the Highway/Running Lights Switch in the RIGHT (Off) position to deactivate.



Highway/Running Lights Switch  
(Located near the steering wheel)  
-Typical View

Activating the Highway/Running Lights will also turn on the red running lights located on the rear of the machine (F).

*NOTE: The ignition does not have to be on to operate the Highway/Running Lights. However, prolonged use of these lights without the engine running is not recommended.*

### Horn

- The Horn is sounded by pressing the Horn Button (located on the right-hand side of the steering column).



Horn Button  
(Located on the right-hand side of the steering column)  
-Typical View

### Turn Signals

- To activate the Front Turn Signals (A) and the Rear Turn Signals (B and E), move the Turn Signal Lever (located on the left-hand side of steering column) forward (away from operator) to signal a right turn. Move Turn Signal Lever back (toward the operator) to signal a left turn.

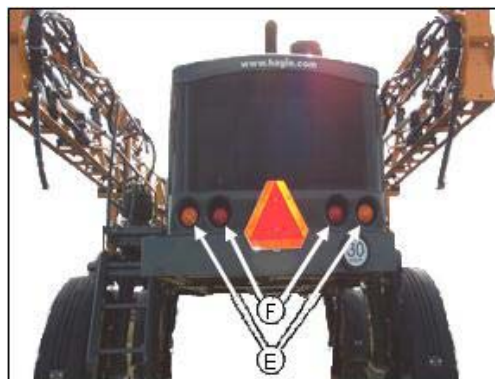

-Typical View



Turn Signal Lever  
(Located on the left-hand  
side of steering column)  
-Typical View

The Turn Signal Lever is not self-centering and must be manually returned to the OFF (mid) position after completing your turn.

*NOTE: Steering column-mounted indicator lights will flash correspondingly when either turn signal is activated.*

### Ignition Switch

The Ignition Switch has three positions - OFF, ON, and START. Before engaging the starter, turn the ignition key to the ON position and wait for the “wait to start” light to disappear on the message center.



Ignition Switch  
(Located on the right-hand  
side of the steering column)  
-Typical View

- **To engage the starter**, turn the key to the START position and hold momentarily until the engine engages. If the engine

does not engage after 15 seconds, turn the key to the OFF position.

*NOTE: Constant cranking of the starter will cause damage to the battery and starting system.*

### Steering Wheel Tilt Adjust

The Steering Wheel Tilt Adjust allows movement of the upper portion of the steering column to best suit your driving needs.

- To adjust the steering wheel, turn the Steering Wheel Tilt Adjust Handle (located on the right-hand side of the steering column) DOWN (toward the operator) to loosen enough to freely move the steering wheel.
- With handle loosened, move the steering wheel to desired position. Hold the steering wheel in position while turning the Steering Wheel Tilt Adjust Handle UP (away from operator) to re-tighten.



Steering Wheel Tilt Adjust Handle  
(Located on the right-hand  
side of the steering column)  
-Typical View

### Steering Column Release Pedal

#### CAUTION

Ensure the steering wheel and steering column are in the locked position before attempting to operate the machine. Failure to comply may result in difficulty maintaining control of the machine.

The Steering Column Release Pedal (located on the lower left-hand side of steering column) is featured for ease of exiting and entering the cab.

- To adjust the steering column, push the Steering Column Release Pedal (located on the lower left-hand side of steering column) and move steering column forward or rearward to desired position.



Steering Column Release Pedal  
(Located on the lower left-hand  
side of steering column)  
-Typical View

- To lock the steering column into position, remove your foot from the Steering Column Release Pedal while holding the steering column in place.
- Firmly move the steering column in either direction to ensure security.

- (M) - Hagie Diagnostic Port
- (N) - Engine Diagnostic Port
- (O) - Hydrostatic Drive Control Handle
- (P) - Foam Marker Switch
- (Q) - Transom Switch
- (R) - Left Boom Switch
- (S) - Right Boom Switch
- (T) - Master Spray Switch
- (U) - Speed Range Switches
- (V) - Solution Pump Switch
- (W) - Rear Nozzle Switch
- (X) - Emergency Stop Switch (E-Stop)



-Typical View

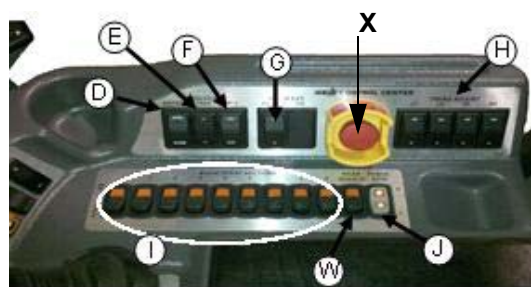

-Typical View

### Side Console

- (A) - Speed Control Dial
- (B) - Throttle Switch
- (C) - Brake/Ladder Switch
- (D) - Agitation Valve Switch
- (E) - Tank Valve Switch
- (F) - Rinse Tank Switch
- (G) - Boom Extension Switch
- (H) - Tread Adjust Switches
- (I) - Boom Solution Valve Switches
- (J) - Fence Row Switch
- (K) - Power Ports
- (L) - Warning Buzzer



-Typical View



-Typical View



Throttle Switch  
(Located on the side console)  
-Typical View

### Speed Control Dial

The Speed Control Dial (located on the side console) helps the operator regain consistent field speed when re-entering a field from the end rows. The Speed Control will maintain it's setting until it is reset.

*NOTE: Speed Control does NOT need to be reset each time the machine is turned off.*

*NOTE: Engine speed can range between 850 and 2500 RPM (Field Mode) and 850 and 2100 RPM (Road Mode).*

The Throttle Switch works with a timer to tell the engine how fast to run. The longer the operator holds the switch in either direction (press UP/“rabbit icon” to increase the speed, press DOWN/“turtle icon” to decrease the speed), the more the engine will speed up or slow down.



Speed Control Dial  
(Located on the side console)  
-Typical View

### Speed Range Switches

The Speed Range Switches (located on the side of the Hydrostatic Drive Control Handle) are used to control speed ranges within the RPM setting.



Speed Range Switches  
(Located on the side of the  
Hydrostatic Drive Control Handle)  
-Typical View

Refer to “Hydrostatic Drive” provided in the *Engine and Drive Systems Section* of this manual for further information.

### Throttle Switch

The Throttle Switch (located on the side console) is used to control engine speed (RPM).

Refer to “Hydrostatic Drive” provided in the *Engine and Drive Systems Section* of this manual for further information.

### Parking Brake/Ladder Switch



Do not engage the Parking Brake while operating the machine. Failure to comply may result in personal injury and machine damage.



The Parking Brake will not engage at speeds over 1 mile per hour (1.6 km/h).

The Parking Brake is not intended for normal or emergency stopping and will not engage if the machine is traveling over 1 mile per hour (1.6 km/h).

*NOTE: Bring the machine to a complete stop before engaging the Brake/Ladder Switch.*

- Press the Brake/Ladder Switch (located on the side console) in the UP (On) position to engage the Parking Brake and lower the Ladder.
- Press the Brake/Ladder Switch in the DOWN (Off) position to disengage the Parking Brake and raise the Ladder.



Brake/Ladder Switch  
(Located on the side console)  
-Typical View

*NOTE: The Brake/Ladder Switch must be in the ON position to operate the side-fill and pressure washer (if equipped).*

### Solution Pump Switch

The Solution Pump Switch (located on the side console) is used to turn the Solution Pump ON/OFF. **This is the ONLY way to turn on/off the Solution Pump.**



Solution Pump Switch  
(Located on the side console)  
-Typical View

*NOTE: Leaving the Solution Pump Switch in the ON position will cause the pump to run continuously, which may result in system damage.*

Refer to the *Spray Systems Section* elsewhere in this manual for further information.

### Boom Solution Valve Switches

The Boom Solution Valve Switches (located on the side console) each control a valve located on the boom or the transom. These valves control the flow of the solution through the boom.

*NOTE: The boom is divided into sections, with the far left tip being the beginning of the first section.*



Boom Solution Valve Switches  
(Located on the side console)  
-Typical View

Refer to the *Spray Systems Section* elsewhere in this manual for further information.

### Agitation Valve Switch

The Agitation Valve Switch (located on the side console) controls the rate of flow through the Agitation System.



Agitation Valve Switch  
(Located on the side console)  
-Typical View

Refer to the *Spray Systems Section* elsewhere in this manual for further information.

### Tank Valve Switch

The Tank Valve Switch (located on the side console) controls the solution tank valve. This switch must be in the ON position to enable spray operation.



Tank Valve Switch  
(Located on the side console)  
-Typical View

Refer to the *Spray Systems Section* elsewhere in this manual for further information.

### Rinse Switch

The Rinse Switch (located on the side console) is used to rinse the solution tank and the booms.



Rinse Switch  
(Located on the side console)  
-Typical View

Refer to “Rinse System” provided in the *Spray Systems Section* elsewhere in this manual for further information.

## Boom Extension Switches

**WARNING**

When operating or positioning the booms, observe the following safety precautions to avoid serious injury or death:

- Select a safe area before unfolding/folding the booms.
- Clear area of personnel.
- Check for overhead obstructions.
- Do not unfold/fold booms near power lines. Contact with power lines can result in serious injury or death.



**CAUTION**

When operating or positioning the booms, observe the following safety precautions to avoid injury or equipment damage.

- Do not unfold/fold boom extensions when main boom is in cradle.
- Do not operate sprayer with one boom out of cradle and the other boom in cradle.
- Do not transport machine without booms folded and in cradle.

The Boom Extension Switches (located on the side console) are used to extend or retract the outer boom extensions.



Boom Extension Switches  
(Located on the side console)  
-Typical View

Refer to the *Spray Systems Section* elsewhere in this manual for further information.

## Tread Adjust Switches

### - If Equipped

The Tread Adjust Switches (located on the side console) are used to hydraulically adjust the tread width.



Tread Adjust Switches  
(Located on the side console)  
-Typical View

Refer to “Tread Adjustment” provided in the *Hydraulic Systems Section* elsewhere in this manual for further information.

## Fence Row Switch

The Fence Row Switch (located on the side console) is used in the selection of the right or left fence row spray nozzles.





Fence Row Switch  
(Located on the side console)  
-Typical View

Refer to “Fence Row Application” in the *Spray Systems Section* of this manual for further information.

### Rear Nozzle Switch

The Rear Nozzle Switch (located on the side console) controls the two (2) rear nozzles (located behind the rear tires).



Rear Nozzle Switch  
(Located on the side console)  
-Typical View

See the *Spray Systems Section* elsewhere in this manual for further information.

### Emergency Stop (E-Stop)

The E-Stop Switch (located on the side console) provides a quick and positive method for stopping the engine in an emergency situation.

*NOTE: DO NOT use this button for non-emergency stopping or as a parking brake.*



E-Stop Switch  
(Located on the side console)  
-Typical View

Refer to “Emergency Stop” provided in the *Safety and Precautions Section* elsewhere in this manual for further information.

### Electrical Ports

(Located on the side console panel)

### Power Ports (A)

Two Power Ports are provided for the connection of additional items (such as radios and computer equipment).

*NOTE: The Power Ports are not intended for the permanent connection of additional systems to the sprayer.*

### Hagie Diagnostic Ports (B)

Two Hagie Diagnostic Ports are provided for the use of a laptop to diagnose machine program errors and machine reprogramming.

These diagnostic ports are to be used by Hagie personnel only. DO NOT use these ports to connect personal digital assistants (PDA’s) or other personal electric equipment.

### Warning Buzzer (C)

A Warning Buzzer is provided to alert the operator when immediate attention of one of the machine’s systems is required.

### Engine Diagnostic Port (D)

An Engine Diagnostic Port is provided to connect directly into the engine. This diagnostic port is to be used by Hagie or

Cummins personnel only. DO NOT attempt to plug into this port with personal electronic equipment.



Electrical Ports  
(Located on back side of the side console)  
-Typical View

### Hydrostatic Drive Control Handle

The Hydrostatic Drive Control Handle is used to control the direction of the machine and the speed in which it travels.



Hydrostatic Drive Control Handle  
-Typical View

Refer to “Hydrostatic Drive” provided in the *Engine and Drive Systems Section* of this manual for further information.

The Hydrostatic Drive Control Handle also controls Spray System and Foam Marker functions. Refer to the *Spray System Section* for further information.

### Foam Marker Switch

The Foam Marker Switch (located on top of the Hydrostatic Drive Control Handle) controls foam application on both sides of the machine.



Foam Marker Switch  
(Located on the Hydrostatic Drive Control Handle)  
-Typical View

Refer to “Foam Marker” provided in the *Spray Systems Section* in this manual for further information.

### Master Spray Switch

The Master Spray Switch (located on the Hydrostatic Drive Control Handle) activates the spray system.



Master Spray Switch  
(Located on the Hydrostatic  
Drive Control Handle)  
-Typical View

Refer to the *Spray Systems Section* elsewhere in this manual for further information.

### Transom Switch

The Transom Switch (located on the Hydrostatic Drive Control Handle) raises and lowers the entire lift.



Transom Raise Switch  
(Located on the Hydrostatic  
Drive Control Handle)  
-Typical View

Refer to the *Spray System Section* elsewhere in this manual for further information.

### Left/Right Boom Switches (Level/Horizontal Extension)

The Left and Right Boom Switches (located on the Hydrostatic Drive Control Handle) are used to raise and lower the booms.



Left/Right Boom Switches  
(Located on the Hydrostatic  
Drive Control Handle)  
-Typical View

Refer to the *Spray Systems Section* elsewhere in this manual for further information.

### Overhead Monitors and Controls

- (A) - Courtesy/Interior Work Light
- (B) - Stereo
- (C) - Climate Controls
- (D) - Wiper/Lights Switch Panel
- (E) - Spray System Console
- (F) - MD3 Monitor
- (G) - Boom Solution Valve LED Indicators
- (H) - Norac® Monitor



-Typical View



-Typical View



-Typical View



-Typical View



-Typical View

\* Model on your machine may differ in appearance



-Typical View



-Typical View



-Typical View

### Courtesy Light/Interior Work Light

The Courtesy Light comes on automatically when the cab door is opened.

The Interior Work Light is activated by manually pressing the right or left edges of the lens.



Interior Work Light Switch  
-Typical View

### Stereo

The Stereo in your cab is featured with an AM/FM Tuner, Weatherband Broadcasting, and CD Player.



Stereo  
-Typical View

Refer to the Stereo manufacturer's operation manual for complete operating instructions and programming information.

### MD3 Monitor

The MD3 Monitor in your sprayer is the central control center of the machine. It controls many of the machine's electronically-driven functions (e.g. machine drive, AWS, attachment operation, tread adjustment, spray system, lights, diagnostics, etc.)



MD3 Monitor  
-Typical View

Refer to "MD3 Monitor" provided elsewhere in this section for further information.

## Climate Controls



Climate Controls  
-Typical View

### Fan Blower Speed (A)

- Rotate the Fan Blower Speed Dial “clockwise” to increase fan speed.
- Rotate the Fan Blower Speed Dial “counter-clockwise” to decrease fan speed.
- To shut the fan off, rotate the Fan Blower Speed Dial fully “counter-clockwise”.

### Temperature Setting (B)

- Rotate the Temperature Setting Dial “clockwise” to increase temperature.
- Rotate the Temperature Setting Dial “counter-clockwise” to decrease temperature.

### Air Conditioner Switch (C)

- To activate the air conditioner, press the Air Conditioner Switch ON (Up). Adjust the fan speed and temperature accordingly.

### Cab Vents

Your cab is equipped with adjustable vents. Rotate vents to desired position, or individually turn on or off with the directional fins.



Vents  
-Typical View

## Windshield Wiper and Washer Fluid Switches

### To activate the Windshield Wipers:

- Press the Windshield Wiper Switch (located on the cab headliner) in the UP (On) position.
- Press the Windshield Wiper Switch in the DOWN (Off) position to deactivate.

The wipers will continue to operate until the switch is turned to the OFF (mid) position.

*NOTE: Replace with a 39” (99 cm) blade as necessary.*



- Windshield Wiper Switch
- Washer Fluid Switch

Windshield Wiper and  
Washer Fluid Switches  
-Typical View

**To activate the Washer Fluid Pump:**

- Press and hold the Washer Fluid Switch (located on the cab headliner) in the UP (On) position until desired amount of fluid is dispensed, then release the switch.

**Field and Work Lights**

**Field Lights**

The Field Lights are located on the front of the exterior cab and are for use when operating in the field after dark.

*NOTE: Turn Field Lights OFF before entering a public roadway.*



Field Lights  
-Typical View

- Press the Field Lights Switch (located on the cab headliner) UP to turn ON.
- Press the Field Lights Switch DOWN to turn OFF.

*NOTE: The ignition key must be in the ON position to operate the Field Lights.*



• Field Lights Switch      • Work Lights Switch

Field and Work Light Switches  
-Typical View

**Work Lights**

The Work Lights are located on each boom cradle and are for use when operating in the field after dark.

*NOTE: Turn Work Lights OFF before entering a public roadway.*

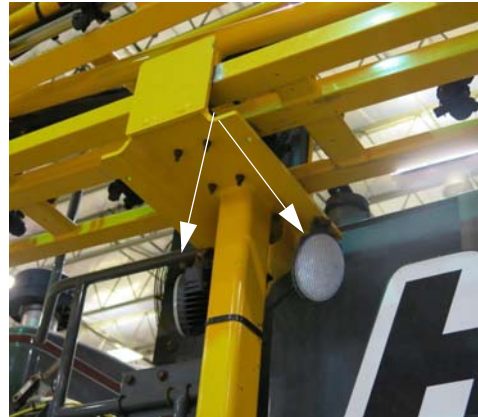

Work Lights  
-Typical View

- Press the Work Lights Switch (located on the cab headliner) UP to turn ON.
- Press the Work Lights Switch DOWN to turn OFF.

*NOTE: The ignition key must be in the ON position to operate the Work Lights.*

**Spray System Console**

The spray system is controlled by the Spray System Console and the Pulse Width Modulated Control Valve. The system receives data and automatically makes adjustments based on the target rate of application set by the operator.



Spray System Console  
-Typical View

\* Model on your machine may differ in appearance

### Norac Monitor

The Norac Monitor (mounted near the Spray System Console) controls the automatic boom leveling system.



Norac Monitor  
-Typical View

Refer to the manufacturer's operation manual for complete operating instructions.



Pulse Width Modulated Control Valve  
-Typical View

Refer to the Spray System Console manufacturer's operation manual for programming information and complete operating instructions.

### Boom Solution Valve LED Indicators

Boom Solution Valve status is displayed by a series of LED indicators (located on the cab headliner). Each indicator light will illuminate when the corresponding Boom Solution Valve is turned OFF.



Boom Solution Valve LED Indicators  
-Typical View

Refer to the *Spray Systems Section* in this manual for further information.

### Fresh Air Filters

Two Fresh Air Filters (charcoal and paper) are located behind the operator's seat. Open panel to access.



Fresh Air Filter Access Panel  
-Typical View

Refer to the *Maintenance and Storage Section* for service and maintenance information. Refer to your Parts Manual for filter replacement information.

---

---

## MD3 SYSTEM

The MD3 System in your sprayer is the central control center of the machine. It controls many of the machine's electronically-driven products, such as:



- Machine Drive
- All-Wheel Steer (if equipped)
- Attachment Operation
- Tread Adjust (if equipped)
- Spray System
- Exterior Lights
- Diagnostics

Push the Up Arrow Button to go to the next page and the Down Arrow Button to go back to the previous page.

## MD3 Monitor

*NOTE: The MD3 Monitor Buttons have been named the following. Please use these terms when speaking with a customer support representative to aid in troubleshooting.*

- (A) - F1
- (B) - F2
- (C) - F3
- (D) - F4
- (E) - Cancel/Home
- (F) - Menu
- (G) - “Up” Arrow
- (H) - OK
- (I) - “Down” Arrow



MD3 Monitor  
-Typical View

## MD3 Page Settings

- Home Page
- Machine Hours Page
- Miscellaneous (Misc) Page

*NOTE: The Home Page will appear each time the machine is started.*

The Up/Down Arrow Buttons are used to toggle and navigate through the pages.



Home Page  
-Typical View



Machine Hours Page  
-Typical View



Miscellaneous (Misc) Page  
-Typical View

## Toggling Between Menu Pages

- To navigate from the Home Page to the Main Menu, press the Menu Button.
- Press the Cancel/Home Button to go back one page at a time while in the

Adjust, Measure, Preferences, and Info menus. Also use this button to go back to the Home Page from the Main Menu.

- Use the F1-F4 Buttons to select the desired group or menu from the Main Menu. Also use these buttons while in the menu for prompted requests.

## Adjusting the Display Lighting

### To adjust the monitor display lighting

- Press the Menu Button.
- Press the F3 Button (under “Preferences”).
- Press the F1 Button (under “Display”).
- Press the F2 Button (under “Backlight” to change the lighting, or press the F3 Button under “Screen Saver” to adjust the time that the screen is lit to it’s full intensity).
- Toggle with the Up/Down Arrow Buttons to desired selection, then press OK.

## Software Version

To view the MD3 System software version, press the Menu Button. Enter the info menu by pressing the F4 Button to view the software version displayed at the top of the page.

## Changing the Tire Size Value

When changing the tire size value, remember that for accurate spray application, the speed of the machine must be accurate.

*NOTE: If the tires are replaced with a different size, this value must be changed.*

- Press the Menu Button.
- Press the F1 Button (A).



- Select “Operator Adjustments”.
- Toggle down to “Tire Size Selector” (B) using the Down Arrow Button (C).
- Press OK (D).



- Toggle to desired tire size.
- Press OK.

## Changing the Unit of Measure

### To change the unit of measure

- Press the Menu Button (A).
- Press the F1 Button (B).
- Use the Up/Down Arrow Buttons (C) to toggle to display adjustments.
- Press OK (D).
- Toggle to “Units Adj” parameter.
- Press OK.
- Toggle to a Value of 1 for standard units, or a Value of 2 for metric units.
- Press OK.



## Home Page

The Home Page displays many features and functions, including the analog tachometer, temperature gauge, fuel gauge, digital gear reading, digital speed reading, time, various warnings, and operating system statuses.

## Clock

The clock is located on the upper left-hand corner of the display screen. The clock is set to central-standard time.

### To change date or time

- Press the Menu Button.
- Press the F3 Button (Preferences).
- Press the F2 Button (Date/Time).
- Press the F1 Button (to adjust the date), or F2 (to adjust the time).
- Press the Up or Down Arrow Button to adjust the date or time to desired value.
- Press OK to accept changes.

## Warning Light Indicator

When an error message requires attention, a red light will illuminate to the right of the clock display (A). This light will be accompanied by a message (B) telling you what the error is and what should be done to correct it.

*NOTE: The error message can be cleared by pressing the F2 Button, but the red light will remain illuminated until the issue has been corrected.*



## Refer to Operator's Manual

When an error has occurred (such as a service interval has been reached) a blue manual icon (A) will appear to the right of the page title. This light will be accompanied by a message (B) indicating that service may be due and to refer to the operator's manual for further information.

*NOTE: The error message can be cleared by pressing the F2 Button, but the blue icon will remain illuminated until the issue has been corrected.*



## Main Spray Indicator

When the Master Spray Switch (located on the Hydrostatic Drive Control Handle) has been activated, a green indicator light will illuminate directly above the tachometer.



Main Spray Indicator  
(Located on the Home Page)  
-Typical View

Refer to the *Spray Systems* section elsewhere in this manual for further information.

## Tachometer

An analog/digital Tachometer is located on the Home Page and displays the engine's revolutions-per-minute (RPM).



Tachometer  
(Located on the Home Page)  
-Typical View

## Temperature Gauge

An analog Temperature Gauge (A) is located next to the Tachometer in the center of the Home Page. This gauge indicates the temperature of the engine. If the engine coolant temperature reaches a level that is too high, a warning icon (B) will illuminate directly above the gauge.



If engine temperature continues to rise after the initial warning icon, a second warning (C) will appear shortly before the machine begins to go into protective mode, alerting you that the engine coolant temperature is too high.



If this warning appears, immediately reduce the engine speed and allow the engine to idle. This will allow the cooling system to cool the engine down and prevent possible damage. Contact the Hagie Customer Support department if troubleshooting assistance is needed.

When this warning appears, the machine may be severely limited in engine and hydraulic functions (to prevent possible damage to those systems).

*NOTE: The warning can be cleared and the alarm silenced by pressing the F2 Button. A red warning light (D), located to the right of the clock display, will remain illuminated and continue to flash until the issue has been corrected.*

## Fuel Gauge

The Fuel Gauge is a bar indicating the amount of fuel in the tank. Below the Fuel Gauge bar is a digital reading that indicates the number of gallons (liters) in the tank.

When fuel level reaches a minimum level, a warning light will appear directly above the gauge.

*NOTE: The low fuel warning light will not disappear until the fuel level is above the minimum level.*



Fuel Gauge  
(Located on the Home Page)  
-Typical View

## Gear Display

The gear (speed range) in which the machine is traveling is displayed on the upper right-hand side of the display screen.

*NOTE: There are five (5) gears in both Road and Field Modes.*



Gear Display  
(Located on the Home Page)  
-Typical View

## Speedometer

The speed in which the machine travels is displayed directly below the gear reading (located on the right-hand side of the display screen).

The unit of measure can be changed from miles per hour (MPH) to kilometers per hour (km/h). The unit of measure is displayed to the right of the word “Speed”.



Speedometer  
(Located on the Home Page)  
-Typical View

## Reversible Fan

The Reversible Fan is controlled through the Machine Hours Page. Press the F1 Button to activate.



Refer to “Hagie Reversible Fan” provided in the *Miscellaneous* section elsewhere in this manual for complete operating instructions, safety precautions, and maintenance information.

## Drive State (F1)

The Drive State of the machine is displayed on the bottom left-hand side of the display screen (A).

*NOTE: The machine's Drive State cannot be changed unless the Hydrostatic Drive Control Handle is in the NEUTRAL position.*

The machine is featured with three (3) Drive States: ROAD, FIELD, and FAULT. The Drive State helps the machine determine what kind of work it is meant to do - field work or transport work.



### Road Mode

In Road Mode, the machine is limited on what functions can be operated. For example, attachment functions are inoperable in Road Mode.

Road Mode is used for transporting of the machine and therefore, will allow the machine to reach maximum speed.

*NOTE: Engine speed in Road Mode can range from 850 to 2100 RPM.*

### Field Mode

In Field Mode, the machine is allowed function of attachments, such as the Spray Booms and Nitrogen Toolbar (if equipped). All-Wheel Steer (if equipped) is also only allowed in Field Mode.

*NOTE: Machine speed is limited and is unable to reach maximum speed while in Field Mode.*

*NOTE: Engine speed in Field Mode can range from 850 to 2500 RPM.*

## Drive Fault

The third drive state, “Drive Fault” may appear as a warning message on the display screen (B) if there is a system error that affects the machine’s ability to function properly. This message will tell you why the error occurred and what, if anything, should be done to correct the issue. As a result, machine performance will be limited.



*NOTE: Severe warnings will be accompanied by a shut-down or power-down of systems to protect the machine (C). This Drive State is automatic and cannot be voluntarily selected.*



To toggle between the two Drive States (Road and Field Mode), ensure there are no drive faults present and that the machine is in NEUTRAL. Press the F1 Button until the desired Drive State appears on the display screen.

## Function Button (F2)

Warnings that appear on the display screen (e.g. drive faults, service issues, system errors, etc.) will be acknowledged by pressing the F2 Button.

## All-Wheel Steer (F3) ^

### -If Equipped

The F3 Button is associated with the All-Wheel Steer (AWS) system (if equipped).

*NOTE: “AWS” will appear on the display screen even if it is not installed on your machine (A).*



All conditions must be met before AWS will activate. First, the machine must be in Field Mode, and second, machine speed must be less than AWS shutoff gear speed. If these conditions are not met, AWS will remain on, but the machine will still be operating in conventional steering mode.

The F3 Button will only enable AWS, as the machine will automatically determine if the proper conditions are met and change the status of the drive functions.

When AWS is activated, the display screen will read either “Coord1” or “Coord2” (coordinated steering) (B), depending on machine speed. If AWS is engaged but not activated, the display will read “Normal”, meaning that you are in conventional steering mode, but AWS will automatically activate when the proper conditions are met. When AWS is not on, the display screen will read “OFF”.



## Float (F4)

The F4 Button is associated with Float operation and will only appear if the Nitrogen Tool Bar (if equipped) is installed on the machine. When the NTB is removed from the machine, there will be “dashes” that appear on the display screen.



Refer to your NTB operator’s manual for further information on Float operation.

## Machine Hours Page

The Machine Hours Page can be found by using the Down Arrow Button (A) to toggle from the Home Page.



The Machine Hours Page is a service tool for operators to set and track service intervals (50 hours, 100 hours, 500 hours, etc).

Some of the service intervals can be adjusted to suit your preference if you do not want to wait as long as possible to perform some of the services (e.g. oil and filter servicing). The default on the Machine Hours Page are the recommended practices of the engine manufacturer. However, certain service intervals may be performed on shorter intervals than what is recommended.

*NOTE: The default will not be able to extend past the engine manufacturer's recommendation.*

A manual icon (B) will appear at the top of the Home Page along with a message (C) informing you that a service interval has been reached.



*NOTE: The message can be cleared by pressing the F2 Button, but the manual icon will remain illuminated until the interval hours have been reset.*

Refer to the *Maintenance and Storage* section elsewhere in this manual for further information on service intervals.

## Adjusting Service Intervals

The Machine Hours Page has three (3) information columns: The first column tells you what service action or interval the hours are referring to. The second column tells you the hours since last service. This third column tells you how many hours before the next service is due.

*NOTE: The engine oil/filter, hydraulic filter, and hydraulic oil intervals can be adjusted to best suit your needs. All other intervals cannot be adjusted.*

## To adjust service intervals

1. Press the Menu Button (A).



2. Press the F1 Button (Adjust).
3. Press the Down Arrow Button to toggle down to the Service Interval Group (B).



4. Press OK.
5. Adjust to desired interval.
6. Press OK to accept changes.

## Resetting Service Hours

Once a service procedure has been completed, the hours must be reset.

### To reset service hours

1. Press the Menu Button.
2. Press the F1 Button (Adjust).
3. Press the Down Arrow Button and select the "Service Reset Group".
4. Reset the parameters by toggling the parameters to 1, then back to 0 using the Up/Down Arrow Buttons.



## Miscellaneous (Misc) Page

The Misc Page is information only and provides you with current tire size, tread adjust, and the tread setting on both the left and right side separately.

*NOTE: No adjustments can be made from the Misc Page.*

## 120/132-ft. Spray Boom Information

### - If Equipped

120/132-ft. Spray Boom information is provided on the Misc Page.



120/132' Spray Boom Information  
(Located on the Misc Page)  
-Typical View

Refer to the *Spray Systems* section elsewhere in this manual for further information.

## SECTION 4 – ENGINE AND DRIVE SYSTEMS

**WARNING**

**CALIFORNIA PROPOSITION  
65 WARNING**

**WARNING:** Diesel engine exhaust and some of its constituents are known to the State of California to cause cancer and birth defects or other reproductive harm.

**WARNING:** Battery posts, terminals, and related accessories contain lead and lead compounds, and chemicals known to the State of California to cause cancer and birth defects or other reproductive harm.

### Pre-Operational Checklist

1. Check engine oil level.

*NOTE: Do not operate the machine when oil level is below the “low” mark on the engine oil dipstick.*

2. Check coolant level.
3. Check hydraulic reservoir oil level.
4. Check cooling air intake screen.
5. Check Filter Minder®.
6. Drain fuel/water separator.
7. Check engine drive belt.
8. Drain water out of the air tank.
9. Check for any oil or fuel leaks.

### Cold Start Procedure

1. Place the Hydrostatic Drive Control Handle in the NEUTRAL position.

## ENGINE - STARTING

**WARNING**

**DO NOT USE ETHER!**

Engine equipped with electronic starting aid. Use of ether may cause explosion and severe injury.

650118

**CAUTION**

Start the engine from the operator’s seat only. When running the engine in a building, ensure there is adequate ventilation.

**NOTICE**

Cold oil may not flow in quantities adequate to prevent pump cavitation.



Hydrostatic Drive Control Handle  
-Typical View

2. Engage the Parking Brake.

**To engage the Parking Brake**, press the Brake/Ladder Switch (located on the side console) in the UP (On) position.



Brake/Ladder Switch  
(Located on the side console)  
-Typical View

*NOTE: The Parking Brake also controls the Ladder. When the Parking Brake is engaged, the Ladder will extend (lower). When the Parking Brake is disengaged, the Ladder will retract (raise).*

3. Turn the Ignition ON, but DO NOT engage the starter. (**Wait for the “Wait to Start” warning light and message to disappear on the message center.**)

*NOTE: Ensure that there are no other warnings before proceeding.*

4. Engage the starter.

**(If the engine fails to start after 15 seconds, turn the key OFF, wait one minute, and repeat the procedure. If the engine does not start after three attempts, check the fuel supply system).**

*NOTE: Absence of blue or white exhaust smoke while cranking indicates that no fuel is being delivered.*

5. Observe warning lights on the MD3 Monitor (after start-up).

*NOTE: If any functions do not operate, shut the engine OFF and determine cause.*

6. Allow a warm-up period of at least 5 minutes before operating the engine at a high RPM.

*NOTE: The engine must reach operating temperature and oil pressure must stabilize in the normal operating range before it is run faster than idle speed (1,000 RPM or less).*

---



---

## HYDROSTATIC DRIVE

The Hydrostatic Drive System uses pressurized hydraulic fluid to drive the machine. The Hydrostatic Drive System consists of four components: Diesel Engine, Tandem Hydrostatic Pumps, Front and Rear Wheel Motors, and Wheel Hubs.

### Hydrostatic Drive Components

- Cummins® Diesel Engine
- Tandem Hydrostatic Pumps
- Front and Rear Wheel Motors (4)
- Wheel Hubs (4)

### Engine and Hydrostatic Pumps

Your machine is featured with a 365hp (272 KW) diesel engine (equipped with an automatic exhaust brake). The engine has direct-mounted Tandem Hydrostatic Pumps.



Diesel Engine  
-Typical View



Tandem Hydrostatic Pumps  
-Typical View

## Wheel Motors and Hubs

The all-time 4-wheel drive system consists of Hydrostatic Wheel Motors and Gear Reduction Hubs (Wheel Hubs) located on each wheel.



Wheel Motor  
-Typical View



Wheel Hub  
-Typical View

## Parking Brake

The Parking Brake will engage when applied hydraulic pressure falls below 150 PSI (10.3 bar) or if the engine is shut off.

### CAUTION

Do not engage the Parking Brake while operating the machine. Failure to comply may result in personal injury and machine damage.

### NOTICE

The Parking Brake will not engage at speeds over 1 mile per hour (1.6 km/h).

The Parking Brake is not intended for normal or emergency stopping and will not engage if the machine is traveling over 1 mile per hour (1.6 km/h).

*NOTE: Bring the machine to a complete stop before engaging the Parking Brake.*

The Parking Brake also controls the Ladder. When the Parking Brake is engaged, the Ladder will extend (lower). When the Parking Brake is disengaged, the Ladder will retract (raise).

- **To engage the Parking Brake and lower the Ladder**, press the Brake/Ladder Switch (located on the side console) in the UP (On) position.



Brake/Ladder Switch  
(Located on the side console)  
-Typical View

- **To disengage the Parking Brake and raise the Ladder**, press the Brake/Ladder Switch in the DOWN (Off) position.

## Speed Control

Machine speed control may be adjusted by using the Speed Control Dial (located on side console) to help regain consistent field speeds when re-entering a field from the end rows.



Speed Control Dial  
(Located on the side console)  
-Typical View

### To Set Speed Limit

- Move the Hydrostatic Drive Control Handle all the way FORWARD.



Hydrostatic Drive Control Handle  
-Typical View

- While observing ground speed, slowly turn the Speed Control Dial “clockwise” until desired speed is obtained.

Maximum field speed is now set.

Reposition Hydrostatic Drive Control Handle fully forward to regain newly set speed.

### Throttle Switch

The Throttle Switch (located on the side console) is used to control engine speed (RPM).



Throttle Switch  
(Located on the side console)  
-Typical View

*NOTE: Engine speed can range between 850 and 2100 RPM in Road Mode, or between 850 and 2500 RPM in Field Mode.*

The Throttle Switch works with a timer to tell the engine how fast to run. The longer the operator holds the switch in either direction (press UP/“rabbit icon” to increase the speed, press DOWN/“turtle icon” to decrease the speed), the more the engine will speed up or slow down.

### Drive System Control

Speed ranges are selected by pressing the Speed Range Switches (located on the side of the Hydrostatic Drive Control Handle).

- Press the “Green” Speed Range Switch to INCREASE speed range.
- Press the “Red” Speed Range Switch to DECREASE speed range.



Speed Range Switches  
(Located on the side of the  
Hydrostatic Drive Control Handle)  
-Typical View

*NOTE: The NEUTRAL position must be met before changing the direction of the machine.*

- **To move the machine forward**, slowly push the Hydrostatic Drive Control Handle FORWARD.

*NOTE: The further the handle is moved forward, the faster the machine will travel and the engine speed will increase.*

- **To move the machine in reverse**, slowly pull the Hydrostatic Drive Control Handle backward.

*NOTE: The further back the handle is pulled, the faster the machine's speed.*

- **To stop the machine**, slowly place the Hydrostatic Drive Control Handle in the NEUTRAL position.

*NOTE: Before turning the engine off, reduce engine speed and allow to idle for a minimum of three (3) minutes.*

## NOTICE

The operator can choose a minimum level above 850 RPMs of engine speed that they want to operate the machine with by using the Throttle Switch.

## ALL-WHEEL STEER (AWS)

### -If Equipped

**^ Operator's with machines equipped with All-Wheel Steer pay special attention!**

## NOTICE

Become familiar with the machine in both coordinated and conventional steering modes before attempting to use the machine for it's intended use. ^

*NOTE: Read the following AWS information thoroughly and understand the operating instructions and safety precautions before operating.*



Hagie Manufacturing Company recommends becoming familiar with and understanding how to operate your machine in conventional steering mode before operating AWS. Understand AWS system components, operating procedures, and system limitations before operating.

The term “coordinated steering” is used to describe the AWS feature. Coordinated steering is when the front wheels turn one direction and the rear wheels turn in the opposite direction to create a tighter turn angle, which allow the rear wheels to follow the front wheel tracks. Operating your machine in AWS mode makes turning more efficient by minimizing crop damage and ground disturbance.

Ensure you are comfortable driving the machine on the road and in the field, with the booms in the transport and spray positions, as well as performing a variety of different turning scenarios before attempting to operate AWS.

## Progressive AWS

Hagie Manufacturing Company’s Progressive AWS takes the original design and increases the active speed range while maintaining a safe turning radius. This is done by limiting how far the rear wheels will turn at higher speeds. The improvement allows operators to follow contours in the field and leave only one set of wheel tracks. This also allows them to make wide turns on end rows with only one set of wheel tracks.

Your rear wheels will track the front wheels, with limitations on speed and turning percentage. This is completely variable, so if you accelerate in a turn, your match on the rear will slowly come out. This feature keeps the machine safe when turning.

*NOTE: If you want to match all the time, decrease your speed or make a less drastic turn.*

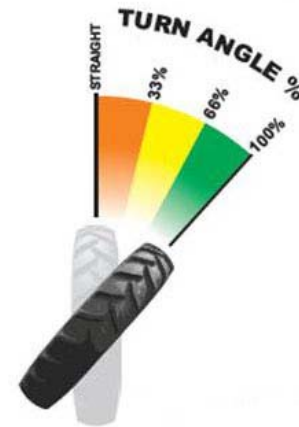

### Example A:

The operator wants to do contour rows with an STS10 (with 54” tires), spraying at 10 mph (16 km/h). The steering wheel is adjusting the front wheels and the rear wheels will only turn to a maximum of 33%, and therefore, follow the front tire tracks to that same value. If the rows take more than 33% turn to follow, the rear wheels will more than likely run over the crop unless the operator decreases speed to gain back more turn angle on the rear wheels.

### Example B:

The operator wants to turn on the end rows at 8.8 mph (14.2 km/h) with an STS10 (with 46” tires), but also desires the two-wheel track pattern. This is achieved as long as the front wheels are not turned more than 66% of the maximum turn angle. If speed increases past 8.8 mph (14.2 km/h), the rear wheel turn angle will reduce automatically and the front and rear tire track will no longer match.

## Terminology

### Conventional Steering

Only the front wheels turn.

### Coordinated Steering ^

All the wheels turn and do so where the rear tires follow in the front tires’ tracks.

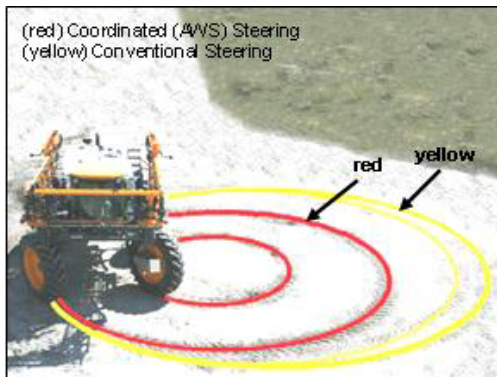
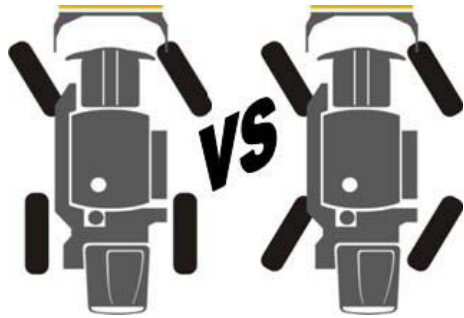

## Components

The Steering Cylinder (internal position) and External Proximity Sensors are used to track cylinder rod extension.

### Steering Cylinders



Steering Cylinder  
(Located on the rear legs)  
-Typical View

### External Proximity Sensors



External Proximity Sensor  
-Typical View

### Lock Valves

Each rear cylinder is equipped with two (2) Lock Valves, which lock the cylinders into position when in Road mode.

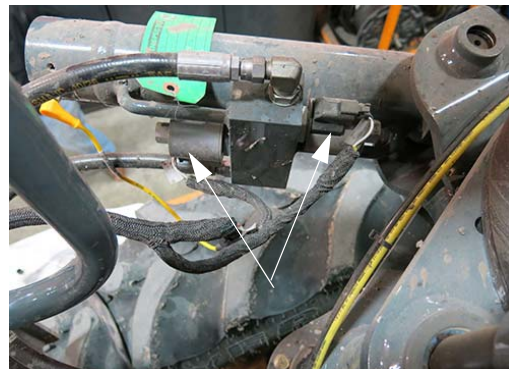

Lock Valves  
-Typical View

### Valve Block

Rear hydraulic steering is controlled by a Valve Block (located on the underside of the machine).





Valve Block  
(Located on the underside of machine)  
-Typical View

## Operating AWS

All conditions must be met before AWS will activate. First, the machine must be in Field Mode, and second, machine speed must be less than AWS shutoff gear speed. If these conditions are not met, AWS will remain on, but the machine will continue to operate in conventional steering mode. When conditions are met again, AWS will automatically activate.

*NOTE: The machine will automatically determine if the proper conditions have been met and change the status of the drive functions.*

1. Ensure the machine's drive state is in Field Mode.
2. Press the F3 Switch (located on the MD3 Monitor) to enable AWS.

*NOTE: When AWS is activated, "ON" will appear next to the AWS display on the MD3 Monitor.*



F3 (AWS) Switch  
(Located on the MD3 Monitor)  
-Typical View

The machine will remain in AWS mode, which will allow the system to be active until either a system limitation is reached or the operator turns the F3 (AWS) Switch (located on the MD3 Monitor) to the OFF position.

## Setting AWS Shutoff Gear

AWS will shut off (revert back to conventional steering mode) when the speed range is greater than the AWS Shutoff Gear.

### Example:

*If AWS Shutoff Gear is set to 3, AWS will activate when the machine is in Speed Ranges 1-3. AWS will deactivate when the machine is in Speed Range 4.*

1. Press the Menu Button (located on the MD3 Monitor).



Menu Button  
(Located on the MD3 Monitor)  
-Typical View

2. Press the F1 Button (located on the MD3 Monitor) to navigate to the “Adjust” screen.
3. Using the Arrow Buttons, scroll to “Operator Adjustments”.



“Adjust” Screen  
-Typical View

4. Press OK.
5. Using the Arrow Buttons, scroll to “Shutoff Gear for AWS”.



“Operator Adjustments” Screen  
-Typical View

6. Press OK.
7. Enter desired value (AWS Shutoff Gear).

### Limitations Include

- Machine is shifted out of first or second gears while in Field Mode. Also, machine limitation is met while in second gear.

*NOTE: There is no warning message associated with this. The machine will automatically switch to conventional steering mode.*

- The machine’s drive state must be in Field Mode. If the machine is in Road

Mode, AWS is disabled (and the rear cylinder Lock Valves are locked).

*NOTE: There is no warning message associated with this. The machine will be in conventional steering mode.*

- System Fault - The system is not working properly (e.g. sensor malfunction, hydraulic issue, etc.)

*NOTE: A warning message will appear on the MD3 Monitor and the machine may be limited on speed and other functions.*

- **Auto Steer Machines Only:**  
When Auto Steer is engaged, it will automatically turn the AWS System OFF and move the rear wheels back to straight.

### Recommendations for Best Operating Practices

- Press the Speed Range Switches (located on the side of the Hydrostatic Drive Control Handle) to decrease speed at end rows.
- In Field Mode, first speed range will decrease speed enough to make a turn.



Speed Range Switches  
(Located on the side of the Hydrostatic Drive Control Handle)  
-Typical View

- Use the Hydrostatic Drive Control Handle to slow down more if needed. If you move the Hydrostatic Drive Control Handle first and then shift down to get to AWS mode, you will notice that the machine may slow down more than intended.
- Understand how the machine feels when it is still in a turn and is shifted out of AWS shutoff gear. You will notice that to stay away from these scenarios, you can wait to shift out of first or second gear until the front wheels are closer to the straight position.

The machine will still operate at whatever turn angle that you want to shift out at, but you may feel that this situation is causing an operation that you may not want (possibly getting the machine off the line intended because the rear wheels move back to straight position and the total turning radius will change).

In the following illustration, the two circles represent a full turn with AWS on. The - - - lines represent the direction the operator wants the front tracks to go (assuming the operator wants to pull the machine back into rows that are running straight up and down.) The -.-.-.- lines represent the direction that the front wheels are pointed when the operator shifts out of AWS speed range. If this occurs, the rear wheels will shift back to the straight position and the machine will no longer have the two tire tracks (two circles). The rear wheels will begin to follow the -.-.-.- path during this shift.

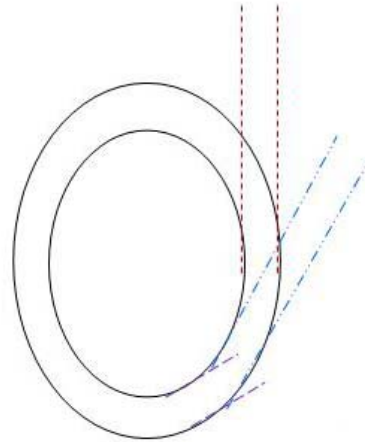

Hagie Manufacturing Company once again strongly recommends trying out and getting a feel for the AWS System before going straight to the field so you can get an understanding of what to expect. Some situations to try include:

- Driving the machine with both an empty and a full solution tank with AWS ON.
- Drive the machine on hills, ensuring to take the proper precautions as stated in the *Safety and Precautions Section* elsewhere in this manual.
- Drive the machine at different turn angles and speeds to see how the limitations work.

*NOTE: You will notice that if you go over any of the limitations, you can slow back down and the AWS system will automatically turn itself back on.*

- **Auto Steer Machines Only:** Notice how the machine feels when in AWS mode and switching from Auto Steer ON to OFF, especially when turning.
- Contact Hagie Customer Support with any questions you may have regarding the operation of the AWS System.

## HYDRAULIC SYSTEM COMPONENTS

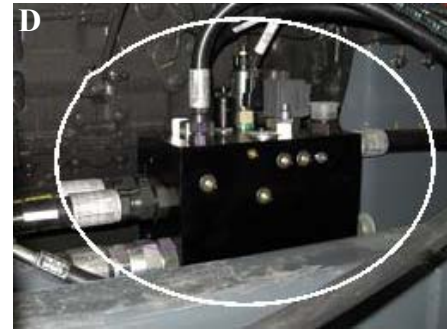

### Auxiliary Hydraulic System (Hydraulic Pump and Gear Pump)

The Auxiliary Hydraulic System is a load sensing, pressure-compensated system with efficiency in mind. Therefore, it only pumps the amount of oil needed to do the job.

The pump is mounted to the front of the second Hydrostatic Pump. The system consists of a single variable displacement pump that supplies the required hydraulics to operate the full-time power steering unit, boom control cylinders (lift, level, and fold), outer boom breakaway, solution pump, tread adjust, and ladder.

The pump circulates hydraulic oil throughout the necessary systems and back through a cooler before returning it to the reservoir.

*NOTE: If the level in the reservoir drops too low for safe operation, you must shut down the engine immediately to prevent damage to the hydraulic system.*

Return oil from the load sense pump is mixed with oil from the Gear Pump. This pump supplies a constant flow of oil from the hydraulic tank to the cooler and then back to the tank through the filter. This is considered a “kidney loop” and is dedicated to the cooling and filtration of the hydraulic system.

The Gear Pump is equipped a dedicated steering pump, which ensures that the steering circuit is receiving the flow that is needed.

## Hydraulic Machine Components

- (A) - Hydraulic Pump
- (B) - Gear Pump
- (C) - Power Steering
- (D) - Fan Control Valve

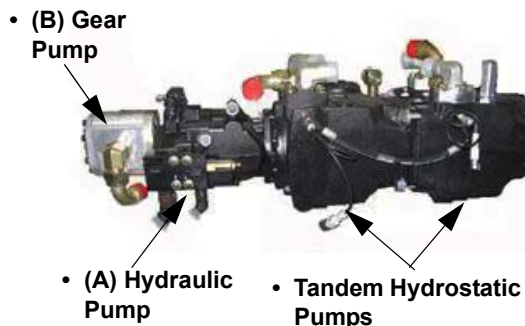

### Power Steering

The Power Steering System is a true, dedicated steering circuit. No other function will share oil with the steering circuit with full-time control, re-phase centering, master slave steering circuit on front steering, and double action steer by position with rear steering.

### Fan Control Valve

The engine and auxiliary cooling fans are hydraulically-controlled by the Fan Control Valve (located on the right-hand side of engine). Reversing the fan rotation is primarily used to remove small debris from the fan/grille screens.

Refer to “Reversible Fan” provided in the *Miscellaneous Section* elsewhere in this manual for further information.

### Hydraulic Filtering/Cooling Return Components

- Oil Cooler
- Reservoir
- Return Filter
- Breather Cap

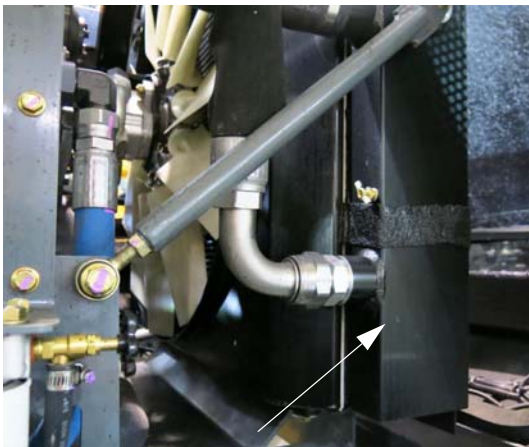

Hydraulic Oil Cooler  
(Located on left-hand side of machine - open hood to access)  
-Typical View



Hydraulic Oil Reservoir  
(Located on left-hand side of machine - open hood to access)  
-Typical View

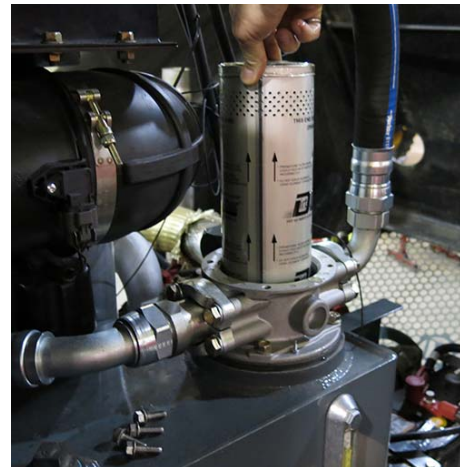

Hydraulic Return Filter  
(Located inside filter housing on top of hydraulic oil reservoir)  
-Typical View



**Breather Cap**  
(Located on top of hydraulic oil  
reservoir - open hood to access)  
-Typical View

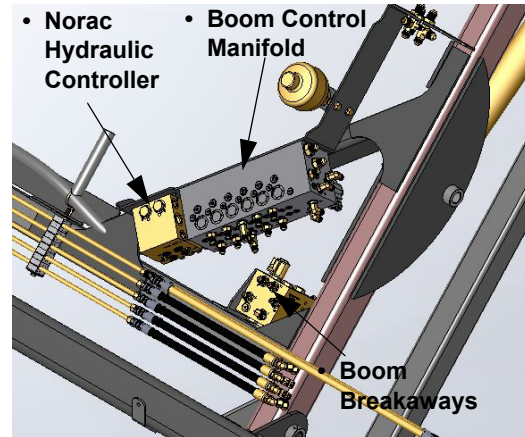

**Boom Control Manifold and  
Norac Hydraulic Controller - if equipped**  
(Located on the boom lift arm assembly)  
-Typical View  
\* 90-ft. Spray Boom Shown

## Hydraulic Spray System Components

- Solution Pump
- Boom Control Manifold
- Norac® Boom Leveling System (if equipped)



**Solution Pump**  
(Located near front  
right-hand side of machine)  
-Typical View

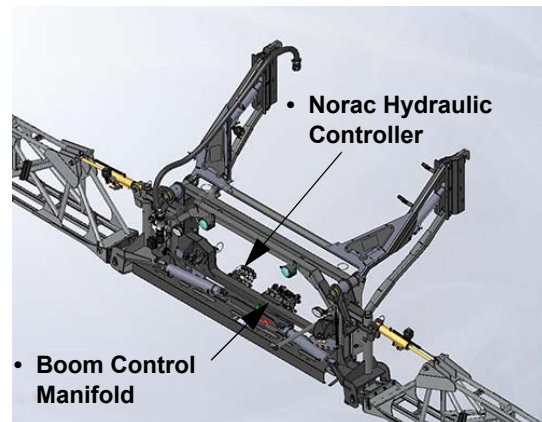

**Boom Control Manifold and  
Norac Hydraulic Controller**  
(Located near center of inner transom)  
-Typical View  
\* 120/132-ft. Spray Booms

Refer to the *Spray Systems Section*  
elsewhere in this manual for further  
information.

## REVERSIBLE FAN

### WARNING

Improper operation, maintenance, or repair of this product can be dangerous and may result in serious injury or death.

- Always use Hagie-approved parts and components. Failure to comply will result in voiding the parts warranty.
- Do not operate or perform any service on this product until you have read and understand the operation and maintenance information. Contact Hagie Manufacturing Company for any additional information that you may require.
- The person(s) servicing the product may be unfamiliar with many of the systems or components of the product. Use caution when performing service. Knowledge of the product and components are important before the removal or disassembly of any component.

The Reversible Fan is a hydraulically-driven constant pitch fan. Fan speed is controlled based on cooling demand. A signal is sent to the Hydraulic Valve Block (located near the rear right-hand service platform - open hood to access), which controls the speed and direction of the fan.

Refer to all safety information provided in this manual before performing any service or maintenance.



Reversible Fan  
(Located near rear of machine  
- open hood to access)  
-Typical View



Hydraulic Valve Block  
(Located near the rear right-hand  
service platform - open hood to access)  
-Typical View

### To Activate the Reversible Fan

### NOTICE

The Hydrostatic Drive Control Handle must be in the NEUTRAL position to operate the Reversible Fan. The machine must remain in the neutral position until the reversing cycle is complete.

*NOTE: The Reversible Fan can be activated at any time while the machine is running.*

- Navigate to the Machine Hours Page (located on the MD3 Monitor).
- Press and hold the F1 (Reversible Fan) Button to activate the fan.



F1 (Reversible Fan) Button  
(Located on the MD3 Monitor)  
-Typical View

*NOTE: When the reversing cycle is activated, “Reversing Fan” will appear on the lower left-hand side of the MD3 Monitor Machine Hours Page.*

## Service and Maintenance

**WARNING**

Ensure the Battery Disconnect Switch is in the OFF position before performing any service or maintenance on the fan. Failure to comply may result in engine turnover, serious injury, or death.

Under normal operating conditions, the Reversible Fan does not require scheduled maintenance and is built to provide thousands of hours of trouble-free service.

In moderate to extreme operating conditions, a visual inspection of moving parts is recommended from time to time to safeguard against fan blade damage, which could lead to equipment and/or other damage.

## TREAD ADJUSTMENT

### To Adjust Tread Widths

**CAUTION**

Never adjust the hydraulic tread width on a public roadway. Ensure the machine is on level ground where there are no ditches or valleys to interfere while you perform the adjustment.

1. Survey your surroundings and allow yourself enough room to adjust the tread in either forward or reverse.
2. While driving one or two miles per hour (1.6 to 3.2 km/h), press and hold the desired Tread Adjust Switch(es) (located on the side console) to adjust tread width.
  - Press and hold Tread Adjust Switch UP to move tread OUT.
  - Press and hold Tread Adjust Switch DOWN to move tread IN.



Tread Adjust Switches  
(Located on the side console)  
-Typical View

### Tread Adjustment Switches

- LF (Left Front)
- LR (Left Rear)
- RF (Right Front)
- RR (Right Rear)

*NOTE: The legs may be moved in or out on each side independently.\**

3. Observe tread width on each leg.



*NOTE: The front legs use indicator decals, while the rear legs use electronic sensors and display the readings on the MD3 Monitor.*



Tread Adjust Indicator Decals  
(Front Legs)  
-Typical View



Tread Adjust Electronic Sensors  
(Rear Legs)  
-Typical View

4. Release the Tread Adjust Switch(es) when desired tread width is achieved.

*NOTE: All four tread width indicators should have identical readings after tread adjustment is complete.*

*\* When significant adjustment is being made, it is recommended that you adjust one leg at a time and perform the adjustments in smaller increments. Binding may occur if a larger adjustment is made all at once, especially if adjusting one leg at a time.*

## LADDER

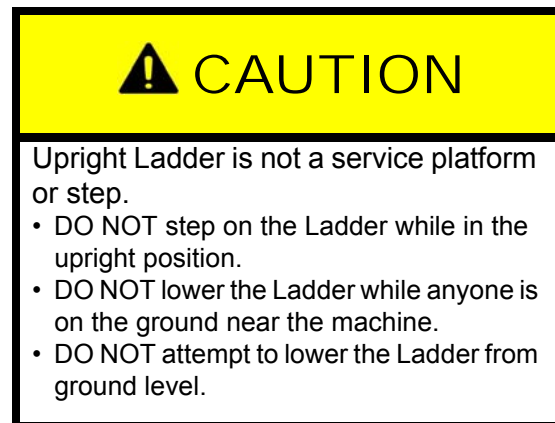

*NOTE: Bring the machine to a complete stop before engaging the Parking Brake.*

### To Lower/Raise the Ladder

- **To lower the Ladder**, press the Brake/Ladder Switch (located on the side console) in the UP (On) position.
- **To raise the Ladder**, press the Brake/Ladder Switch in the DOWN (Off) position.



Brake/Ladder Switch  
(Located on the side console)  
-Typical View

*NOTE: When the Ladder is lowered, the Parking Brake will automatically engage.*



-Typical View

---

---

## PRESSURE WASHER

### -If Equipped

*NOTE: The Parking Brake must be engaged before operating the Pressure Washer.*

## ⚠ CAUTION

Pressurized water can be abrasive. Never directly spray fragile or sensitive materials. Failure to comply may result in injury or property damage.

## NOTICE

Never use the pressure washer to spray items under the hood. Failure to comply may result in engine and other component damage and will void the warranty.

## NOTICE

Never run the pressure washer without water supply. Operating without water will cause pump failure and will void the warranty.

### To Operate the Pressure Washer

1. Ensure there is adequate amount of water in the rinse tank.
2. Ensure the Pressure Washer wand and hose (located near ladder on left-hand side of machine) are securely connected.
3. Open the Rinse Tank Supply Valve (located on the rinse tank).



Rinse Tank Supply Valve  
(Located on the rinse tank)  
-Typical View

4. Activate the Pressure Washer Pump by pressing the Pressure Washer Switch (located on the side of the fresh water tank) in the UP (On) position.



Pressure Washer Switch  
(Located on the side of the  
fresh water tank)  
-Typical View

5. The Pressure Washer is now ready for use. Extend hose as desired.



Pressure Washer Wand/  
Hose Reel Assembly  
(Located near rear of machine)  
-Typical View

6. Retract hose and turn Pressure Washer Switch OFF when finished.

## SECTION 6 – ELECTRICAL SYSTEMS

**WARNING**

**CALIFORNIA PROPOSITION  
65 WARNING**

**WARNING:** Diesel engine exhaust and some of its constituents are known to the State of California to cause cancer and birth defects or other reproductive harm.

**WARNING:** Battery posts, terminals, and related accessories contain lead and lead compounds, and chemicals known to the State of California to cause cancer and birth defects or other reproductive harm.



Battery Access  
(Located at rear of machine -  
remove panel to access)  
-Typical View

### BATTERIES

**CAUTION**

Batteries contain sulfuric acid. Avoid contact with skin, eyes, or clothing. Do not inhale fumes or ingest liquid. Batteries contain gases which can explode. Keep sparks and flame away while servicing.

**CAUTION**

Disconnect the battery when servicing any part of the electrical system. Failure to comply may result in injury and property damage.

#### Access

The Batteries are located at the rear of machine. Remove panel to access.

*NOTE: When servicing the electrical system, always remove the batteries (removing the ground cable first). When reinstalling the batteries, connect the ground cable last.*

#### Charging

**CAUTION**

Electrical system is 12 volt negative ground. When using booster with jumper cables, precautions must be taken to prevent personal injury or damage to electrical parts.

1. Attach one end of jumper cable to positive terminal of booster battery and other end to positive terminal of vehicle battery connected to starter motor.
2. Attach one end of second cable to negative terminal of booster battery and other end to vehicle frame away from battery. Do not attach to cab or cab support.
3. To remove cables, reverse above sequence exactly to avoid sparks. See operator's manual for additional information.

For your convenience, a set of Auxiliary Battery Charging Posts are located beneath the center of machine for ease of charging the batteries.



Auxiliary Battery Charging Posts  
(Located beneath center of machine)  
-Typical View

Connect your charging cables to the auxiliary battery charging posts just as you would to the battery - positive cable to the positive terminal, and negative cable to the negative terminal.

*NOTE: Keep these terminals clean and their caps in place when not in use.*

NOTICE

To ensure sufficient electrical contact, battery terminal connections should be as clean and tight as possible.

### Cleaning

- Disconnect the battery cables from the Batteries.
- Remove any corrosion with a wire brush or battery post brush.
- Wash the battery cable connections and posts with a mild baking soda and ammonia solution.
- Apply grease (or dielectric grease) to prevent corrosion.
- Reconnect the batteries, ensuring connections are tight.
- Clean every 100 hours of operation.

### Replacement

Install replacement batteries with ratings equivalent to the following specifications:

- **Voltage** - 12V only.
- **CCA** - 30 seconds at 0° F. (950).
- **Reserve Capacity** - 185 minutes at 25 amps.

### Storage

Refer to “Storage” provided in the *Maintenance and Storage Section* elsewhere in this manual for further information.

---



---

## BATTERY DISCONNECT SWITCH

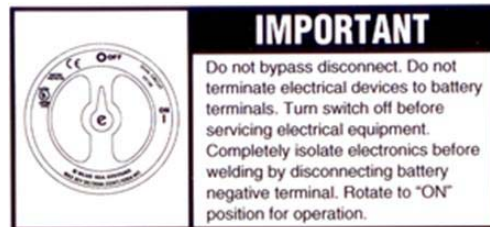

Your machine is equipped with a Battery Disconnect Switch (located beneath center of machine).

- Rotate the Battery Disconnect Switch to the ON (clockwise) or OFF (counter-clockwise) positions to operate.



Battery Disconnect Switch  
(Located beneath center of machine)  
-Typical View

# SECTION 6 – ELECTRICAL SYSTEMS



*NOTE: DO NOT use the Battery Disconnect Switch as a safety device when performing work to the electrical system. Disconnect the negative battery cable before servicing.*

## CIRCUIT BREAKERS AND FUSES

Your machine is equipped with Circuit Breakers and Fuse Panels provided in various locations.

- **(A) - Cab Functions** (located beneath the right-hand console)
- **(B and C) - Light Functions** (located beneath the cab - remove panel to access)
- **(D and F) - Modal Functions** (located beneath cab - remove panel to access)
- **(E) - Engine Functions** (located in engine compartment)

**A**

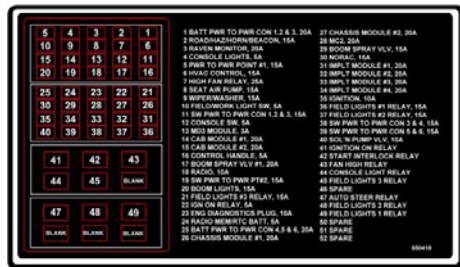

-Typical View

**B**

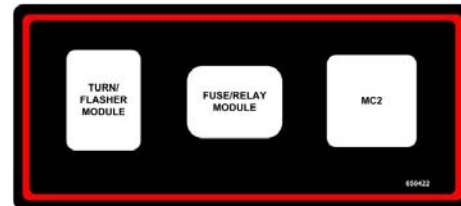
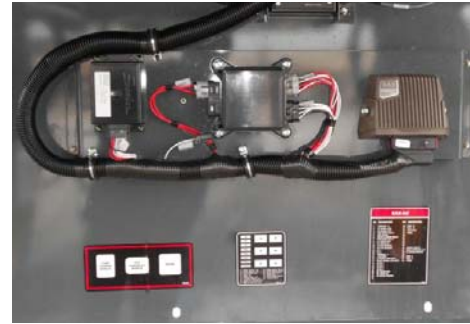

-Typical View

**C**

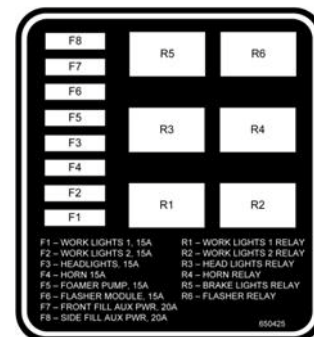
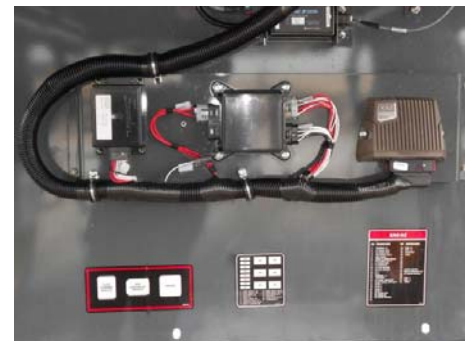

-Typical View

D



| MC2 |                      |     |                     |
|-----|----------------------|-----|---------------------|
| PIN | DESCRIPTIONS         | PIN | DESCRIPTIONS        |
| 1   |                      | 26  | J1939 CAN-H         |
| 2   | LR TREAD ADJ VLV-OUT | 27  | ICP CAN-H           |
| 3   | REACTION STEERG VLV  | 28  | +BATTERY            |
| 4   | NTB SPRAY VLV #3     | 29  | -VREF               |
| 5   | HID AUX LIGHTS RELAY | 30  | LR TREAD ADJ VLV-IN |
| 6   | MC2 RTC PWR TRNDG    | 31  | ID BIT 1            |
| 7   | RR TREAD ADJ SENSOR  | 32  | LF TREAD VLV-IN     |
| 8   | RR TREAD ADJ VLV     | 33  | DUMP AIR BAG VLV    |
| 9   | FLASHER FIELD MODE   | 34  | ID BIT 1            |
| 10  | NTB SPRAY VLV #2     | 35  | ID BIT 2            |
| 11  | RED BRAKE VLV        | 36  | RR TREAD ADJ VLV-IN |
| 12  | USB DATA +           | 37  | LR TREAD ADJ SENS   |
| 13  | USB DATA -           | 38  | PT-1 SIGNAL         |
| 14  |                      | 39  |                     |
| 15  | - BATTERY            | 40  | J1939 CAN-L         |
| 16  | LR TREAD ADJ VLV-OUT | 41  | ICP CAN-L           |
| 17  | RF TREAD VLV-OUT     | 42  | +VREF               |
| 18  | LF TREAD VLV-OUT     |     |                     |
| 19  | RF TREAD VLV-IN      |     |                     |
| 20  | ID BIT 3             |     |                     |
| 21  |                      |     |                     |
| 22  | RR TREAD ADJ VLV-OUT |     |                     |
| 23  |                      |     |                     |
| 24  | RED ACT BIT SIGNAL   |     |                     |
| 25  | PT-2 SIGNAL          |     |                     |

-Typical View

F



| XA2-A1 |                            | XA2-A0 |                           |
|--------|----------------------------|--------|---------------------------|
| PIN    | DESCRIPTIONS               | PIN    | DESCRIPTIONS              |
| 1      | ADDRESS -H                 | 1      | ADDRESS -H                |
| 2      | AUX FAN VLV SIGNAL 2       | 2      | OPT FORWARD SIGNAL        |
| 3      | LR STEERING IN/OUT         | 3      | OPT FORWARD SIGNAL        |
| 4      | RR STEERING IN/OUT         | 4      | EXHAUST BRAKE VLV SIGNAL  |
| 5      | LF WHEEL MTR SIGNAL        | 5      | BRAKE SOURCE RELAY SIGNAL |
| 6      | RF WHEEL MTR SIGNAL        | 6      | LR WHEEL MTR SIGNAL       |
| 7      |                            | 7      | RR WHEEL MTR SIGNAL       |
| 8      | DEFACELER VLV SIGNAL       | 8      | MAIN FOAMER VLV SIGNAL    |
| 9      | DUMP VLV SIGNAL            | 9      | AUX FAN VLV SIGNAL        |
| 10     | LR AMS POS SENSOR          | 10     | PT2 SENSOR SIGNAL         |
| 11     | RR AMS POS SENSOR          | 11     | PT2 SENSOR SIGNAL         |
| 12     | LR AMS PROX SENSOR         | 12     | OIL TANK TEMP SENSOR SIG  |
| 13     | RR AMS PROX SENSOR         | 13     | FUEL SENSOR SIGNAL        |
| 14     | ADDRESS -L                 | 14     | ADDRESS -L                |
| 15     | BATTERY                    | 15     | BATTERY                   |
| 16     | LR STEERING VLV OUT RET.   | 16     | OPT FORWARD SIGNAL RET.   |
| 17     | RR STEERING VLV OUT RET.   | 17     | OPT FORWARD RET.          |
| 18     | LF WHEEL MTR RET.          | 18     | OIL LEVEL SWITCH SIGNAL   |
| 19     | RF WHEEL MTR RET.          | 19     |                           |
| 20     |                            | 20     | LR WHEEL MTR RET.         |
| 21     |                            | 21     | RR WHEEL MTR RET.         |
| 22     |                            | 22     | BRAKE VLV SIGNAL          |
| 23     | LF SPEED SENSOR SIGNAL     | 23     | BACK UP ALARM SIGNAL      |
| 24     | RR SPEED SENSOR SIGNAL     | 24     | LR WHEEL SPEED SENSOR SIG |
| 25     | ICP CAN-H                  | 25     | PT2 SENSOR SIGNAL         |
| 26     |                            | 26     | ICP CAN-H                 |
| 27     | -BATTERY                   | 27     | ICP CAN-L                 |
| 28     | -VREF                      | 28     | +BATTERY                  |
| 29     |                            | 29     | -VREF                     |
| 30     | LR STEERING VLV RET.       | 30     | OPT REVERSE SIGNAL RET.   |
| 31     | RR STEERING VLV RET.       | 31     | OPT REVERSE RET.          |
| 32     |                            | 32     | PRESSURE SWITCH SIGNAL    |
| 33     |                            | 33     |                           |
| 34     |                            | 34     |                           |
| 35     |                            | 35     |                           |
| 36     | RR TREAD IN                | 36     | LEFT FOAMER VLV SIGNAL    |
| 37     | RR SPRAY NOZZLE SIGNAL     | 37     | RIGHT FOAMER VLV SIGNAL   |
| 38     | RF SPEED SENSOR SIGNAL     | 38     | RR WHEEL SPEED SENSOR SIG |
| 39     | LF CYLINDER POS SEN SIGNAL | 39     | PT2 SENSOR SIGNAL         |
| 40     | ICP CAN-L                  | 40     | ICP CAN-L                 |
| 41     |                            | 41     | ICP CAN-L                 |
| 42     | +VREF                      | 42     | -VREF                     |

-Typical View

E



|                |                          |                             |                      |             |            |            |            |            |            |
|----------------|--------------------------|-----------------------------|----------------------|-------------|------------|------------|------------|------------|------------|
| SOLENOID RELAY | INTAKE HEATER 1 SOLENOID | INTAKE HEATER 1 FUSE LOGAMP | MAIN CIRCUIT BREAKER | START RELAY | STOP RELAY | STOP RELAY | STOP RELAY | STOP RELAY | STOP RELAY |
| SOLENOID RELAY | INTAKE HEATER 2 SOLENOID | INTAKE HEATER 2 FUSE LOGAMP |                      |             |            |            |            |            |            |
| SOLENOID RELAY | INTAKE HEATER 3 SOLENOID | INTAKE HEATER 3 FUSE LOGAMP |                      |             |            |            |            |            |            |
| AIR RELAY      |                          |                             |                      |             |            |            |            |            |            |

-Typical View



## SECTION 7 – SPRAY SYSTEMS

### SPRAY BOOMS - 60/80/90/100'

#### -If Equipped

The Spray Booms are controlled by an electro-hydraulic system. This system consists of operator-manipulated switches (located on the side console and the hydrostatic drive control handle) and hydraulic cylinders (attached to the booms), which provide lift, level, horizontal extension, and vertical extension.

#### CAUTION

When operating or positioning the booms, observe the following safety precautions. Failure to comply may result in injury or equipment damage.

- Do not unfold/fold boom extensions when main boom is in cradle.
- Do not operate machine with one boom out of cradle and the other boom in cradle.
- Ensure booms are folded and in cradle before transporting the machine.

#### WARNING

When operating or positioning the booms, observe the following safety precautions:

- Monitor both sides of the boom during fold procedure.
- Cradle booms when leaving the machine unattended.
- Ensure booms are folded when cradled.
- Select a safe area before unfolding/folding the booms.
- Clear area of personnel.
- Check for overhead obstructions.
- Do not unfold/fold booms near power lines. Contact with power lines can result in serious injury or death.
- Spray equipment is designed for FIELD USE ONLY. Do not attempt to use machinery for anything other than it's intended purpose.

#### WARNING

Hydraulic and electrical control systems are optimized for use of the spray boom attachment. Any modification to these systems may lead to unintended and uncontrolled motion. DO NOT install add-on control systems that are not approved by Hagie Manufacturing Company.

### Power Lines

Hagie Manufacturing Company cannot stress enough that extreme caution must be taken when operating equipment around power lines. Ensure there is more than sufficient clearance when transporting, unfolding and folding the boom, or spraying near power lines.





As a safety precaution, a Power Line Warning Message will appear on the MD3 Monitor before operating the booms. Press “ACK” (Acknowledge) showing that you have acknowledged that there are no overhead power lines or obstructions before proceeding.



Power Line Warning Message  
(Located on the MD3 Monitor)  
-Typical View

Hydraulically folding the outer extensions of a 60/80/90-ft. or 60/100-ft. Spray Boom, adjusting the spray valves, and recalibrating the spray system console essentially turns it into a 60-ft. Spray Boom.

Manually folding the outer extensions of the 60/80/90-ft. Spray Boom, adjusting the spray valves, and recalibrating the spray system console turns it into an 80-ft. Spray Boom (see the following illustrations).

Refer to the Spray System Console calibration information provided elsewhere in this section for further information.

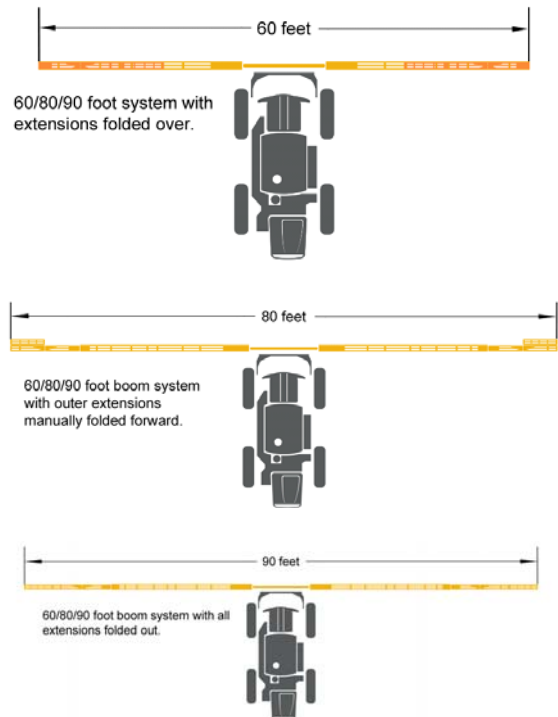

## Spray Boom Components

- (A) - Lift Cylinder
- (B) - Transom
- (C) - Main Pivot Cylinder
- (D) - Level Cylinder
- (E) - Lift Arm
- (F) - Main Boom Section
- (G) - Boom Extension Cylinder
- (H) - Boom Extension
- (I) - Boom Breakaway Cylinder





*NOTE: DO NOT lower the main lift while the boom is in the cradle.*

1. Press and hold the Left and Right Boom Switches (located on the Hydrostatic Drive Control Handle) in the UP position to raise the level cylinders all the way up.

## Hydraulic Breakaway Circuit (90 and 100-ft. Spray Booms)

90 and 100-ft. Spray Booms are equipped with a Hydraulic Breakaway Circuit. When folded out as an 80, 90, or 100-ft. Spray Boom, a one-way hydraulic circuit (located on the outer boom section) provides outer boom breakaway functions.



*NOTE: The outer breakaway is self-resetting and will return to the normal operating position after it has cleared the hazard.*

## Spray Boom Extension (Unfold)

 **CAUTION**

Booms will unfold vertically even if they are still in the boom cradle or are not horizontally extended.

*NOTE: Ensure the Hydrostatic Drive Control Handle is in the NEUTRAL position. If the machine is put in gear during fold/unfold operation, boom movement will stop.*



Left and Right Boom Switches  
(Located on the Hydrostatic  
Drive Control Handle)  
-Typical View

2. Press and hold the Left and Right Boom Switches in the OUT position to unfold the main boom sections until they come to a complete stop.
3. Lower the level cylinders until the boom is parallel with the ground.
4. Press and hold the corresponding Boom Extension Switch (located on the side console) in the UP (Out) position to unfold the left and right outer boom extensions all the way OUT.

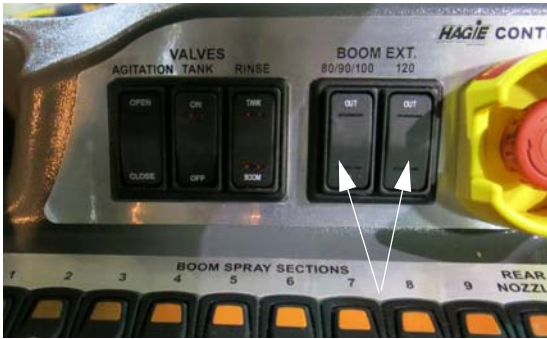

Boom Extension Switches  
(Located on the side console)  
-Typical View

### Spray Boom Retraction (Fold)

*NOTE: Ensure the Hydrostatic Drive Control Handle is in the NEUTRAL position. If the machine is put in gear during fold/unfold operation, boom movement will stop.*

1. Lower the level cylinders until the boom is parallel with the ground.
2. Press and hold the corresponding Boom Extension Switch (located on the side console) in the DOWN (In) position to fold the left and right outer boom extensions all the way IN.



Boom Extension Switches  
(Located on the side console)  
-Typical View

3. Press and hold the Left and Right Boom Switches (located on the Hydrostatic Drive Control Handle) in the UP position to raise the level cylinders all the way up.



Left and Right Boom Switches  
(Located on the Hydrostatic Drive Control Handle)  
-Typical View

4. Press and hold the Left and Right Boom Switches (located on the Hydrostatic Drive Control Handle) in the IN position until the main boom sections come to a complete stop.
5. Lower the level cylinders until the boom sections are seated in the boom cradles.

### Manual Fold (90-ft. Spray Boom to an 80-ft. Spray Boom)

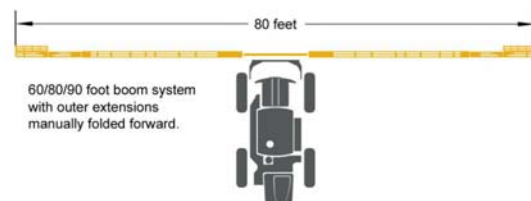

1. Close the Solution Valve (located on the outer boom section) (A).
2. Remove the bolt (located on the back side of the boom) (B), so it will hinge forward (C), and secure it with the rear bolt (D).



one field to the next. A power switch is located on the back side of the monitor.



Norac Monitor  
-Typical View

- **To Enable**, press the corresponding Auto or Manual Button (located on the main “Run Screen”) to the ON (green illuminated position).

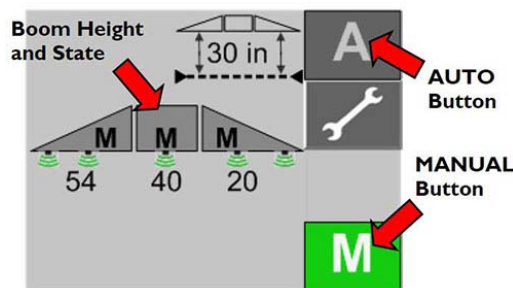

Auto/Manual Buttons - Norac  
(Located on the main “Run Screen”)  
-Typical View

*\* Your monitor may vary in appearance, depending on model*

3. Repeat Steps 1 and 2 on the opposite side and recalibrate the Spray System Console accordingly before resuming spray application.

Refer to the Spray System Console manufacturer’s operation manual for recalibrating information.

## Enabling/Disabling Norac® in the Pulse Display

**-If Equipped**

*NOTE: Hagie Manufacturing Company recommends turning the Norac Monitor OFF when traveling from*

- **To Disable**, press the corresponding Auto or Manual Button to the OFF (gray) position or press any one of the following boom control switches (located on the Hydrostatic Drive Control Handle):
  - Transom Switch (Up/Down)
  - Left or Right Boom Switch (Up/Down)

*NOTE: If the Norac System becomes inoperable, the Auto and Manual Fold functions will still operate.*

## Enabling/Disabling Norac in the Ag Leader® Display

### -If Equipped

- **To Enable**, press the Auto/Manual Button (located on the main “Run Screen”) to the ON (green illuminated position).

*NOTE: When the system is engaged, the boom image will change from black to blue.*



Auto/Manual Button - Ag Leader  
(Located on the main “Run Screen”)  
-Typical View

*\* Your monitor may vary in appearance, depending on model*

- **To Disable**, press the Auto/Manual Button to the OFF (white) position or press any one of the following boom control switches (located on the Hydrostatic Drive Control Handle):
  - Transom Switch (Up/Down)
  - Left or Right Boom Switch (Up/Down)

*NOTE: When the system is disabled, the boom image will change from blue to black.*

*NOTE: If the Norac System becomes inoperable, the Auto and Manual Fold functions will still operate.*

## Norac/Ag Leader System Settings

### -If Equipped

### (Soil/Crop Mode, Target Height, and Sensitivity)

*NOTE: Settings may be adjusted through the main Run Screen by pressing the Boom Image or the Settings Button (wrench icon), depending on model. Refer to the Norac or Ag Leader manufacturer’s operation manual for further information.*

### Soil/Crop Mode

Soil Mode allows the sensors to read the height from the spray nozzles to the ground. Crop Mode allows the sensors to read the height from the spray nozzles to the top of the crop canopy.

### On the Norac Pulse Monitor:

- Press the Settings Button (wrench icon) (located on the main “Run Screen”) to navigate to the Settings Screen.
- Press the Next Button (located next to “Mode”) and select Soil, Crop, or Hybrid Mode.

*NOTE: Hybrid Mode is an improved Crop Mode, which uses a combination of the crop and oil readings to improve control. This setting is recommended in place of Crop Mode.*

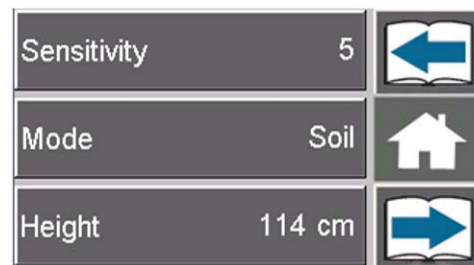

Settings Screen  
(Norac)

-Typical View

*\* Your monitor may vary in appearance, depending on model*

**On the Ag Leader Monitor:**

- Press the Boom Image (located on the main “Run Screen”).
- Press the top drop-down arrow (located on the Boom Height Control Options Screen) and select Soil or Crop Mode.

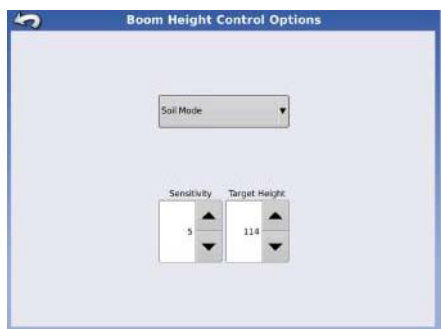

Boom Height Control Options Screen  
(Ag Leader)  
-Typical View

*\* Your monitor may vary in appearance, depending on model*

**Sensitivity**

Sensitivity is how responsive the system is. The lower the number, the lower the sensitivity. The higher the number, the higher the response time and hydraulic demand.

*NOTE: Default sensitivity setting is 5.*

**On the Norac Pulse Monitor:**

- Press the Settings Button (wrench icon) (located on the main “Run Screen”) to navigate to the Settings Screen.
- Press the Next Button (located next to “Sensitivity”) and increase or decrease system sensitivity values from 1-10.

**On the Ag Leader Monitor:**

- Press the Boom Image (located on the main “Run Screen”).
- Press the Sensitivity Buttons (located on the Boom Height Control Options Screen) and increase or decrease system sensitivity values from 1-10.

**Target Height**

Target Height is the height you desire the boom to be set at when spraying.

*NOTE: When operating in Soil Mode, the Target Height is measured from the spray nozzles to the soil. In Crop Mode, the target height is measured from the crop canopy to the spray nozzles.*

**On the Norac Pulse Monitor:**

- Press the Settings Button (wrench icon) (located on the main “Run Screen”) to navigate to the Settings Screen.
- Press the Next Button (located next to “Height”) and increase or decrease values to desired boom height.

**On the Ag Leader Monitor:**

- Press the Boom Image (located on the main “Run Screen”).
- Press the Target Height Buttons (located on the Boom Height Control Options Screen) and increase or decrease values to desired boom height.

**Further Information**

Refer to the Norac or Ag Leader manufacturer’s operation manual for complete operating/calibration instructions, troubleshooting information, and safety precautions.

---



---

**SPRAY BOOMS - 120/132'**

**-If Equipped**

The Spray Booms are controlled by an electro-hydraulic system. This system consists of operator-manipulated switches (located on the side console and the hydrostatic drive control handle) and hydraulic cylinders (attached to the booms), which provide lift, level, horizontal extension, and vertical extension.

**⚠ CAUTION**

When operating or positioning the booms, observe the following safety precautions. Failure to comply may result in injury or equipment damage.

- Do not unfold/fold boom extensions when main boom is in cradle.
- Do not operate machine with one boom out of cradle and the other boom in cradle.
- Ensure booms are folded and in cradle before transporting the machine.

**⚠ WARNING**

When operating or positioning the booms, observe the following safety precautions:

- Monitor both sides of the boom during fold procedure.
- Cradle booms when leaving the machine unattended.
- Ensure booms are folded when cradled.
- Select a safe area before unfolding/folding the booms.
- Clear area of personnel.
- Check for overhead obstructions.
- Do not unfold/fold booms near power lines. Contact with power lines can result in serious injury or death.
- Spray equipment is designed for FIELD USE ONLY. Do not attempt to use machinery for anything other than it's intended purpose.

**⚠ WARNING**

Hydraulic and electrical control systems are optimized for use of the spray boom attachment. Any modification to these systems may lead to unintended and uncontrolled motion. DO NOT install add-on control systems that are not approved by Hagie Manufacturing Company.

**Power Lines**

Hagie Manufacturing Company cannot stress enough that extreme caution must be taken when operating equipment around power lines. Ensure there is more than sufficient clearance when transporting, unfolding and folding the boom, or spraying near power lines.



As a safety precaution, a Power Line Warning Message will appear on the MD3 Monitor before operating the booms. Press “ACK” (Acknowledge) showing that you have acknowledged that there are no overhead power lines or obstructions before proceeding.



Power Line Warning Message  
(Located on the MD3 Monitor)  
-Typical View

Hydraulically folding the outer extensions of a 120 or 132-ft. Spray Boom, adjusting the spray valves, and recalibrating the spray system console essentially turns it into a 70-ft. boom. See the following diagrams for further information.

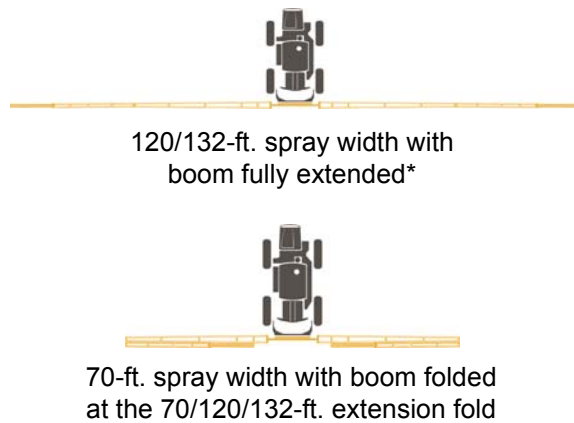

\* *Recommended spray width*

## Spray Boom Components

- Pivot Transom
- Fixed Transom
- Level Cylinders
- Roll Cylinder
- Proximity Sensors
- Norac® Sensors
- Position Sensors
- Accumulators
- Main Pivot/Breakaway Cylinders
- Outer Breakaway (Tip)

### Pivot Transom

The Pivot Transom houses work lights, solution valves, main fold cylinders, and solution plumbing.



Pivot Transom  
-Typical View

### Fixed Transom

The Fixed Transom and Lift Arm house the flow meter, lift cylinders, pressure gauge, roll lock cylinders, boom stands (if

equipped), fold control manifold, Hagie modules, Norac center sensor, and the Norac lift/level hydraulic manifold.



Fixed Transom  
-Typical View

### Level Cylinders

The Level Cylinders (located on the left and right-hand side of the transom) are responsible for the up and down movements of the boom when the level controls are activated.

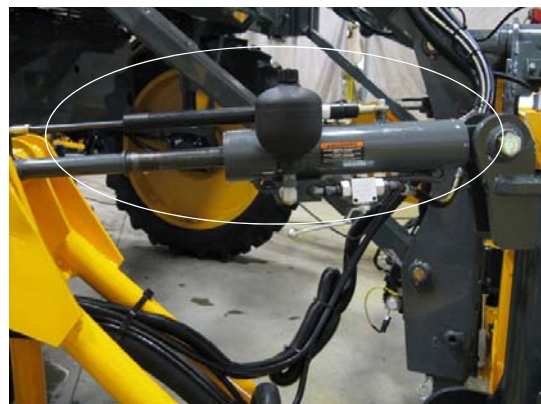

Level Cylinders  
-Typical View

### Roll Cylinder

The Roll Cylinders extend and retract to provide the “roll” functions to aid in re-centering the boom for transport.

*NOTE: The Roll Cylinders are activated automatically.*



The Roll Cylinders are automatically placed into a “passive roll state” when the main booms are in the UNFOLDED position. This means the booms will be free to move on the pendulum pieces at this point. The hydraulic valves and cylinders will not be stopping this from occurring.



Roll Cylinder  
-Typical View

### Proximity Sensors

External Proximity Sensors are located at the 70-ft. fold. The motions of the boom (folding and unfolding) are guided by the measured position of the different cylinders.

*NOTE: The Proximity Sensors are factory-positioned and should not require calibration. Contact Hagie Customer Support if boom positioning assistance is needed.*



Proximity Sensors  
-Typical View

### Norac Sensors

**CAUTION**

Placing an object beneath the Norac sensors when the system is in automatic mode may result in unintended movement.

The boom is equipped with multiple Norac Sensors that measure boom height above ground. The sensors send signals to the Norac control system allowing for position corrections to keep the boom parallel to the ground and the crop giving you a more consistent spray pattern.



Norac Sensor  
-Typical View

### Position Sensors

The level cylinders and main fold cylinders are equipped with Position Sensors. These sensors measure the linear stroke of the cylinder, allowing the boom to be positioned correctly when in Auto Fold mode.

The required specific motions exist to provide smooth, efficient operation. The programmed positions help prevent mechanical damage to the boom due to severe imbalance, unintended contact with the ground, or improper fold sequence.

*NOTE: The Position Sensors are factory-positioned and should not require calibration. Contact Hagie Customer Support if boom positioning assistance is needed.*



Position Sensor  
-Typical View

### Main Pivot/Breakaway Cylinders

The Main Pivot/Breakaway Cylinders are responsible for the horizontal extension of the booms to the spray position. They also provide breakaway protection for the boom. These breakaway cylinders will move backward to a maximum of 45-degrees in the event that the section encounters an obstacle.



Main Pivot/Breakaway Cylinders  
-Typical View

### Accumulators

**WARNING**

DO NOT remove accumulators from the transom. Failure to comply will result in catastrophic failure and will void the warranty.

The level and lift cylinders (located on the transom) are equipped with multiple Accumulators. These Accumulators act as a “shock absorber” for the booms.



Accumulator  
-Typical View



### Outer Breakaway (Tip)

A “spring” breakaway (located at the tip of the boom) moves forward and backward to provide protection of the boom by allowing the boom to fold forward or backward in the event that it were to come into contact with another object.



Boom Breakaway  
-Typical View

*NOTE: The Outer Breakaway is self-resetting and will return to the normal operating position after it has cleared the hazard.*



### Recharging Breakaway Circuit (Auto/Manual)

To recharge Breakaway Circuits in Auto/Manual Mode, press the corresponding Left or Right Boom Switch (Horizontal Extension) located on the Hydrostatic Drive Control Handle.

*NOTE: Right Extend OUT will recharge the breakaway circuits on the right-hand side of the boom. Left Extend OUT will recharge the breakaway circuits on the left-hand side of the boom.*

### Auto Fold

The Auto Fold feature is the preferred method for unfolding/folding the spray boom and makes operation of the machine easier for the operator.

*NOTE: Ensure the Hydrostatic Drive Control Handle is in the NEUTRAL position. If the machine is put in gear during fold/unfold operation, boom movement will stop.*

1. Press the F1 Switch (located on the MD3 Monitor - Misc Page) and change boom state to AUTO.



F1 Switch - Boom State  
(Located on the MD3 Monitor - Misc Page)  
-Typical View

When the boom state reads AUTO, the boom will operate with the Auto Fold Switches (located on the side console).

2. Press and hold **both** Auto Fold Switches (located on the side console) in the UP (Out) position to unfold the boom to the fully extended position on all sections.



Auto Fold Switches  
(Located on the side console)  
-Typical View

3. Press and hold **both** Auto Fold Switches (located on the side console) in the DOWN (In) position to fold the boom in to the fully retracted position.

### Spray Width

- Press the F4 Switch (located on the MD3 Monitor - Misc Page) and select desired spray width (maximum auto-fold width of the boom).



F4 Switch - Spray Width  
(Located on the MD3 Monitor - Misc Page)  
-Typical View

2. Press and hold the Left and Right Boom Switches (located on the Hydrostatic Drive Control Handle) in the UP position to raise the level cylinders all the way up.



Left and Right Boom Switches  
(Located on the Hydrostatic Drive Control Handle)  
-Typical View

## Manual Unfold (OUT)

NOTICE

Do not lower the main lift while the boom is in cradle. Failure to comply will result in property damage.

*NOTE: Ensure the Hydrostatic Drive Control Handle is in the NEUTRAL position. If the machine is put in gear during fold/unfold operation, boom movement will stop.*

1. Press the F1 Switch (located on the MD3 Monitor - Misc Page) and change boom state to MANUAL.



F1 Switch - Boom State  
(Located on the MD3 Monitor - Misc Page)  
-Typical View

3. Press and hold the Left and Right Boom Switches in the OUT position to unfold the main boom sections until they come to a complete stop.

*NOTE: Unfold booms simultaneously to prevent weight imbalance.*

4. Lower the level cylinders until the boom is parallel with the ground.
5. Press and hold the Left and Right Boom Fold Switches (located on the side console) in the UP (Out) position to unfold the outer boom extensions all the way OUT.



Boom Fold Switches  
(Located on the side console)  
-Typical View



Boom Fold Switches  
(Located on the side console)  
-Typical View

## Manual Fold (IN)

*NOTE: Ensure the Hydrostatic Drive Control Handle is in the NEUTRAL position. If the machine is put in gear during fold/unfold operation, boom movement will stop.*

1. Press the F1 Switch (located on the MD3 Monitor - Misc Page) and change boom state to MANUAL.



F1 Switch - Boom State  
(Located on the MD3 Monitor - Misc Page)  
-Typical View

2. Lower the level cylinders until the boom is parallel with the ground.
3. Press and hold the Left and Right Boom Fold Switches (located on the side console) in the DOWN (In) position to fold the outer boom extensions all the way IN.

4. Press and hold the Left and Right Boom Switches (located on the Hydrostatic Drive Control Handle) in the UP position to raise the level cylinders all the way up.



Left and Right Boom Switches  
(Located on the Hydrostatic Drive Control Handle)  
-Typical View

5. Press and hold the Left and Right Boom Switches in the IN position until the main boom sections come to a complete stop.

*NOTE: Fold booms simultaneously to prevent weight imbalance.*

6. Lower the level cylinders until the boom sections are seated in the boom cradles.

## Rolling Boom

The Rolling Boom feature will enable the boom to roll either “clockwise” or “counter-clockwise” (as viewed from the cab) using the Roll Command Switches (located on the MD3 Monitor).

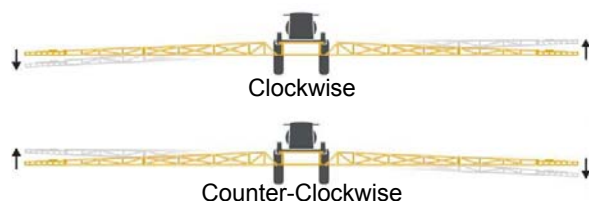

- Press and hold the F2 Switch (located on the MD3 Monitor - Misc Page) to roll the boom “clockwise”.
- Press and hold the F3 Switch to roll the boom “counter-clockwise”.
- When either the F2 or F3 Switches are released, the boom will return to the Neutral position.



F2/F3 Switches - Roll Command  
(Located on the MD3 Monitor - Misc Page)  
-Typical View

**NOTE:** The MD3 Monitor will display “True” when the desired Roll Command Switch is pressed, and will display “False” when the switch is released.

## 120/132-ft. Spray Boom Page (MD3 Monitor)

Machines equipped with 120/132-ft. spray booms are featured with specific MD3 Monitor information that allows more feedback to the operator to aid in achieving functions required for certain operations.

- A green indicator light (located on the MD3 Monitor - Home Page) will alert the operator when the boom is unfolded (out), the breakaway function is set, and the boom is ready for operation.



Spray Boom Indicator Light  
(Located on the MD3 Monitor - Home Page)  
-Typical View

If the indicator light is not illuminated, a breakaway situation has occurred. Observe the boom to determine breakaway location, then press the corresponding Left or Right Boom Switch (located on the Hydrostatic Controller) OUT.

**NOTE:** When in Auto mode, Right Extend OUT will recharge the breakaway circuit on the right-hand side of boom, and Left Extend OUT will recharge the breakaway circuit on the left-hand side of boom. Activate each individual OUT direction to recharge breakaway circuits in Manual mode.

- Status of Norac® communication, changing the boom state, roll commands, and boom spray width are located on the MD3 Monitor - Misc Page.



MD3 Monitor - Misc Page  
-Typical View

*NOTE: If “N-Add” or “A-80” are displayed on the Misc Page, the Norac System is communicating with the machine correctly.  
If “N-Add” and “0” are displayed, communication is incorrect. Refer to the Norac manufacturer’s operation manual for further information.*

## Enabling/Disabling Norac® in the Pulse Display

### -If Equipped

*NOTE: Hagie Manufacturing Company recommends turning the Norac Monitor OFF when traveling from one field to the next. A power switch is located on the back side of the monitor.*



Norac Monitor  
-Typical View

- **To Enable**, press the corresponding Auto or Manual Button (located on the

main “Run Screen”) to the ON (green illuminated position).

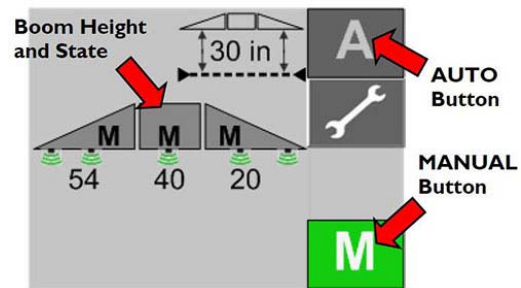

Auto/Manual Buttons - Norac  
(Located on the main “Run Screen”)  
-Typical View

*\* Your monitor may vary in appearance, depending on model*

- **To Disable**, press the corresponding Auto or Manual Button to the OFF (gray) position or press any one of the following boom control switches (located on the Hydrostatic Drive Control Handle):
  - Transom Switch (Up/Down)
  - Left or Right Boom Switch (Up/Down)

*NOTE: If the Norac System becomes inoperable, the Auto and Manual Fold functions will still operate.*

## Enabling/Disabling Norac in the Ag Leader® Display

### -If Equipped

- **To Enable**, press the Auto/Manual Button (located on the main “Run Screen”) to the ON (green illuminated position).

*NOTE: When the system is engaged, the boom image will change from black to blue.*



Auto/Manual Button - Ag Leader  
(Located on the main “Run Screen”)  
-Typical View

*\* Your monitor may vary in appearance, depending on model*

- **To Disable**, press the Auto/Manual Button to the OFF (white) position or press any one of the following boom control switches (located on the Hydrostatic Drive Control Handle):
  - Transom Switch (Up/Down)
  - Left or Right Boom Switch (Up/Down)

*NOTE: When the system is disabled, the boom image will change from blue to black.*

*NOTE: If the Norac System becomes inoperable, the Auto and Manual Fold functions will still operate.*

## Norac/Ag Leader System Settings

**-If Equipped  
(Soil/Crop Mode, Target Height, and Sensitivity)**

*NOTE: Settings may be adjusted through the main Run Screen by pressing the Boom Image or the Settings Button (wrench icon), depending on model. Refer to the Norac or Ag Leader manufacturer’s operation manual for further information.*

## Soil/Crop Mode

Soil Mode allows the sensors to read the height from the spray nozzles to the ground. Crop Mode allows the sensors to read the height from the spray nozzles to the top of the crop canopy.

### On the Norac Pulse Monitor:

- Press the Settings Button (wrench icon) (located on the main “Run Screen”) to navigate to the Settings Screen.
- Press the Next Button (located next to “Mode”) and select Soil, Crop, or Hybrid Mode.

*NOTE: Hybrid Mode is an improved Crop Mode, which uses a combination of the crop and oil readings to improve control. This setting is recommended in place of Crop Mode.*

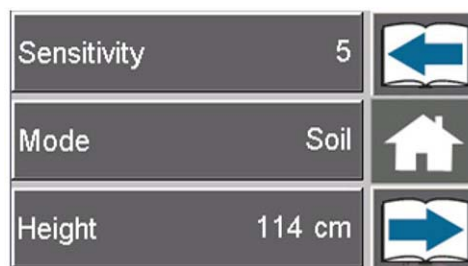

Settings Screen  
(Norac)

-Typical View

*\* Your monitor may vary in appearance, depending on model*

### On the Ag Leader Monitor:

- Press the Boom Image (located on the main “Run Screen”).
- Press the top drop-down arrow (located on the Boom Height Control Options Screen) and select Soil or Crop Mode.



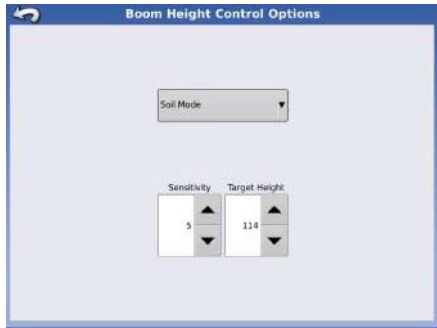

Boom Height Control Options Screen  
 (Ag Leader)  
 -Typical View

*\* Your monitor may vary in appearance, depending on model*

### Sensitivity

Sensitivity is how responsive the system is. The lower the number, the lower the sensitivity. The higher the number, the higher the response time and hydraulic demand.

*NOTE: Default sensitivity setting is 5.*

#### On the Norac Pulse Monitor:

- Press the Settings Button (wrench icon) (located on the main “Run Screen”) to navigate to the Settings Screen.
- Press the Next Button (located next to “Sensitivity”) and increase or decrease system sensitivity values from 1-10.

#### On the Ag Leader Monitor:

- Press the Boom Image (located on the main “Run Screen”).
- Press the Sensitivity Buttons (located on the Boom Height Control Options Screen) and increase or decrease system sensitivity values from 1-10.

### Target Height

Target Height is the height you desire the boom to be set at when spraying.

*NOTE: When operating in Soil Mode, the Target Height is measured from the spray nozzles to the soil. In Crop Mode, the target height is measured from the crop canopy to the spray nozzles.*

#### On the Norac Pulse Monitor:

- Press the Settings Button (wrench icon) (located on the main “Run Screen”) to navigate to the Settings Screen.
- Press the Next Button (located next to “Height”) and increase or decrease values to desired boom height.

#### On the Ag Leader Monitor:

- Press the Boom Image (located on the main “Run Screen”).
- Press the Target Height Buttons (located on the Boom Height Control Options Screen) and increase or decrease values to desired boom height.

### Further Information

Refer to the Norac or Ag Leader manufacturer’s operation manual for complete operating/calibration instructions, troubleshooting information, and safety precautions.

## SPRAY BOOM - REAR

### -If Equipped

*NOTE: The Rear Spray Boom is controlled through the center spray section of the front boom.*

### Installing the Rear Boom

1. Route solution line from the front boom to the rear boom.
2. Rotate the 3-Way Boom Valve (located on the center spray section of the front boom) to the VERTICAL position (A), to route solution flow to the Rear Spray Boom.



-Typical View

- Slide the Rear Spray Boom (B) into the Boom Mounting Brackets (C), located on each side of the rear bumper.



-Typical View

- Bolt the Rear Spray Boom onto the Boom Mounting Brackets by sliding the mounting hardware (D) inside the boom tubing and bolting through the wall of the boom.

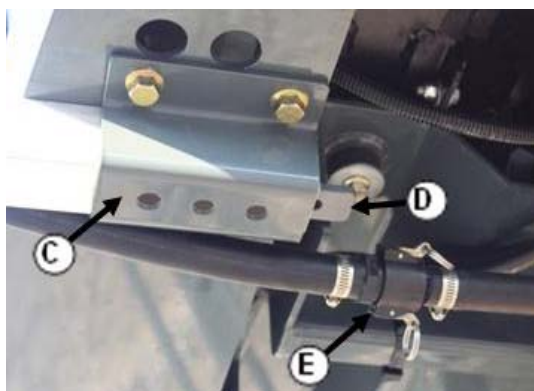

-Typical View

- Connect the solution line with the quick-connect fittings (located near the rear bumper on the lower right-hand side of the boom) (E).
- The Rear Spray Boom is now ready for use.

### Removing the Rear Boom

- Disconnect the solution line from the quick-connect fittings (E).
- Unbolt the Rear Spray Boom (B) from the Boom Mounting Brackets (C).
- Remove the Rear Spray Boom and set aside.
- Route and reconnect solution line to the front boom.
- Rotate the 3-Way Boom Valve to the HORIZONTAL position to route solution flow to the front boom.

---



---

## SOLUTION SYSTEM COMPONENTS

The Solution System is a constantly monitored, continuously adjusted computer-controlled system. The cab-mounted digital spray system console receives information from various inputs to help determine GPM (gallons per minute) and GPA (gallons per acre).

Please read and understand the information provided in this manual, as well as the spray system console manufacturer's operation manual before operating the Solution System. The following information refers to components of the Solution System and is not intended to replace the manufacturer's operating instructions.

- Solution Tank
- Solution Pump
- Flow Meter
- Pressure Gauge
- Solution Control Valves
- Solution Tank Valve
- Sump Valve
- Solution Pump Switch

- Tank Valve Switch
- Agitation Valve Switch
- Boom Solution Valve Switches
- Boom Solution Valve Indicators
- Master Spray Switch
- Spray System Console

### Solution Tank



Solution Tank  
-Typical View

### Solution Pump

The Solution Pump is a centrifugal-type hydraulic pump that is controlled by the Pulse Width Modulated Valve and the Spray System Console.



Solution Pump  
-Typical View



Pulse Width  
Modulated Valve  
-Typical View

The Solution Pump draws solution out of the tank at the rate determined during calibration. It dispenses solution through the many valves and hoses that make up the Spray System. The Solution Pump also dispenses fluids through the Agitation and Rinse Systems.

Refer to the Spray System Console manufacturer's operation manual for further information on solution pump control.

### Flow Meter

The Flow Meter (located in the main solution line) monitors the solution flow and sends information back to the Spray System Console.

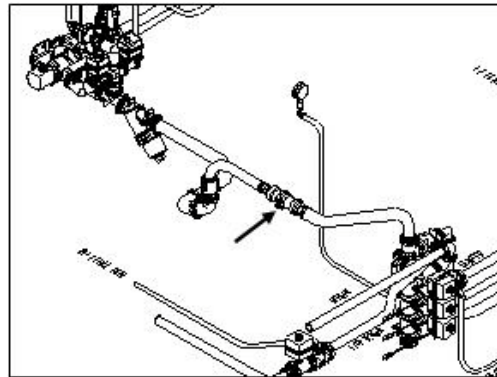

Flow Meter  
-Typical View

Refer to the Spray System Console manufacturer's operation manual for further information on low flow limits.

### Pressure Gauge

The Pressure Gauge (mounted on the boom) gives a constant visual display of solution pressure being applied (measured in PSI).

*NOTE: Pressure will vary according to speed, application, rate, tip size, etc.*



Pressure Gauge  
-Typical View

### Solution Tank Valve

The Solution Tank Valve (located beneath the solution tank on underside of machine) controls the amount of solution coming out of the tank. The Solution Tank Valve is controlled by the Tank Valve Switch (located on the side console).

### Sump Valve

The Sump Valve (located beneath the solution tank) is a ball-type valve that allows fluid into the tank from the fill option and is turned on/off manually.



Solution Tank and Sump Valves  
(Located beneath the solution tank)  
-Typical View

\* View looking toward front of machine

### Solution Pump Switch

The Solution Pump Switch (located on the side console) is used to turn on/off the Solution Pump. **This is the ONLY way to turn on/off the Solution Pump.**

*NOTE: Leaving the Solution Pump Switch in the ON position will cause the pump to run continuously, which may result in system damage.*

- Press the Solution Pump Switch in the UP position to turn ON.
- Press the Solution Pump Switch in the DOWN position to turn OFF.



Solution Pump Switch  
(Located on the side console)  
-Typical View

### Tank Valve Switch

The Tank Valve Switch (located on the side console) controls the Solution Tank Valve.

- Press Tank Valve Switch UP to open. Press switch DOWN to close.



Tank Valve Switch  
(Located on the side console)  
-Typical View

### Agitation Valve Switch

The flow rate of the Agitation System is controlled by a Variable Flow Solution Valve (located near the solution pump) to thoroughly mix solution in the tank.

Increase or decrease agitation flow by operating the Agitation Valve Switch (located on the side console).



Variable Flow Solution Valve  
(Located near the solution pump)  
-Typical View

The Agitation Valve Switch (located on the side console) controls the rate of flow through the Agitation System.



Agitation Valve Switch  
(Located on the side console)  
-Typical View

- **To increase flow**, press and hold the Agitation Valve Switch in the UP position.
- **To decrease flow**, press and hold the Agitation Valve Switch in the DOWN position.
- Release the Agitation Valve Switch when desired rate of flow is achieved.
- To turn the Agitation System OFF, decrease the flow rate all the way down.

### Boom Solution Valve Switches

The Spray Booms are divided into sections that are independently supplied with solution and can be turned on or off individually. The electrically-operated Boom

Solution Valves are controlled by the Boom Solution Valve Switches (located on the side console).

- Press Boom Solution Valve Switch UP to turn ON.
- Press Boom Solution Valve Switch DOWN to turn OFF.



Boom Solution Valve Switches  
(Located on the side console)  
-Typical View

*NOTE: 60-ft. booms are divided into five (5) sections and 80/90/100/120/132-ft. booms are divided into nine (9) sections.*

### Boom Solution Valve Indicators

Your machine is equipped with Boom Solution Valve Indicators (located on the cab headliner), which allow you to view system status for the following:

- (1) Master Spray Indicator (illuminates when ON).
- (2) Fence Row Indicators (illuminate when ON).
- (1) Rear Wheel Nozzle (illuminates when ON).
- (9) Spray Section Indicators (illuminate when OFF).



- Left Fence Row
- Spray Section
- Rear Wheel Nozzle
- Right Fence Row
- Master Spray

Boom Solution Valve Indicators  
(Located on cab headliner)  
-Typical View

### Master Spray Switch

Main solution power and Boom Solution Valve Switches are controlled by the Master Spray Switch (located on the Hydrostatic Drive Control Handle) and must be ON to supply power.

This allows you to turn all of the Boom Solution Valves on or off at the same time, such as turning them off when you reach the end rows, and turning them back on when you re-enter the field.



Master Spray Switch  
(Located on the Hydrostatic Drive Control Handle)  
-Typical View

### Spray System Console

Refer to the Spray System Console manufacturer's operation manual for complete calibration and operating instructions.



Spray System Console  
-Typical View

*(The Spray System Console on your machine may vary according to model and available equipment)*

---



---

## SOLUTION SYSTEM - OPERATION

### NOTICE

The Solution System has been tested using RV-type antifreeze. Fill solution tank with fresh water and drain before initial use.

### NOTICE

Never attempt to operate the Spray System without solution in the tank. Failure to comply will cause severe equipment damage and will void the warranty.

## Getting Started

1. Calibrate the Spray System Console (refer to the manufacturer’s operation manual for calibration instructions).
2. Ensure there is adequate amount of solution in the tank.
3. Engage the parking brake.
4. Start the engine.
5. Press the Solution Pump Switch (located on the side console) in the UP (On) position.

### NOTICE

Do not allow the Solution Pump to run continuously while the Boom Solution Valve Switches are off. Failure to comply will generate overheating, causing severe pump damage and will void the warranty.



Solution Pump Switch  
(Located on the side console)  
-Typical View

6. Press the Tank Valve Switch (located on the side console) in the UP (Open) position.  
If desired, activate the Agitation Valve Switch (located on the side console). Press and hold switch UP to increase flow, or DOWN to decrease flow.



Tank and Agitation Valve Switches  
(Located on the side console)  
-Typical View

7. Press the F1 Switch (located on the MD3 Monitor - Home Page) and change the machine’s drive state to FIELD.



F1 (Drive State) Switch  
(Located on the MD3 Monitor)  
-Typical View

8. Turn the Master Spray Switch (located on the Hydrostatic Drive Control Handle) ON.



Master Spray Switch  
(Located on the Hydrostatic  
Drive Control Handle)  
-Typical View

9. Press the individual Boom Solution Valve Switches (located on the side console) to the ON position.



Boom Solution Valve Switches  
(Located on the side console)  
-Typical View

10. Slowly move the Hydrostatic Drive Control Handle forward to obtain desired ground speed.
11. Frequently observe the pressure gauge. If the pressure drops to zero or the spray pattern deteriorates, turn OFF the Master Spray, Solution Pump, Tank Valve, and Agitation Valve Switches until solution is refilled.

## FILLING YOUR SOLUTION TANK

### WARNING

**CHEMICALS ARE DANGEROUS**  
Read the chemical manufacturer's labels to avoid injury or damage.

### CAUTION

Wear the appropriate clothing and Personal Protective Equipment (PPE) when working with agricultural chemicals. Do not store chemical-soaked clothing inside the cab.

## Front Fill

### Filling the Solution Tank

1. Ensure the Sump Valve (located beneath the solution tank) is OPEN.



Sump Valve  
(Located beneath the solution tank)  
-Typical View

2. Pull the Front Fill Release Lever (located beneath front end of machine) OUT (to the right) to unlock the Front Fill Assembly.



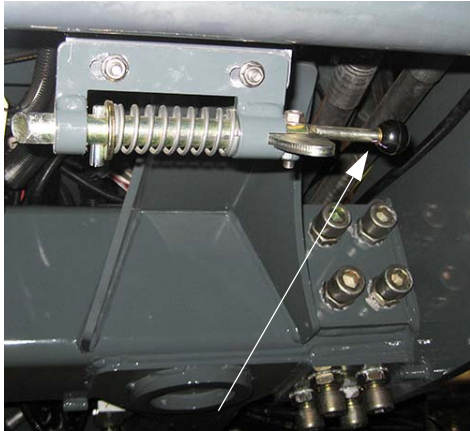

Front Fill Release Lever  
(Located beneath front end of machine)  
-Typical View

3. Lower the Front Fill Assembly.

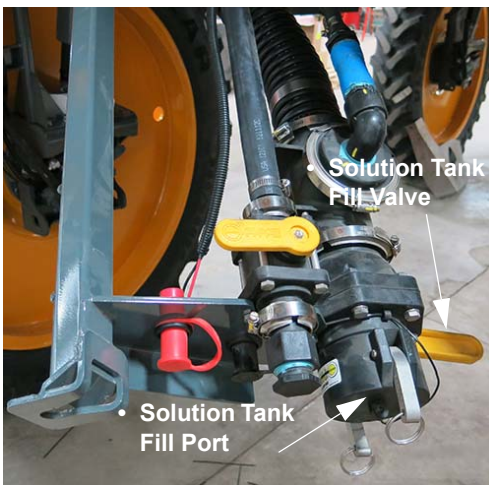

Front Fill Assembly  
(Lowered position shown)  
-Typical View

4. Remove fill port cap and connect solution supply to the Solution Tank Fill Port.
5. Rotate Solution Tank Fill Valve to the OPEN position and fill tank to desired level.

*NOTE: Two power ports (located near the front fill assembly) are provided for chemical pump connection.*

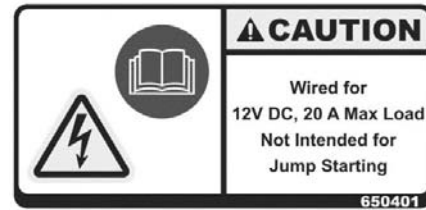

Power Ports  
(Located near front fill assembly)  
-Typical View

6. **When finished filling the tank**, close the Solution Tank Fill Valve.
7. Remove solution supply from the Solution Tank Fill Port.
8. Reinstall fill port cap.
9. Raise the Front Fill Assembly to stored position, ensuring it “clicks” into locked position.
10. Close Sump Valve.

### Filling the Rinse Tank

You may fill the Rinse Tank from ground level with an operator-supplied connection.



Rinse Tank  
-Typical View

1. Pull the Front Fill Release Lever (located beneath front end of machine) OUT (to

the right) to unlock the Front Fill Assembly.



Front Fill Release Lever  
(Located beneath front end of machine)  
-Typical View

2. Lower the Front Fill Assembly.

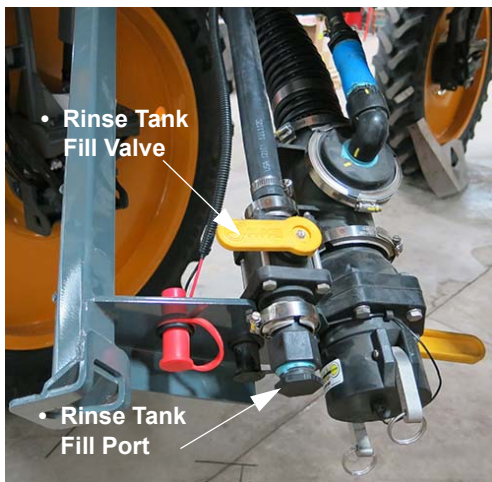

Front Fill Assembly  
(Lowered position shown)  
-Typical View

3. Remove fill port cap from the Rinse Tank Fill Port.
4. Connect operator-supplied connection to the Rinse Tank Fill Port.
5. Rotate Rinse Tank Fill Valve to the OPEN position and fill tank to desired level.
6. **When finished filling the tank**, close the Rinse Tank Fill Valve.
7. Remove operator-supplied connection from the Rinse Tank Fill Port.
8. Reinstall the fill port cap.

9. Raise the Front Fill Assembly to the stored position, ensuring it “clicks” into locked position.

## Side Fill

*NOTE: The Parking Brake must be engaged to operate the Side Fill.*

## Filling the Solution Tank (Inductor Operation)

### Inductor Assembly Components

- (A) - Rinse Supply Valve
- (B) - Fill Port
- (C) - Fill Valve
- (D) - Transfer Pump
- (E) - Chemical Inductor
- (F) - Chemical Inductor Rinse Valve
- (G) - Chemical Inductor Tank
- (H) - Side Fill Valve
- (I) - Side Fill Rinse Valve
- (J) - Swirl Valve
- (K) - Pump Power Switch
- (L) - Raise/Lower Switch
- (M) - Lock Switch
- (N) - Power Ports

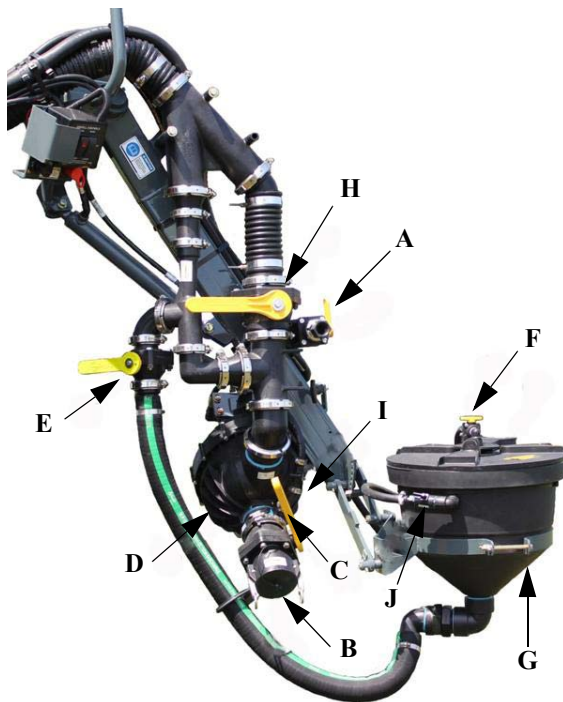

Inductor Assembly  
-Typical View

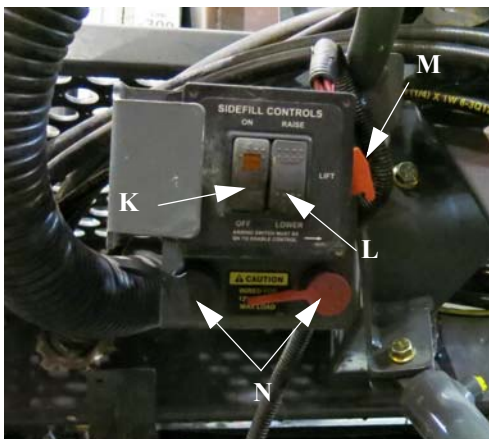

Side Fill Control Panel  
-Typical View

*NOTE: Two power ports (located beneath the Side Fill Control Panel) are provided for chemical pump connection.*

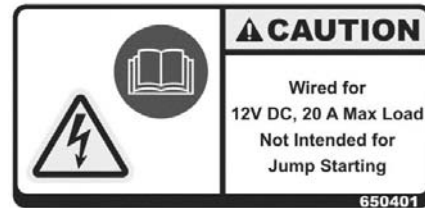

1. Engage the Parking Brake.
2. Start the engine.
3. Ensure the Sump Valve (located beneath the solution tank) is OPEN.



Sump Valve  
(Located beneath the solution tank)  
-Typical View

*\* View looking toward front of machine*

4. Lower the Inductor Assembly by pressing the Raise/Lower Switch (L) in the DOWN (Lower) position.
5. Pull the Lock Switch (M) UP.
6. Press the Pump Power Switch (K) in the UP (On) position to activate the Transfer Pump.

*NOTE: Whether filling with the Transfer Pump or an off-site pump, ensure the Transfer Pump is running.*

7. Press the Pump Power Switch DOWN (Off) when filling is complete.
8. Push the Lock Switch DOWN.

*NOTE: The following procedures are the same for either a sprayer-mounted Transfer Pump or a Nurse Tank Pump.*

**Fill Water Only**

- Fill Port (B) - **CONNECTED**
- Fill Valve (C) - **OPEN**
- Chemical Inductor (E) - **CLOSED**

- Chemical Inductor Rinse Valve (F) - *CLOSED*
- Side Fill Valve (H) - *OPEN*
- Swirl Valve (J) - *CLOSED*

#### **Fill Water/Induct Chemical**

- Fill Port (B) - *CONNECTED*
- Fill Valve (C) - *OPEN*
- Side Fill Valve (H) - *CLOSED*
- Chemical Inductor (E) - *OPEN* (after flow is established)

#### **Fill Water/Induct Dry Chemical**

- Fill Port (B) - *CONNECTED*
- Fill Valve (C) - *OPEN*
- Side Fill Valve (H) - *CLOSED*
- Swirl Valve (J) - *OPEN*

*NOTE: Allow water to fill chemical tank approximately 3 inches (7.6 cm) before adding dry chemical. Add dry chemical with the Side Fill Rinse Valve (I) OPEN. Open the Chemical Inductor (E) after dry chemical has been added.*

#### **Fill Rinse Tank**

- Rinse Supply Valve (A) - *OPEN*

#### **Rinse Inductor Tank**

- Chemical Inductor Rinse Valve (F) - *OPEN*

*NOTE: Before raising the Inductor Assembly, the Chemical Inductor Tank must be in the LOCKED position.*

#### **Rinsing the Side Fill**

1. Turn the Side Fill Rinse Valve (I) to the OPEN position.
2. Turn the Side Fill Valve (H) to the OPEN position.
3. Press the Tank Valve Switch (located on the side console) in the DOWN (Off) position.
4. Press the Rinse Switch (located on the side console) in the UP (Tank) position.
5. Turn the Solution Pump Switch (located on the side console) in the UP (On) position.

*NOTE: Close the Side Fill Rinse Valve (I) when rinsing is complete. Failure to comply will cause the Side Fill to not function properly when filling.*

## RINSE SYSTEM

Operate the Rinse System on your machine to flush the spray system (solution tank, fill lines, booms, nozzles, and solution pump).

*NOTE: Ensure the solution tank is empty before activating the Rinse System.*

### NOTICE

Select a safe area to rinse the spray system and clean the sprayer where chemicals will not drift off to contaminate people, animals, vegetation, or water supply.

Refer to the chemical manufacturer's information for types of cleaning solution combinations (water, cleaning agents, etc.)

### Step 1 - Rinsing the Solution Tank and Fill Lines (Front Fill and Side Fill)

1. Open the Side Fill Rinse Valve (I - shown on previous page).
2. Press the Solution Pump Switch (located on the side console) in the UP (On) position.



Solution Pump Switch  
(Located on the side console)  
-Typical View

3. Turn the Spray System Console ON.

4. Press the Auto/Manual Switch (located on the Spray System Console) to the MANUAL position.
5. Press the Flow Increase/Decrease Switch (located on the Spray System Console) and increase solution pressure to desired PSI (bar).
6. Press the Tank Valve Switch (located on the side console) in the DOWN (Close) position.



Tank Valve Switch  
(Located on the side console)  
-Typical View

7. Press the Rinse Switch (located on the side console) in the UP (Tank) position.



Rinse Switch  
(Located on the side console)  
-Typical View

8. When finished rinsing the solution tank, press the Rinse Switch to the OFF (mid) position.

## Step 2 - Rinsing the Boom and Nozzles

1. Press the Solution Pump Switch (located on the side console) in the UP (On) position.



Solution Pump Switch  
(Located on the side console)  
-Typical View

2. Turn the Spray System Console ON.
3. Press the Auto/Manual Switch (located on the Spray System Console) to the MANUAL position.
4. Press the Flow Increase/Decrease Switch (located on the Spray System Console) and increase solution pressure to desired PSI (bar).
5. Press the Agitation Valve Switch (located on the side console) in the DOWN (Off) position.



Agitation Valve Switch  
(Located on the side console)  
-Typical View

- Press the Tank Valve Switch (located on the side console) in the DOWN (Close) position.



Tank Valve Switch  
(Located on the side console)  
-Typical View

- Press the Boom Solution Valve Switches (located on the side console) in the UP (On) position.



Boom Solution Valve Switches  
(Located on the side console)  
-Typical View

- Press the Rinse Switch (located on the side console) in the DOWN (Boom) position to rinse the boom and nozzles.



Rinse Switch  
(Located on the side console)  
-Typical View

- When rinsing is complete, press the Rinse Switch in the OFF (mid) position.

*NOTE: Also ensure the Spray System is OFF (including the Spray System Console, Solution Pump Switch, Boom Solution Valve Switches, and the Master Spray Switch, etc.)*

---



---

## FENCE ROW APPLICATOR

### To Operate the Fence Row Nozzles

- Press the Fence Row Switch (located on the side console) in the UP position to apply solution from the RIGHT side of machine.
- Press the Fence Row Switch in the DOWN position to apply solution from the LEFT side of machine.
- Place Fence Row Switch in the mid (center) position to turn OFF.

*NOTE: The corresponding Fence Row indicator will illuminate on the Boom Solution Valve Indicator display when active.*



Fence Row Switch  
(Located on the side console)  
-Typical View

*NOTE: When the Fence Row Switch is activated, you may notice a drop in solution pressure.*

### To Operate the Rear Nozzles

The Rear Nozzle Switch (located on the side console) controls the two (2) rear nozzles (located behind the tires).

- Press the Rear Nozzle Switch in the UP (On) position to activate.

*NOTE: The Rear Nozzle indicator will illuminate on the Boom Solution Valve Indicator display when active.*



Rear Nozzle Switch  
(Located on the side console)  
-Typical View

*NOTE: When the Rear Nozzle Switch is activated, you may notice a drop in solution pressure.*

## FOAM MARKER SYSTEM

- If Equipped

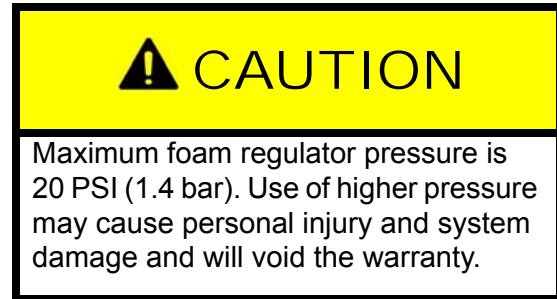

### Foam Marker Operation

1. Open Foam Marker Hand Valve (located near the rear of Rinse Tank).
  - Turn valve “clockwise” to open.
  - Turn valve “counter-clockwise” to close.



Foam Marker Hand Valve  
(Located near the rear of Rinse Tank)  
-Typical View

2. Locate the Foam Marker Switch (located on top of the Hydrostatic Drive Control Handle).
  - Press Foam Marker Switch LEFT to apply foam from the left foam drop.
  - Press Foam Marker Switch RIGHT to apply foam from the right foam drop.

Left Foam Right Foam



Foam Marker Switch  
(Located on the Hydrostatic  
Drive Control Handle)  
-Typical View

3. Observe system pressure indicated on the Foam Marker Pressure Gauge (located on the side of the fill tank).



Foam Marker Pressure Gauge  
(Located on the side of the fill tank)  
-Typical View



Foam Pressure Dial  
(Located on the side of the fill tank)  
-Typical View

## Setting the Foam Marker

### (Foam Frequency and Concentration)

- Turn Foam Frequency Dial (located on the side of the fill tank) to adjust the foam frequency. Turn dial “clockwise” to INCREASE frequency. Turn dial “counter-clockwise” to DECREASE frequency.
- Turn Foam Concentration Dial (located on the side of the fill tank) to adjust the foam concentration level. Turn dial “clockwise” to INCREASE concentration. Turn dial “counter-clockwise” to DECREASE foam concentration.

## Pressure Adjustment

- Turn Foam Pressure Dial (located on the side of the fill tank) to adjust air pressure in the tank. Turn dial “clockwise” to INCREASE pressure. Turn dial “counter-clockwise” to DECREASE pressure.



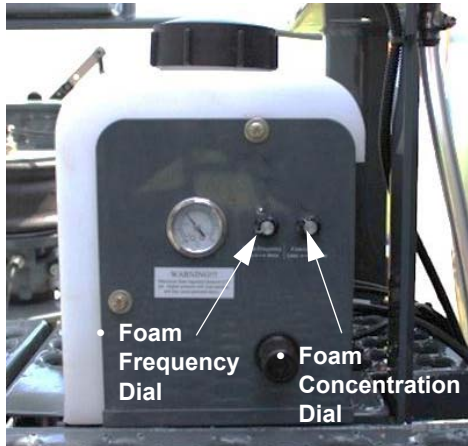

Foam Frequency and  
Concentration Dials  
(Located on the side of the fill tank)  
-Typical View

## Foam Drop Configurations

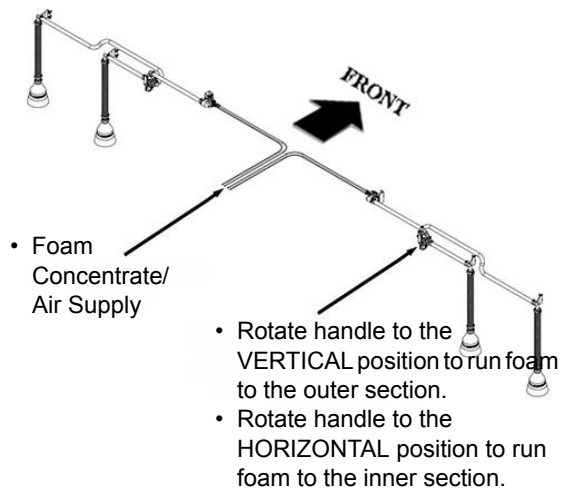

-Typical View

---



---

## APPLICATION

It is important to apply chemicals as recommended by the manufacturer. In order to do so, the spray system console must be properly calibrated.

*NOTE: Refer to the spray system console manufacturer's operation manual for calibration instructions.*

Determine the speed in which the sprayer will travel when applying chemicals. To select the best speed, consider the lay of the land, condition of the soil, type of crop, height of crop, etc.

Remember that the performance of the nozzles (spray tips) and spray system are dependent on the performance of the operator. If the spray system is operated within set parameters of the nozzle type and spray system console, you will see greater success with your application. Operating the machine one or two miles per hour faster or slower than intended will greatly change the outcome of the programmed spray application.

Select nozzle spacing (distance between each nozzle on the spray boom) that is best suited for the intended spray application. For recommendation in determining nozzle spacing and height of the boom, refer to the spray product catalog that accompanies this manual.

There are various types and sizes of nozzles. Select (as recommended by the spray product catalog) and install the appropriate nozzle best suited for the intended spray application. The type of nozzle will depend on the product being applied and the type of crop that it is being used on. The size of nozzles selected will be based on the speed in which the machine will travel, nozzle spacing, and the number of gallons per acre (GPA)/liters per hectare (l/ha) that will be applied.

## Nozzle Selection

There are several things to consider when selecting the correct nozzle type for the intended spray application. Whatever your personal preference is, ensure that the nozzle complies with the chemical manufacturer's standards for spray control and also any environmental standards for your region.

*NOTE: Certain regions may have restrictions on "drift" control.*



Once you have selected the type of nozzle, you must choose the size of the nozzle. There are three main things to consider when choosing a nozzle size:

1. Recommendation of GPA (l/ha).
2. The speed in which you intend to travel when applying chemical and nozzle spacing (distance between nozzles).
3. Spray Tip size (refer to the following example on how to select a proper tip size).

Since all tabulations in the spray product catalog are based on spraying water, you will need to use a conversion factor when spraying liquids other than water. Refer to the spray product catalog for further information.

**Example of how to choose the proper nozzle:**

Joe is spraying 28% nitrogen. The chemical manufacturer recommends that the chemical be applied at 20 gallons per minute

(GPM)/75.7 liters per minute (l/min). Joe knows that he can run his sprayer at 10 mph (16 km/h) across the field. He has 20-inch (50 cm) nozzle spacing on his booms. Joe has narrowed his tip search to flat spray tips.

Use the following conversion formula:

- **20 GPA (187 l/ha) (liquid other than water) x 1.13 (conversion factor) = 22.6 GPA (211.3 l/ha) (water).**

Joe determined that he needs an application rate of 22.6 GPA (211.3 l/ha) to select the correct nozzle to apply 28% nitrogen at 20 GPA (187 l/ha).

To determine which nozzle is better for his intended use, Joe needs to figure out the gallons per minute (GPM)/liters per minute (l/min) he needs to spray.

$$\text{GPM} = \frac{\text{GPA} \times \text{MPH} \times \text{Nozzle Spacing}}{5940 \text{ (Constant)}}$$

$$\text{l/min} = \frac{\text{l/ha} \times \text{km/h} \times \text{Nozzle Spacing}}{60,000}$$

**Examples:**

$$\text{GPM} = \frac{22.6 \times 10 \times 20}{5940} = \frac{4520}{5940} = 0.76 \text{ GPM}$$

$$\text{l/min} = \frac{211.3 \times 16 \times 50}{60,000} = \frac{169040}{60,000} = 2.82 \text{ l/min}$$

**English to Metric Conversion**

- Gallons per Acre (GPA) x 9.354 = Liters per Hectare (l/ha)
- Gallons per Minute (GPM) x 3.785 = Liters per Minute (l/min)

**Metric to English Conversion**

- Liters per Hectare (l/ha) x .1069 = Gallons per Acre (GPA)



- Liters per Minute (l/min) x .26 = Gallons per Minute (GPM)

*NOTE: Always double check your application rates. The following tabulations are based on spraying water at 70° F./21° C.*

| Standard Application Rate Chart |                       |                     |                          |   |      |      |      |      |      |     |     |     |
|---------------------------------|-----------------------|---------------------|--------------------------|---|------|------|------|------|------|-----|-----|-----|
|                                 |                       |                     |                          | Gallons per Acre (GPA) - 15" Nozzle Spacing |      |      |      |      |      |     |     |     |
| Tip Cap.                        | Liquid Pressure (PSI) | Cap. 1 Nozzle (GPM) | Cap. 1 Nozzle (Oz./Min.) | 4   | 6    | 8    | 10   | 12   | 14   | 16  | 18  | 20  |
| 01                              | 15                    | 0.061               | 7.8                      | 6.0   | 4.0  | 3.0  | 2.4  | 2.0  | 1.7  | 1.5 | 1.3 | 1.2 |
|                                 | 20                    | 0.071               | 9.1                      | 7.0   | 4.7  | 3.5  | 2.8  | 2.3  | 2.0  | 1.8 | 1.6 | 1.4 |
|                                 | 30                    | 0.087               | 11                       | 8.6   | 5.7  | 4.3  | 3.4  | 2.9  | 2.5  | 2.2 | 1.9 | 1.7 |
|                                 | 40                    | 0.10                | 13                       | 9.9   | 6.6  | 5.0  | 4.0  | 3.3  | 2.8  | 2.5 | 2.2 | 2.0 |
|                                 | 50                    | 0.11                | 14                       | 10.9  | 7.3  | 5.4  | 4.4  | 3.6  | 3.1  | 2.7 | 2.4 | 2.2 |
|                                 | 60                    | 0.12                | 15                       | 11.9  | 7.9  | 5.9  | 4.8  | 4.0  | 3.4  | 3.0 | 2.6 | 2.4 |
|                                 | 75                    | 0.14                | 18                       | 13.9  | 9.2  | 6.9  | 5.5  | 4.6  | 4.0  | 3.5 | 3.1 | 2.8 |
|                                 | 90                    | 0.15                | 19                       | 14.9  | 9.9  | 7.4  | 5.9  | 5.0  | 4.2  | 3.7 | 3.3 | 3.0 |
| 015                             | 15                    | 0.092               | 12                       | 9.1   | 6.1  | 4.6  | 3.6  | 3.0  | 2.6  | 2.3 | 2.0 | 1.8 |
|                                 | 20                    | 0.11                | 14                       | 10.9  | 7.3  | 5.4  | 4.4  | 3.6  | 3.1  | 2.7 | 2.4 | 2.2 |
|                                 | 30                    | 0.13                | 17                       | 12.9  | 8.6  | 6.4  | 5.1  | 4.3  | 3.7  | 3.2 | 2.9 | 2.6 |
|                                 | 40                    | 0.15                | 19                       | 14.9  | 9.9  | 7.4  | 5.9  | 5.0  | 4.2  | 3.7 | 3.3 | 3.0 |
|                                 | 50                    | 0.17                | 22                       | 16.8  | 11.2 | 8.4  | 6.7  | 5.6  | 4.8  | 4.2 | 3.7 | 3.4 |
|                                 | 60                    | 0.18                | 23                       | 17.8  | 11.9 | 8.9  | 7.1  | 5.9  | 5.1  | 4.5 | 4.0 | 3.6 |
|                                 | 75                    | 0.21                | 27                       | 21  | 13.9 | 10.4 | 8.3  | 6.9  | 5.9  | 5.2 | 4.6 | 4.2 |
|                                 | 90                    | 0.23                | 29                       | 23  | 15.2 | 11.4 | 9.1  | 7.6  | 6.5  | 5.7 | 5.1 | 4.6 |
| 02                              | 15                    | 0.12                | 15                       | 11.9  | 7.9  | 5.9  | 4.8  | 4.0  | 3.4  | 3.0 | 2.6 | 2.4 |
|                                 | 20                    | 0.14                | 18                       | 13.9  | 9.2  | 6.9  | 5.5  | 4.6  | 4.0  | 3.5 | 3.1 | 2.8 |
|                                 | 30                    | 0.17                | 22                       | 16.8  | 11.2 | 8.4  | 6.7  | 5.6  | 4.8  | 4.2 | 3.7 | 3.4 |
|                                 | 40                    | 0.20                | 26                       | 19.8  | 13.2 | 9.9  | 7.9  | 6.6  | 5.7  | 5.0 | 4.4 | 4.0 |
|                                 | 50                    | 0.22                | 28                       | 22  | 14.5 | 10.9 | 8.7  | 7.3  | 6.2  | 5.4 | 4.8 | 4.4 |
|                                 | 60                    | 0.24                | 31                       | 24  | 15.8 | 11.9 | 9.5  | 7.9  | 6.8  | 5.9 | 5.3 | 4.8 |
|                                 | 75                    | 0.27                | 35                       | 27  | 17.8 | 13.4 | 10.7 | 8.9  | 7.6  | 6.7 | 5.9 | 5.3 |
|                                 | 90                    | 0.30                | 38                       | 30  | 19.8 | 14.9 | 11.9 | 9.9  | 8.5  | 7.4 | 6.6 | 5.9 |
| 025                             | 15                    | 0.15                | 19                       | 14.9  | 9.9  | 7.4  | 5.9  | 5.0  | 4.2  | 3.7 | 3.3 | 3.0 |
|                                 | 20                    | 0.18                | 23                       | 17.8  | 11.9 | 8.9  | 7.1  | 5.9  | 5.1  | 4.5 | 4.0 | 3.6 |
|                                 | 30                    | 0.22                | 28                       | 22  | 14.5 | 10.9 | 8.7  | 7.3  | 6.2  | 5.4 | 4.8 | 4.4 |
|                                 | 40                    | 0.25                | 32                       | 25  | 16.5 | 12.4 | 9.9  | 8.3  | 7.1  | 6.2 | 5.5 | 5.0 |
|                                 | 50                    | 0.28                | 36                       | 28  | 18.5 | 13.9 | 11.1 | 9.2  | 7.9  | 6.9 | 6.2 | 5.5 |
|                                 | 60                    | 0.31                | 40                       | 31  | 20   | 15.3 | 12.3 | 10.2 | 8.8  | 7.7 | 6.8 | 6.1 |
|                                 | 75                    | 0.34                | 44                       | 34  | 22   | 16.8 | 13.5 | 11.2 | 9.6  | 8.4 | 7.5 | 6.7 |
|                                 | 90                    | 0.38                | 49                       | 38  | 25   | 18.8 | 15.0 | 12.5 | 10.7 | 9.4 | 8.4 | 7.5 |

SECTION 7 –  
 SPRAY SYSTEMS



|    |    |      |     |      |      |      |      |      |      |      |      |      |
|----|----|------|-----|------|------|------|------|------|------|------|------|------|
| 03 | 15 | 0.18 | 23  | 17.8 | 11.9 | 8.9  | 7.1  | 5.9  | 5.1  | 4.5  | 4.0  | 3.6  |
|    | 20 | 0.21 | 27  | 21   | 13.9 | 10.4 | 8.3  | 6.9  | 5.9  | 5.2  | 4.6  | 4.2  |
|    | 30 | 0.26 | 33  | 26   | 17.2 | 12.9 | 10.3 | 8.6  | 7.4  | 6.4  | 5.7  | 5.1  |
|    | 40 | 0.30 | 38  | 30   | 19.8 | 14.9 | 11.9 | 9.9  | 8.5  | 7.4  | 6.6  | 5.9  |
|    | 50 | 0.34 | 44  | 34   | 22   | 16.8 | 13.5 | 11.2 | 9.6  | 8.4  | 7.5  | 6.7  |
|    | 60 | 0.37 | 47  | 37   | 24   | 18.3 | 14.7 | 12.2 | 10.5 | 9.2  | 8.1  | 7.3  |
|    | 75 | 0.41 | 52  | 41   | 27   | 20   | 16.2 | 13.5 | 11.6 | 10.1 | 9.0  | 8.1  |
|    | 90 | 0.45 | 58  | 45   | 30   | 22   | 17.8 | 14.9 | 12.7 | 11.1 | 9.9  | 8.9  |
| 04 | 15 | 0.24 | 31  | 24   | 15.8 | 11.9 | 9.5  | 7.9  | 6.8  | 5.9  | 5.3  | 4.8  |
|    | 20 | 0.28 | 36  | 28   | 18.5 | 13.9 | 11.1 | 9.2  | 7.9  | 6.9  | 6.2  | 5.5  |
|    | 30 | 0.35 | 45  | 35   | 23   | 17.3 | 13.9 | 11.6 | 9.9  | 8.7  | 7.7  | 6.9  |
|    | 40 | 0.40 | 51  | 40   | 26   | 19.8 | 15.8 | 13.2 | 11.3 | 9.9  | 8.8  | 7.9  |
|    | 50 | 0.45 | 58  | 45   | 30   | 22   | 17.8 | 14.9 | 12.7 | 11.1 | 9.9  | 8.9  |
|    | 60 | 0.49 | 63  | 49   | 32   | 24   | 19.4 | 16.2 | 13.9 | 12.1 | 10.8 | 9.7  |
|    | 75 | 0.55 | 70  | 54   | 36   | 27   | 22   | 18.2 | 15.6 | 13.6 | 12.1 | 10.9 |
|    | 90 | 0.60 | 77  | 59   | 40   | 30   | 24   | 19.8 | 17.0 | 14.9 | 13.2 | 11.9 |
| 05 | 15 | 0.31 | 40  | 31   | 20   | 15.3 | 12.3 | 10.2 | 8.8  | 7.7  | 6.8  | 6.1  |
|    | 20 | 0.35 | 45  | 35   | 23   | 17.3 | 13.9 | 11.6 | 9.9  | 8.7  | 7.7  | 6.9  |
|    | 30 | 0.43 | 55  | 43   | 28   | 21   | 17.0 | 14.2 | 12.2 | 10.6 | 9.5  | 8.5  |
|    | 40 | 0.50 | 64  | 50   | 33   | 25   | 19.8 | 16.5 | 14.1 | 12.4 | 11.0 | 9.9  |
|    | 50 | 0.56 | 72  | 55   | 37   | 28   | 22   | 18.5 | 15.8 | 13.9 | 12.3 | 11.1 |
|    | 60 | 0.61 | 78  | 60   | 40   | 30   | 24   | 20   | 17.3 | 15.1 | 13.4 | 12.1 |
|    | 75 | 0.68 | 87  | 67   | 45   | 34   | 27   | 22   | 19.2 | 16.8 | 15.0 | 13.5 |
|    | 90 | 0.75 | 96  | 74   | 50   | 37   | 30   | 25   | 21   | 18.6 | 16.5 | 14.9 |
| 06 | 15 | 0.37 | 47  | 37   | 24   | 18.3 | 14.7 | 12.2 | 10.5 | 9.2  | 8.1  | 7.3  |
|    | 20 | 0.42 | 54  | 42   | 28   | 21   | 16.6 | 13.9 | 11.9 | 10.4 | 9.2  | 8.3  |
|    | 30 | 0.52 | 67  | 51   | 34   | 26   | 21   | 17.2 | 14.7 | 12.9 | 11.4 | 10.3 |
|    | 40 | 0.60 | 77  | 59   | 40   | 30   | 24   | 19.8 | 17.0 | 14.9 | 13.2 | 11.9 |
|    | 50 | 0.67 | 86  | 66   | 44   | 33   | 27   | 22   | 19.0 | 16.6 | 14.7 | 13.3 |
|    | 60 | 0.73 | 93  | 72   | 48   | 36   | 29   | 24   | 21   | 18.1 | 16.1 | 14.5 |
|    | 75 | 0.82 | 105 | 81   | 54   | 41   | 32   | 27   | 23   | 20   | 18.0 | 16.2 |
|    | 90 | 0.90 | 115 | 89   | 59   | 45   | 36   | 30   | 25   | 22   | 19.8 | 17.8 |
| 08 | 15 | 0.49 | 63  | 49   | 32   | 24   | 19.4 | 16.2 | 13.9 | 12.1 | 10.8 | 9.7  |
|    | 20 | 0.57 | 73  | 56   | 38   | 28   | 23   | 18.8 | 16.1 | 14.1 | 12.5 | 11.3 |
|    | 30 | 0.69 | 88  | 68   | 46   | 34   | 27   | 23   | 19.5 | 17.1 | 15.2 | 13.7 |
|    | 40 | 0.80 | 102 | 79   | 53   | 40   | 32   | 26   | 23   | 19.8 | 17.6 | 15.8 |
|    | 50 | 0.89 | 114 | 88   | 59   | 44   | 35   | 29   | 25   | 22   | 19.6 | 17.6 |
|    | 60 | 0.98 | 125 | 97   | 65   | 49   | 39   | 32   | 28   | 24   | 22   | 19.4 |
|    | 75 | 1.10 | 141 | 109  | 73   | 54   | 44   | 36   | 31   | 27   | 24   | 22   |
|    | 90 | 1.20 | 154 | 119  | 79   | 59   | 48   | 40   | 34   | 30   | 26   | 24   |
| 10 | 15 | 0.61 | 78  | 60   | 40   | 30   | 24   | 20   | 17.3 | 15.1 | 13.4 | 12.1 |
|    | 20 | 0.71 | 91  | 70   | 47   | 35   | 28   | 23   | 20   | 17.6 | 15.6 | 14.1 |
|    | 30 | 0.87 | 111 | 86   | 57   | 43   | 34   | 29   | 25   | 22   | 19.1 | 17.2 |
|    | 40 | 1.00 | 128 | 99   | 66   | 50   | 40   | 33   | 28   | 25   | 22   | 19.8 |
|    | 50 | 1.12 | 143 | 111  | 74   | 55   | 44   | 37   | 32   | 28   | 25   | 22   |
|    | 60 | 1.22 | 156 | 121  | 81   | 60   | 48   | 40   | 35   | 30   | 27   | 24   |
|    | 75 | 1.37 | 175 | 136  | 90   | 68   | 54   | 45   | 39   | 34   | 30   | 27   |
|    | 90 | 1.50 | 192 | 149  | 99   | 74   | 59   | 50   | 42   | 37   | 33   | 30   |
| 15 | 15 | 0.92 | 118 | 91   | 61   | 46   | 36   | 30   | 26   | 23   | 20   | 18.2 |
|    | 20 | 1.06 | 136 | 105  | 70   | 52   | 42   | 35   | 30   | 26   | 23   | 21   |
|    | 30 | 1.30 | 166 | 129  | 86   | 64   | 51   | 43   | 37   | 32   | 29   | 26   |
|    | 40 | 1.50 | 192 | 149  | 99   | 74   | 59   | 50   | 42   | 37   | 33   | 30   |
|    | 50 | 1.68 | 215 | 166  | 111  | 83   | 67   | 55   | 48   | 42   | 37   | 33   |
|    | 60 | 1.84 | 236 | 182  | 121  | 91   | 73   | 61   | 52   | 46   | 40   | 36   |
|    | 75 | 2.05 | 262 | 203  | 135  | 101  | 81   | 68   | 58   | 51   | 45   | 41   |
|    | 90 | 2.25 | 288 | 223  | 149  | 111  | 89   | 74   | 64   | 56   | 50   | 45   |



SECTION 7 -  
SPRAY SYSTEMS

|    |    |      |     |     |     |     |     |    |    |    |    |    |
|----|----|------|-----|-----|-----|-----|-----|----|----|----|----|----|
| 20 | 15 | 1.22 | 156 | 121 | 81  | 60  | 48  | 40 | 35 | 30 | 27 | 24 |
|    | 20 | 1.41 | 180 | 140 | 93  | 70  | 56  | 47 | 40 | 35 | 31 | 28 |
|    | 30 | 1.73 | 221 | 171 | 114 | 86  | 69  | 57 | 49 | 43 | 38 | 34 |
|    | 40 | 2.00 | 256 | 198 | 132 | 99  | 79  | 66 | 57 | 50 | 44 | 40 |
|    | 50 | 2.24 | 287 | 222 | 148 | 111 | 89  | 74 | 63 | 55 | 49 | 44 |
|    | 60 | 2.45 | 314 | 243 | 162 | 121 | 97  | 81 | 69 | 61 | 54 | 49 |
|    | 75 | 2.74 | 351 | 271 | 181 | 136 | 109 | 90 | 78 | 68 | 60 | 54 |
|    | 90 | 3.00 | 384 | 297 | 198 | 149 | 119 | 99 | 85 | 74 | 66 | 59 |



| Metric Application Rate Chart |                     |                       |  |        |        |         |         |         |         |         |         |         |         |
|-------------------------------|---------------------|-----------------------|--|--------|--------|---------|---------|---------|---------|---------|---------|---------|---------|
|                               |                     |                       | Liters per Hectare (l/ha) - 40 cm Nozzle Spacing |        |        |         |         |         |         |         |         |         |         |
| Tip Cap.                      | Liquid Press. (Bar) | Cap. 1 Nozzle (l/min) | 4 km/h   | 6 km/h | 8 km/h | 10 km/h | 12 km/h | 14 km/h | 16 km/h | 18 km/h | 20 km/h | 25 km/h | 30 km/h |
| 01                            | 1.0                 | 0.23                  | 86.3   | 57.5   | 43.1   | 34.5    | 28.8    | 24.6    | 21.6    | 19.2    | 17.3    | 13.8    | 11.5    |
|                               | 1.5                 | 0.28                  | 105  | 70.0   | 52.5   | 42.0    | 35.0    | 30.0    | 26.3    | 23.3    | 21.0    | 16.8    | 14.0    |
|                               | 2.0                 | 0.32                  | 120  | 80.0   | 60.0   | 48.0    | 40.0    | 34.3    | 30.0    | 26.7    | 24.0    | 19.2    | 16.0    |
|                               | 3.0                 | 0.39                  | 146  | 97.5   | 73.1   | 58.5    | 48.8    | 41.8    | 36.6    | 32.5    | 29.3    | 23.4    | 19.5    |
|                               | 4.0                 | 0.45                  | 169  | 113    | 84.4   | 67.5    | 56.3    | 48.2    | 42.2    | 37.5    | 33.8    | 27.0    | 22.5    |
|                               | 5.0                 | 0.50                  | 188  | 125    | 93.8   | 75.0    | 62.5    | 53.6    | 46.9    | 41.7    | 37.5    | 30.0    | 25.0    |
|                               | 6.0                 | 0.55                  | 206  | 138    | 103    | 82.5    | 68.8    | 58.9    | 51.6    | 45.8    | 41.3    | 33.0    | 27.5    |
|                               | 7.0                 | 0.60                  | 225  | 150    | 113    | 90.0    | 75.0    | 64.3    | 56.3    | 50.0    | 45.0    | 36.0    | 30.0    |
| 015                           | 1.0                 | 0.34                  | 128  | 85     | 63.8   | 51.0    | 42.5    | 36.4    | 31.9    | 28.3    | 25.5    | 20.4    | 17.0    |
|                               | 1.5                 | 0.42                  | 158  | 105    | 78.8   | 63.0    | 52.5    | 45.0    | 39.4    | 35.0    | 31.5    | 25.2    | 21.0    |
|                               | 2.0                 | 0.48                  | 180  | 120    | 90.0   | 72.0    | 60.0    | 51.4    | 45.0    | 40.0    | 36.0    | 28.8    | 24.0    |
|                               | 3.0                 | 0.59                  | 221  | 148    | 111    | 88.5    | 73.8    | 63.2    | 55.3    | 49.2    | 44.3    | 35.4    | 29.5    |
|                               | 4.0                 | 0.68                  | 255  | 170    | 128    | 102     | 85.0    | 72.9    | 63.8    | 56.7    | 51.0    | 40.8    | 34.0    |
|                               | 5.0                 | 0.76                  | 285  | 190    | 143    | 114     | 95.0    | 81.4    | 71.3    | 63.3    | 57.0    | 45.6    | 38.0    |
|                               | 6.0                 | 0.83                  | 311  | 208    | 156    | 125     | 104     | 88.9    | 77.8    | 69.2    | 62.3    | 49.8    | 41.5    |
|                               | 7.0                 | 0.90                  | 338  | 225    | 169    | 135     | 113     | 96.4    | 84.4    | 75.0    | 67.5    | 54.0    | 45.0    |
| 02                            | 1.0                 | 0.46                  | 173  | 115    | 86.3   | 69.0    | 57.5    | 49.3    | 43.1    | 38.3    | 34.5    | 27.6    | 23.0    |
|                               | 1.5                 | 0.56                  | 210  | 140    | 105    | 84.0    | 70.0    | 60.0    | 52.5    | 46.7    | 42.0    | 33.6    | 38.0    |
|                               | 2.0                 | 0.65                  | 244  | 163    | 122    | 97.5    | 81.3    | 69.6    | 60.9    | 54.2    | 48.8    | 39.0    | 32.5    |
|                               | 3.0                 | 0.79                  | 296  | 198    | 148    | 119     | 98.8    | 84.6    | 74.1    | 65.8    | 59.3    | 47.4    | 39.5    |
|                               | 4.0                 | 0.91                  | 341  | 228    | 171    | 137     | 114     | 97.5    | 85.3    | 75.8    | 68.3    | 54.6    | 45.5    |
|                               | 5.0                 | 1.02                  | 383  | 255    | 191    | 153     | 128     | 109     | 95.6    | 85.0    | 76.5    | 61.2    | 51.0    |
|                               | 6.0                 | 1.12                  | 420  | 280    | 210    | 168     | 140     | 120     | 105     | 93.3    | 84.0    | 67.2    | 56.0    |
|                               | 7.0                 | 1.21                  | 454  | 303    | 227    | 182     | 151     | 130     | 113     | 101     | 90.8    | 72.6    | 60.5    |
| 025                           | 1.0                 | 0.57                  | 214  | 143    | 107    | 85.5    | 71.3    | 61.1    | 53.4    | 47.5    | 42.8    | 34.2    | 28.5    |
|                               | 1.5                 | 0.70                  | 263  | 175    | 131    | 105     | 87.5    | 75.0    | 65.6    | 58.3    | 52.5    | 42.0    | 35.0    |
|                               | 2.0                 | 0.81                  | 304  | 203    | 152    | 122     | 101     | 86.8    | 75.9    | 67.5    | 60.8    | 48.6    | 40.5    |
|                               | 3.0                 | 0.99                  | 371  | 248    | 186    | 149     | 124     | 106     | 92.8    | 82.5    | 74.3    | 59.4    | 49.5    |
|                               | 4.0                 | 1.14                  | 428  | 285    | 214    | 171     | 143     | 122     | 107     | 95.0    | 85.5    | 68.4    | 57.0    |
|                               | 5.0                 | 1.28                  | 480  | 320    | 240    | 192     | 160     | 137     | 120     | 107     | 96.0    | 76.8    | 64.0    |
|                               | 6.0                 | 1.40                  | 525  | 350    | 263    | 210     | 175     | 150     | 131     | 117     | 105     | 84.0    | 70.0    |
|                               | 7.0                 | 1.51                  | 566  | 378    | 283    | 227     | 189     | 162     | 142     | 126     | 113     | 90.6    | 75.5    |



SECTION 7 -  
SPRAY SYSTEMS

|    |     |      |      |      |      |      |      |      |      |      |      |      |      |
|----|-----|------|------|------|------|------|------|------|------|------|------|------|------|
| 03 | 1.0 | 0.68 | 255  | 170  | 128  | 102  | 85   | 72.9 | 63.8 | 56.7 | 51.0 | 40.8 | 34.0 |
|    | 1.5 | 0.83 | 311  | 208  | 156  | 125  | 104  | 88.9 | 77.8 | 69.2 | 62.3 | 49.8 | 41.5 |
|    | 2.0 | 0.96 | 360  | 240  | 180  | 144  | 120  | 103  | 90.0 | 80.0 | 72.0 | 57.6 | 48.0 |
|    | 3.0 | 1.18 | 443  | 295  | 221  | 177  | 148  | 126  | 111  | 98.3 | 88.5 | 70.8 | 59.0 |
|    | 4.0 | 1.36 | 510  | 340  | 255  | 204  | 170  | 146  | 128  | 113  | 102  | 81.6 | 68.0 |
|    | 5.0 | 1.52 | 570  | 380  | 285  | 228  | 190  | 163  | 143  | 127  | 114  | 91.2 | 76.0 |
|    | 6.0 | 1.67 | 626  | 418  | 313  | 251  | 209  | 179  | 157  | 139  | 125  | 100  | 83.5 |
|    | 7.0 | 1.80 | 675  | 450  | 338  | 270  | 225  | 193  | 169  | 150  | 135  | 108  | 90.0 |
| 04 | 1.0 | 0.91 | 341  | 228  | 171  | 137  | 114  | 97.5 | 85.3 | 75.8 | 68.3 | 54.6 | 45.5 |
|    | 1.5 | 1.12 | 420  | 280  | 210  | 168  | 140  | 120  | 105  | 93.3 | 84.0 | 67.2 | 56.0 |
|    | 2.0 | 1.29 | 484  | 323  | 242  | 194  | 161  | 138  | 121  | 108  | 96.8 | 77.4 | 64.5 |
|    | 3.0 | 1.58 | 593  | 395  | 296  | 237  | 198  | 169  | 148  | 132  | 119  | 94.8 | 79.0 |
|    | 4.0 | 1.82 | 683  | 455  | 341  | 273  | 228  | 195  | 171  | 152  | 137  | 109  | 91.0 |
|    | 5.0 | 2.04 | 765  | 510  | 383  | 306  | 255  | 219  | 191  | 170  | 153  | 122  | 102  |
|    | 6.0 | 2.23 | 836  | 558  | 418  | 335  | 279  | 239  | 209  | 186  | 167  | 134  | 112  |
|    | 7.0 | 2.41 | 904  | 603  | 452  | 362  | 301  | 258  | 226  | 201  | 181  | 145  | 121  |
| 05 | 1.0 | 1.14 | 428  | 285  | 214  | 171  | 143  | 122  | 107  | 95   | 85.5 | 68.4 | 57.0 |
|    | 1.5 | 1.39 | 521  | 348  | 261  | 209  | 174  | 149  | 130  | 116  | 104  | 83.4 | 69.5 |
|    | 2.0 | 1.61 | 604  | 403  | 302  | 242  | 201  | 173  | 151  | 134  | 121  | 96.6 | 80.5 |
|    | 3.0 | 1.97 | 739  | 493  | 369  | 296  | 246  | 211  | 185  | 164  | 148  | 118  | 98.5 |
|    | 4.0 | 2.27 | 851  | 568  | 426  | 341  | 284  | 243  | 213  | 189  | 170  | 136  | 114  |
|    | 5.0 | 2.54 | 953  | 635  | 476  | 381  | 318  | 272  | 238  | 212  | 191  | 152  | 127  |
|    | 6.0 | 2.79 | 1046 | 698  | 523  | 419  | 349  | 299  | 262  | 233  | 209  | 167  | 140  |
|    | 7.0 | 3.01 | 1129 | 753  | 564  | 452  | 376  | 323  | 282  | 251  | 226  | 181  | 151  |
| 06 | 1.0 | 1.37 | 514  | 343  | 257  | 206  | 171  | 147  | 128  | 114  | 103  | 82.2 | 68.5 |
|    | 1.5 | 1.68 | 630  | 420  | 315  | 252  | 210  | 180  | 158  | 140  | 126  | 101  | 84.0 |
|    | 2.0 | 1.94 | 728  | 485  | 364  | 291  | 243  | 208  | 182  | 162  | 146  | 116  | 97.0 |
|    | 3.0 | 2.37 | 889  | 593  | 444  | 356  | 296  | 254  | 222  | 198  | 178  | 142  | 119  |
|    | 4.0 | 2.74 | 1028 | 685  | 514  | 411  | 343  | 294  | 257  | 228  | 206  | 164  | 137  |
|    | 5.0 | 3.06 | 1148 | 765  | 574  | 459  | 383  | 328  | 287  | 255  | 230  | 184  | 153  |
|    | 6.0 | 3.35 | 1256 | 838  | 628  | 503  | 419  | 359  | 314  | 279  | 251  | 201  | 168  |
|    | 7.0 | 3.62 | 1358 | 905  | 679  | 543  | 453  | 388  | 339  | 302  | 272  | 217  | 181  |
| 08 | 1.0 | 1.82 | 683  | 455  | 341  | 273  | 228  | 195  | 171  | 152  | 137  | 109  | 91   |
|    | 1.5 | 2.23 | 836  | 558  | 418  | 335  | 279  | 239  | 209  | 186  | 167  | 134  | 112  |
|    | 2.0 | 2.58 | 968  | 645  | 484  | 387  | 323  | 276  | 242  | 215  | 194  | 155  | 129  |
|    | 3.0 | 3.16 | 1185 | 790  | 593  | 474  | 395  | 339  | 296  | 263  | 237  | 190  | 158  |
|    | 4.0 | 3.65 | 1369 | 913  | 684  | 548  | 456  | 391  | 342  | 304  | 274  | 219  | 183  |
|    | 5.0 | 4.08 | 1530 | 1020 | 765  | 612  | 510  | 437  | 383  | 340  | 306  | 245  | 204  |
|    | 6.0 | 4.47 | 1676 | 1118 | 838  | 671  | 559  | 479  | 419  | 373  | 335  | 268  | 224  |
|    | 7.0 | 4.83 | 1811 | 1208 | 906  | 725  | 604  | 518  | 453  | 403  | 362  | 290  | 242  |
| 10 | 1.0 | 2.28 | 855  | 570  | 428  | 342  | 285  | 244  | 214  | 190  | 171  | 137  | 114  |
|    | 1.5 | 2.79 | 1046 | 698  | 523  | 419  | 349  | 299  | 262  | 233  | 209  | 167  | 140  |
|    | 2.0 | 3.23 | 1211 | 808  | 606  | 485  | 404  | 346  | 303  | 269  | 242  | 194  | 162  |
|    | 3.0 | 3.95 | 1481 | 988  | 741  | 593  | 494  | 423  | 370  | 329  | 296  | 237  | 198  |
|    | 4.0 | 4.56 | 1710 | 1140 | 855  | 684  | 570  | 489  | 428  | 380  | 342  | 274  | 228  |
|    | 5.0 | 5.10 | 1913 | 1275 | 956  | 765  | 638  | 546  | 478  | 425  | 383  | 306  | 255  |
|    | 6.0 | 5.59 | 2096 | 1398 | 1048 | 839  | 699  | 599  | 524  | 466  | 419  | 335  | 280  |
|    | 7.0 | 6.03 | 2261 | 1508 | 1131 | 905  | 754  | 646  | 565  | 503  | 452  | 362  | 302  |
| 15 | 1.0 | 3.42 | 1283 | 855  | 641  | 513  | 428  | 366  | 321  | 285  | 257  | 205  | 171  |
|    | 1.5 | 4.19 | 1571 | 1048 | 786  | 629  | 524  | 449  | 393  | 349  | 314  | 251  | 210  |
|    | 2.0 | 4.83 | 1811 | 1208 | 906  | 725  | 604  | 518  | 453  | 403  | 362  | 290  | 242  |
|    | 3.0 | 5.92 | 2220 | 1480 | 1110 | 888  | 740  | 634  | 555  | 493  | 444  | 355  | 296  |
|    | 4.0 | 6.84 | 2565 | 1710 | 1283 | 1026 | 855  | 733  | 641  | 570  | 513  | 410  | 342  |
|    | 5.0 | 7.64 | 2865 | 1910 | 1433 | 1146 | 955  | 819  | 716  | 637  | 573  | 458  | 382  |
|    | 6.0 | 8.37 | 3139 | 2093 | 1569 | 1256 | 1046 | 897  | 785  | 698  | 628  | 502  | 419  |
|    | 7.0 | 9.04 | 3390 | 2260 | 1695 | 1356 | 1130 | 969  | 848  | 753  | 678  | 542  | 452  |



|    |     |       |      |      |      |      |      |      |      |      |     |     |     |
|----|-----|-------|------|------|------|------|------|------|------|------|-----|-----|-----|
| 20 | 1.0 | 4.56  | 1710 | 1140 | 855  | 684  | 570  | 489  | 428  | 380  | 342 | 274 | 228 |
|    | 1.5 | 5.58  | 2093 | 1395 | 1046 | 837  | 698  | 598  | 523  | 465  | 419 | 335 | 279 |
|    | 2.0 | 6.44  | 2415 | 1610 | 1208 | 966  | 805  | 690  | 604  | 537  | 483 | 386 | 322 |
|    | 3.0 | 7.89  | 2959 | 1973 | 1479 | 1184 | 986  | 845  | 740  | 658  | 592 | 473 | 395 |
|    | 4.0 | 9.11  | 3416 | 2278 | 1708 | 1367 | 1139 | 976  | 854  | 759  | 683 | 547 | 456 |
|    | 5.0 | 10.19 | 3821 | 2548 | 1911 | 1529 | 1274 | 1092 | 955  | 849  | 764 | 611 | 510 |
|    | 6.0 | 11.16 | 4185 | 2790 | 2093 | 1674 | 1395 | 1196 | 1046 | 930  | 837 | 670 | 558 |
|    | 7.0 | 12.05 | 4519 | 3013 | 2259 | 1808 | 1506 | 1291 | 1130 | 1004 | 904 | 723 | 603 |

*NOTE: The previous tabulations are based on 15-inch/40 cm nozzle spacing. Refer to the spray product catalog for tabulations if choosing spacing other than 15"/40 cm.*

## Verifying Calibration

WARNING

Do not add chemicals until calibration is complete. Contact with chemicals may cause serious injury or death.

To test your system, fill the solution tank with clean water. **Do not add chemicals until calibration is complete.**

1. Apply the parking brake.
2. Start the engine.
3. Throttle the engine to operating speed.
4. Turn the spray system console ON.
5. Change the drive state of the machine to Field Mode on the MD3 Monitor.
6. Press the Tank Valve Switch (located on the side console) in the UP (Open) position.
7. Press the Master Spray Switch (located on the Hydrostatic Drive Control Handle) in the ON position.
8. Press all Boom Solution Valve Switches (located on the side console) in the ON position.
9. Ensure there are no leaks and that all nozzles are spraying a desirable pattern.
10. Continue spraying in the stationary position for at least 10 minutes for proper warm-up of the sprayer and system.

Once the sprayer has had an adequate warm-up period, you will need to perform a “self test” to simulate speed (although the machine will remain stationary).

*NOTE: The following “self-test” steps require measuring flow at given pressure.*

- Collect one nozzle’s spray for one (1) minute in an adequately sized and marked container.
- Verify that the collection equals or is close to the GPM (l/min) for the nozzle, pressure, speed, GPA (l/ha), and spacing that you are using.

Also to ensure accuracy, you will need to verify the flow meter. To do so:

- Collect one nozzle’s spray for one (1) minute and multiply it by the number of nozzles on the boom. This should equal the amount measured through the flow meter.

### Raven Spray System Console

#### -If Equipped

If your machine is equipped with a Raven Spray System Console, a SPEED CAL value must be entered. This value is determined by the wheel motor and tire size. The following chart lists a variety tire options with the corresponding SPEED CAL number.

*NOTE: These calibration numbers are a starting point. Use the Raven distance tabulator to obtain final calibration number.*



**Further Information**

Refer to the manufacturer’s operation manual for complete operating instructions, troubleshooting tips, and safety precautions.

| STS16 Raven Speed Cal Values |            |            |            |             |            |
|------------------------------|------------|------------|------------|-------------|------------|
| Standard Units               |            |            |            |             |            |
| 380/85 R46                   | 520/85 R46 | 580/70 R38 | 320/90 R50 | 320/105 R54 | 380/90 R54 |
| <b>294</b>                   | <b>329</b> | <b>294</b> | <b>297</b> | <b>329</b>  | <b>329</b> |
| SI Units                     |            |            |            |             |            |
| 380/85 R46                   | 520/85 R46 | 580/70 R38 | 320/90 R50 | 320/105 R54 | 380/90 R54 |
| <b>75</b>                    | <b>84</b>  | <b>75</b>  | <b>76</b>  | <b>84</b>   | <b>84</b>  |

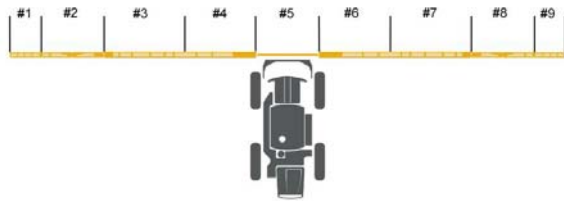

90' Boom with 9 Spray Sections  
(Standard)  
-Typical View

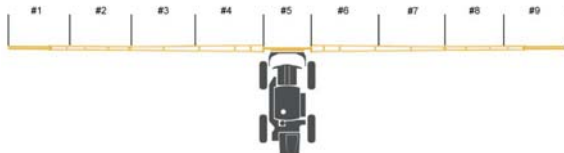

120'/132' Boom with 9 Spray Sections  
(Standard)  
-Typical View

**Number of Nozzles x Nozzle Spacing  
= Spray Section Width**

**Example:**

Section 1 of a 120-ft. boom with 15-inch (38 cm) nozzle spacing (Section 1 has 10 spray nozzles).

**10 Nozzles x 15 (Nozzle Spacing)  
= 150" (Section Width)**

**10 Nozzles x 38 (Nozzle Spacing)  
= 380 cm (Section Width)**

**Further Information**

Refer to the spray system console manufacturer’s operation manual for complete operating and calibrating instructions, troubleshooting tips, and safety precautions.

**Calculating Spray Width**

The spray section widths will need to be entered into the spray system console during initial set-up. No matter what the length of the boom is or how many spray sections it has, the formula for calculating section widths are the same.

## SECTION 8 – MAINTENANCE AND STORAGE

### SERVICE - FLUIDS

#### Hydraulic Oil

### NOTICE

Ensure area is clean before changing hydraulic oil and filters to avoid contamination, such as dirt and debris. Failure to comply may result in severe hydraulic system damage.

Check the Hydraulic Oil Reservoir Sight Gauge level daily. Add just enough fluid to maintain oil level at mid sight gauge.

*NOTE: Hydraulic oil expands when heated. Always check oil level when it is cool.*



Hydraulic Oil Reservoir  
(Located on left-hand side of machine - open hood to access)  
-Typical View

Premium hydraulic fluids containing high quality rust, oxidation, and foam inhibitors are required. Hagie Manufacturing Company recommends Mobilfluid® 424.

*NOTE: Replace hydraulic oil every 1,000 hours of operation.*

#### Wheel Hub Oil

##### Bonfiglioli Wheel Hub Oil Level

Each wheel hub should maintain a proper oil level at all times. Less than that would limit lubrication and overfilling would cause overheating and machine damage.

##### To check the oil level:

*NOTE: Check wheel hub oil level every 100 hours of operation.*

1. Position wheel hub so one of the face plugs is positioned at 12 o'clock (A). The other plug will be positioned at 8 o'clock (B).

*NOTE: When positioned correctly, the arrows in the center of the wheel hub should make an "L".*

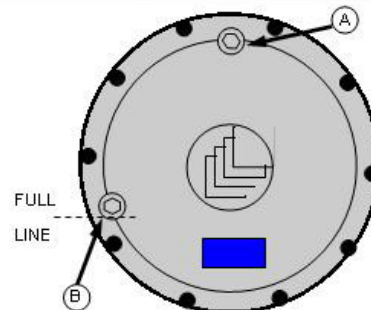

2. Remove the bottom plug.  
If no oil comes out, the oil level is too low.

*NOTE: Hagie Manufacturing Company recommends Mobil Delvac™ synthetic gear oil (75W-90) with EP features (complying with API GL-5 specifications).*

3. If oil is needed, remove the top plug and fill just until oil begins to come out of the lower hole.
4. Reinstall plugs when oil level is satisfactory.

**To change the oil:**

*NOTE: Wheel hub oil should be changed after the first 50 hours of operation. After that, it should be changed every 250 hours or yearly, whichever occurs first.*

1. Position wheel hub so one of the face plugs is positioned at 6 o'clock and the other plug is positioned between the 2 and 3 o'clock positions.
2. Remove both plugs to drain oil.
3. Once all of the oil is drained, rotate the wheel hub so that the plugs are in the "filling" position.
4. Refill wheel hub with oil as previously described.

**General Maintenance**

|   |
|---|
| <b>NOTICE</b>   |
| Failure to rotate the wheel hub and disperse oil may cause rusting and internal wheel hub damage. |

If your machine is going to sit unused for an extended period of time, occasionally rotate the wheel hubs by driving the machine forward and backward - at least half of a tire rotation to adequately coat all internal wheel hub parts. This will prevent rusting if moisture inadvertently entered the wheel hub during an oil change.

**Fairfield Wheel Hub Oil Level - If Equipped**

Each wheel hub should maintain a proper oil level at all times. Less than that would limit lubrication and overfilling would cause overheating and machine damage.

**To check the oil level:**

*NOTE: Check wheel hub oil level every 100 hours of operation.*

1. Position wheel hub so one of the face plugs is positioned at 12 o'clock. The

other plug will be positioned at either 3 or 9 o'clock.

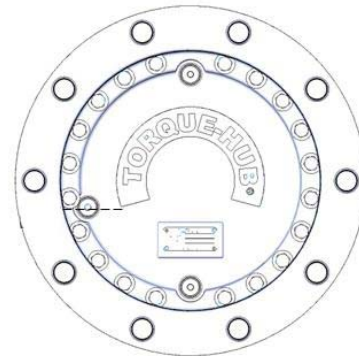

2. Remove the lower of the two plugs. If no oil comes out, the oil level is too low.

*NOTE: Hagie Manufacturing Company recommends Mobil Delvac™ synthetic gear oil (75W-90) with EP features (complying with API GL-5 specifications).*

3. If oil is needed, remove the top plug and fill just until oil begins to come out of the lower hole.
4. Reinstall plugs when oil level is satisfactory.

**To change the oil:**

*NOTE: Wheel hub oil should be changed after the first 50 hours of operation. After that, it should be changed every 250 hours or yearly, whichever occurs first.*

1. Position wheel hub so one of the face plugs is positioned at 6 o'clock and the other plug is positioned at either the 3 or 9 o'clock positions.
2. Remove plugs to drain the oil.
3. Once all of the oil is drained, reinstall the bottom plug and remove the 3 or 9 o'clock plug.
4. Refill oil until satisfactory level is met.
5. Reinstall the plug.

## General Maintenance

### NOTICE

Failure to rotate the wheel hub and disperse oil may cause rusting and internal wheel hub damage.

If your machine is going to sit unused for an extended period of time, occasionally rotate the wheel hubs by driving the machine forward and backward - at least half of a tire rotation to adequately coat all internal wheel hub parts. This will prevent rusting if moisture inadvertently entered the wheel hub during an oil change.

## Engine Oil

### NOTICE

Never operate the engine with oil level below the “L” (low) mark or above the “H” (high) mark on the engine oil dipstick.

### NOTICE

The engine must be level when checking oil level to ensure accuracy.

The Engine Oil Dipstick is located on the left-hand side of the engine. Wait at least five (5) minutes after shutting the engine off to check the oil level.

*NOTE: Check the engine oil level daily.*



Engine Oil Dipstick  
(Located on the left-hand side of engine)  
-Typical View

## Capacity

- Engine Oil Dipstick (low to high mark) = 2 quarts (1.9 L)
- Engine Oil Pan (including crankcase, lines, filter, and cooler) = 25 quarts (23.7 L)

## Type

- Valvoline Premium Blue® Diesel Engine Oil - 15W-40 (recommended)

*NOTE: Change the engine oil every 250 hours of operation or yearly, whichever occurs first.*

## Cooling System

The cooling system should be sufficiently charged with an adequate mixture of antifreeze and water, regardless of climate, to maintain broad operating temperature range. Follow the coolant manufacturer’s recommendations for your climate.

*NOTE: The cooling system has been factory-filled with an ethylene glycol-based antifreeze.*

## Checking Concentration



The Radiator Cap is located near the engine compartment.

*NOTE: Never remove the Radiator Cap from a hot engine. Always allow the engine to cool before servicing the cooling system. Check coolant level daily.*

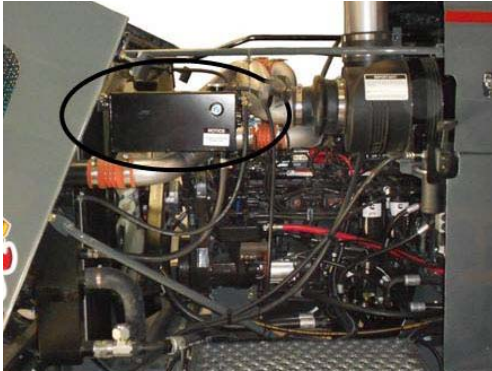

Radiator Cap  
(Located in the engine compartment)  
-Typical View

A 50/50 ethylene glycol and water mixture is a conservative mixture, which allows protection against both overheating and freezing.

*NOTE: If a stronger antifreeze mixture is required, ensure not to exceed the engine manufacturer’s guidelines for antifreeze-water mixing. Refer to “ASTM D 6210” or “ASTM D 7715” standards for further information.*

The following Ethylene Glycol Table gives a few examples of ethylene glycol antifreeze/water mixture protection values.

| Ethylene Glycol |        |        |
|-----------------|--------|--------|
| 40%             | -23° C | -10° F |
| 50%             | -37° C | -34° F |
| 60%             | -54° C | -65° F |

Concentration should be checked every 500 hours of operation or at the beginning of each spray season, whichever occurs first. A refractometer should be used to check concentration.

*NOTE: “Floating Ball” type density testers are not accurate for use with a heavy duty diesel cooling system.*

### Changing Coolant

Coolant should be changed periodically to eliminate the buildup of harmful chemicals. Drain and replace the coolant every other spray season or 1,000 hours of operation, whichever occurs first. Refill with soft water only, as hard water contains minerals, which break down the anti-corrosion properties of the antifreeze.

### Further Information

Refer to the engine manufacturer’s operation manual for further information.

### Fuel

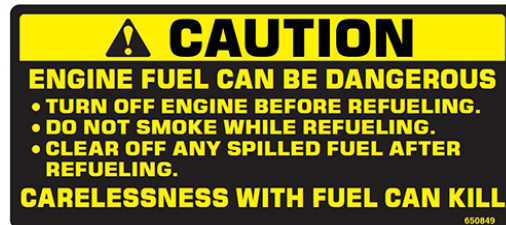

*NOTE: Keep a fire extinguisher nearby when refueling.*

DO NOT fill fuel tank completely. Fuel can expand and run over. Wipe up all spilled fuel and clean with detergent and water before starting the engine.

### Fuel Recommendation

- No. 2 diesel fuel is recommended for best economy and performance under most operating conditions. (In operating conditions less than 32° F., use a blend of No. 1 and No. 2 diesel fuel).

*NOTE: The addition of No. 1 diesel fuel may cause loss of power and/or fuel economy.*

## Air Conditioning

### NOTICE

Charge with R134A refrigerant only.  
Charge to 3 lbs.

The cab is equipped with an R134A Air Conditioning System. **Recharge system with R-134A refrigerant only.**

*NOTE: Confirm refrigerant before recharging the Air Conditioning System. If your system is mistakenly recharged with R-12 refrigerant, machine damage (such as compressor seizure) may result. If you do not have the proper equipment, it is recommended that you allow an authorized service technician service your Air Conditioning System.*



A/C Charge Port  
(Located on right-hand side of machine - open hood to access)  
-Typical View

## Windshield Washer Fluid

The Windshield Washer Fluid Reservoir is located behind the left-hand side of cab. Check fluid level occasionally and fill with non-freezing automotive windshield washer fluid, as required.



Windshield Washer Fluid Reservoir  
(Located behind the left-hand side of cab)  
-Typical View

---

---

## SERVICE - FILTERS

### Engine Air Intake

The Engine Air Intake Filter is located near the engine compartment (open hood to access).

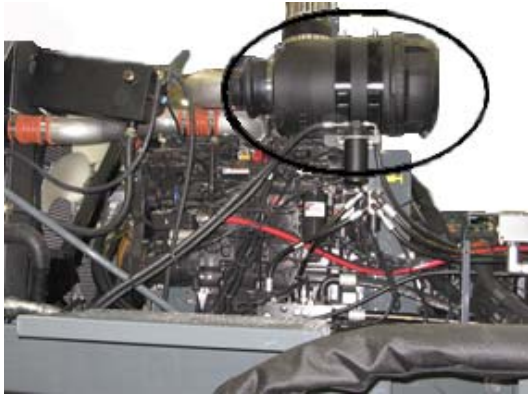

Engine Air Intake Filter  
(Located near engine compartment -  
open hood to access)  
-Typical View

## NOTICE

Do not tap filter to remove dust. A crushed filter caused by tapping may result in engine damage. Remove and replace filter as recommended.

### Removal

The Engine Air Intake Filter should only be removed if replacement is required.

- Loosen the air cleaner and remove end cap.
- Remove filter. Use care when removing the filter to ensure dust from the filter does not enter the air intake passage.

*NOTE: The secondary filter does not need to be replaced if the primary filter is intact.*

### Replacement

Your machine is equipped with a Filter Minder® to notify you of filter element efficiency. Refer to the following service guidelines.

### Cleaning

It is not recommended to clean the Engine Air Intake Filter element. However, a clean damp cloth should be used to wipe away dust and debris from the air cleaner housing.

### Filter Minder

The Filter Minder (located on the Foam Marker tank mounting bracket) is an air restriction monitoring system that progressively and constantly indicates how much air filter capacity remains.

*NOTE: Check Filter Minder reading daily.*



Filter Minder  
(Located on the Foam Marker  
tank mounting bracket)  
-Typical View

### Service

- Replace air filter when yellow indicator on the filter gauge reaches red line.
- Press the Reset Button (located on the Filter Minder) at each service.

### Radiator Screen

## NOTICE

Failure to keep cooling systems clean can cause overheating and damage to the engine and hydrostatic drive systems.

To maintain airflow through the engine cooling system's radiator, oil cooler, and air conditioning condenser, the cooling air intake grille must be inspected often and cleaned periodically.

When the engine hood has been opened for servicing, use compressed air to dislodge large debris and dirt. Blow out the screen away from the machine. Water from a pressurized hose may also be used or if necessary, the screen may be soaked with soapy water and scrubbed gently with a brush.

*NOTE: When cleaning the cooling fins of the radiator, oil cleaner, or A/C condenser with compressed air or water, be careful not to damage the cooling fins, which may impair cooling capabilities.*

### Engine Oil Filter

The Engine Oil Filter (located near the hydraulic oil reservoir) should be replaced every 250 hours of operation or whenever the oil is changed.



Engine Oil Filter  
(Located near the hydraulic oil reservoir)  
-Typical View

### Coolant Filter

The diesel engine is equipped with a Coolant Filter (located near the hydraulic oil reservoir). Use Cummins® test strips to test the nitrate level twice per year (minimum), preferably whenever coolant is added.

Replace the Coolant Filter every 500 hours of operation, or as necessary.

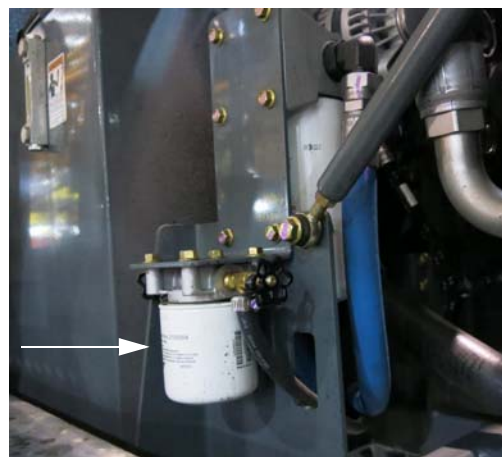

Coolant Filter  
(Located near the hydraulic oil reservoir)  
-Typical View

### Auxiliary Hydraulic Cooling System Fan

Your machine is equipped with an Auxiliary Hydraulic Cooling System Fan (located behind the solution tank on the right-hand side of machine). This system aids in maintaining hydraulic oil operating temperature.

To maintain adequate airflow through the cooling system, the fan grille must be inspected and cleaned periodically.



Auxiliary Hydraulic Cooling Fan  
(Located behind solution tank  
on the right-hand side of machine)  
-Typical View



## Fuel Filters and Strainers

### Primary Fuel Filter/Water Separator (A)

The Primary Fuel Filter (located on the right-hand side of engine) should be drained of water and other deposits daily. Replace the filter every 500 hours of operation or yearly, whichever occurs first.

### Secondary Fuel Filter (B)

The Secondary Fuel Filter (located on the right-hand side of engine) should be replaced every 500 hours of operation or yearly, whichever occurs first.

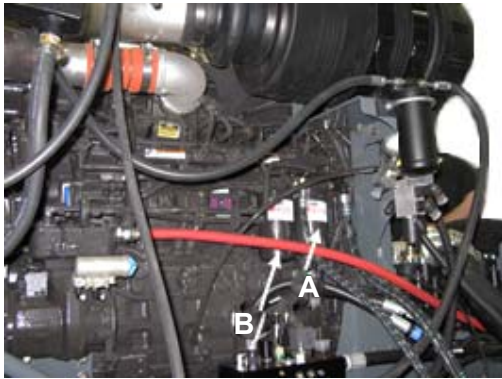

Primary and Secondary Fuel Filters  
(Located on the right-hand side of engine)  
-Typical View

*NOTE: Refer to the engine manufacturer's operation manual for further information and filter recommendations.*

## Hydraulic Filters and Strainers

*(Refer to your Parts Manual for specific location and replacement part numbers)*

- Return Filter
- Suction Strainers
- Fill Screen

### Return Filter

- Replace the Return Filter (located inside filter housing on top of the hydraulic oil reservoir) every 250 hours of operation or yearly, whichever occurs first.

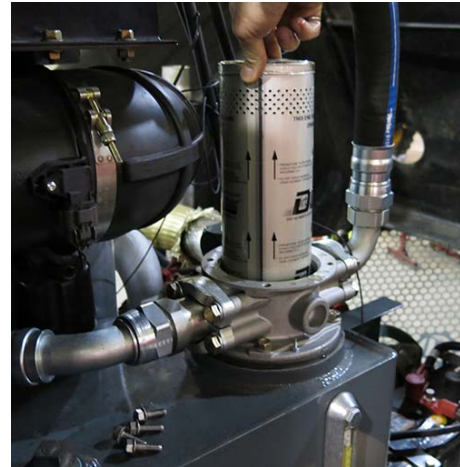

Hydraulic Return Filter  
(Located inside filter housing  
on top of hydraulic oil reservoir  
-Typical View

### Suction Strainers

- The Suction Strainers (located inside of the tank) should be inspected for wear and blockage when the tank is empty for fluid service.

### Fill Screen

- The Fill Screen is the first defense against foreign material entering the tank. Replace screen immediately if any signs of tearing or breakage occur.

### Other Strainers

*(Refer to your Parts Manual for specific location and replacement part numbers)*

### Rinse Tank Strainer

#### - If Equipped

If your machine is equipped with a pressure washer system, it will have a mesh strainer between the rinse tank and the pressure washer. Inspect the strainer for blockage and clean or replace if you are unable to obtain adequate pressure.

### Solution Line Strainer

Maintain consistent application rates by inspecting the Solution Line Strainer daily for blockage. Clean the strainer screen as needed and ensure the gasket is in place before reinstalling the screen.

*NOTE: Wear appropriate clothing while removing and cleaning the strainer screen.*

## Cab Filters

*NOTE: Refer to your Parts Manual for replacement part number.*

### Paper Filter

Remove and clean the Paper Filter every 50 hours of operation, or as necessary.

- Tap filter gently against flat surface.
- Use low-pressure compressed air to remove larger particles.
- Replace the Paper Filter if necessary.

### Charcoal Filter

Remove and replace Charcoal Filter at the first sign of chemical entering the cab.

### Filter Removal and Replacement

1. Unfasten the screws (located on each side of the Cab Filter Access Panel behind the operator's seat).



Cab Filter Access Panel  
(Located behind operator's seat)  
-Typical View

2. Carefully remove filters and clean or replace as recommended.
3. Wipe access panel with a clean cloth before reinstalling.

### Fresh Air Tube

The Fresh Air Tube (located behind cab) allows fresh air into the cab area. Inspect often for foreign material blocking the opening.



Fresh Air Tube  
(Located behind the cab)  
-Typical View

---

---

## SERVICE - LUBRICATION

### NOTICE

Failure to properly lubricate pivot and friction points may result in unnecessary wear and damage.

## Legs and Steering

### Tie Rod Ball (front legs)

- Lubricate every 25 hours of operation, or as needed.

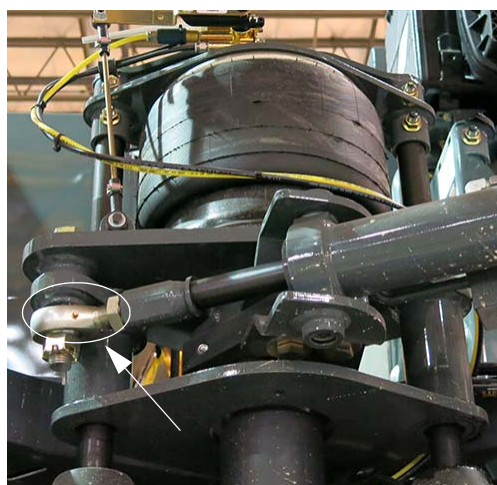

Tie Rod Ball Grease Zerk  
(Located on the front legs)  
-Typical View

**All-Wheel Steer (AWS) ^**

**- If Equipped**

If your machine is equipped with AWS, the steering cylinders on the rear legs also have grease zerks in the tie rod ends that require lubrication.

**Tower Bearing (front and rear legs)**

- Lubricate daily, or as needed.



Tower Bearing Grease Zerk  
(Located on the front and rear legs)  
-Typical View

**Leg Tubes (front and rear legs)**

*NOTE: Initial greasing should fill the grease space until grease escapes the Pressure Relief Valve - between 40-80 psi (2.8 - 5.5 bar).*

- Lubricate the legs daily. When grease escapes the Pressure Relief Valve, the proper grease level has been reached.



Leg Tube Grease Zerk and  
Pressure Relief Valve  
(Located on front and rear legs)  
-Typical View

**Collar (beneath air bag mounting plate)**

- Lubricate every 50 hours of operation, or as needed.



Collar Grease Zerk  
(Located beneath each  
air bag mounting plate)  
-Typical View

**Ladder Pivot Tube**

Lubricate the grease zerk (located on the back side of the Ladder Pivot Tube) every 50 hours of operation, or as required.

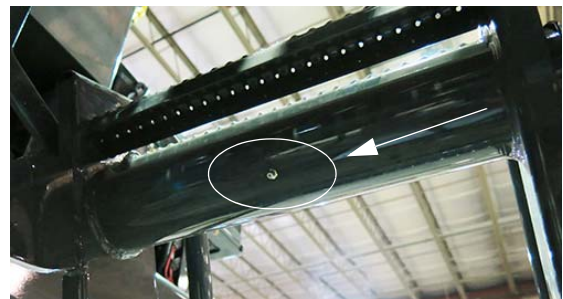

Ladder Pivot Tube  
-Typical View

## 90 and 100-ft. Booms

### Transom Pivot Tubes

Lubricate the grease zerk on the Transom Pivot Tube - one on each side (that attaches the boom to the transom) every 50 hours of operation, or as needed.



Transom Pivot Tube  
-Typical View

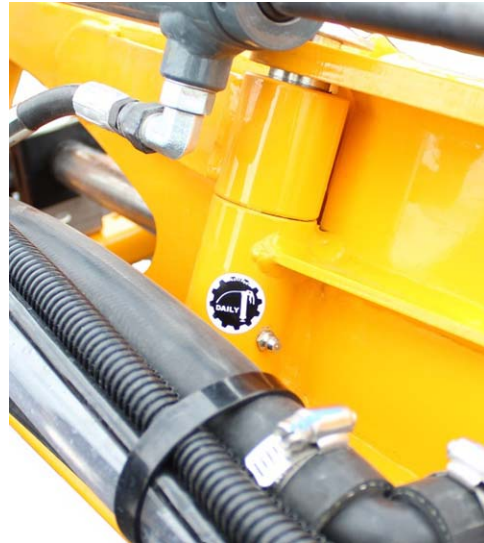

Boom Breakaway  
-Typical View

### Boom Breakaway Cylinder Rod End

Lubricate the grease zerk on the Boom Breakaway Cylinder Rod Ends daily, or as needed.

### Boom Fold

Lubricate the Boom Fold (where the main boom section connects to the boom extension) daily, or as needed.



Boom Fold  
-Typical View

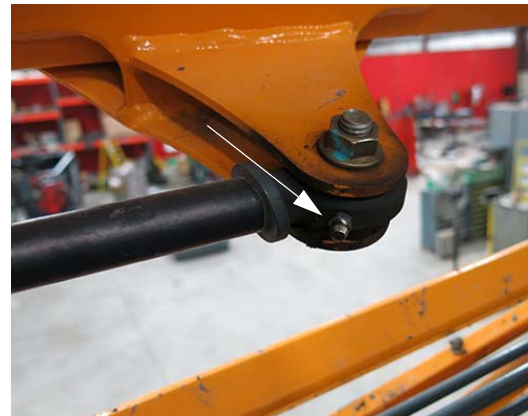

Boom Breakaway Cylinder Rod End  
-Typical View

## 120 and 132-ft. Booms

### - If Equipped

### Pendulum

Lubricate the grease zerk on each Pendulum daily, or as needed.

### Boom Breakaway

Lubricate the grease zerk on the Boom Breakaway daily, or as needed.



Pendulum  
-Typical View

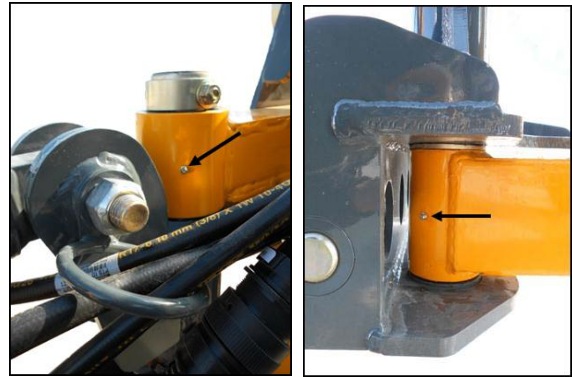

Pivot Transom  
-Typical View

### Roller Mount Assembly

Lubricate the three (3) bearings on each Roller Mount Assembly daily, or as needed.

*NOTE: Failure to keep the rollers properly lubricated may result in roller seizure.*



Roller Mount Assembly  
-Typical View

### Pivot Transom Ball Joints

Lubricate the two (2) Pivot Transom Ball Joint grease zerkers (located on the left and right-hand side of the Pivot Transom) every 25 hours of operation, or as needed.



Pivot Transom Ball Joints  
-Typical View

### Pivot Transom

Lubricate the four (4) Pivot Transom grease zerkers (located at the top and bottom of each Pivot Transom) every 50 hours of operation, or as needed.

### Boom Adapter

Lubricate the two (2) grease zerkers on each Boom Adapter every 25 hours of operation, or as needed.



Boom Adapter  
-Typical View

### Boom Fold Linkages

Lubricate the ten (10) grease zerks on the Boom Fold Linkages every 50 hours of operation, or as needed.



Boom Fold Linkages  
-Typical View

---

---

## SERVICE - BELTS

### Engine Drive Belt

#### Removal

- Insert a 1/2" square ratchet drive into the belt tensioner (A).

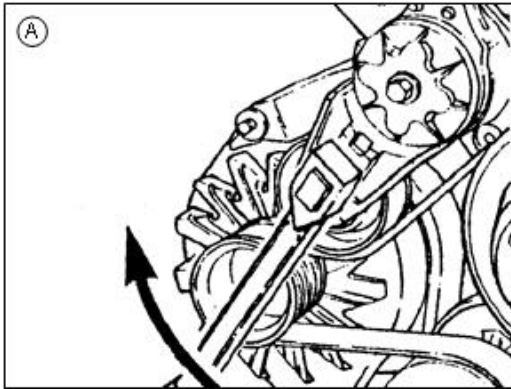

- Lift UP and remove the Engine Drive Belt (B).

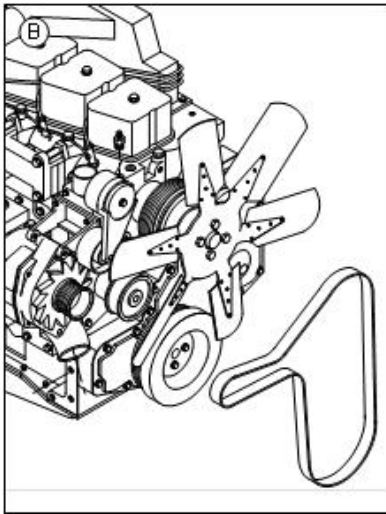

**Inspection**

- Visually inspect the Engine Drive Belt daily.
- Check the belt for intersecting cracks (C).

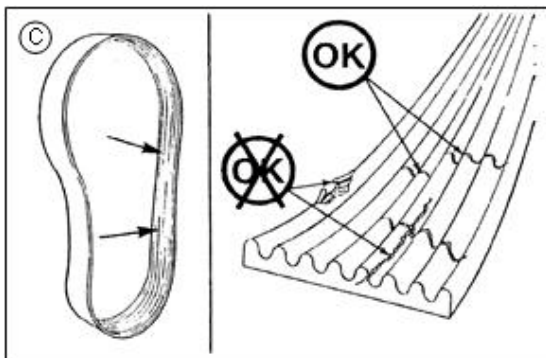

*NOTE: Transverse cracks (across the belt width) are acceptable. Longitudinal cracks (direction of the belt length) that intersect with transverse cracks are not acceptable.*

- Replace the Engine Drive Belt if it is frayed or has material missing.

**A/C Compressor Belt**

Visually inspect the A/C Compressor Belt daily. Replace the belt if it is frayed or has missing material.

- To tighten the A/C Compressor Belt, loosen the three pivot bolts (A) and nut (B) just enough to allow movement.

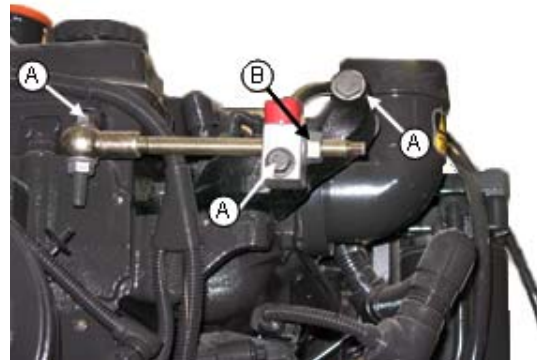

-Typical View

- Turn the spindle counter-clockwise (toward fan) to loosen belt tension, or turn clockwise (away from fan) to tighten belt tension.

SERVICE - BOLT TORQUE

NOTICE

Check lug nut torque immediately after receiving the machine and every 50 hours of operation thereafter.

**Wheel Bolts**

If you do not have the proper equipment to mount a tire, contact a local qualified tire service center.

The tire should be mounted on the rim (as shown in the following illustration) for best traction and tread cleaning action.



**To install wheel/tire assembly onto the wheel hub:**



1. Ensure threads are thoroughly cleaned of rust and dirt.

*NOTE: Threads should be dry (no lubricant).*

2. Align the wheel bolt holes with the wheel hub studs.
3. Mount wheel on the hub.
4. Start all of the lug nuts and tighten until snug.
5. Following the torque sequence (as shown the following illustration), turn each lug nut to a torque value of 120 dry ft.-lbs.

*NOTE: Use slow, even pressure on the torque wrench. Quick or jerky movements can cause inaccurate values.*

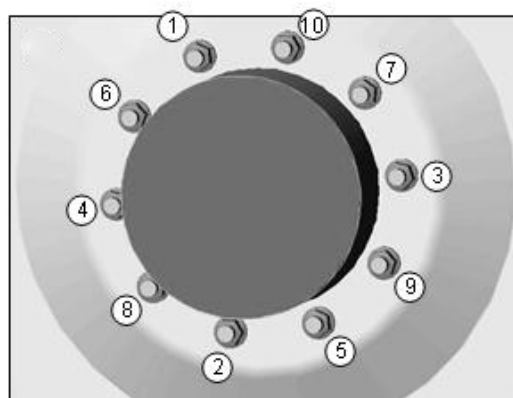

Torque Sequence

6. Repeat the same sequence to 150 dry ft.-lbs. and again to 400-500 dry ft.-lbs.

*NOTE: If the wheel turns during lug nut torquing, lower machine to the ground - just enough for the tire to touch and prevent rotation. Or, more preferably, place a suitable wedge between the tire and the ground. Lower the machine and resume operation. Recheck torque after 30 minutes of operation.*

7. When torquing is complete, lubricate exposed threads with anti-seize grease.

### Hydraulic Tread Adjust Machines

With the engine turned OFF, visually inspect the tread bearing bolts on both the bottom and side tread adjust bearing plates every 50 hours of operation. Inspect the torque every 100 hours of operation.

#### To check torque of the tread adjust bearing bolts:

1. Loosen the jam nut on each tread adjust bearing bolt.





Jam Nut  
(Located on each tread adjust bearing bolt)  
-Typical View

- Using an “X” pattern (as shown in the following photo), verify that the current torque on each tread adjust bearing bolt is equivalent to the last inspection from 100 hours of previous operation.

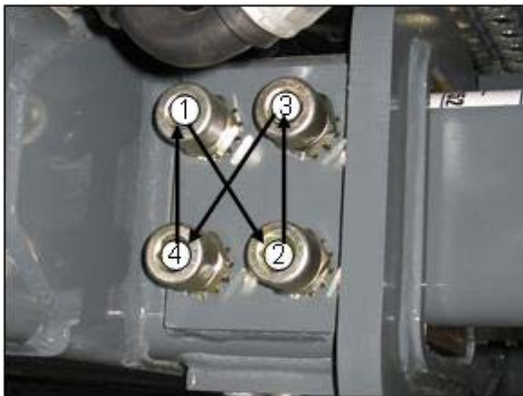

“X” Pattern  
-Typical View

- Repeat pattern 3 to 4 times until the last sequence shows no movement of the bolts to achieve desired torque.
- Tighten jam nut.

Typically, a torque value of 20 to 25 ft.-lbs. is required to stabilize the axle and still allow tread width adjustment.

**NOTE:** *Never operate machine with loose or missing tread plates. To visually inspect for loose tread plates, slowly rock the machine forward and backwards while observing the legs*

*for movement. If plates become loose, the leg will rock as the machine starts to move.*

## NOTICE

If hydraulic tread adjust will never be used, set all bolt torque settings to 50 ft.-lbs. using the following procedure.

### EVEN PRESSURE OF THE TREAD ADJUST BEARING PLATES IS REQUIRED FOR PROPER OPERATION.

- Figure A** - shows correct position of the tread adjust bearing plates and bolts, as well as the outer leg.
- Figure B** - shows the plates when there is not even torque on each of the tread adjust bearing bolts.
- Figure C** - shows a situation in which there is not enough torque on the tread adjust bearing bolts.

**NOTE:** *Both Figures B and C will cause the tread adjust to operate incorrectly, or not at all.*

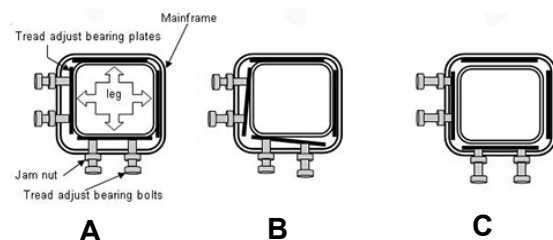

## SERVICE - TOE-IN

### Setting Toe-In

#### Front Wheels

- .25” (.6 cm) Toe-In per side/0.5” (1.3 cm) total Toe-In

### Rear Wheels

- 0” (0 cm) Toe-In/Out

*NOTE: Initial wheel alignment should be performed with steering cylinders “unpinned” from the leg.*

1. Deflate the air bags.

*NOTE: Refer to “Air Suspension Exhaust” provided in the Miscellaneous Section elsewhere in this manual for further information.*

2. Measure the distance from the ground to center of wheel hub.

*NOTE: All four wheel hubs should measure the same distance.*

3. Mark this distance on the inner edge of the wheel rim (front and back of each rim - 8 marks total).

*NOTE: All measurements will be taken from these markings.*

4. Visually align the tires from front to rear. See following illustration.

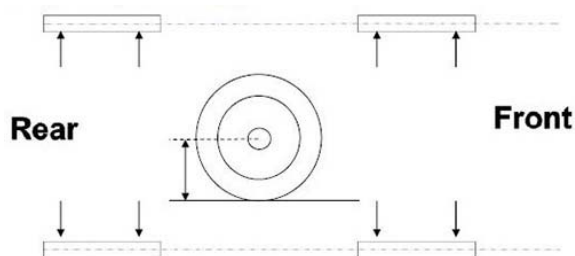

### Front Wheels

5. Measure the width between the front wheels (front W1, rear W2) at the wheel hub center line and record measurements.
6. Adjust the wheels until the front and rear measurements are equal ( $W1=W2$ ).
7. Measure diagonally (D1 and D2) and record the measurements.
8. Adjust the wheels until the measurements are equal.

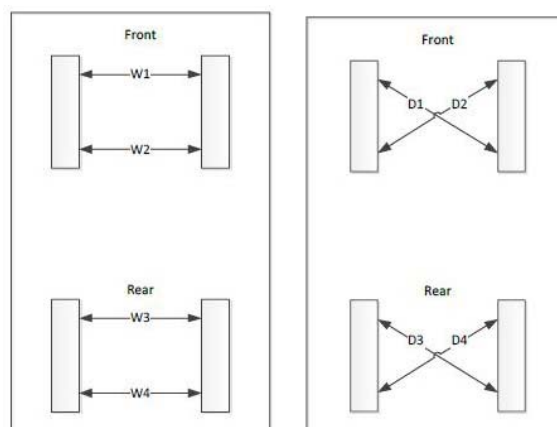

9. Continue to cycle between Steps 5-6 and 7-8 until the width measurements match and the diagonal measurements match. Then and only then are the wheels parallel to each other and the frame.

*NOTE: To achieve this, both conditions must be met.*

***NOTE: The front steering cylinders must both be centered before proceeding!***

10. Set both cylinders to center by measuring 7.64” (19.4 cm) (as shown in the following photo).

The position sensors should both read 4.4” (11.2 cm) when the cylinders are centered and in phase.

**This is not required for All-Wheel Steer (AWS) machines, as the cylinder position sensors can be used to center the cylinders.**

- *The cylinder sensors must be calibrated for this position to be accurate.*
- *If the cylinders do not center at this measurement, they are not in phase. To re-phase the cylinders, turn the steering wheel so that one cylinder is fully retracted and the other is fully extended. Turn the steering wheel at least one full turn past this point. Re-center the cylinders. If the measurements still do not match, repeat the cylinder air bleed procedure.*

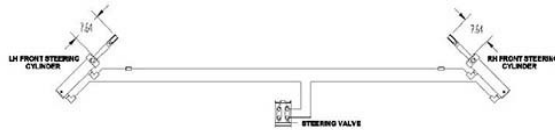

11. With the cylinders centered, adjust the tie-rods (located on the cylinder rods) until they line up with the bolt-down hole (located on the lower air bag plate).
12. Turn the tie-rod one more full turn to achieve desired amount of toe-in.
  - *When the rod ends are turned the final turn (to establish the desired amount of toe-in), the rod ends turn in opposite directions to get each wheel in toe.*
  - *If the amount of threads showing on the left and right rod ends differ by more than four (4) threads, repeat previous Steps 1-12. If the difference remains, there may be a tolerance issue in the leg assembly.*
13. Pry wheel in to allow rod end securing bolt to be inserted.
14. Insert the bolt and secure main bolt and cylinder jam nut to the proper torque specification.

### Rear Wheels

*NOTE: Rear wheels should be set to 0.0” (0.0 cm) toe in/out.*

15. Repeat previous Steps 1-9.
16. **(Non-AWS Machines)** - Set tie rod assembly to match up with the bolt-down hole (located on the lower air bag plate). Insert bolt and secure to the proper torque specification.
17. **(AWS Machines)** - Repeat Step 10, centering the rear cylinders at 4.4” (11.2 cm). Insert bolt and secure main bolt and cylinder jam nut to the proper torque specification.

*NOTE: The cylinder sensors must be calibrated for this position to be accurate.*

- *The machine should be driven and toe (front and rear) rechecked.*
- *Front steering cylinders must be in phase when toe setting is checked.*
- *Failure to hold toe setting could indicate the presence of air in the cylinders.*
- *Repeat the cylinder bleeding procedure, if necessary.*

### Further Information

Contact Hagie Customer Support if additional assistance is needed.

---



---

## SERVICE - MISCELLANEOUS

### Air Bag Pressure

The Air Bags (one located on each leg) automatically adjust pressure to compensate for load weight and field conditions.

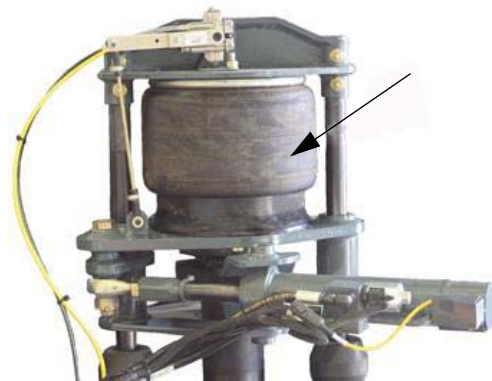

Air Bag  
(One located on each leg)  
-Typical View

The system includes an Air Dryer (located beneath right-hand side of machine) that dries air coming from the air compressor before sending it to a collection tank.

- Inspect the Air Dryer cartridge every 50 hours of operation to ensure that it is purging with compressor load. Change the cartridge every 1,000 hours of operation, or as needed.



Air Dryer  
(Located beneath right-hand  
side of machine)  
-Typical View

From the collection tank, air is sent to the Air Bags as needed to maintain a level pressure. Control Valves open and close to allow air in.

- Inspect Air Bags daily for leaks and/or cracking. If an Air Bag is low, check the bag for any punctures or leaks.

Contact Hagie Customer Support if assistance is needed.

### Air Tank

- Drain the Air Tank daily by slowly releasing the Air Tank Drain Valve (located beneath catwalk on left-hand side of machine).



Air Tank Drain Valve  
(Located beneath catwalk  
on left-hand side of machine)  
\* **Pull DOWN to open**  
-Typical View

- Check for moisture. If excessive moisture is in the tank, there may be a system malfunction.

Contact Hagie Customer Support if assistance is needed.

### Wet Tank

- Drain the Wet Tank daily by slowly releasing the Wet Tank Drain Valve (located beneath catwalk on left-hand side of machine) to prevent system condensation from contaminating the engine air compressor or dryer.



Wet Tank Drain Valve  
(Located beneath catwalk  
on left-hand side of machine)  
\* **Pull DOWN to open**  
-Typical View

### Tire Pressure

 **CAUTION**

When inflating tire, use an extension with an in-line air gauge and attach air chuck. This will allow the operator to stand clear of tire sidewall explosion trajectory.

- Check tire pressure weekly.
- Never inflate a tire more than the recommended maximum air pressure.
- Use an airline with a locking air chuck and stand behind the tire tread while filling.



-Typical View

*NOTE: Tire pressure will depend on type of tire used and amount of load in the solution tank.*

### Tall Corn Machines

#### -If Equipped

If your machine is equipped with the Tall Corn option, perform the following steps to access the tire valve stem:

1. Using a 5/32" hex wrench, remove the button-head screw (located on the wheel access panel) and set aside.
2. Using a 7/16" socket wrench, loosen the hex bolt (located on the wheel access panel) and allow panel to hang loose.

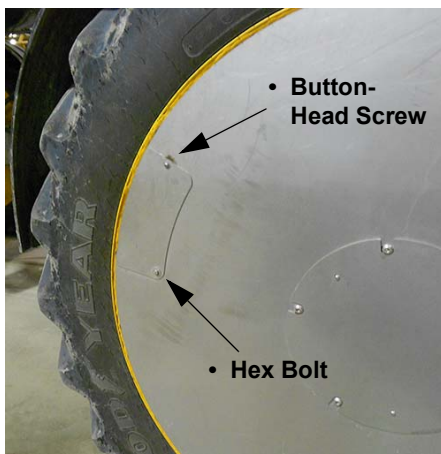

-Typical View



-Typical View

3. Check tire pressure and inflate as desired.
4. Reverse steps to reinstall wheel access panel.

### Nozzle Diaphragms

At the beginning of each season, remove each nozzle body cap (A) and inspect the diaphragm (B) for wear or fit. Replace diaphragms every 1,000 hours of operation, or as necessary.

### Spray Tips



At the beginning of each season (or as required), remove a random sample of spray tip caps (C) and inspect the nozzle tips. If the tips are plugged or worn, clean or replace them. Replace spray tips every 1,000 hours of operation.



Nozzle Diaphragms and Spray Tips  
-Typical View

## 120/132-ft. Spray Booms

### Friction Plates

#### NOTICE

Replace friction plates immediately if damaged. Failure to comply may cause the boom to “catch” during roll functions and result in system damage.

The Friction Plates (located in the bottom corners between the fixed transom and the pivot transom) require daily inspection for uneven wear and other damage.



Friction Plate  
(Located in the bottom corners between  
the fixed transom and pivot transom)  
-Typical View

### Norac® Sensor Foam Pads

Inspect the Norac Sensor Foam Pads daily. Remove the foam pad from each sensor, blow out with compressed air, and reinstall.

*NOTE: Ensure foam pads are clean and dry to ensure optimal performance.*

*NOTE: DO NOT blow the foam pad out while still installed on the sensor. Always remove foam pad before cleaning to avoid sensor damage.*

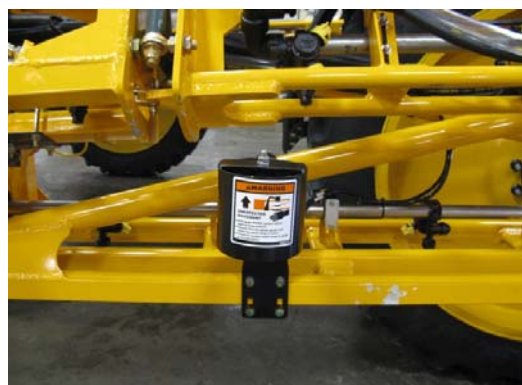

Norac Sensor Foam Pad  
(Located on each Norac sensor)  
-Typical View

Replace foam pads as necessary. Contact Hagie Customer Support for replacement.

## Wiper Blade

Do not allow the Wiper Blade to run on a dry windshield, as this will shorten the life of the blade and/or cause scratching on the windshield.

*NOTE: Replace the windshield wiper blade (39"/99 cm) as necessary.*

The Windshield Washer Fluid Spray Nozzle is adjustable. The fluid spray pattern should be inspected at the beginning of each season, and adjusted as necessary.



Windshield Washer Fluid Spray Nozzle  
(Located near top of exterior cab)  
-Typical View

## Washing the Machine

Wash the machine daily to remove any harmful chemical residue, which can be corrosive to paint and steel.

*NOTE: Always wash machine thoroughly after applying liquid nitrogen.*

As often as possible, thoroughly wash the machine and apply paint to any place where the paint is light or missing.

For replacement decals or touch-up paint recommendations, contact the Hagie Customer Support department.



SERVICE INTERVALS

| Service Point   | Initial | Daily/<br>Before<br>Each<br>Use | As<br>Required | 50<br>Hrs. | 100<br>Hrs. | 250<br>Hrs. ** | 500<br>Hrs. ** | 1000<br>Hrs. |
|---|---------|---------------------------------|----------------|------------|-------------|----------------|----------------|--------------|
| Check Lug Nut Torque                                  | X       |                                 |                |            |             |                |                |              |
| Check Engine Oil Level                                |         | X                               |                |            |             |                |                |              |
| Check Radiator Coolant Level                          |         | X                               |                |            |             |                |                |              |
| Check Radiator Grille Screen                          |         | X                               |                |            |             |                |                |              |
| Check Engine Drive Belt                               |         | X                               |                |            |             |                |                |              |
| Check A/C Compressor Belt                             |         | X                               |                |            |             |                |                |              |
| Check Filter Minder® Level                            |         | X                               |                |            |             |                |                |              |
| Check Hydraulic Reservoir Level                       |         | X                               |                |            |             |                |                |              |
| Check Solution Line Strainer                          |         | X                               |                |            |             |                |                |              |
| Check Batteries                                       |         | X                               |                |            |             |                |                |              |
| Check for Leaks Around the Machine                    |         | X                               |                |            |             |                |                |              |
| Drain Wet Tank/Air Tank                               |         | X                               |                |            |             |                |                |              |
| Check Windshield Washer Fluid Level                   |         | X                               |                |            |             |                |                |              |
| Wash Machine Clean of Chemical Residues               |         | X                               |                |            |             |                |                |              |
| Check and Drain Primary Fuel Filter (Water Separator) |         | X                               |                |            |             |                |                |              |
| Check Air Bags  |         | X                               |                |            |             |                |                |              |
| Grease Boom Fold Lubrication Zerks (90/100')          |         | X                               |                |            |             |                |                |              |
| Grease Boom Breakaway Lubrication Zerk (90/100')      |         | X                               |                |            |             |                |                |              |
| Grease Leg Lubrication Zerks                          |         |                                 | X              |            |             |                |                |              |
| Check Hydraulic Fill Screen                           |         |                                 | X              |            |             |                |                |              |
| Replace Windshield Wiper Blades                       |         |                                 | X              |            |             |                |                |              |
| Fill Windshield Washer Fluid Reservoir                |         |                                 | X              |            |             |                |                |              |





SECTION 8 –  
MAINTENANCE AND STORAGE

| Service Point   | Initial | Before Each Use | As Required | 50 Hrs. | 100 Hrs. | 250 Hrs. ** | 500 Hrs. ** | 1000 Hrs. |
|---|---------|-----------------|-------------|---------|----------|-------------|-------------|-----------|
| Clean Radiator Grille Screen                              |         |                 | X           |         |          |             |             |           |
| Change Engine Drive Belt                                  |         |                 | X           |         |          |             |             |           |
| Change A/C Compressor Belt                                |         |                 | X           |         |          |             |             |           |
| Charge A/C Compressor *                                   |         |                 | X           |         |          |             |             |           |
| Change Air Intake Filter (Filter Minder)                  |         |                 | X           |         |          |             |             |           |
| Change Solution Line Strainer                             |         |                 | X           |         |          |             |             |           |
| Check Spray Nozzle Diaphragms and Tips                    |         |                 | X           |         |          |             |             |           |
| Change Tread Adjustment Bearing Torque                    |         |                 | X           |         |          |             |             |           |
| Change Batteries  |         |                 | X           |         |          |             |             |           |
| Change or Replace Fuses and Breakers                      |         |                 | X           |         |          |             |             |           |
| Replace Fresh Air (Paper) Cab Filter                      |         |                 | X           |         |          |             |             |           |
| Replace Charcoal Cab Filter                               |         |                 | X           |         |          |             |             |           |
| Check Tire Pressure                                       |         |                 | X           |         |          |             |             |           |
| Clean/Replace Rinse Tank Strainer                         |         |                 | X           |         |          |             |             |           |
| Check/Clean Hydraulic Suction Strainer                    |         |                 | X           |         |          |             |             |           |
| Check/Clean Hydraulic Cooling Fan Grille                  |         |                 | X           |         |          |             |             |           |
| Grease Air Bag Collar Zerk                                |         |                 |             | X       |          |             |             |           |
| Check Lug Nut Torque                                      |         |                 |             | X       |          |             |             |           |
| Grease Ladder Pivot Tube Lubrication Zerk                 |         |                 |             | X       |          |             |             |           |
| Grease Boom Transom Pivot Tube Lubrication Zerk (90/100') |         |                 |             | X       |          |             |             |           |
| Change Wheel Hub Oil (Break-in)                           |         |                 |             | X       |          |             |             |           |
| Clean Fresh Air (Paper) Cab Filter                        |         |                 |             | X       |          |             |             |           |
| Check Air Dryer Cartridge                                 |         |                 |             | X       |          |             |             |           |

SECTION 8 –  
MAINTENANCE AND STORAGE



| Service Point                                       | Initial | Before Each Use | As Required | 50 Hrs. | 100 Hrs. | 250 Hrs. ** | 500 Hrs. ** | 1000 Hrs. |
|---|---------|-----------------|-------------|---------|----------|-------------|-------------|-----------|
| Check Tread Adjust Bearing Bolts (Visually)         |         |                 |             | X       |          |             |             |           |
| Check Wheel Hub Oil Level                           |         |                 |             |         | X        |             |             |           |
| Clean Batteries                                     |         |                 |             |         | X        |             |             |           |
| Check Tread Adjust Bearing Bolt Torque              |         |                 |             |         | X        |             |             |           |
| Change Wheel Hub Oil                                |         |                 |             |         |          | X           |             |           |
| Change Engine Oil Filter                            |         |                 |             |         |          | X           |             |           |
| Change Engine Oil                                   |         |                 |             |         |          | X           |             |           |
| Change Primary Fuel Filter (Water Separator)        |         |                 |             |         |          |             | X           |           |
| Change Secondary Fuel Filter                        |         |                 |             |         |          |             | X           |           |
| Change Diesel Engine Coolant Filter                 |         |                 |             |         |          |             | X           |           |
| Change Hydraulic Return Filter                      |         |                 |             |         |          |             | X           |           |
| Check Radiator Coolant Concentration                |         |                 |             |         |          |             | X           |           |
| Change Hydraulic Reservoir Oil                      |         |                 |             |         |          |             |             | X         |
| Change Radiator Coolant                             |         |                 |             |         |          |             |             | X         |
| Change Air Dryer Cartridge                          |         |                 |             |         |          |             |             | X         |
| Change Spray Nozzle Diaphragms and Tips             |         |                 |             |         |          |             |             | X         |
| Grease Internal Components of Reversible Fan        |         |                 |             |         |          |             |             | X         |
| Exhaust Brake Service (contact engine manufacturer) |         |                 |             |         |          |             |             | X         |

\* Use proper equipment.

\*\* 250-500 hours OR yearly, whichever comes first.



| Inspection Point                               | Action (if necessary)                  |
|--|--|
| Engine Oil Level                               | Add Oil                                |
| Radiator Coolant Level                         | Add Antifreeze Solution                |
| Engine Drive Belt                              | Replace Belt                           |
| Filter Minder                                  | Replace Air Filter Element/Reset Gauge |
| Hydraulic Reservoir Oil Level                  | Add Hydraulic Oil/Repair Leaks         |
| Solution Line Strainer                         | Remove and Clean                       |
| Batteries                                      | Clean and/or Tighten                   |
| Radiator Grille Screen                         | Clean                                  |
| Look for Loose or Missing Items (e.g. shields) | Tighten or Replace                     |
| Look for any Fluid Leaks on Machine or Ground  | Determine Cause and Correct            |
| Fuel/Water Separator (drain)                   | See “Service: Filters”                 |
| Wet Tank/Air Tank (drain)                      | See “Service: Miscellaneous”           |

| 120/132' Spray Boom Service Intervals   |       |        |             |             |
|---|-------|--------|-------------|-------------|
| Service Point                           | Daily | Weekly | As Required | 500 Hours** |
| Grease Roller Mount Assembly Zerks      | X     |        |             |             |
| Inspect/Clean Norac® Sensor Foam Pads   | X     |        |             |             |
| Inspect Friction Plates (for wear)      | X     |        |             |             |
| Grease Pendulum Zerks                   | X     |        |             |             |
| Grease Level Pin Adapter Plate Zerks    |       | X      |             |             |
| Replace Norac Sensor Foam Pads          |       |        | X           |             |
| Replace Worn Friction Plates            |       |        | X           |             |
| Grease Transom Pivot Zerks              |       |        | X           |             |
| Grease Pivot Transom Ball Joints        |       |        | X           |             |
| Grease Boom Adapter Zerks               |       |        | X           |             |
| Grease Boom Fold Linkage Zerks          |       |        | X           |             |
| Replace Norac Manifold Hydraulic Filter |       |        |             | X           |



---

---

## STORAGE

### Preparing For Storage

1. Perform daily level checks, lubrication, and bolt/linkage inspections, as required in this manual.
2. Every other season, drain the coolant from the engine and radiator. Probe the drain holes during drainage to ensure they are not clogged by sludge, scale, or other deposits.  
Fill the cooling system to the top with a 50/50 water/antifreeze mixture. Run the engine to operating temperature and recheck level.
3. Add a fuel stabilizer to the fuel and fill the tank.
4. Run the engine until it reaches operating temperature, then drain the engine oil. Refill with fresh oil of recommended weight and install a new lubricating oil filter element.
5. With the engine at normal operating temperature, cycle all hydraulic functions, including the steering.
6. Release tension on all belts.
7. Use plastic bags and water-resistant adhesive tape to seal the air intake opening, all exhaust manifold openings, engine oil filter cap, hydraulic oil tank breather cap, and fuel tank caps.

*NOTE: If the spray boom will be stored separately from the machine, ensure all boom hole openings are capped or covered with a suitable covering.*

8. Disconnect and remove batteries. Completely clean and charge the batteries. Coat the terminals with dielectric grease and store the batteries in a cool place (above freezing).
9. Thoroughly wash the machine and its attachments. Touch up any painted surfaces that are scratched or chipped.

*NOTE: For paint touch-up recommendations, contact the Hagie Customer Support department.*

10. Replace worn or missing decals. Refer to “Safety Decals” in the *Safety and Precautions Section* for proper location of warning decals and corresponding part number.

*NOTE: For decal replacement, contact the Hagie Customer Support department.*

11. Apply multi-purpose grease to coat exposed hydraulic cylinder rods.
12. Refer to the spray system console manufacturer’s operation manual for detailed information on storage procedures for the console and flow meters.
13. If the machine must be stored outside, cover with a waterproof cover.

### Winterization

To winterize the spray system, it is recommended that you use an environmentally safe type of antifreeze and water mixture that will give you adequate protection to -30 degrees F.

- Drain any remaining solution in the spray system.
- Thoroughly rinse the spray system.
- Run antifreeze/water mixture through the spray system until it comes out all of the boom openings.

Repeat process for both the Foam Marker and Rinse Systems.

### Removing From Storage

#### NOTICE

Protective compounds such as grease can harden under exposure to weather conditions. Be sure to remove any dried grease and reapply new, if necessary.

1. Inspect the condition of and test the air pressure of all tires.
2. Carefully unseal all openings that were previously sealed in the “Preparing for Storage” process.

3. Clean and reinstall the batteries. Be sure to attach the battery cables to the proper terminals.
4. Tighten all belts. Inspect and replace any worn belts.
5. Check the engine oil, hydraulic oil, and engine coolant levels, and add if necessary.

*NOTE: A mixture of 50/50 water/antifreeze will cool adequately in the summer, as well as protect in winter.*

6. Thoroughly clean the machine and it's attachments.
7. Perform all recommended services as instructed elsewhere in this section.
8. Attach the spray boom and manually cycle all of the hydraulic functions 2 or 3 times to thoroughly lubricate the components. Test the Norac® system and all of it's functions according to the manufacturer's operation manual.
9. For starting instructions, refer to "Engine - Starting" provided in the *Engine and Drive Systems Section* elsewhere in this manual.

## SECTION 9 – MISCELLANEOUS

### TRANSPORTING

When driving on a public roadway or elsewhere, be aware of any situation where the machine will be passing under an object with a clearance lower than the transporting height of the machine.

#### CAUTION

Hagie Manufacturing Company does not recommend any form of transportation other than driving the sprayer. Loading the sprayer onto a trailer may result in sprayer rollover.

#### WARNING

- Never operate the sprayer on a public roadway with solution in the tank.
- Never load or unload the sprayer with solution in the tank.
- Stopping the sprayer on trailer ramps may result in the sprayer to tip over.

#### CAUTION

DO NOT operate the machine at speeds exceeding 20 mph (32 km/h) with solution in the tank. Operating speeds exceeding 20 mph (32 km/h) with a fully loaded tank may result in tire blow-out or wheel hub damage and will void the warranty.

#### WARNING

When transporting the sprayer, observe the following to avoid serious injury or death:

- Check for adequate clearance before driving under any overhead obstructions.
- Contact with power lines may result in serious injury or death.



#### CAUTION

Do not transport the machine without booms folded and in cradle. Failure to comply may result in injury or equipment damage.

### Cradling the Booms

#### CAUTION

Booms must be in FOLDED position when cradled. Failure to comply will result in property damage.

*NOTE: Always cradle the booms before traveling, transporting, or parking for an extended period of time.*

- Fold outer boom extensions IN.
- Raise transom all the way UP.
- Fold main boom sections IN toward the machine.

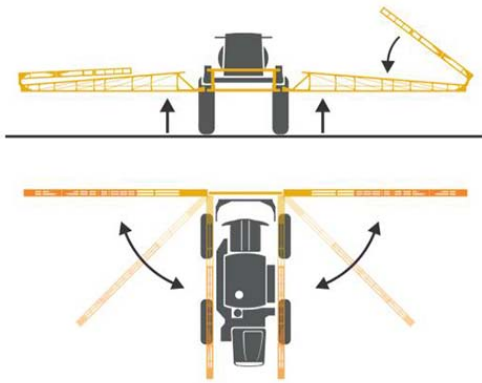

*NOTE: When boom reaches the last 8-10 degrees of travel, it will automatically slow down to avoid impact with the cradle.*

- Raise each individual boom until it clears the outer cradle stop.
- Fold the boom IN toward cradle back-stop.
- When boom touches the back-stop, lower until the full weight of the boom rests in the cradle.



### Driving the Sprayer on a Public Roadway

1. Always have the booms in the folded and cradled position when driving or transporting the machine.
2. Use the flashing Hazard/Warning Lights, day or night to warn other drivers, unless prohibited by law.

3. Know and obey all state laws for driving agricultural equipment on a public roadway.
4. Adjust machine speed to suit the conditions.
5. Slow down and use turn signals before turning.
6. Pull over to the side of the road before stopping.
7. Keep a proper lookout and maintain control of the machine.
8. Do not drive under trees, bridges, wires, or other obstructions unless there is adequate clearance.
9. Use extra care before entering or exiting a public roadway.
10. Ensure the SMV (Slow Moving Vehicle) emblem is properly displayed to warn other drivers, unless prohibited by law.
11. Do not drive the machine at speeds exceeding 20 mph (32 km/h) with solution in the tank. Operating speeds exceeding 20 mph (32 km/h) with a fully loaded tank may result in tire blow-out or wheel hub damage and will void the warranty.

### Loading

#### WARNING

Keep all persons away from trailer when loading or unloading the sprayer. Failure to comply may result in serious injury or death.

#### NOTICE

Read and understand the trailer manufacturer's operation manual. Hitch the trailer to the pulling vehicle according to their recommendations.

## NOTICE

The loaded height and width of the trailer must conform to state law in which it is being used. Do not exceed the trailer manufacturer's recommendations on loaded weight.

1. Pull the trailer to flat ground.
2. Apply the pulling vehicle's parking brake and turn the engine OFF.
3. Use tire chocks to keep the trailer from moving.
4. Fold the booms and lower into cradles.
5. Lower the trailer ramps and set the ramp spacing for the machine's tread width setting.
6. Have an attendant help guide you onto the trailer.
7. Allow enough room between the sprayer and the pulling vehicle for turning.
8. Secure the sprayer onto the trailer using the recommended securement restraints (see trailer manufacturer's operation manual).
9. Cover or remove the SMV (Slow Moving Vehicle) emblem when traveling over 25 mph (40 km/h).

## Unloading

1. Pull the trailer to flat ground.
2. Apply the pulling vehicle's parking brake and turn the engine OFF.
3. Use tire chocks to keep the trailer from moving.
4. Lower the trailer ramps and set the ramp spacing for the machine's tread width setting.
5. Carefully release the securement restraints.
6. Have an attendant help guide you off of the trailer.
7. Uncover or replace the SMV (Slow Moving Vehicle) emblem.

## Towing

## NOTICE

Sprayer should never be towed under any circumstances. Machine damage will occur and will void the power train warranty.



Contact Hagie Customer Support if towing is unavoidable.

---

## LIFTING POINTS

## ⚠ CAUTION

Use extreme caution when supporting machine by a lifting point. Failure to obtain proper location and lifting equipment may cause the machine to become unstable.

## NOTICE

Lift machine on hard level surface with properly rated equipment only.

There are four (4) designated lifting points on the machine. These points are located on the frame near each leg and are equipped with containment rings for safe jack location.



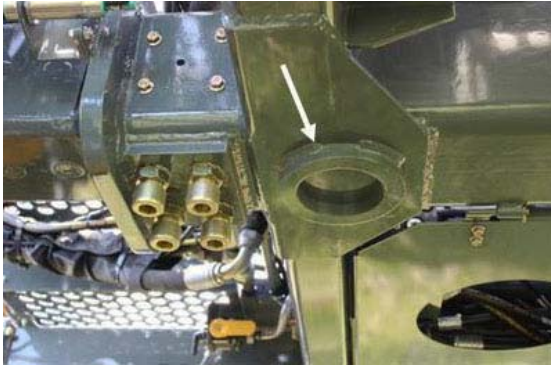

Lifting Point Containment Rings  
(Located on the frame near each leg)  
-Typical View

**⚠ WARNING**

When connecting or disconnecting the booms, observe the following safety precautions:

- Monitor both sides of the boom during fold procedure.
- Select a safe area before unfolding/folding the booms.
- Clear area of personnel.
- Check for overhead obstructions.
- Do not unfold or fold booms near power lines. Contact with power lines can result in serious injury or death.

QUICK-TACH SYSTEM -  
SPRAY BOOMS

**⚠ CAUTION**

When operating or positioning the booms, observe the following safety precautions. Failure to comply may result in injury or equipment damage.

- Do not unfold/fold boom extensions when main boom is in cradle.
- Do not operate machine with one boom out of cradle and the other boom in cradle. Ensure booms are folded and in cradle before transporting the machine.



**⚠ WARNING**

Turn the engine OFF before connecting/disconnecting any hoses or electrical lines. Failure to comply may result in serious injury or death.

**Connecting the Boom**

1. Square up to the boom.

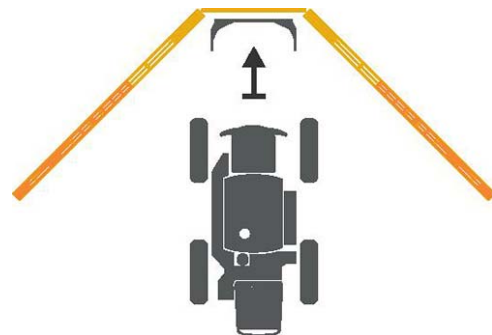

2. Disengage the Quick-Tach Lock Assemblies by pulling the Lock Pins (located

on the front left and right-hand side of machine) OUT as far as it will go until it is in the “lock-out” position.

*NOTE: “Lock-out” position prevents re-locking while attaching or detaching the attachment.*

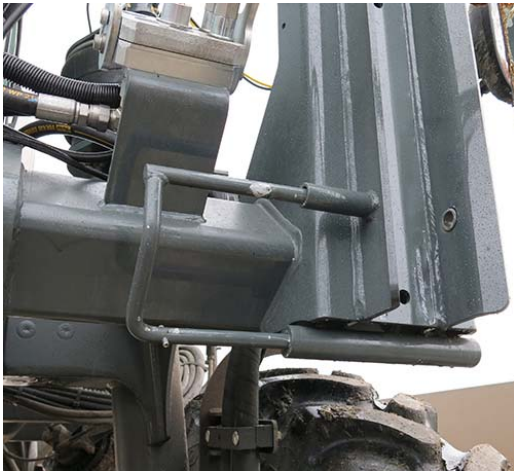

Lock Pin  
(Located on the front left and  
right-hand side of machine)  
-Typical View

*\* Disengaged position shown*

3. Lower the machine by deflating the Air Bags.

*NOTE: Refer to “Air Suspension Exhaust” elsewhere in this section for further information.*

4. Slowly pull into the attachment.
5. Ensure the Attachment Hooks are high enough to clear the Mounting Pins.



Attachment Clearing Mounting Pin  
-Typical View

6. Engage the parking brake.
7. **Turn the engine OFF before connecting any hoses or electrical lines!**
8. Connect all Solution, Foam Marker (if equipped), Hydraulic, and Electrical Connections.

### Solution Connection



Solution Connection  
(Located on the front  
right-hand side of machine)  
-Typical View

### Foam Marker Connection

-If Equipped



Foam Marker Connection  
(Located on the front  
right-hand side of machine)  
-Typical View

### Hydraulic Connections



Hydraulic Connections  
(Located on front left-hand side of machine)  
-Typical View

- Remove caps from machine and boom hydraulic connections. Connect hydraulic hoses together and tighten.

### Electrical Connections



Electrical Connections  
(Located on front right-hand side of machine)  
-Typical View

- Install the Electrical Connections (located on the right-hand side of boom) into the Electrical Ports (located on the right-hand side of machine).

*NOTE: Turn Electrical Connections “clockwise” to engage.*

9. Rotate the NORAC Hand Valve - *if equipped* (located on the left and right-hand level cylinders) in the OPEN (counter-clockwise) position.

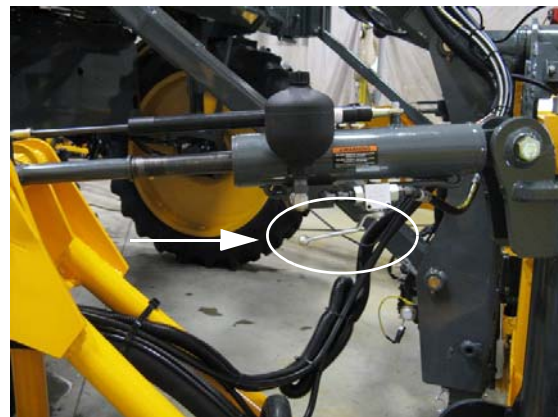

NORAC Hand Valve (2) - *if equipped*  
(Located on the left and  
right-hand level cylinders)  
-Typical View

*\* Right-hand level cylinder shown*

10. Start the engine.
11. Raise the machine by inflating the air bags.

*NOTE: Refer to “Air Suspension Exhaust” elsewhere in this section for further information.*

12. Raise the boom until the Attachment Hooks fully engage.

*NOTE: Raising the attachment will allow the weight of the boom to pull the Attachment Hooks over the Mounting Pins. You will notice a change of weight as the machine begins to support the attachment.*

13. Engage the Quick-Tach Lock Assemblies by pushing the Lock Pins IN, ensuring full engagement.

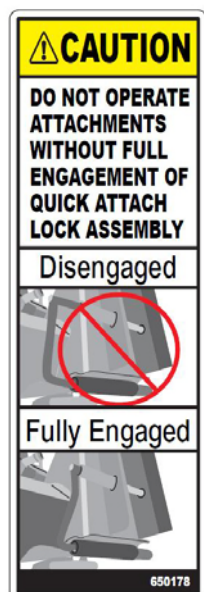

Lock Pin  
-Typical View

*\* Engaged position shown*

14. Place the Boom Stands (if equipped) in the TRAVEL position by removing the securement pin and sliding the leg all the way UP.

*NOTE: Reinsert the securement pin (located above the bracket) to keep the leg in the travel position.*

NOTICE

Do not operate the boom while the boom stands are in the lowered position. Failure to comply may result in property damage.



Boom Stand in Travel Position  
-Typical View

## Disconnecting the Boom

Before disconnecting the boom, determine a proper storage location. When choosing a place to store the boom, there are three important things to keep in mind:

### Is the ground level?

The ground must be level to help prevent the attachment from falling over. Level ground will also minimize stress on the frame of the attachment when in storage.

### Is there enough space?

The attachment needs to be partially open for it to stand properly, but be aware of the room that is needed for the attachment and adequate space to travel around it safely.

**Is it accessible?**

The attachment needs to be positioned so you can connect easily. Ensure there is enough room and that the attachment is not blocked, or blocking other items.

If temporarily storing the attachment on a soft surface (such as grass), it is recommended to place blocks or wood beneath the stand's feet to prevent the attachment from sinking into the ground.

*NOTE: It is NOT recommended to store the attachment on a soft surface for an extended period of time, due to the risk of settling soil, even when blocks or wood are used.*

1. Press and hold the corresponding Left and Right Boom Switches (located on the Hydrostatic Drive Control Handle) in the UP position to remove boom wings from cradles.



Left and Right Boom Switches  
(Located on the Hydrostatic  
Drive Control Handle)  
-Typical View

2. Press and hold the corresponding Left and Right Boom Switches in the OUT position to unfold the boom wings until partially open.

*NOTE: Booms only need to be unfolded far enough to be able to lower. They do NOT need to be fully extended.*

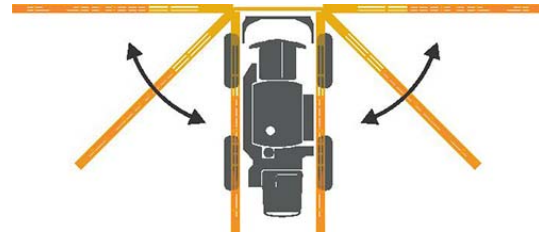

-Typical View

3. Press and hold the corresponding Left and Right Boom Switches in the DOWN position to point boom tips down.
4. Lower the boom and secure the boom stands (if equipped) in the DOWN position.

|   |
|---|
| <h2>NOTICE</h2>   |
| Lower boom to the ground before disengaging the Quick-Tach Lock Assemblies. |

5. Disengage the Quick-Tach Lock Assemblies by pulling the Lock Pins (located on the front left and right-hand side of machine) OUT as far as it will go until it is in the “lock-out” position.

*NOTE: “Lock-out” position prevents re-locking while attaching or detaching the attachment.*



Lock Pin  
(Located on the front left and  
right-hand side of machine)  
-Typical View

*\* Disengaged position shown*

6. Lower the machine by deflating the Air Bags.

*NOTE: Refer to “Air Suspension Exhaust” elsewhere in this section for further information.*

7. Ensure the Boom Solution Valve Switches (located on the side console) are in the OFF position.



Boom Solution Valve Switches  
(Located on the side console)  
-Typical View

8. Disconnect the Solution and Foam Marker Connections (if equipped), ensuring not to leave the ends in an area where they may become damaged or contaminated.

### Solution Connection



Solution Connection  
(Located on the front  
right-hand side of machine)  
-Typical View

### Foam Marker Connection

-If Equipped

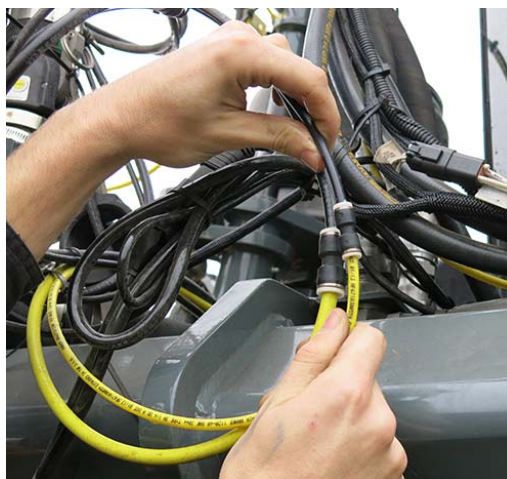

Foam Marker Connection  
(Located on the front  
right-hand side of machine)  
-Typical View

9. Press the Transom Switch (located on the Hydrostatic Drive Control Handle) in the DOWN position and slowly lower the boom/transom assembly until Attachment Hooks have cleared the Mounting Pins.



Transom Switch  
(Located on the Hydrostatic  
Drive Control Handle)  
-Typical View

*NOTE: A “bounce back” effect may be felt when the weight of the boom has been relieved from the machine. Once the airbags have cycled, the machine will adjust to the new weight.*

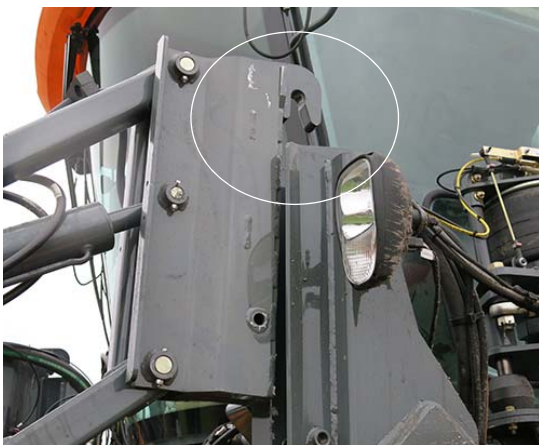

Attachment Clearing Mounting Pin  
-Typical View

10. Engage the parking brake.
11. **Ensure the engine is turned OFF before disconnecting any hoses or electrical lines!**
12. Disconnect the Hydraulic/Electrical Connections (located on the front left and

right-hand side of machine), ensuring not to leave the ends in an area where they may become damaged or contaminated.

### Hydraulic Connections



Hydraulic Connections  
(Located on front left-hand side of machine)  
-Typical View

- Disconnect hydraulic hoses. Reinstall caps onto machine and boom hydraulic connections (if no other attachment will be installed).

*NOTE: Contact Hagie Customer Support for replacement caps.*

## NOTICE

Ensure caps are reinstalled onto hydraulic connections before starting the machine (if no other attachment will be installed). Failure to comply will result in hydraulic oil to eject from connection points and possible hydraulic system contamination.

## Electrical Connection



Electrical Connections  
(Located on front right-hand side of machine)  
-Typical View

- Remove the Electrical Connections (located on the right-hand side of boom) from the Electrical Ports (located on the right-hand side of machine).

*NOTE: Turn Electrical Connections “counter-clockwise” to disengage.*

13. Rotate the NORAC Hand Valve - *if equipped* (located on the left and right-hand level cylinders) in the CLOSED (clockwise) position.

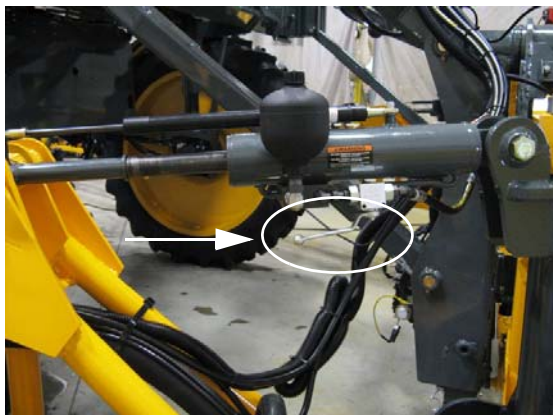

NORAC Hand Valve (2) - *if equipped*  
(Located on the left and right-hand level cylinders)  
-Typical View

*\* Right-hand level cylinder shown*

14. If no other attachment is going to be installed, re-lock the Quick-Tach Lock Assemblies by pushing the Lock Pins IN.

15. Start the machine.
16. Disengage the parking brake and slowly back away from the boom.
17. Raise the machine by inflating the air bags.

*NOTE: Refer to “Air Suspension Exhaust” provided elsewhere in this section for further information.*

## Boom Stands

### 90' Spray Booms

#### -If Equipped

If your boom is equipped with boom stands, there will be two (2) located on the transom and one (1) located on each of the inner boom sections.

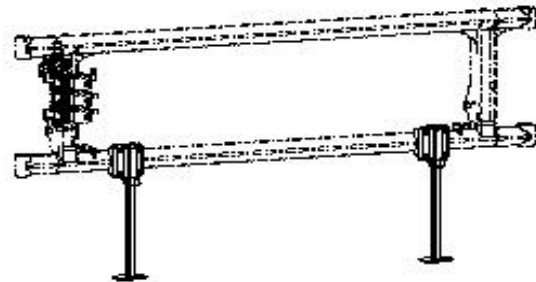

Booms Stands  
(90' Boom)  
-Typical View

Each boom stand has a leg with a “foot” on the bottom and a hex bolt in the top hole of the leg to secure it from sliding off, as well as a “snap” lock pin in the hole (located directly below the bracket) to maintain its position.



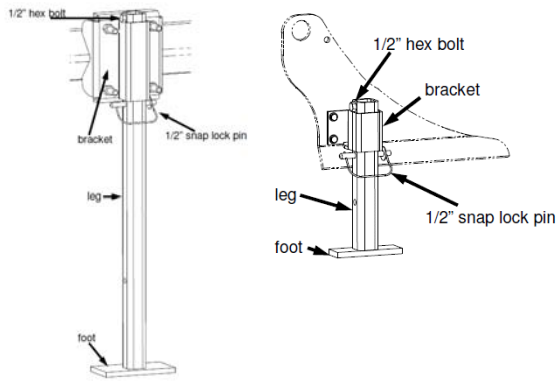

Boom Stand Assembly  
-Typical View



Lock Pin  
(Located on the outer  
side of transom frame)  
-Typical View

### 120/132' Spray Booms

Your boom is featured with two (2) boom stands (located on the transom).

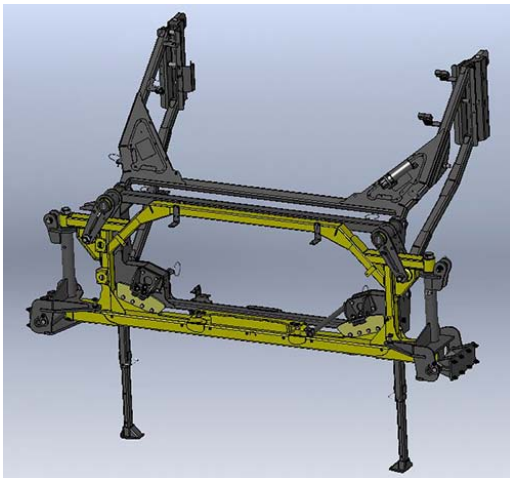

Booms Stands  
(120/132' Boom)  
-Typical View

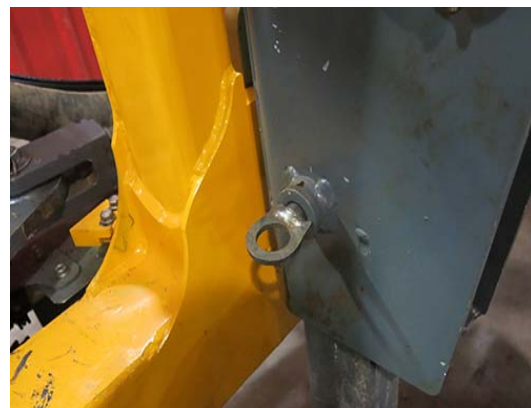

Lock Pin Removed  
-Typical View

### To Extend Booms Stands:

1. Remove Lock Pin (located on the outer side of transom frame) and set aside.

2. While supporting the bottom “foot” end of boom stand, remove the Mounting Bolt (located on the outer side of transom frame) and slowly lower boom stand to desired position.



**Mounting Bolt**  
(Located on the outer  
side of transom frame)  
-Typical View

3. With the boom stand at desired position, reinstall the Mounting Bolt, ensuring the holes of the boom stand and transom frame are properly aligned.



**Boom Stand**  
(Extended position shown)  
-Typical View

4. Reinstall Lock Pin (that was previously removed in Step 1).
5. Repeat Steps 1-4 on opposite side of boom.

*NOTE: For additional adjustment, the “foot” end of the boom stand may also be adjusted to best suit your*

*situation (e.g. boom height, ground level, etc.) Adjust in the same manner as previously described.*

6. Reverse steps to store booms stands in “travel” position.

### Unfolding the Boom for Storage

The booms must be partially open for stability when unattached from the machine. Unfold the booms approximately 45 degrees while maintaining sufficient clearance for repositioning during reattachment. This position will allow the booms to sit level with the transom without causing excessive stress on either part. It will also keep the weight from shifting too much in either direction (rearward or forward), which could cause the boom to tip over and/or difficulty in connecting or disconnecting the attachment.

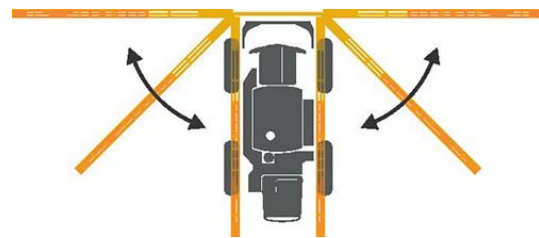

-Typical View

---



---

## AIR SUSPENSION EXHAUST

The Air Suspension Exhaust system is used to manually or automatically exhaust/inflate the air suspension on your machine, providing you with a smooth, consistent ride quality.

### Air Suspension Exhaust Components

- Dump Valve (4)
- Pilot Valve
- MD3 Monitor



Dump Valve  
(One valve located on each leg)  
-Typical View



Pilot Valve  
(Located beneath catwalk  
on left-hand side of machine)  
-Typical View



MD3 Monitor  
-Typical View



- Press the F4 “Dump Air Bag” Button (located on the MD3 Monitor). Hold the F4 Button until the “Dump Air Bag” display (located on the bottom right-hand side of display screen) turns “green”, indicating that the air suspension is fully exhausted. See Figure B.



### Inflating the Air Suspension (Manually)

- Press the Down Arrow Button (located on the right-hand side of the MD3 Monitor) to navigate to the Machine Hours Page. See Figure C.

### Exhausting the Air Suspension (Manually)

- Press the Down Arrow Button (located on the right-hand side of the MD3 Monitor) to navigate to the Machine Hours Page. See Figure A.



- Press the F4 “Dump Air Bag” Button (located on the MD3 Monitor). Hold the F4 Button until the “Dump Air Bag” display (located on the bottom right-hand side of display screen) turns “white”, indicating that the air suspension is fully inflated. See Figure D.



## Exhausting/Inflating Air Suspension (Automatically)

### Exhausting Air Suspension

- With the ignition key in the OFF position, turn the Pilot Valve (located beneath catwalk on left-hand side of machine) to the OFF position.

*NOTE: When the ignition key is in the ON position, the air suspension will inflate.*

### Inflating Air Suspension

- Turn the Pilot Valve to the ON position to inflate air suspension, regardless of ignition key position.



Pilot Valve  
(Located beneath catwalk on left-hand side of machine)  
-Typical View

## HAND WASH SYSTEM

# CAUTION

The Hand Wash System is not a substitute for Personal Protective Equipment (PPE). Always use the proper PPE (safety eye wear, face shields, protective clothing, etc.) when handling agricultural chemicals.

# NOTICE

Keep hand wash tank full of fresh water at all times for immediate use should contact with hazardous chemicals occur.

# NOTICE

Fill hand wash tank with fresh water only.

- Fill the Hand Wash Tank with fresh water.



Hand Wash Tank  
(Located near cab door)  
-Typical View

- Turn the Hand Wash Valve (located beneath left-hand side of machine) “counter-clockwise” to the ON position.

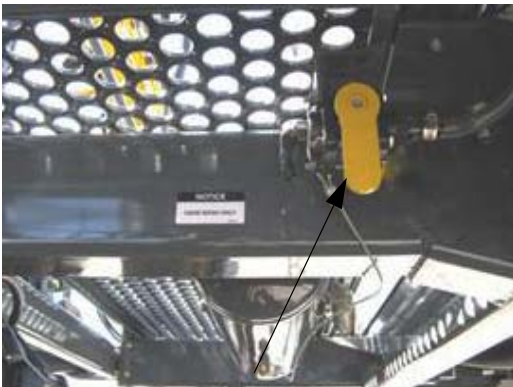

Hand Wash Valve  
(Located beneath left-hand side of machine)  
-Typical View

*NOTE: Close the Hand Wash Valve before refilling the tank.*

---

## TALL CORN PACKAGE - INSTALLATION

### - If Equipped

*NOTE: Ensure correct Belly Shield configuration before installing.*

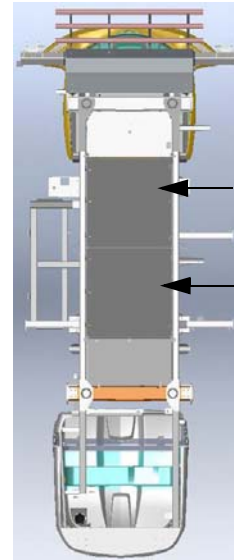

Belly Shield Installation  
-Typical View

*\* View shown from bottom side of machine*

*NOTE: Two persons are required when installing the Tall Corn Package.*

### Installing Belly Shields

1. Install Securement Pin Assembly (Hanger Pin and Securement Pin) onto each Retaining Bracket (located along frame).

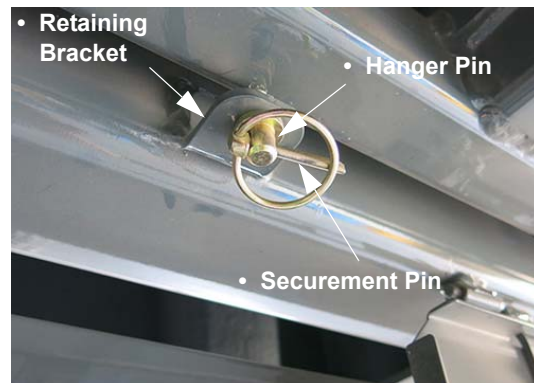

Retaining Bracket/  
Securement Pin Assembly  
-Typical View

2. Starting with Panel 1, install Support Hook Assemblies into the corresponding Hinge Bushings (located along frame).
3. Install Cotter Pin onto the end of each support hook.

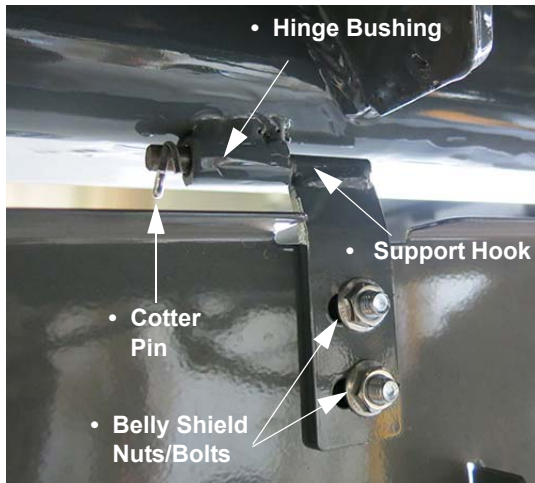

-Typical View

*NOTE: Ensure belly shield nuts and bolts are loose.*

4. On opposite side of machine, remove previously installed Securement Pins (from Hanger Pins).
5. Lift panel and align hole openings with Hanger Pins. Attach by reinserting the Securement Pins.

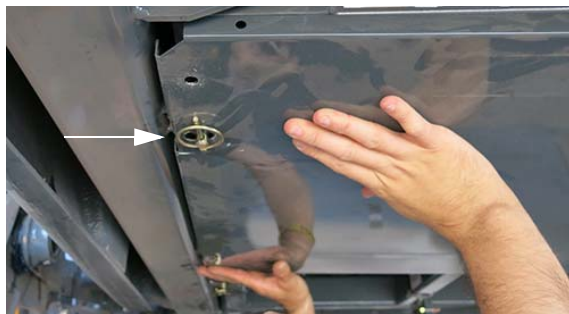

Securement Pin  
(Installed into Hanger Pin)  
-Typical View

6. Using a 1/2" wrench or socket, tighten the belly shield nuts and bolts, as shown.



-Typical View

7. Repeat previous steps to install Panel 2.

### Installing Front Brush Guard

1. Remove the two (2) Mounting Bolts - front and rear (located on the right-hand cross member hose assembly mounting bracket).



Mounting Bolts (2) - Front/Rear  
(Located on the right-hand cross member  
hose assembly mounting bracket)  
-Typical View  
*\*Rear bolt shown*

2. Insert two (2) Mounting Bracket Spacers to the bottom of the front and rear bracket assembly, as shown in the following photo.
3. Install two (2) new Mounting Bolts and Washers through the top of the front and rear of bracket assembly, as shown in the following photo.

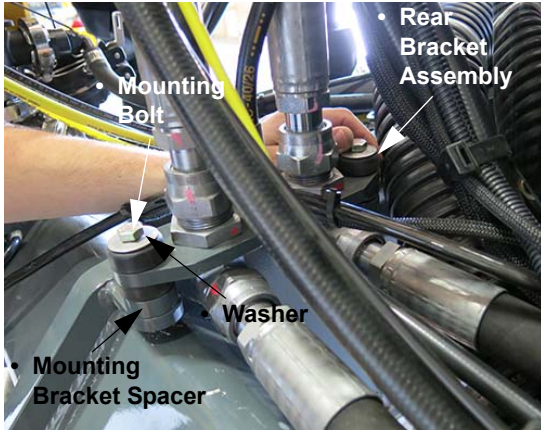

-Typical View

4. Install Brush Guard Mounting Bracket between right-hand cross member and hose assembly, as shown.



Brush Guard Mounting Bracket  
(Right-hand side of machine shown)  
-Typical View

5. Install nut to the bottom of each Mounting Bracket and tighten using a 9/16" wrench.

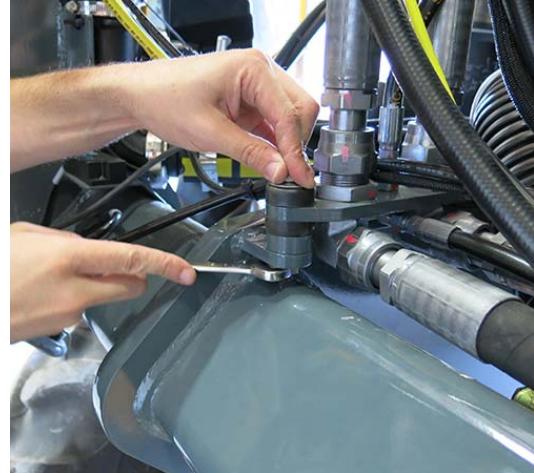

-Typical View

6. Install additional Brush Guard Mounting Bracket on left-hand cross member, as shown.



Brush Guard Mounting Bracket  
(Left-hand side of machine shown)  
-Typical View

7. Assemble Mounting Bracket Hardware (bracket, hanger pin, and bolt) together.

*NOTE: Ensure the hanger pin hole opening is facing toward the length of the bracket.*

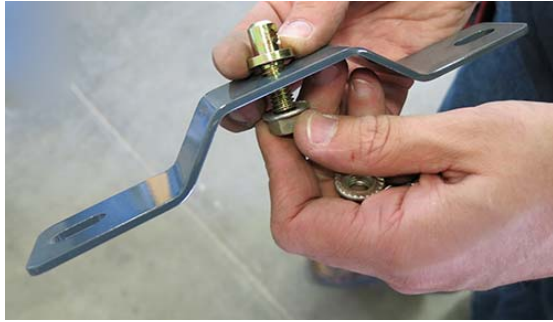

Mounting Bracket Hardware  
-Typical View

8. Attach Brush Guard Rail to left-hand cross member by installing 4” Anchor Bolts through the top and bottom of the Mounting Bracket Hardware, and securing to the previously installed Brush Guard Mounting Bracket.

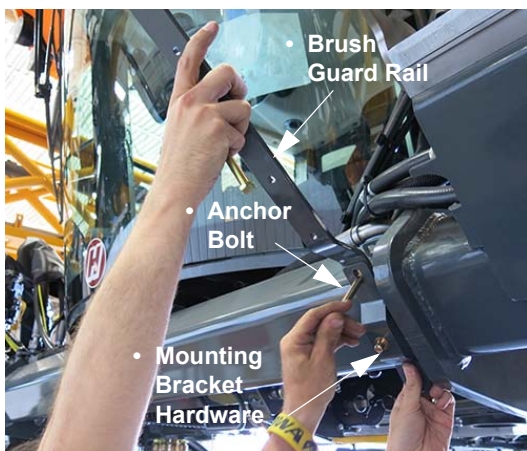

Brush Guard Rail Assembly  
-Typical View



Anchor Bolt Assembly  
-Typical View

9. Repeat Step 8 to install Brush Guard Rail to right-hand cross member.

*NOTE: The outer left and right-hand Brush Guard Rails must be installed prior to the center rails.*

10. Install each center Brush Guard Rail by attaching with Rail Support and two (2) 7 1/2” Anchor Bolts, as shown.

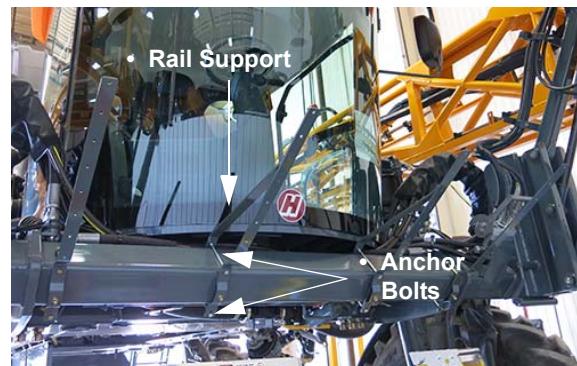

Center Brush Guard Rail Assembly  
-Typical View

11. Fasten each center Brush Guard Rail and Rail Support together using a 5/16” x 1” bolt, as shown in the following photo. Tighten bolt with a 9/16” wrench.



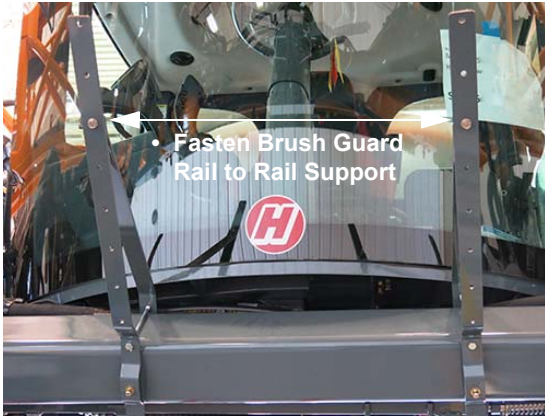

-Typical View

12. Using a tape measure, ensure the distance from the outer edge of the right and left-hand cross member support tube to the inner edge of the hanger pin (of the outer Brush Guard Rail) is 2 1/2" (6.4 cm), as shown in the following photo.

*NOTE: If needed, use a rubber mallet to obtain proper distance.*



-Typical View

13. Once proper distance is achieved, hand-tighten top and bottom Anchor Bolts on each side.



-Typical View

14. Using a tape measure, ensure the distance from the outer edge of the right and left-hand cross member support tube to the inner edge of the hanger pin (of the center Brush Guard Rail) is 24" (61 cm), as shown in the following photo.

*NOTE: If needed, use a rubber mallet to obtain proper distance.*



-Typical View

15. Repeat Step 15 on opposite side, ensuring 24" (61 cm) distance.
16. Once proper distance is achieved, hand-tighten top and bottom Anchor Bolts of each center Brush Guard Rail.



-Typical View

17. If necessary, remove the Front Fill Valve Bolt (using a 1/2" wrench) and set aside.

*NOTE: If Front Fill Valve is already oriented correctly, proceed to Step 23.*

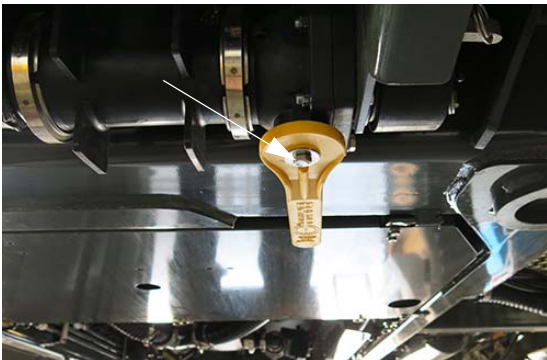

Front Fill Valve Bolt  
-Typical View

18. Rotate the Front Fill Valve 180° (valve handle facing toward front of machine) and reinstall bolt.



-Typical View

19. Lower Front Fill Assembly.  
20. Using a 5/16" wrench, loosen the two (2) Front Fill Manifold Clamps.



Front Fill Manifold Clamps  
-Typical View

21. Rotate center fill assembly UP to allow valve clearance, as shown.



-Typical View

22. Re-tighten the Front Fill Manifold Clamps and raise Front Fill Assembly to stored position.
23. Starting at the bottom, install Brush Guard Tubes to Brush Guard Rails, securing with U-Bolts and tightening with a 1/2” wrench.

*NOTE: Ensure U-Bolts are not over-tightened. If the bolts are snugged too tight, the brush guard extensions will not extend properly.*

*NOTE: Ensure the Brush Guard Adjustment Clips located on each end of tube are facing upward when installing.*

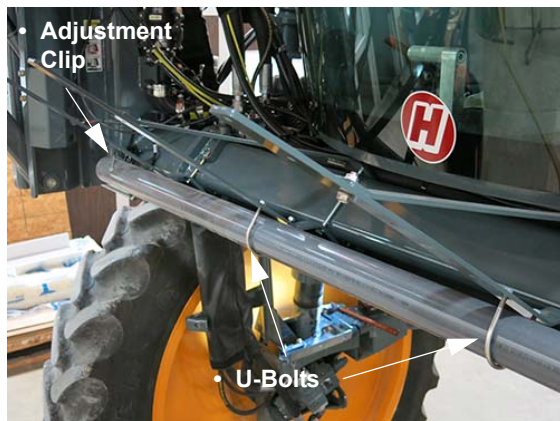

Brush Guard Tube  
-Typical View

24. Repeat process for remaining brush guards.



Brush Guard Installation  
-Typical View

### Brush Guard Extension

- Remove adjustment clip from pin (located on the end of each brush guard tube).
- Extend tube to desired position, ensuring hole openings align.
- Reinstall adjustment clip to pin.



Brush Guard Adjustment Clip  
(Located on the end of each tube)  
-Typical View

### Installing Front Shield

1. Pre-assemble support hook and bolts to the Front Shield (one side only) and hand-tighten with a 1/2” wrench, as shown in the following photo.
2. Install support hook into the corresponding hinge bushing (located beneath the front end of machine near tread adjust bolts).

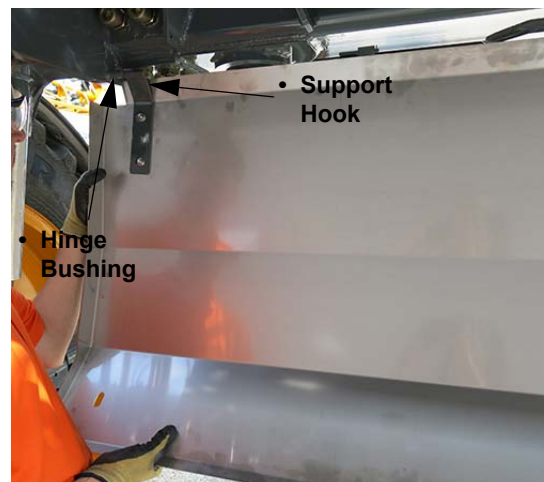

-Typical View

3. Install support hook into hinge bushing on opposite side of machine (without bolts and nuts).
4. Lift Front Shield and install bolts through back side of panel and support hook. Hand-tighten with a 1/2" wrench.



-Typical View

5. Lift Front Shield and install the four (4) Securement Pins into the previously installed hanger pins (located on front of machine).

*NOTE: Brush Guard Rails may require adjustment to ensure proper alignment of the Front Shield.*



Front Shield Installation  
-Typical View

### Installing Crop Dividers

1. Install two (2) black caps (located on each end of the four Crop Dividers).

2. Remove the three (3) Leg Mounting Bolts and set aside.
3. Slide Crop Divider Mounting Plate beneath leg plate, as shown in the following photo.

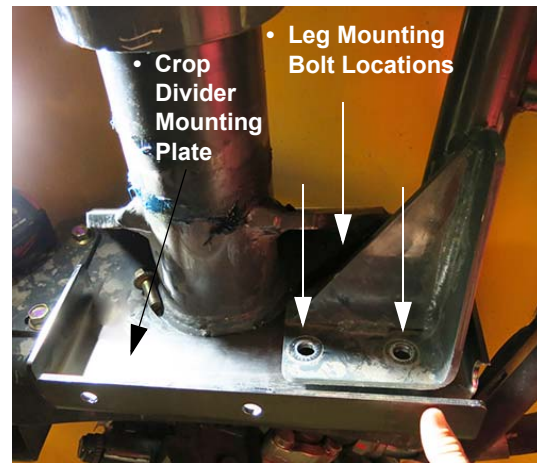

-Typical View

4. Align Leg Mounting Bolt and Crop Divider Mounting Plate holes and reinstall previously removed bolts, tightening with a 3/4" wrench or socket.
5. Install additional Mounting Plate Bolt, as shown in the following photo. Tighten with a 3/4" wrench or socket.



Mounting Plate Bolt  
-Typical View

6. Slide Crop Divider into mounting plate, as shown.

*NOTE: Ensure the hook end of the Crop Divider is facing outward.*



Installed Crop Divider  
-Typical View

7. Install two (2) Crop Divider Mounting Bolts through Crop Divider mounting plate and tube. Tighten with a 3/4" wrench or socket.



Crop Divider Mounting Bolt  
-Typical View

8. Repeat steps to install remaining Crop Dividers.

### Installing Wheel Covers

#### NOTICE

Remove two (2) lug nuts at a time from the wheel bolts when installing the hub cap adapter plates.

1. Remove two (2) lug nuts from two (2) of the wheel bolts and set aside.

2. Install Hub Cap Adapter Plate onto the two bolts, as shown in the following photo.
3. Reinstall the two lug nuts onto bolts and tighten to with a 30 mm air wrench. Refer to “Service: Bolt Torque” provided in the *Maintenance and Storage Section* elsewhere in this manual for further information.



Hub Cap Adapter Plate  
-Typical View

4. Perform Steps 1-3 to install remaining adapter plates, ensuring only two (2) lug nuts are removed from the wheel bolts at one time.



-Typical View

5. Install the Hub Cap Adapter Weldment onto the outside of the previously installed Hub Cap Adapter Plates.

*NOTE: Ensure the Hub Cap Adapter Weldment is flush with the face of the wheel hub.*



Hub Cap Adapter Weldment  
-Typical View

6. Install 1/2" bolt through the hub cap adapter assembly. Install nut to bolt and tighten with a 3/4" wrench.

*NOTE: Repeat for each adapter assembly location around the wheel hub.*



Hub Cap Adapter Bolt Installation  
-Typical View

7. Install Wheel Cover onto the hub cap adapter assembly.

*NOTE: Ensure the rectangular cut-out on the wheel cover is aligned with the tire valve stem, as shown.*



-Typical View



-Typical View

8. Install 1/2" mounting bolt through the front of wheel cover and Hub Cap Adapter Weldment mounting holes.

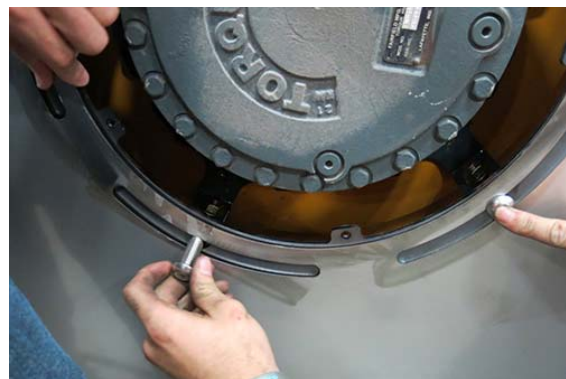

Wheel Cover Mounting Bolt Installation  
-Typical View

9. Install nut to mounting bolt and tighten with a 5/16” hex wrench.

*NOTE: Repeat for each adapter assembly location around the wheel hub.*

10. Install Valve Stem Access Panel to the Wheel Cover.
11. Install a 1/4” bolt through the access panel and wheel cover. Install nut to bolt and tighten with a 3/8” wrench.

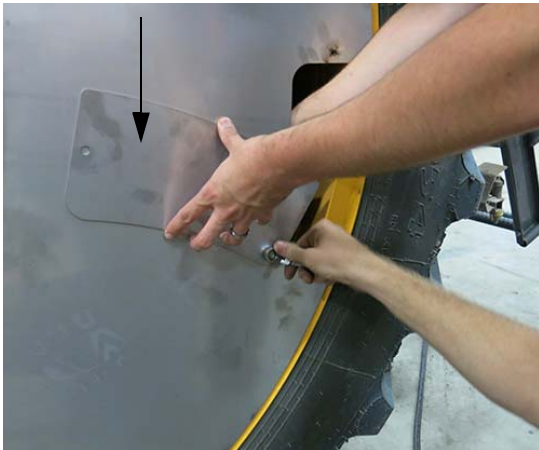

Valve Stem Access Panel  
-Typical View

12. With hole openings aligned, install remaining 1/4” bolt (tighten with 3/8” wrench) and nut (tighten with 7/16” wrench).
13. Install Hub Cap Access Panel to center of wheel cover, ensuring the hole openings of each are properly aligned.



Hub Cap Access Panel  
-Typical View

14. Install 1/4” bolt through access panel and wheel cover, tightening with a 3/8” wrench.
15. Wheel cover installation complete.



Wheel Cover Installation  
-Typical View

## TROUBLESHOOTING

| Problem                                   | Possible Cause  | Suggested Remedy  |
|---|---|---|
| Engine will not crank                     | <ul style="list-style-type: none"> <li>• Dead battery</li> <li>• Poor battery connections</li> <li>• Starter or starter relay</li> <li>• Blown fuse in engine electric box</li> <li>• Battery Disconnect Switch in OFF position</li> </ul>    | <ul style="list-style-type: none"> <li>• Recharge or replace battery</li> <li>• Clean and tighten</li> <li>• Test (rebuild or replace)</li> <li>• Check fuse</li> <li>• Turn Battery Disconnect Switch to ON position</li> </ul>  |
| Engine will not start                     | <ul style="list-style-type: none"> <li>• Out of fuel</li> <li>• Clogged fuel filter</li> <li>• Cold weather</li> <li>• Low starter speed</li> <li>• Blown fuse in engine electric box</li> </ul>  | <ul style="list-style-type: none"> <li>• Fill fuel tank</li> <li>• Replace fuel filters</li> <li>• Refer to the engine manufacturer's operation manual for cold weather starting</li> <li>• Check starter and battery</li> <li>• Check fuse</li> </ul>                            |
| Engine overheats                          | <ul style="list-style-type: none"> <li>• Engine overload</li> <li>• Dirty radiator core/grille screen</li> <li>• Faulty radiator cap</li> <li>• Loose or faulty fan belt</li> <li>• Faulty thermostat</li> <li>• Low coolant level</li> </ul> | <ul style="list-style-type: none"> <li>• Reduce load</li> <li>• Remove all foreign material and clean all items</li> <li>• Replace cap</li> <li>• Tighten or replace fan belt</li> <li>• Replace thermostat</li> <li>• Refill to proper level with recommended coolant</li> </ul> |
| Engine misfires:<br>runs uneven/low power | <ul style="list-style-type: none"> <li>• Water in fuel</li> <li>• Dirty air cleaner element</li> <li>• Poor grade of fuel</li> <li>• Fuel tank vent clogged</li> <li>• Clogged fuel filter</li> </ul>   | <ul style="list-style-type: none"> <li>• Drain, flush, replace filter, fill system</li> <li>• Replace element</li> <li>• Drain system, change to a better grade fuel</li> <li>• Open fuel tank vent (in cap)</li> <li>• Replace fuel filter</li> </ul>                            |
| Engine knocks                             | <ul style="list-style-type: none"> <li>• Low oil level in crankcase</li> <li>• Cold engine</li> </ul>   | <ul style="list-style-type: none"> <li>• Add oil to full mark</li> <li>• Allow proper warm-up period, refer to engine manufacturer's operation manual</li> </ul>  |
|   |   |   |
| Solution pump will not prime              | <ul style="list-style-type: none"> <li>• Low water level in pump</li> <li>• Air leak in suction line</li> <li>• Solution tank valve closed</li> </ul>   | <ul style="list-style-type: none"> <li>• Ensure the solution tank is not empty (solution pump is self-priming)</li> <li>• Inspect and tighten all fittings on suction line</li> <li>• Open solution tank valve, allow air to leave the system</li> </ul>                          |





SECTION 9 –  
MISCELLANEOUS

|  |  |  |
|--|--|--|
| <p>Erratic reading on pressure gauge</p>           | <ul style="list-style-type: none"> <li>• Orifice in back of gauge clogged</li> <li>• Faulty gauge</li> <li>• Air leak in suction line</li> <li>• Solution strainers plugged</li> <li>• Glycerin leaking from gauge</li> </ul>  | <ul style="list-style-type: none"> <li>• Remove gauge, clean orifice, reinstall</li> <li>• Replace gauge</li> <li>• Inspect and tighten all fittings in suction line</li> <li>• Check solution strainers</li> <li>• Replace gauge</li> </ul>   |
| <p>Malfunction of electric solution valve</p>      | <ul style="list-style-type: none"> <li>• Faulty ground</li> <li>• Dirty contact terminals</li> <li>• Separation in wire</li> <li>• Faulty switch</li> <li>• Short in solenoid coil</li> <li>• Bad valve</li> </ul>   | <ul style="list-style-type: none"> <li>• Clean and tighten ground</li> <li>• Clean contact terminals</li> <li>• Check continuity and replace wire</li> <li>• Replace switch</li> <li>• Replace valve</li> </ul>  |
| <p>Solution pump not producing normal pressure</p> | <ul style="list-style-type: none"> <li>• Clogged line strainer screen</li> <li>• Air leak in suction flow to pump</li> <li>• Restricted solution flow to pump</li> <li>• Suction hose collapsed</li> <li>• Internal restriction of diaphragm (such as buildup of chemical)</li> <li>• Hydraulic failure</li> </ul> | <ul style="list-style-type: none"> <li>• Remove screen, clean thoroughly, tighten strainer cap to avoid air leak</li> <li>• Inspect and tighten all fittings on suction line</li> <li>• Main Solution Tank Shutoff Valve not open completely</li> <li>• Obstruction at inlet end of hose, causing high vacuum on hose</li> <li>• Disassemble, inspect, clean, reassemble</li> <li>• Contact Hagie Customer Support for assistance</li> </ul> |
|  |  |  |
| <p>Machine will not move in either direction</p>   | <ul style="list-style-type: none"> <li>• Speed control is set too low</li> <li>• Engine speed too low</li> <li>• Oil level in reservoir too low</li> <li>• Clogged filter</li> <li>• Hydrostatic System failure</li> </ul>   | <ul style="list-style-type: none"> <li>• Adjust the setting of the Speed Control Dial</li> <li>• Set engine at operating RPM before trying to move machine</li> <li>• Fill reservoir to proper level with approved oil (see Service: Fluids elsewhere in this section)</li> <li>• Replace filter</li> <li>• Contact Hagie Customer Support for assistance</li> </ul>   |
| <p>Machine will move in only one direction</p>     | <ul style="list-style-type: none"> <li>• Speed control is set too low</li> <li>• Hydrostatic System failure</li> </ul>   | <ul style="list-style-type: none"> <li>• Adjust the setting of the Speed Control Dial</li> <li>• Contact Hagie Customer Support for assistance</li> </ul>  |



|  |   |   |
|--|---|---|
| <p>Hydrostatic System responding slowly</p>      | <ul style="list-style-type: none"> <li>• Engine speed too low</li> <li>• Oil in reservoir low</li> <li>• Cold oil</li> <li>• Plugged filter</li> <li>• Partially restricted suction line</li> <li>• Hydrostatic System failure</li> </ul> | <ul style="list-style-type: none"> <li>• Set engine at operating RPM before trying to move the machine</li> <li>• Fill reservoir to proper level with approved oil (see Service: Fluids elsewhere in this section)</li> <li>• Allow adequate warm-up period</li> <li>• Check and replace filter</li> <li>• Inspect for collapsed suction hose</li> <li>• Contact Hagie Customer Support for assistance</li> </ul> |
| <p>Noisy Hydrostatic System</p>                  | <ul style="list-style-type: none"> <li>• Cold oil</li> <li>• Low engine speed</li> <li>• Oil level in reservoir low</li> <li>• Hydrostatic System failure</li> </ul>  | <ul style="list-style-type: none"> <li>• Allow adequate warm-up period</li> <li>• Increase engine speed</li> <li>• Fill reservoir to proper level with approved oil (see Service: Fluids elsewhere in this section)</li> <li>• Contact Hagie Customer Support for assistance</li> </ul>   |
| <p>Entire hydraulic system fails to function</p> | <ul style="list-style-type: none"> <li>• Oil level in reservoir too low</li> <li>• Auxiliary hydraulic system failure</li> </ul>  | <ul style="list-style-type: none"> <li>• Fill reservoir to proper level with approved oil (see Service: Fluids elsewhere in this section)</li> <li>• Contact Hagie Customer Support for assistance</li> </ul>   |



|   |  |   |
|---|--|---|
| Noisy hydraulic pump  | <ul style="list-style-type: none"><li>• Oil level in reservoir too low</li><li>• Auxiliary hydraulic system failure</li></ul>  | <ul style="list-style-type: none"><li>• Fill reservoir to proper level with approved oil (see Service: Fluids elsewhere in this section)</li><li>• Contact Hagie Customer Support for assistance</li></ul>  |
| AWS System will not turn on   | <ul style="list-style-type: none"><li>• AWS Switch not on</li><li>• Machine not in Field Mode</li><li>• Machine not in first speed range</li><li>• Sensor or valve malfunction</li></ul>                           | <ul style="list-style-type: none"><li>• Turn AWS Switch ON</li><li>• Bring machine to the NEUTRAL position and place in Field Mode</li><li>• Machine speed below AWS shutoff gear</li><li>• Contact Hagie Customer Support for assistance</li></ul> |
| AWS System is ON, but rear tires do not follow behind the front tires | <ul style="list-style-type: none"><li>• Machine is being shifted out of the first speed range before turn is complete</li><li>• Sensor or valve malfunction</li></ul>  | <ul style="list-style-type: none"><li>• This is left up to the operator's discretion</li><li>• Contact Hagie Customer Support for assistance</li></ul>  |
| AWS System does not work, machine will only move at slow speed        | <ul style="list-style-type: none"><li>• Operator see sensor malfunction message</li></ul>  | <ul style="list-style-type: none"><li>• Contact Hagie Customer Support for assistance</li></ul>   |
| Entire electrical system is dead                                      | <ul style="list-style-type: none"><li>• Dead battery</li><li>• Poor battery connection</li><li>• Low charging rate</li><li>• No charging rate</li><li>• Battery Disconnect Switch is in the OFF position</li></ul> | <ul style="list-style-type: none"><li>• Replace battery</li><li>• Clean and tighten battery connections</li><li>• Tighten alternator belt</li><li>• Replace alternator</li><li>• Turn Battery Disconnect Switch ON</li></ul>                        |
| Light system does not function  | <ul style="list-style-type: none"><li>• Poor ground</li><li>• Burned out bulb</li><li>• Separation or short in wire</li><li>• Blown fuse</li><li>• Faulty switch</li><li>• Ignition switch is OFF</li></ul>        | <ul style="list-style-type: none"><li>• Clean and tighten ground</li><li>• Replace bulb</li><li>• Check continuity and replace wire</li><li>• Replace fuse</li><li>• Replace switch</li><li>• Turn ignition switch to the ON position</li></ul>     |



## INDEX

---

|   |      |  |      |
|---|------|--|------|
| 2014 Product Warranty .....               | 1-14 | Service - Toe-In .....                 | 8-16 |
| A Word From Hagie Manufacturing           |      | Service and Assistance .....           | 1-2  |
| Company .....                             | 1-1  | Service Intervals .....                | 8-23 |
| About This Manual .....                   | 1-1  | Solution System - Operation .....      | 7-23 |
| Air Suspension Exhaust .....              | 9-13 | Solution System Components .....       | 7-19 |
| All-Wheel Steer (AWS) .....               | 4-5  | Specifications .....                   | 1-5  |
| Application .....                         | 7-34 | Spray Boom - Rear .....                | 7-18 |
| Batteries .....                           | 6-1  | Spray Booms - 120/132' .....           | 7-7  |
| Battery Disconnect Switch .....           | 6-2  | Spray Booms - 60/80/90/100' .....      | 7-1  |
| Circuit Breakers And Fuses .....          | 6-3  | Storage .....                          | 8-27 |
| Emergency Exit .....                      | 2-7  | Tall Corn Package - Installation ..... | 9-16 |
| Emergency Stop .....                      | 2-6  | Transporting .....                     | 9-1  |
| Engine - Starting .....                   | 4-1  | Tread Adjustment .....                 | 5-5  |
| Fence Row Applicator .....                | 7-31 | Troubleshooting .....                  | 9-27 |
| Filling Your Solution Tank .....          | 7-25 |  |      |
| Foam Marker System .....                  | 7-32 |  |      |
| Hand Wash System .....                    | 9-15 |  |      |
| Hydraulic System Components .....         | 5-1  |  |      |
| Hydrostatic Drive .....                   | 4-2  |  |      |
| Identification .....                      | 1-2  |  |      |
| Ladder .....                              | 5-6  |  |      |
| Lifting Points .....                      | 9-3  |  |      |
| MD3 System .....                          | 3-19 |  |      |
| Operator's Station .....                  | 3-3  |  |      |
| Pressure Washer .....                     | 5-7  |  |      |
| Quick-Tach System - Spray Booms .....     | 9-4  |  |      |
| Reversible Fan .....                      | 5-4  |  |      |
| Rinse System .....                        | 7-29 |  |      |
| Rotating Beacon .....                     | 2-6  |  |      |
| Safety Decals .....                       | 2-7  |  |      |
| Safety Messages Used In This Manual ..... | 1-2  |  |      |
| Safety Precautions .....                  | 2-1  |  |      |
| Seat - Instructor .....                   | 3-3  |  |      |
| Seat - Operator .....                     | 3-1  |  |      |
| Seat - Operator (Premium) .....           | 3-2  |  |      |
| Seat Belt .....                           | 2-6  |  |      |
| Service - Belts .....                     | 8-13 |  |      |
| Service - Bolt Torque .....               | 8-14 |  |      |
| Service - Filters .....                   | 8-5  |  |      |
| Service - Fluids .....                    | 8-1  |  |      |
| Service - Lubrication .....               | 8-9  |  |      |
| Service - Miscellaneous .....             | 8-18 |  |      |

