

CALIFORNIA

Proposition 65 Warning

WARNING: Diesel engine exhaust and some of its constituents are known to the State of California to cause cancer and birth defects or other reproductive harm.

WARNING: Battery posts, terminals, and related accessories contain lead and lead compounds, chemicals known to the State of California to cause cancer and birth defects or other reproductive harm.



ANY PICTURES CONTAINED WITHIN THIS OPERATOR'S MANUAL THAT DEPICT SITUATIONS WITH SHIELDS, GUARDS, RAILS, OR LIDS REMOVED ARE FOR DEMONSTRATION PURPOSES ONLY. HAGIE MANUFACTURING COMPANY STRONGLY URGES THE OPERATOR TO KEEP ALL SHIELDS AND SAFETY DEVICES IN PLACE AT ALL TIMES.



**OPERATOR'S MANUAL
FOR
HAGIE MODEL STS 14 HI-TRACTOR
SPRAYER- DETASSELER**

HAGIE MANUFACTURING COMPANY

721 CENTRAL AVENUE WEST
BOX 273
CLARION, IOWA 50525

(515) 532-2861

COVERS MACHINE SERIAL NUMBERS:U1670880001 thru U1670880100

02-09 493423

© 2007 Hagie Manufacturing Company. Clarion, Iowa USA

ABBREVIATIONS

A/C.....	AIR CONDITIONING	M/F.....	MAINFRAME
ACCUM.....	ACCUMULATOR	MPH.....	MILES PER HOUR
ADJ.....	ADJUST	MT.....	MOUNT
ADPTR.....	ADAPTER	MTH.....	MONTH
ALT.....	ALTERNATOR	MTR.....	MOTOR
AMP.....	AMPERE	NO.....	NUMBER
APPROX.....	APPROXIMATELY	OD.....	OUTSIDE DIAMETER
ASSY.....	ASSEMBLY	PLT.....	PLATE
AUX.....	AUXILIARY	POLY.....	POLYETHYLENE
BRKT.....	BRACKET	PRESS.....	PRESSURE
BTRY.....	BATTERY	PRKNG.....	PARKING
C.....	CELSIUS	PSI.....	POUNDS PER SQUARE INCH
CAL.....	CALIBRATION	QT.....	QUART
CCA.....	COLD CRANKING AMPS	RAD.....	RADIATOR
CHEM.....	CHEMICAL	REC.....	RECOMMENDED
cm.....	CENTIMETER	REQ.....	REQUIRED
CTRL.....	CONTROL	RPM.....	REVOLUTIONS PER MINUTE
CYL.....	CYLINDER	SAE.....	SOCIETY of AUTOMOTIVE ENGINEERS
DIA.....	DIAGRAM	SEC.....	SECOND
DIM.....	DIMENSION	SERV.....	SERVICE
DISPL.....	DISPLACEMENT	SLCTR.....	SELECTOR
EA.....	EACH	SMV.....	SLOW MOVING VEHICLE
ELECT.....	ELECTRIC	SOLE.....	SOLENOID
F.....	FAHRENHEIT	SOLU.....	SOLUTION
FIG.....	FIGURE	SPEC.....	SPECIFICATION
FLO.....	FLOW	STRG.....	STEERING
FRT.....	FRONT	SQ.....	SQUARE
FT.....	FOOT OR FEET	TACH.....	TACHOMETER
GA.....	GAUGE	TEMP.....	TEMPERATURE
GAL.....	GALLON	TERM.....	TERMINAL
GPA.....	GALLONS PER ACRE	TRD.....	TREAD
GPM.....	GALLONS PER MINUTE	TT.....	TUBE-TYPE
GPS.....	GLOBAL POSITIONING SATELLITE	TU.....	TUBELESS
HAL.....	HALOGEN	VAR.....	VARIABLE
HR.....	HOUR	V.....	VOLT
HYD.....	HYDRAULIC	VFC.....	VARIABLE FLOW CONTROL
HYDRO.....	HYDROSTATIC	VLV.....	VALVE
ID.....	INSIDE DIAMETER	W/.....	WITH
IN.....	INCH	W/O.....	WITHOUT
INFO.....	INFORMATION	W.....	WEIGHT
Km/H.....	KILOMETERS PER HOUR	WD.....	WHEEL DRIVE
L.....	LITER (DISPLACEMENT)	WHL.....	WHEEL
l.....	LITER (LIQUID)	WK.....	WEEK
LB.....	POUND	WLD.....	WELDMENT
LS.....	LIGHT SENSOR		
m.....	METER		
MAINT.....	MAINTENANCE		
MIN.....	MINUTE		

TO THE OWNER



A WORD FROM HAGIE MANUFACTURING COMPANY

Congratulations on your selection of a Hagie Model STS 14 SPRAYER/DETASSELER. We recommend that you study this Operator's Manual and become acquainted with the adjustments and operating procedures before attempting to operate your new sprayer. As with any piece of equipment, certain operating procedures, service, and maintenance are required to keep it in top running condition.

We have attempted herein to cover all of the adjustments required to fit varying conditions. However, there may be times when special care must be considered.

Hagie Manufacturing Company reserves the right to make changes in the design and material of any subsequent sprayer without obligation to existing units.

We thank you for choosing a Hagie sprayer and assure you of our continued interest in its satisfactory operation for you. If we might be of assistance to you, please call us.

We are proud to have you as a customer.

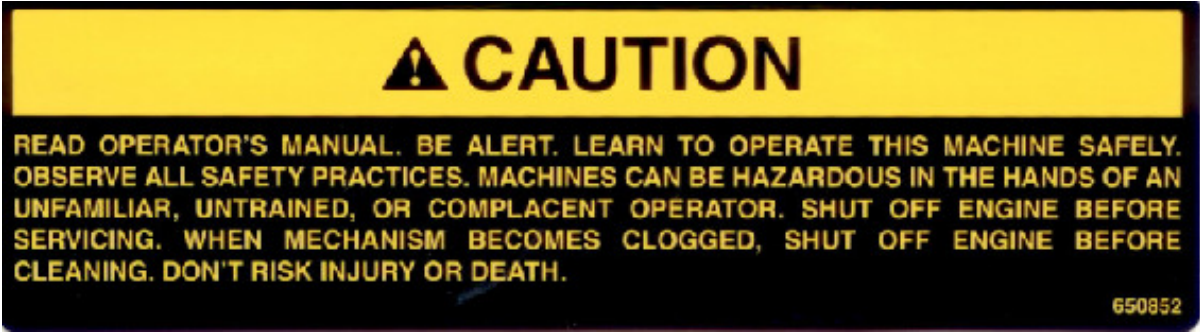

TO THE OPERATOR

The following pages and illustrations will help you operate and service your new sprayer. It is the responsibility of the user to read the Operator's Manual and comply with the safe correct operating procedures and lubricate and maintain the product according to the maintenance schedule.

The user is responsible for inspecting the machine and having parts repaired or replaced when continued use of the product causes damage

or excessive wear to other parts.

Keep this manual in a convenient place for easy reference when problems arise. This manual is considered a permanent fixture with this machine. In the event of resale, this manual should accompany the sprayer. If you do not understand any part of the manual or require additional information or service, contact the Hagie Customer Support Department:

Hagie Manufacturing Company
 721 Central Avenue West
 Box 273
 Clarion, IA 50525-0273
 (515) 532-2861

The following symbols, found throughout this manual, alert you to potentially dangerous conditions to the operator, service personnel, or the equipment.



This symbol indicates a hazardous situation which, if not avoided, will result in death or serious injury.



This symbol indicates a potentially hazardous situation which, if not avoided, could result in death or injury.



This symbol indicates a potentially hazardous situation which, if not avoided, may result in minor or moderate injury. It may also be used to alert against unsafe practices.

I. SAFETY/DECALS

SAFETY PRECAUTIONS

Most accidents occur as the result of failure to follow simple and fundamental safety rules. For this reason, most accidents can be prevented by recognizing the real cause and doing something about it before the accident occurs.

Many conditions cannot be completely safeguarded against without interfering with efficient operation and/or reasonable accessibility. Therefore, you must study this Operator's Manual

and learn how to use the sprayer controls for safe operation. Likewise, do not let anyone operate without instruction.

Do not make modifications such as weldments, add-ons, adaptations, or changes from the original design of sprayer. Such changes and/or modifications may become safety hazards to you and to others and will void all warranties.

DRIVING

- Before moving sprayer, make sure no persons or obstructions are in path of travel.
- Do not permit passengers on sprayer when it is moving; they may fall off or obstruct operator's view.
- Never drive near ditches, embankments, holes, mounds, or other obstacles.
- Never drive on hills too steep for safe operation.
- Always drive at a reasonable field speed.
- Reduce sprayer's speed before turning.
- Come to a complete stop before reversing direction.
- Pull over to side of road before stopping.
- Additional weight caused from partially full or full solution tanks may cause erratic or increased stopping distance.
- Never operate sprayer on roadway with any solution in solution tank.
- Do not activate parking brake while machine is in motion or damage may occur to machine.
- Use flashing/hazard warning lights when traveling on public roads, day or night, unless prohibited by local law.
- Make sure SMV and SIS emblem is in place and visible from rear when traveling on public roads.

I. SAFETY/DECALS

OPERATING

TREAD WIDTH

- Select a tread setting to fit between crop rows.

SPRAYER BOOMS

- Cradle booms when leaving sprayer unattended.
- Make sure booms are folded when cradled.
- Select a safe area before unfolding booms. Avoid power lines and overhead structures.

OUTRIGGERS

- Make sure the outriggers are locked when folded in or folded out.

GENERAL OPERATION SAFETY

- Do not adjust factory engine RPM settings.
- Operate engine at one bump to assure proper charge pressure for brakes to work properly.
- Start engine from operator's seat only. Do not by-pass safety-start switch.
- Never use starting fluid to assist engine start up.
- Never run sprayer engine in a closed building. Proper exhaust ventilation is required.
- If equipped with ground speed sensing radar or light sensing depth units, do not look directly into radar beam. It emits a very low intensity microwave signal which may cause possible eye damage.
- Never allow walking personnel in the same field as a detasseler or sprayer.

I. SAFETY/DECALS

REPAIR/MAINTENANCE

HYDRAULICS

- Use caution when working with hydraulic fluid under pressure. Escaping hydraulic fluid can have sufficient force to penetrate your skin, causing serious injury. This fluid may also be hot enough to burn.
- Always lower load or relieve hydraulic pressure before repairing a hydraulic oil leak.
- Avoid torching, welding, and soldering near pressurized hydraulic lines.

FUELING

- Always turn engine off and allow it to cool before refueling.
- Do not smoke while refueling.
- Do not fill fuel tank completely. Fuel may expand and run over.

GENERAL REPAIR/MAINTENANCE

- Turn off engine before checking, adjusting, repairing, lubricating, or cleaning any part of sprayer.
- When servicing radiator, let engine cool before removing pressurized cap.
- Disconnect battery ground cable and turn main battery switch off before servicing electrical system or welding on machine.
- When charging battery, connect positive cable to positive terminal and negative cable to negative terminal. Failure to do so may result in an explosion and cause injury. Likewise, avoid battery acid contact with body.

I. SAFETY/DECALS

CHEMICAL HANDLING

- Never allow chemicals to come in contact with skin or eyes. Wear protective clothing or respirators as recommended by chemical manufacturer. Store this clothing outside of the cab so as not to contaminate filtered cab environment. Also, clean your boots to remove soil or other contaminated particles prior to entering cab.
- Never pour chemicals into an empty tank, fill tank half full of water first.
- Follow chemical manufacturer's instructions for mixing chemicals.
- Dispose of empty chemical containers properly.
- Wash spilled chemicals or spray residue from sprayer to prevent corrosion and deterioration.
- Select a safe area to fill, flush, calibrate, and clean sprayer where chemicals will not drift or run off to contaminate people, animals, vegetation, or water supply.
- Never place nozzle tips or other parts to one's lips in an attempt to unclog spray tip.
- Do not spray when wind is in excess of chemical manufacturer's recommended speed.
- Store pesticides in their original containers with label intact. Keep them in a separate, locked building.

GENERAL SAFETY

- Keep a fire extinguisher close at all times.
- Keep all shields in place.
- Keep clear of all moving parts and keep others away when operating.
- Do not wear loose fitting clothing that may be blown or drawn into moving parts.

I. SAFETY/ DECALS

WARNING DECALS

Decals warning you of avoidable danger are located on various parts of the sprayer. They are there for your personal safety and protection. DO NOT remove them. They will fracture upon attempted removal and therefore must be replaced.

Following are locations of important safety decals. Replace them if they are torn or missing. All

warning decals and other instructional Hagie decals or machine striping may be purchased through Hagie Customer Support Department. To replace decals, be sure the installation area is clean and dry; decide on exact position before you remove the backing paper.

DECAL LOCATION



650107



Rear of mainframe above booster terminals.



650118



On engine compartment, in front of air intake.

I. SAFETY/ DECALS



650164

Left side rear cab post.



650165

Right side rear cab post.



650174

650174

In engine compartment, on radiator.



I. SAFETY/ DECALS

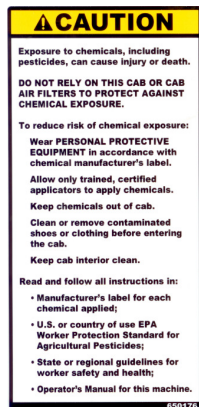

650176

Inside right-hand cab post by rear window.



650178

Quick attach mount.

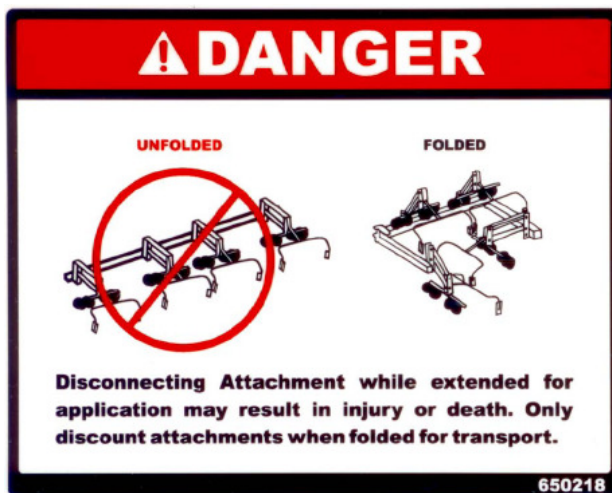

650218

650218

2- 1 each end of the combo attachment.



I. SAFETY/ DECALS

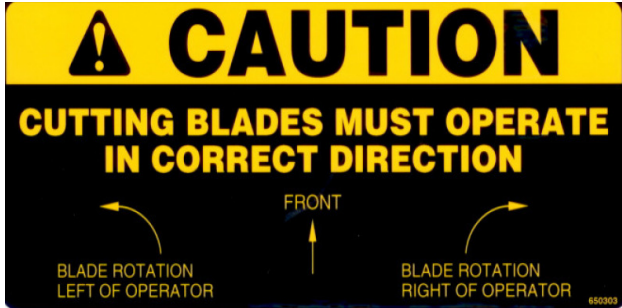

650303

Right side window, rear corner.

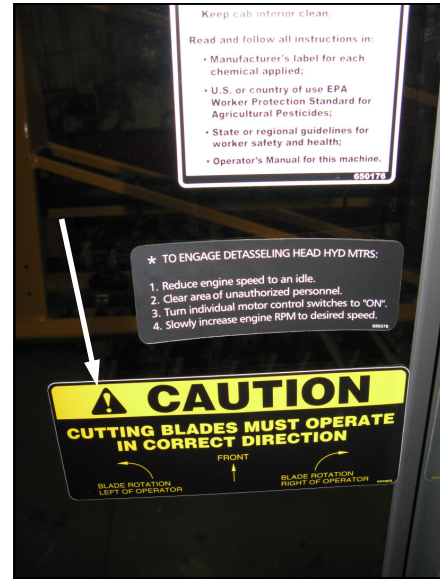

650339

On front cross member, left side (picture 1)

On hydraulic reservoir, to left of sight gauge (picture 2)

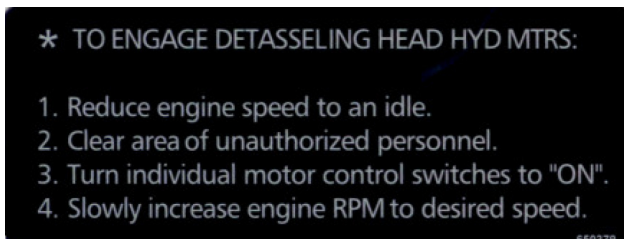
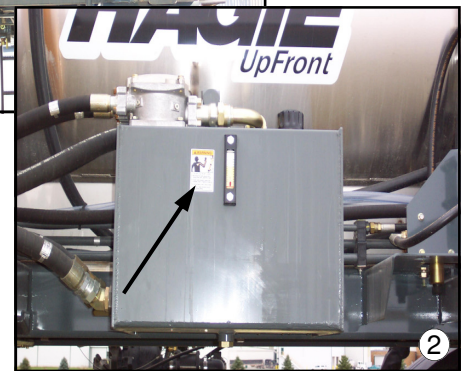

650379

Right side window, rear corner.



I. SAFETY/ DECALS



650819

2 on each cutter head housing.



650820

Quad puller head.

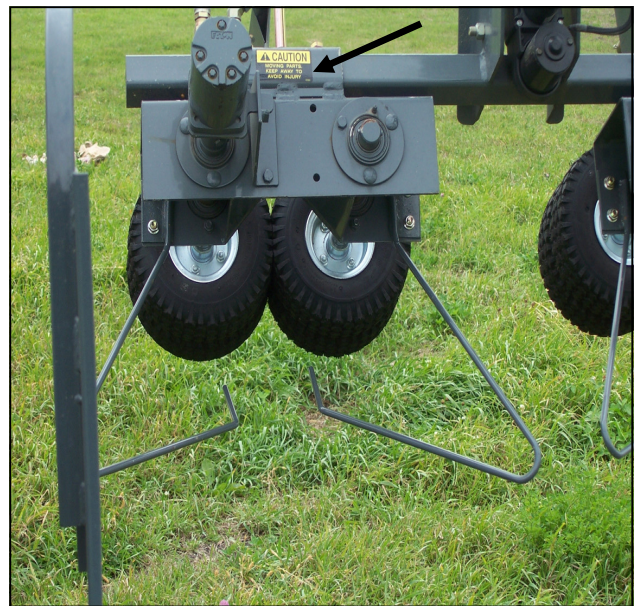

650848

On ladder pivot tube.

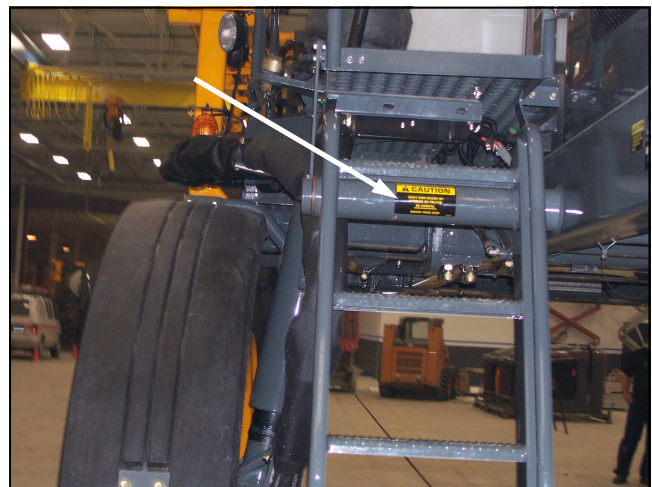

I. SAFETY/ DECALS



On engine compartment, near fuel cell cap.

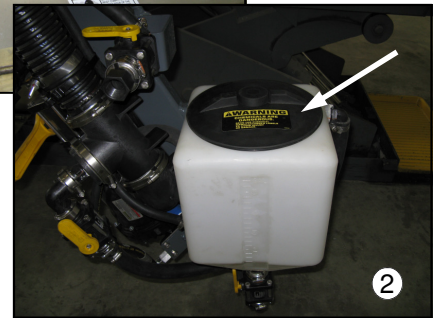
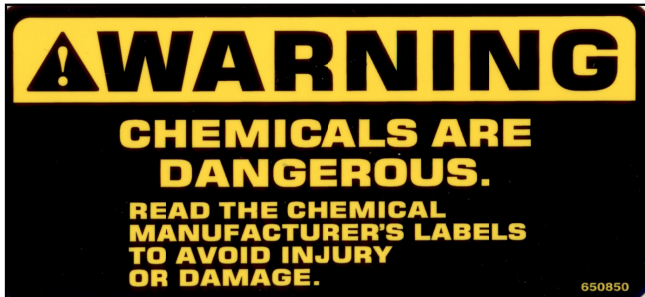

650850

On solution tank, near fill lid. (1) (front fill)

On inductor tank lid. (2) (side fill)

I. SAFETY/ DECALS



Left rear mainframe.

650851



650981

In engine compartment, near radiator cap.

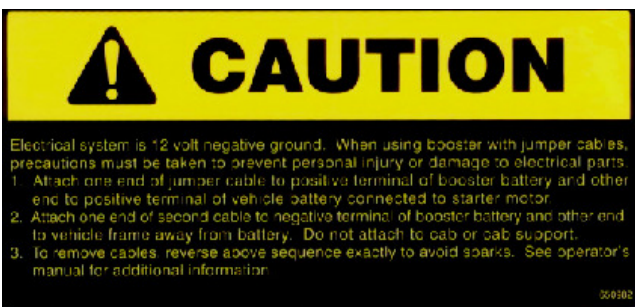

650982

On fuel cell near batteries.



Fuel cell

II. IDENTIFICATION NUMBERS

Each Hagie sprayer is identified by means of a frame serial number. This serial number denotes the model, year in which it was built, and the number of the sprayer. For further identification, the engine has a serial number, the hydrostatic pumps have serial numbers, the wheel motors have identification tags, and the planetary hubs have identifica-

tion plates that describe the type of mount and gear ratio. To ensure prompt, efficient service when ordering parts or requesting service repairs from Hagie Manufacturing Company, record the serial numbers and identification numbers in the spaces provided below.

NOTE:

Reference to left-hand and right-hand used throughout this manual refers to the position when seated in the operator's seat facing forward.

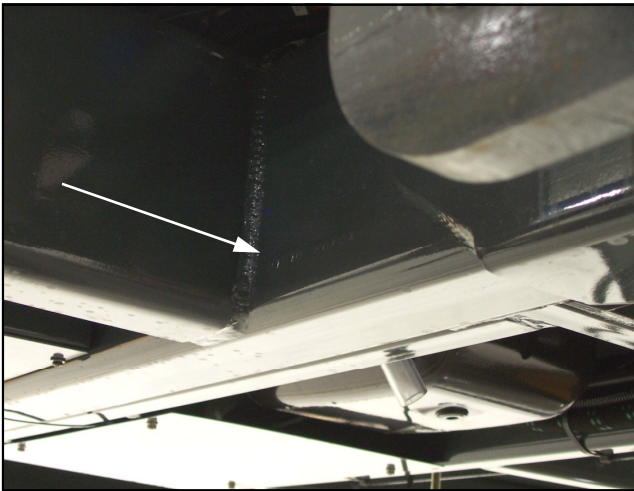

Sprayer

NOTE: Sprayer serial number stamped in the frame on right rear corner.

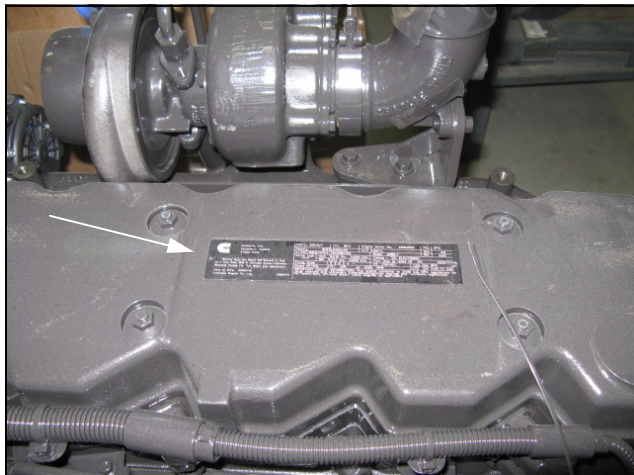

Engine

NOTE: Diesel engine serial number located on the valve cover.

II. IDENTIFICATION NUMBERS

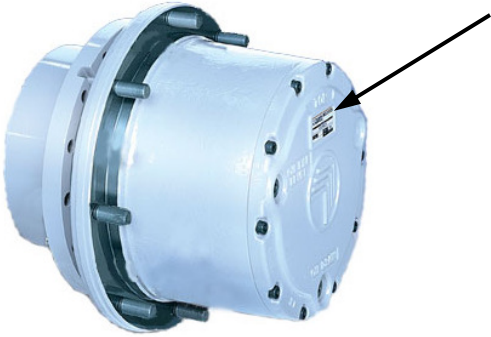

Wheel Hubs

	Left	Right
Front:	_____	_____
Rear:	_____	_____

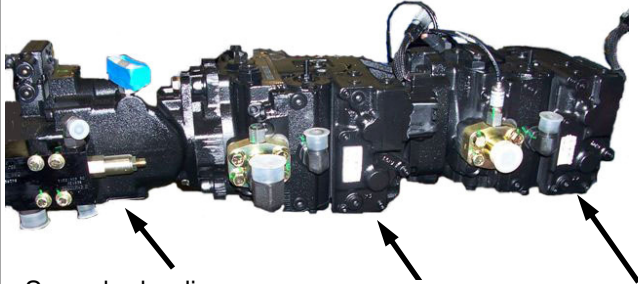

Sauer hydraulic pump Rear Front

Hydrostatic Pumps

Front: _____

Rear: _____



Front Wheel Motors

Left: _____

Right: _____

Refer to parts manual.



Rear Wheel Motors

Left - w/
Sensor: _____

Right - w/
Sensor: _____

Refer to parts manual.

III. SPECIFICATIONS

A. ENGINE

Manufacturer and model	Cummins
Model.....	QSB6.7-275
Type	Electronic with air to air cooler and turbocharger
Number of cylinders	6
Displacement	6.7 liter (360 c.i.)
Power	275 hp (205 kW), intermittent
Type of fuel.....	Number 1 or number 2 diesel
Fuel system	Filtered, direct-injected
Air cleaner	Dry-type, single element
Engine air filter restriction monitor	Filter Minder®
Slow idle	800 RPM
Fast idle.....	2500 RPM (no load)

B. POWER TRAIN

1. Drive

Hydrostatic pump	Sauer-Danfoss (Tandem 90 series)
Displacement.....	150cc (75 X 2) with electronic displacement control
Drive train	All-time four wheel drive
Speed ranges	3 work mode 4 transport mode
Hydrostatic wheel motors- front and rear	Sauer-Danfoss (90 series)
Final drives	
Type	Planetary gear reduction hubs
- front	Bonfiglioli hub (26:1)
- rear.....	Bonfiglioli hub (30:1)
Lubrication.....	Oil bath

2. Brakes (parking only)

Type	Multiple disc Spring applied Hydraulically released
------------	---

3. Steering System

Type	Hydraulic, dedicated circuit
Control.....	Full-time power
Steering cylinders.....	Self-centering, double action

III. SPECIFICATIONS

C. ELECTRICAL SYSTEM

1.General Electrical System

Battery	Dual 12V, negative ground
Alternator	160 AMP, voltage regulated
Starter	12V with solenoid

2.Circuit Breakers/Fuses

FUSE MODULE 1

MDM Module	3 AMP (1 each)
Input power, control handle,	5 AMP (4 each)
console switch, console lights, field and work lights	
Ignition, hazard lights, head	10 AMP (4 each)
lights switch, seat air ride, XS- A0 and A1 module power	
Terminal strip power, HVAC control	15 AMP (7 each)
power, power point 1, wiper/washer, power point 2, XS-A2 module power, Norac (if equipped)	
Raven console, XT2- A1 module	20 AMP (2 each)
power	
HVAC fan- high.....	25 AMP (1 each)

FUSE MODULE 2

Ignition ON.....	5 AMP (1 each)
Radio, dome light, MDM RTC,	10 AMP (4 each)
diagnostic plug, (spare)	
Head lights-2 , terminal strip power,	15 AMP (6 each)
agitator/ rinse valves, air dryer, side fill, pressure washer (if equipped), field lights	
XP2-A0 module power, XT2-A0	20 AMP (6 each)
module power, XP2-A1, A2 and A3 module power, boom valves	

RELAY MODULE 1

Head lights-2, reverse, forward,	12V micro relays
field lights-1 and 2, console light	

III. SPECIFICATIONS

RELAY MODULE 2

Brake light, spare (3), ignition ON, 12V micro relays
HVAC high fan

ENGINE ELECTRICAL BOX

Fuses 7.5 AMP (3 each)
10 AMP (2 each)
20 AMP (1 each)
125 AMP (2 each)

Relays

Start 12V/ 40AMP (1 each)
Intake heater 1 and 2..... 12V micro (2 each)

Circuit Breaker

Main breaker..... 100 AMP (1 each)

OTHER FUSES AND RELAYS

Flasher/ light harness 12V flasher relay
15 AMP fuse (4 each)
40 AMP relay (3 each)
Main rear harness30 AMP fuse
Main chassis5V relay
Console Relay..... 15V/ 100 AMP

COMBO UNIT ELECTRICAL BOX

Circuit Breaker20 AMP (1 each)
Relay..... 12V micro relay

3.Lights

Front of cab..... 2 Trapezoidal head lights, 4 flood lights
Transom mount..... 2 Trapezoidal head lights
Boom cradle (forward) 2 Trapezoidal flood lights (1 each)
Boom cradle (rearward) 2 Trapezoidal flood lights (1 each)
2 Oval amber lights (1 each)
Rear engine hood 2 Round red lights
2 Round amber lights

III. SPECIFICATIONS

Transom (boom indicator)	1 Oval white LED
	2 Oval amber LED
	5 Oval red LED

D. CAB AND INSTRUMENTS

1. Cab

General cab	Tilt steering Windshield wiper/washer Dual side mirrors Dome light Tinted glass Training seat
Temperature control	Full-range
A/C charge type	R-134a
Fresh air filtration	Paper and charcoal filter
Seat	Air ride

2. Instruments

Message center	Hour meter Fuel Water temperature Battery voltage Engine oil pressure Ground speed Engine RPM Tread adjustment assist
Stereo	AM/FM/WB with CD

E. CAPACITIES

Solution tank	1400 gallons (5299.58 ℓ)
Fuel cell	150 gallons (530 ℓ)
Cooling system (including block, lines, & radiator)	18 gallons (68 ℓ)
Hydraulic oil (including tank, lines, filter, & cooler)	55 gallons (208 ℓ)
Rinse system tank	100 gallons (379 ℓ)
Foam marker tank	36 gallons (136 ℓ)
Engine oil (including crankcase, lines, filter, & cooler)	18.5 quarts (17.5 ℓ)
Wheel hubs	
Front (2)	40 oz. (1.8ℓ) each (approx.)
Rear (2)	40oz. (1.8ℓ) each (approx.)

III. SPECIFICATIONS

F. AUXILIARY HYDRAULIC SYSTEM

TypeSingle closed center pump, single gear pump
(used to cool and supplement the combo unit)
Pump type.....Load sense

G. SPRAY SYSTEM

1. Booms

TypeDry, with variable row spacing(optional wet)
Standard.....60/80/90/100 ft. (5 spray sections)
Controls.....Electro-hydraulic: fold/lift/level
Level shock absorber.....Gas-charged accumulator
Outer boom tip hydraulic breakaway.....Self-actuated, auto-reset hydraulic

2.Solution Fill Connection

Quick-fill connection3 in. (7.6 cm) I.D.

3.Solution Tank

Standard.....1400 gal. (5299.58 ℓ) stainless steel w/sight
gauge
Agitation (stainless steel tank)Sparge-type w/elect. var. speed control

4.General Spray System

Pump.....Centrifugal - hydraulically driven with
pulse width modulated control valve
Solution valvesElectric ball valves
Pressure gauge.....100 PSI glycerin filled
ConsoleRaven 4600 (GPS-ready)
Fence row nozzleTwo position, remote activated

H. FOAM MARKING SYSTEM

MakeHagie Foam Marker
TypeLive air

I. RINSE SYSTEM

Spray system rinse (solution tanks, pump, and booms) Standard
High pressure washing system Optional

III. SPECIFICATIONS

J. DETASSELING EQUIPMENT OPTIONS

1. General Detasseling System

Monitor/controls	Tasselrol 6L control box
General system.....	Light Sensing System Depth command, Electrical quick disconnect, Hydraulic couplers

2. Outriggers

12 Row	134" (1 Left, 1Right)
8 Row.....	75" (1 Left, 1 Right)

3. Quad Puller

Number of rows available	8,10, or 12
Drive.....	Hydraulic
Tire size	4.10/3.50 2 ply
Operating speed	Up to 400 RPM

4. Cutter

Number of rows available	8,10, or 12
Drive.....	Hydraulic
Blade size	18"
Operating speed	Up to 3100 RPM

III. SPECIFICATIONS

K. TIRES (front and rear)

Standard.....	380/85R46 (Radial TU)
Air pressure	35 PSI (240kpa)
Tire width	15.0 in. (381 mm)
Loaded capacity @ 25 MPH (40.2 Km/H)	7150 lbs. (3250 kg)
Overall diameter	72.7 in. (1847 mm)
Static load radius (suggested– will vary with load).....	33.5 in. (851 mm)
Rolling circumference	219.0 in. (5563 mm)
Optional (narrow row crop)	380/90R54 (Radial TU)
	320/90R50 (Radial TU)
	320/105R54 (Radial TU)
Air pressure	35 PSI (517kpa)
Tire width	12.6 in. (381 mm)
Load capacity @ 30 MPH (40.2 Km/H)	6800 lbs (5987.5 kg)
Overall diameter	72.6 in. (2042.2 mm)
Static load radius (suggested– will vary with load).....	33.8 in. (947.42 mm)
Rolling circumference	219.0 in. (6147 mm)
Optional (wide)	580/70R38 (Radial TU)
Air pressure	23 PSI (160kpa)
Tire width	23.1 in. (587 mm)
Load capacity @25 MPH (40.2 Km/H)	8550 lbs. (3875 kg)
Overall diameter	72.2 in. (1834 mm)
Static load radius (suggested– will vary with load).....	32.04 in. (823 mm)
Rolling circumference	216.4 in. (5497 mm)
Optional (floatation)	520/85R46 (Radial TU)
Air pressure	23 PSI (160 kpa)
Tire width	21.3 in. (541 mm)
Load capacity @25 MPH (40.2Km/H)	9350 lbs. (4241 kg)
Overall diameter	80.6 in.(2047 mm)
Static load radius (suggested– will vary with load).....	36.3 in. (922 mm)
Rolling circumference	242.1 in. (6150 mm)

IV. OPERATING SYSTEMS

A. CAB

Front Console

- | | |
|---|----------------------------------|
| A. Hazard/ Warning light switch | F. Ignition switch |
| B. Highway lights, running light switch | G. Steering wheel tilt adjust |
| C. Steering Wheel | H. Steering column release pedal |
| D. Turn signal indicator light | |
| E. Turn signal switch | |

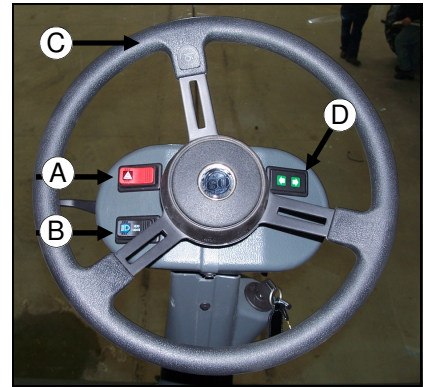

FIG. 21-1

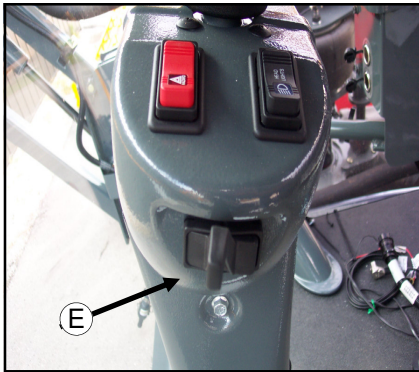

FIG. 21-2

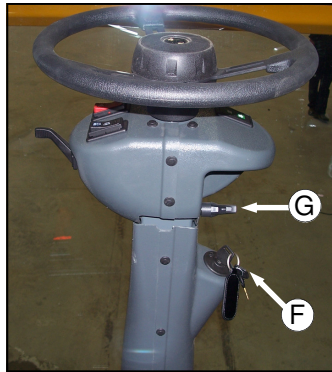

FIG. 21-4



FIG. 21-3



FIG 21-5

HAZARD/ WARNING LIGHTS—To activate the flashing hazard/ warning lights (fig. 21-5 and fig. 21-6) depress the “FLASHER” switch (fig. 21-1, item A). Activate the hazard/ warning lights anytime, day or night, that you are traveling on a public road unless prohibited by law.

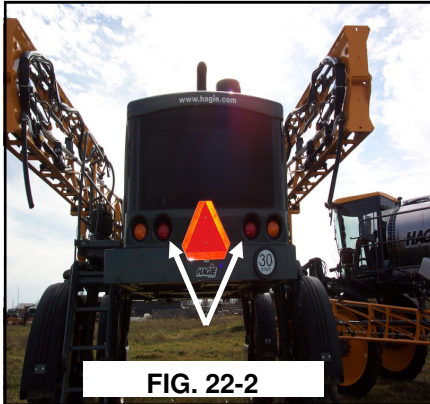

FIG. 21-6

IV. OPERATING SYSTEMS

A. CAB

HIGHWAY LIGHTS/RUNNING LIGHTS– The highway lights are mounted on the cab and the either side of the transom (fig. 22-1). Use these trapezoid head lamps when



traveling on a public road at night. Turn them on using the highway/running light switch located on the front console (fig. 22-1, item B).



Activating the highway lights will also turn on the “red” running lights on the rear of the machine (fig. 22-2).

The ignition key does not have to be on to operate these lights.



TURN SIGNALS– To activate the front turn signals (fig. 22-3) and the rear turn signals (fig. 22-4 and 5), move the turn signal lever (fig. 21-2, item E) forward, away from the operator, to signal a right turn and back, toward the operator, to signal a left turn. Steering column– mounted turn signal indicators will correspondingly flash when either turn signal is activated. The turn signal switch is not a self– centering switch; you must return it to the “OFF” position by

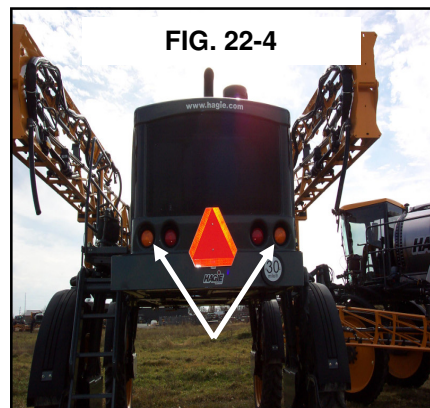

hand after completing your turn.



IV. OPERATING SYSTEMS

A. CAB

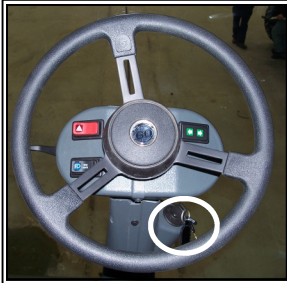

FIG. 23-1

IGNITION SWITCH– The ignition switch has three positions. The first position is the “OFF” position. The second position is referred to throughout this manual as “ON”, the second position is “START”. To engage the starter, turn the key to the “START” position and hold momentarily until the engine engages. If the engine does not engage after 15 seconds, turn the key to “OFF”. Constant cranking of the starter when an engine fails to engage will cause damage to the battery and the starting system. Refer to OPERATING SYSTEMS section B on hydrostatic drive for more information.

TILT ADJUST HANDLE- The steering wheel tilt adjust handle is for the movement of the upper portion of the steering column only. The steering wheel has infinite position possibilities.

To use the adjustment handle turn it down (toward the operator) to loosen it. You do not need to remove the handle all the way, simply loosen it enough to freely move the steering wheel.

With the handle loosened, push or pull on the steering wheel until it is in a comfortable position. Hold the steering wheel in that position while tightening the adjustment handle. To tighten the adjustment handle turn it upward (away from the operator).



FIG. 23-2

NOTE:

Be sure the steering wheel and column are locked in place before trying to move the machine. Failure to do so will make it difficult to maintain control of the machine.

STEERING COLUMN RELEASE PEDAL– The steering column release pedal is for easy exit/ easy entry of the cab. Push the pedal to release the locking gas spring. With the gas spring released, you can smoothly move the entire steering column forward or backward.

To lock the column in place, simply remove your foot from the pedal while holding the column in place. Once the gas spring has locked again, check the column by firmly trying to move the column in either direction.

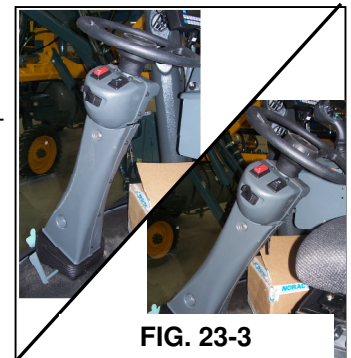

FIG. 23-3

IV. OPERATING SYSTEMS

A. CAB

Side Console

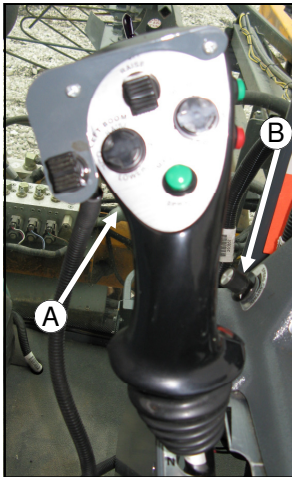

FIG. 24-1

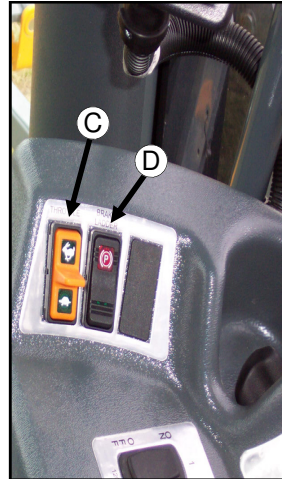

FIG. 24-2

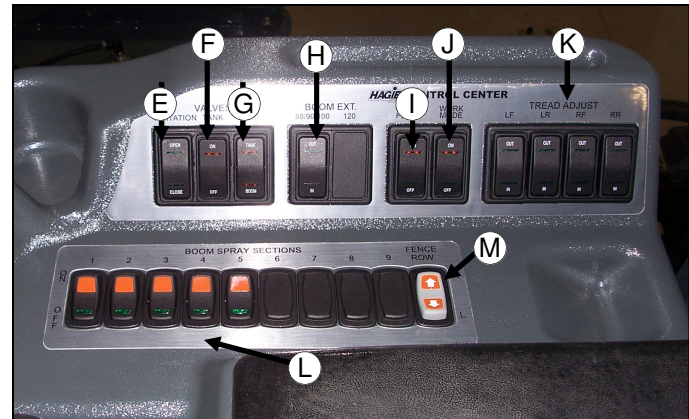

FIG. 24-3

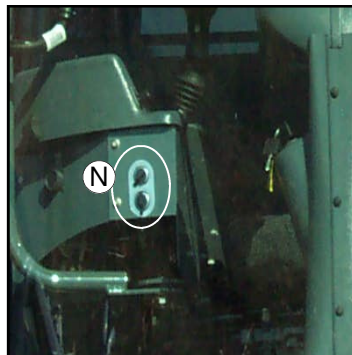

FIG. 24-4

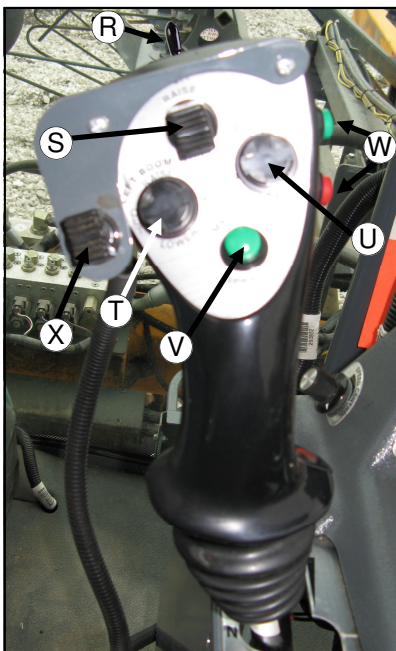

FIG. 24-6

- A. Hydrostatic Lever
- B. Speed Control
- C. Throttle switch
- D. Brake/Ladder switch
- E. Agitation switch
- F. Solution Tank switch
- G. Rinse Tank switch
- H. Boom Extension switch
- I. Float switch
- J. Work Mode switch
- K. Tread Adjust switches
- L. Boom Spray Section switches
- M. Fence Row Nozzle switch
- N. Power Ports

- O. Forward
- P. Neutral/Stop
- Q. Reverse
- R. Foamer switch
- S. Hydraulic Lift
- T. Left Boom (level, horizontal fold)
- U. Right Boom (level, horizontal fold)
- V. Master switch "ON"
- W. Speed Range switch
- X. All Up/Hold switch

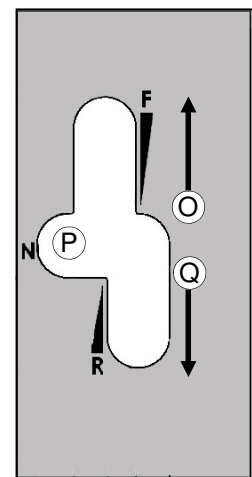

FIG. 24-5

IV. OPERATING SYSTEMS



FIG. 25-1

HYDROSTATIC LEVER– The hydrostatic lever is used to control the direction of motion of the machine and the speed at which it travels. It is a part of the ACE hydrostatic drive system or the Automatically Controlled Engine Hydrostatic Drive. To learn more about the ACE system, refer to the OPERATING SYSTEMS section B on the hydrostatic drive system.

The lever also houses controls for the spray systems and foam marking systems. For information on these controls, refer to OPERATING SYSTEMS section D on the spray system.

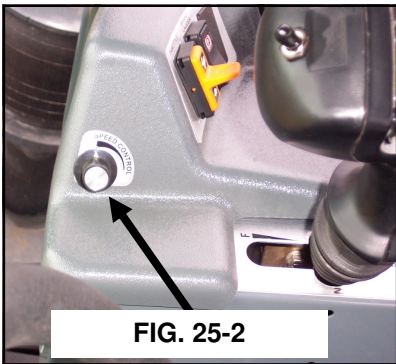

FIG. 25-2

SPEED CONTROL- Another feature of the hydrostatic drive system is the speed control. This feature will help regain consistent field speeds when re-entering a field from the end rows.

The speed control will maintain its setting until you reset it. It does not have to be reset each time you turn off the machine.

For information on how to use the speed control feature, refer to OPERATING SYSTEMS section B on the hydrostatic drive system.

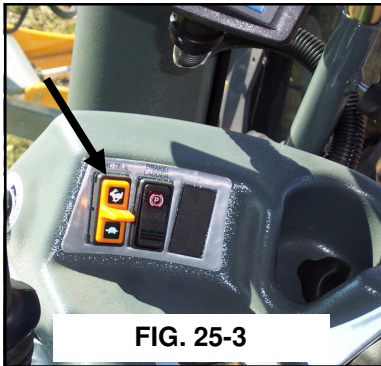

FIG. 25-3

THROTTLE SWITCH- The throttle switch (fig. 25-3) is used to control engine RPM. There are 2 settings that are controlled by the switch, high and low, with a RPM range of 800 to 2500.

The buttons on the side of the hydrostatic lever (fig. 25-4) are to control the speed ranges within the RPM setting. For more information on the throttle



FIG. 25-4

controls, refer to OPERATING SYSTEMS section B on the hydrostatic drive system.



FIG. 25-5

PARKING BRAKE- The parking brake switch is located next to the throttle switch on the side console. The switch also controls the ladder. The brake switch must be on to lower the ladder and to run the side fill or pressure washer (if equipped).

The parking brake is not intended for normal or emergency stopping and will not engage if the machine is moving over 1 mile per hour. Activating the brake while the machine is still moving is hazardous to the operator and the sprayer. Bring the sprayer to a complete stop with the hydrostatic lever in the neutral position before applying the parking brake.

IV. OPERATING SYSTEMS

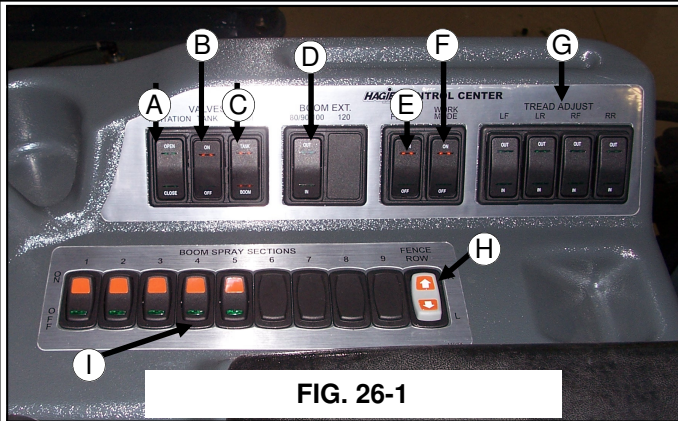

FIG. 26-1

AGITATION SWITCH- The agitation switch (fig. 26-1, item A) controls the rate of flow through the sparge system. For more information on the agitation system, refer to OPERATING SYSTEMS section D on the Spray Systems.

TANK SWITCH- The tank switch (fig. 26-1, item B) controls the solution tank valve. This switch must be on to spray. For more information on the

tank switch, refer to OPERATING SYSTEMS section D on the spray system.

RINSE SWITCH- The rinse switch (fig. 26-1, item C) is used when you wish to rinse the solution tank or the booms. For more information on how to use the rinse system, refer to OPERATING SYSTEMS section F on the rinse system.

BOOM EXTENSION SWITCH- Boom extension (fig. 26-1, item D) switches are used when folding and unfolding the booms. Refer to OPERATING SYSTEMS section C on spray booms.

FLOAT SWITCH- The float switch is used with the Nitrogen Tool Bar and is not covered in this manual.

WORK MODE SWITCH- The work mode switch (fig. 26-1, item F) is a safety switch. There are systems controlled by this switch that will not function if the switch is not ON. The switch can not be turned on if certain conditions exist. You can not turn the switch on if the machine is not in neutral. The switch controls the functions of the spray system and detasseling system. This was set up to protect you, the operator, and others from accidentally engaging certain systems while transporting. Be sure that this switch is on before you intend to engage the spray or detasseling system.

TREAD ADJUST SWITCH- The tread adjust switches (fig. 26-1, item G) are used to hydraulically adjust the tread width. These switches will not do anything if you do not have hydraulic tread adjust. For more information on hydraulic tread adjustment, refer to OPERATING SYSTEMS section C on the hydraulic system.

FENCE ROW SWITCH- The fence row switch (fig. 26-1, item H) is for the selection of right or left fence row spray nozzle. More information on the fence row can be found in OPERATING SYSTEMS section D on the spray system.

BOOM SOLUTION VALVE SWITCH- The boom solution valve switches (fig. 26-1, item I) each control a valve located on the transom and the booms. The valves control the flow of solution through the boom. The boom is broken down into 5 sections (3 sections on a 60' boom), the far left tip being the beginning of section one. See section E under OPERATING SYSTEMS on the spray system for more information.

IV. OPERATING SYSTEMS

A. CAB



POWER PORTS- On the front of the side console there are two power ports (fig. 27-1) for extra equipment to be plugged in. They are each protected by a 15 amp fuse. They are not intended for the permanent connection of extra systems to the sprayer. There is a terminal strip intended for the installation of extra radios and computer equipment. See the SERVICE section E on the electrical components.

FOAMER SWITCH- The foamer switch on the top of the hydrostatic lever (fig. 27.2, item A) controls the foam option on either side of the machine. See OPERATING SYSTEM section E for more information on the foamer. This switch does not operate anything in the detasseling mode.

MAIN CONTROL SWITCH- The main control (fig. 27-2, item E) in the lower middle of the hydrostatic lever is so the operator can turn all selected spray valves or detasseling heads on/off at one time. See OPERATING SYSTEMS section E and F for more information.

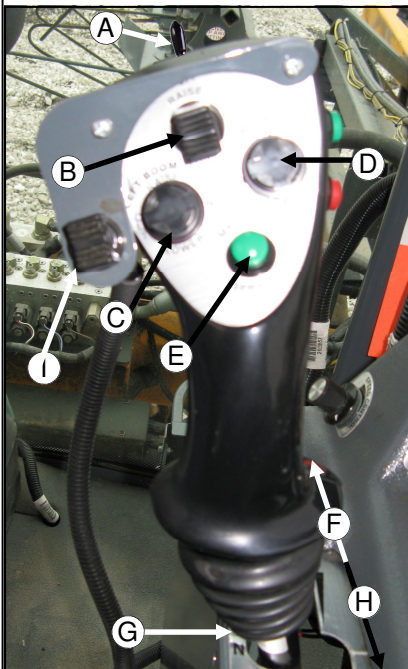

FIG. 27-2

FORWARD CONTROL- The hydrostatic lever is responsible for the direction of motion of the machine. To move forward, slowly move the hydrostatic lever forward. (fig. 27-2, item F)

REVERSE CONTROL- To move the machine in reverse, slowly move the hydrostatic lever backward. (fig. 27-2, item H) Be sure that the machine is clear of all dangers before putting it in reverse.

NEUTRAL POSITION- The neutral position is also the stop or brake position. (fig. 27-2, item G) The neutral position must be met before changing direction of the machine. There are several functions that can not be performed if the machine is not in the neutral position.

More information on the forward, reverse, and neutral positions of the hydrostatic lever is available in section B of the OPERATING SYSTEMS.

LIFT, LEVEL, HORIZONTAL FOLD- (fig. 27-2, items B, C, and D) are all a part of the hydraulic system. A complete explanation of their functions can be found in section C of the OPERATING SYSTEMS.

ALL UP/HOLD- The all up/hold switch (fig. 27-2, item I) is used to control all of the lifts on the detasseling/combo bar. Instructions for programming the switch are found in Tasselrol® section of SYSTEM PROGRAMMING.

IV. OPERATING SYSTEMS

A. CAB

Overhead Controls and Monitors

- A. Hagie Diagnostic Port
- B. Warning Indicator Light
- C. Spray System Indicator Light
- D. MDM
- E. Wiper switch
- F. Washer Fluid switch
- G. Field Lights switch
- H. Work Lights switch
- I. Climate Control– fan
- J. Climate Control– temp
- K. Raven Console
- L. Radio
- M. Vents
- N. Tasseltrol Control Box/ Detasselling Switch Panel

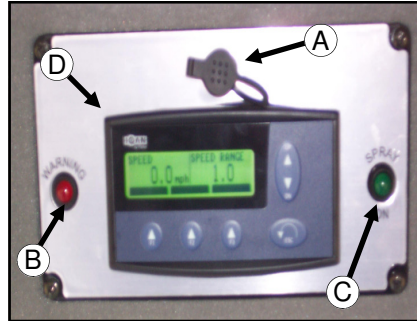

FIG. 28-1

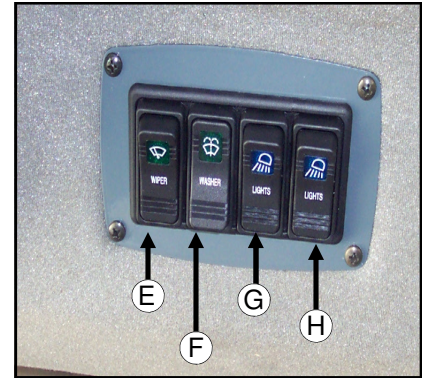

FIG. 28-2



FIG. 28-3



FIG. 28-4

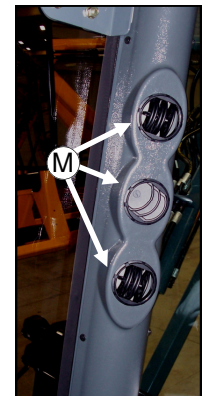

FIG. 28-6



FIG. 28-5

HAGIE DIAGNOSTIC PORT– The Hagie diagnostic port (fig. 28-1, item A) is used for diagnostic purposes only. The Hagie Customer Service department can hook into your system to gather information on faults and malfunctions of the machine. From this port, they would also be able to reprogram the machine if it becomes necessary. This port is not for the use of personal computers or personal digital assistants (PDA's).

The Hagie diagnostic port is protected by a 10 amp fuse.

WARNING INDICATOR LIGHT– The warning indicator light (fig. 28-1, item B) will come on if there are any malfunctions or faults in the systems monitored by the MDM. These warnings include, but are not limited to: engine oil pressure, oil level, hydraulic oil level, coolant temperature, battery voltage, and fuel level. An explanation of the fault will appear on the screen. If a fault appears, shut engine off immediately and resolve the fault before continuing. Failure to do so may result in damage to the system with the detected fault.

IV. OPERATING SYSTEMS

A. CAB

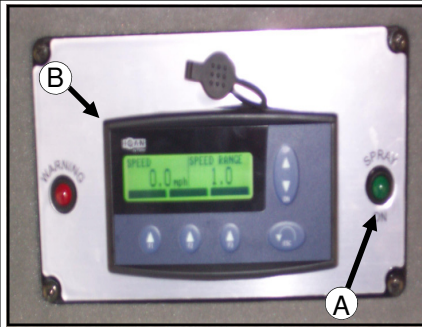

FIG. 29-1

SPRAY SYSTEM INDICATOR LIGHT– The spray system indicator light (fig. 29-1, item A) will illuminate when the work mode switch and the main spray control on the hydrostatic lever (fig. 29-2) has been activated. If the light is not on, the spray system is not on.



FIG. 29-2

MDM– The MDM (fig. 29-1, item B) is also referred to as the message center. The MDM takes the place of the conventional gauges. This monitor can give you information on tread adjust width, engine RPM, engine oil pressure, hour meter, fuel level, coolant temperature, tire size, battery voltage, speed range, and machine program version. The information can be viewed by using the up and down arrows to move through it. The MDM will also display any faults found in the monitored systems.

WINDSHIELD WIPER AND WASHER FLUID SWITCHES– The windshield wiper switch (fig. 29-3, item A) located on the right side of the headliner, turns on the wiper (fig. 29-5, item A). The wiper will continue to operate until the switch is returned to the OFF position. Replace the 39 inch blade as necessary.

To activate the washer fluid pump, press the washer fluid switch (fig. 29-3, item B) and hold until the desired amount of fluid is dispensed and then release the switch. You must turn the wiper OFF when the washer fluid has been completely wiped away. Washer fluid reservoir is located behind the cab (fig. 29-4).

The fluid nozzle (fig. 29-5, item B) is adjustable. Check spray pattern and adjust at the beginning of each spray season or as necessary.

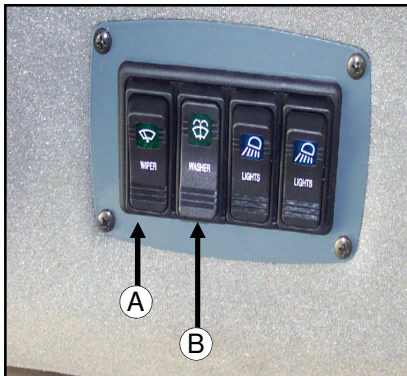

FIG. 29-3



FIG 29-4

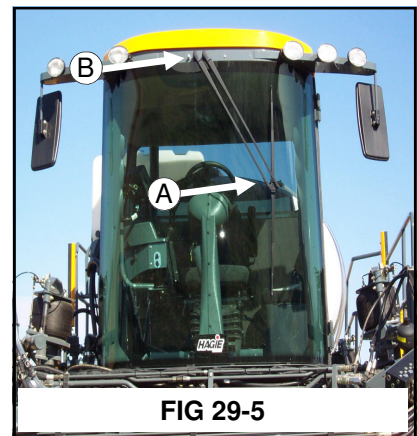

FIG 29-5

IV. OPERATING SYSTEMS

A. CAB

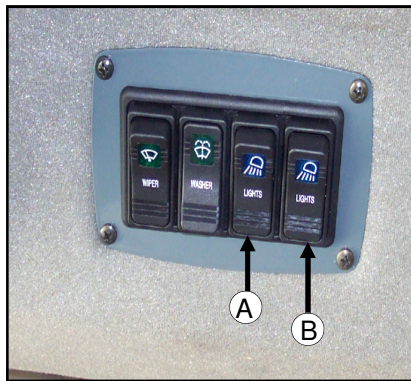

FIG. 30-1

FIELD LIGHTS AND WORK

LIGHTS— The field lights (fig. 30-2), located on the front of the cab with the headlights, are activated by pushing the switch located on the upper right cab headliner (fig. 30-1, item A). Use these lights when operating in the field after dark. Turn them off before entering a public roadway.



FIG. 30-2



FIG. 30-3

The work lights (fig. 30-3), located on each boom cradle, one facing forward and one facing backward, are activated by pressing the second switch (fig. 30.1, item B) located on the right upper cab headliner. These lights can also be used when operating in the field after dark. Turn them off before entering a public roadway.

The ignition key has to be on to operate these sets of lights, but extended use without the engine operating to charge the battery is not recommended.

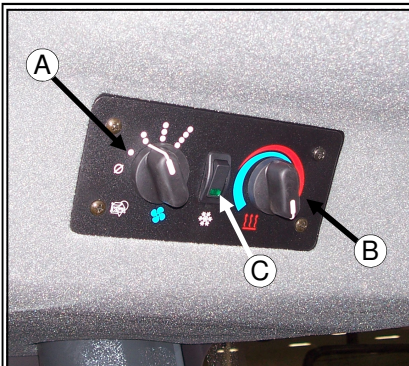

FIG. 30-4

CLIMATE CONTROLS - The climate controls (fig. 30-4) are continuous adjusting dial switches located on the front upper cab headliner.

Adjusting Fan Blower Speed— fan blower speed is controlled by the left rotary dial (fig. 30-4, item A). To increase the fan speed, rotate the dial clockwise. To reduce the fan speed, rotate the dial counterclockwise. To shut the fan off, rotate the dial all the way counterclockwise.

Adjusting Temperature Setting— forced air temperature adjustments are controlled by the right rotary dial (fig. 30-4, item B). Temperature control is a continuously variable adjustment. To increase the forced air temperature, rotate the dial clockwise. To decrease the forced air temperature, rotate the dial counterclockwise.

Operating the Air Conditioning— to activate the air conditioner, press the air conditioning switch (fig. 30-4, item C). Adjust fan speed and temperature accordingly. See section B under SERVICE for servicing information.

IV. OPERATING SYSTEMS

A. CAB



FIG. 31-1

VENTS– There are 6 adjustable vents, 3 on each front cab corner post (fig. 31-1). They may be adjusted by rotating them for desired direction, or individually turned on or off with the directional fins.

RADIO–The cab has AM/FM tuner equipped with a CD player and Weather Band broadcasting. Refer to the radio manufacturer’s manual for operating and programming information.



FIG. 31-2



FIG. 31-3

RAVEN SPRAY SYSTEMS CONSOLE– The spray system is controlled by the Raven SCS 4600 (fig. 31-3) and the Pulse Width Modulated Valve (fig. 31-4). The system receives data and automatically makes adjustments based on the target rate of application set by the operator.

For detailed information regarding the programming and operating of the Raven console

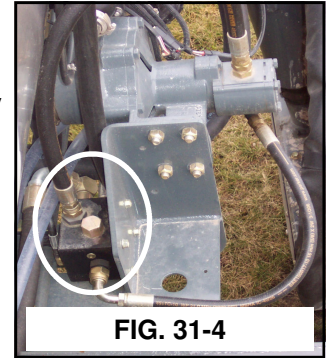

FIG. 31-4

system, please refer to the manufacturer’s installation and operation manual.

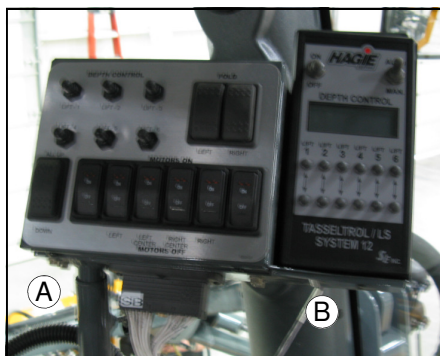

FIG. 31-5

TASSELROL CONTROL BOX/ DETASSELING SWITCH

PANEL–The detasseling heads and lift assemblies are controlled by the Hagie Tasselrol®/LS System 12 (fig. 31-5, item B) and the controls on the detasseler switch box assembly (fig. 31-5, item A). Refer to section B under SYSTEM PROGRAMMING for details on the Hagie Tasselrol® box. Continue reading this section for detailed information on the functions of the switches.

These controls are changed out with the Raven console when the detasseling option is being used. Refer to section D under OPERATING SYSTEMS for detailed information on switching the control panels.

When either of the panels are not in use, store them in a safe and dry place. Excessive moisture may cause corrosion of the electrical components. Before plugging a control panel into the machine’s electrical system, check the panel for damage such as a loose or cut wire or corrosion. If damage exists, do not connect the panel as it may cause a short in the system and could potentially cause a fire.

IV. OPERATING SYSTEMS

A. CAB

Other Features

- A. Res-Q-Me Tool/ Emergency Exit
- B. Cab Glass
- C. Rear-viewing Mirrors
- D. Buddy Seat
- E. Cab Fresh Air Filters
- F. Interior Lights
- G. Air-Ride Seat



FIG. 32-1



FIG. 32-2



FIG. 32-3



FIG. 32-4



FIG. 32-4

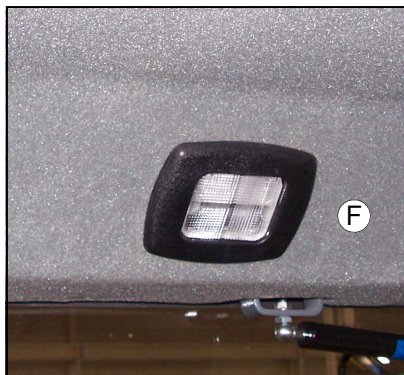

FIG. 32-6



FIG. 32-7

INTERIOR LIGHTS— The cab has two interior lights. A dome light that comes on when the door of the cab is opened, and a courtesy light that comes on when the field lights are turned on. (fig. 32-6) The courtesy light illuminates the side console. The dome light can be turned on manually.

IV. OPERATING SYSTEMS

A. CAB



FIG. 33-1

RES-Q-ME TOOL/ EMERGENCY EXIT– The RES-Q-ME tool (fig. 33-1) located on the right rear cab frame, is used for an emergency exit. The device, when firmly pressed against any glass in the cab, will automatically trigger shattering the glass. Do not look directly at the glass as you use the tool.



FIG. 33-2

CAB GLASS– The glass of the cab is DOT approved tempered glass. The front windshield is rounded with a green UV reflective tint and the side and back panels are flat with a UV reflective gray tint.

The design of the cab and the use of the glass allows a 210° view , tip to tip of the booms from the operator's seat.



FIG. 33-3

REAR VIEWING MIRRORS– The cab also has two external rear viewing mirrors (fig. 33-3).

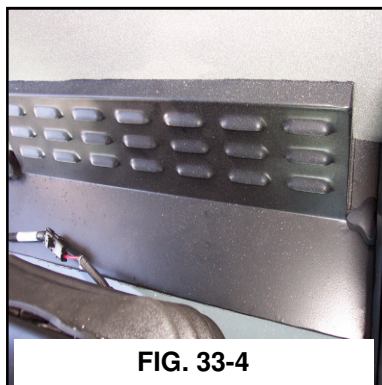

FIG. 33-4

CAB FILTERS– Inside the cab are two filters (fig. 33-4), a charcoal filter and a paper filter. Refer to the SERVICE section B on filters for maintenance information. Refer to the Hagie Parts Manual for replacement part information.

IV. OPERATING SYSTEMS



FIG. 34-1

BUDDY SEAT– The buddy seat (fig. 34-1) was designed as an instructional tool. It is specifically designed for a “co-pilot” to be seated in a good position to be taught how to use the sprayer.

The buddy seat has a hinged seat that lifts to reveal a storage compartment. Do not use the compartment to store chemical soaked clothing or gloves.

AIR RIDE SEAT

- A. **Seat Cushion Adjustment:** Rotate knob to desired cushion position
- B. **Height Adjustment:** Pull knob out to lower seat. Push knob in to raise seat.
- C. **Lateral Isolator:** Lift lever to engage lateral isolator. Push lever down for lock-out.
- D. **Ride Firmness Adjustment:** Rotate knob counterclockwise for firm ride; clockwise for soft ride; and in the middle for an average ride.
- E. **Fore-Aft Adjustment:** Pull lever out and move seat.
- F. **Fore-Aft Isolator:** Lift lever to engage fore-aft isolator. Push lever down for lock-out.
- G. **Backrest Adjustment:** Lift lever to stop and lean rearward or forward to adjust backrest position.
- H. **Armrest Tilt Adjustment:** Turn counterclockwise to lower tilt; clockwise to raise tilt.
- I. **Lumbar Adjustment:** Rotate knob clockwise to increase lumbar support; counterclockwise to decrease support.

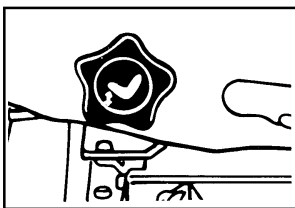

A

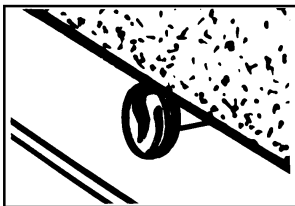

B

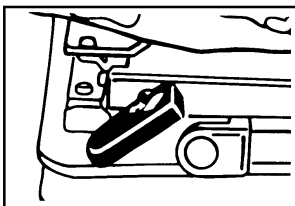

C

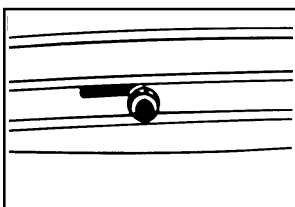

D

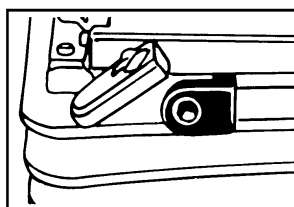

E

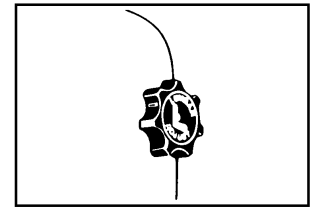

F

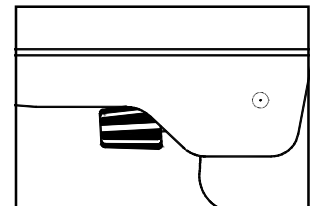

G

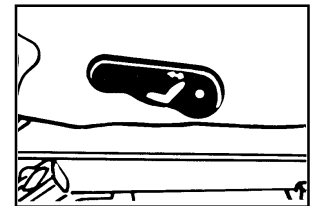

H

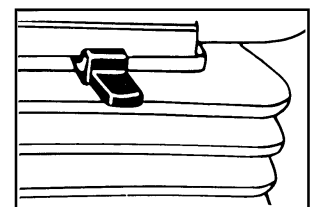

I

IV. OPERATING SYSTEMS

B. HYDROSTATIC DRIVE SYSTEM

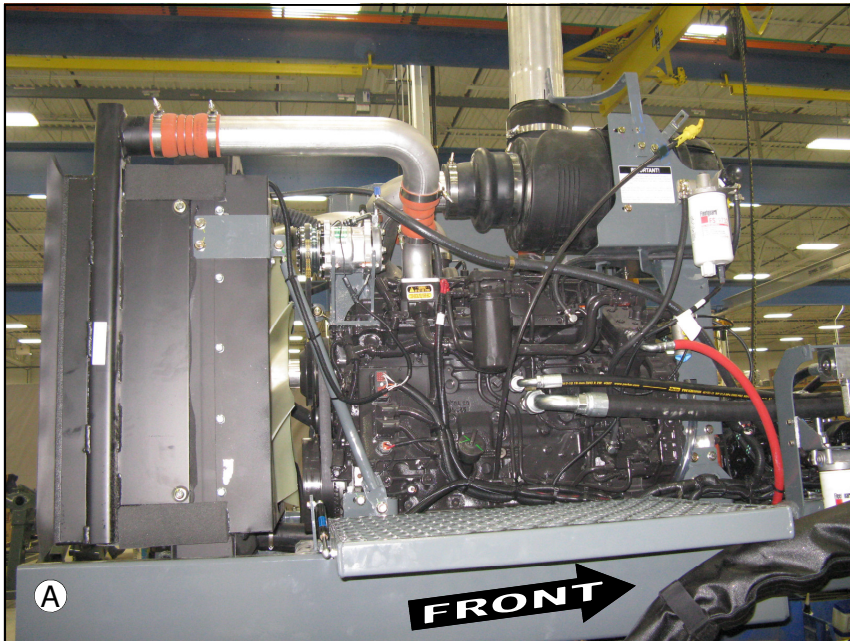

FIG. 35-1

- A. Cummins Engine
- B. Tandem Hydrostatic Pumps
- C. Front and Rear Wheel Motors
- D. Wheel Hubs

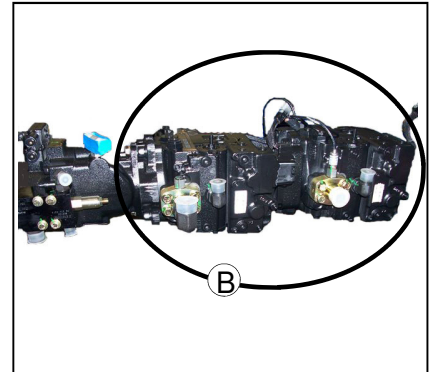

FIG. 35-2

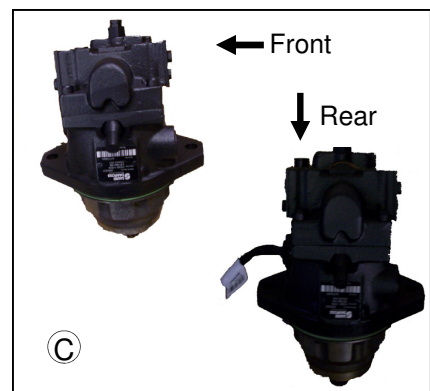

FIG. 35-3

CUMMINS ENGINE AND TANDEM PUMP– The STS 14 SPRAYER/DETASSELER comes standard with a 275hp Cummins diesel engine (fig. 35-1) equipped with an automatic exhaust brake. The engine has a direct mounted Sauer-Danfoss 90 Series tandem hydrostatic pump (fig. 35-2). More information on the operation of the engine is on the next page.

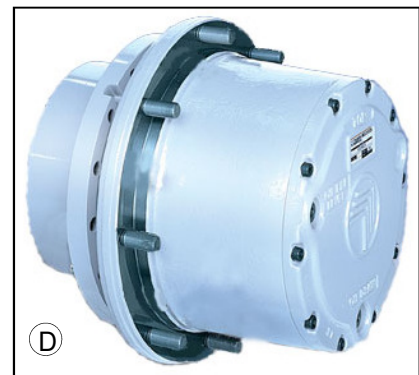

FIG. 35-4

WHEEL MOTORS AND WHEEL HUBS–The STS 14 SPRAYER/DETASSELER's all-time four wheel drive system consists of the Sauer-Danfoss hydrostatic wheel motors (fig. 35-3) and the planetary gear reduction hubs (wheel hubs) (fig. 35-4).

IV. OPERATING SYSTEMS

B. HYDROSTATIC DRIVE SYSTEM

Operating The Engine



CAUTION

Start engine from operator's seat only. When running engine in a building, be sure there is adequate ventilation.



Pre-operational Checks	Section Reference
1. Check the engine oil level. Do not operate when oil is below the low mark on the dipstick.	123
2. Check the coolant level in the radiator and the coolant overflow reservoir.	125
3. Check the hydraulic oil reservoir level.	123
4. Check the cooling air intake screen	128
5. Check the Filter Minder®.	127
6. Drain fuel/water separator.	129
7. Check engine drive belt.	135
8. Drain any water out of the air tank daily.	139
9. Check for any oil or fuel leaks and correct them if needed.	

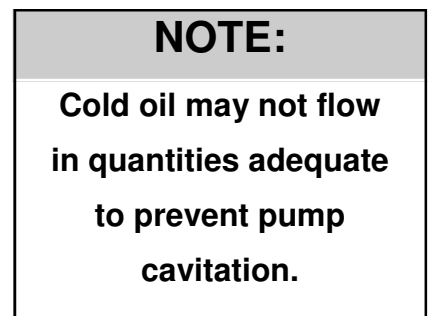
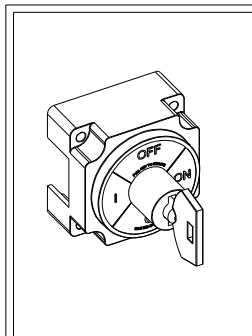

FIG. 36-1

BATTERY DISCONNECT- The STS SPRAYER/DETASSELER is set up with a battery disconnect safety device (fig. 36-1). This device is located on the left side of the rear frame cross tube. When the key is turned to the OFF position the electrical circuit is broken therefore rendering the machine unable to start. Do not use this device as a safety when working on the electrical system— disconnect the negative battery cable before servicing.

This device is also used as an anti-theft safeguard. Keep the key in a safe place, out of the machine when it is not in use.



IMPORTANT

Do not use disconnect to stop engine. Do not bypass disconnect. Do not terminate electrical devices to battery terminals. Disconnect negative before servicing electrical equipment. Completely isolate electronics before welding. Key must be inserted and rotated to "ON" position for operation.

660072

IV. OPERATING SYSTEMS

B. HYDROSTATIC DRIVE SYSTEM

STARTING THE ENGINE-

1. Position the hydrostatic lever to "N" (neutral) position (fig. 37-1).
2. Put the parking brake switch(fig. 37-2) to the ON position (see below). Turn the ignition key switch to the ON position, wait for the "wait to start" light in the message center (fig. 37-3) to go out before engaging the starter. If the engine fails to start after 15 seconds, turn the key to OFF, wait one minute and repeat the procedure. If the engine does not start in three attempts, check the fuel supply system. Absence of blue or white exhaust smoke during cranking indicates that no fuel is being delivered.
3. Observe the warning lights on the message center after start up. If any functions do not operate, shut off engine and determine the cause.
4. Always allow at least a five minute warm-up period before operating the engine at high RPM. This means that the engine must reach operating temperature and oil pressure must stabilize in the normal operating range before it is run faster than an idle (1000 RPM).

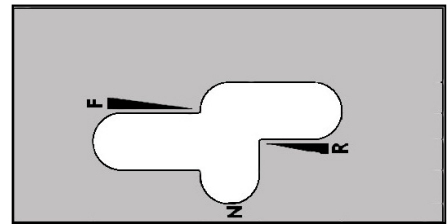

FIG. 37-1



FIG. 37-2



FIG. 37-3

PARKING BRAKE- The parking brake will engage if the charge pressure falls below 150 PSI or the engine is shut off. To engage the brakes manually, press the top of the PARKING BRAKE/LADDER switch (fig. 37-2) located on the side console.

To disengage the brakes, press the bottom of the switch. Always turn the brakes off before moving the sprayer.

The brake switch must be engaged to lower the ladder and to run the side-fill or pressure washer. The ladder will automatically lower when brake switch is pressed.

NOTE:

The parking brake will not engage over 1 mile per hour.



CAUTION

Activating the brake switch while the machine is moving is potentially hazardous to the operator and the sprayer.

IV. OPERATING SYSTEMS

B. HYDROSTATIC DRIVE SYSTEM

ACE: AUTOMATICALLY CONTROLLED ENGINE-

1. Speed ranges are selected by a red (decrease speed range) and green (increase speed range) electronic switch mounted on the hydrostatic lever (fig. 38-1, item A). The lower the setting, the higher the torque, but the lower the speed.
2. Increase the engine one bump to gain RPM of 1800 with the throttle switch (fig. 38-2). More RPM will be gained as you move the hydrostatic handle forward.
3. To move forward, slowly push the hydrostatic lever forward. The farther the hydrostatic lever is moved, the faster the sprayer will travel and the RPM 's will increase (fig. 38-3). To stop, slowly pull the lever to the "N" neutral position.
4. To reverse the machine, slowly pull the hydrostatic lever back. To stop, slowly push the lever to the "N" neutral position.
5. Before turning off the engine, reduce engine speed and allow the engine to idle at least three minutes.

NOTE:

Machine will not shift down until highest speed of desired range is met.

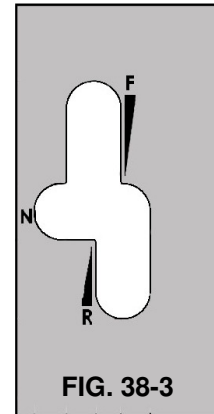
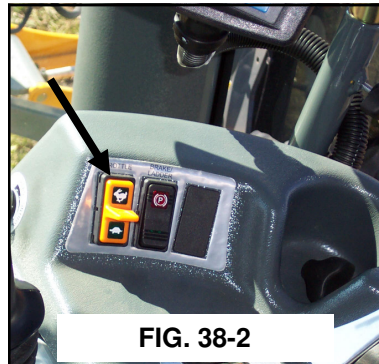
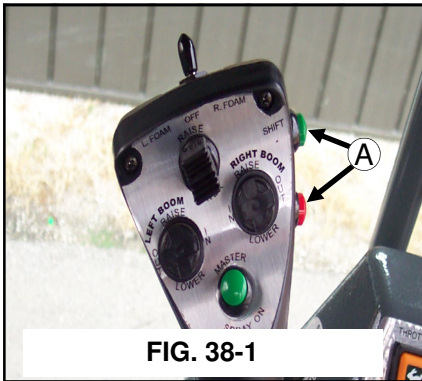

SPEED CONTROL— Speed control may be adjusted with the speed control dial (fig. 38-4) This will conveniently help regain consistent field speeds when re-entering a field from the end rows.

To set a speed limit, start with the engine at one bump on the throttle switch or 1800 RPM 's and speed control dial all the way counterclockwise. Push the hydrostatic lever all the way forward. Now turn the speed control clockwise while observing ground speed and stop turning the dial when the desired ground speed is reached. Now your maximum field speed is set and you simply reposition the lever all the way forward to regain that speed.

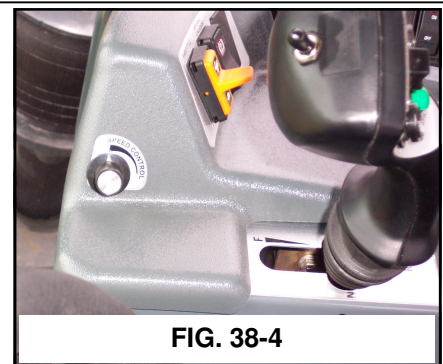

IV. OPERATING SYSTEMS

C. HYDRAULIC SYSTEM

BASIC MACHINE



- A. Hydraulic Pump
- B. Power Steering
- C. Ladder
- D. Tread Adjust
- E. Gear Pump

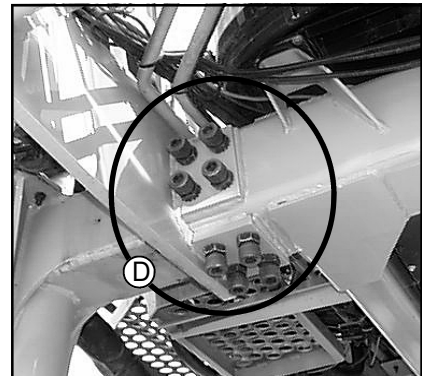
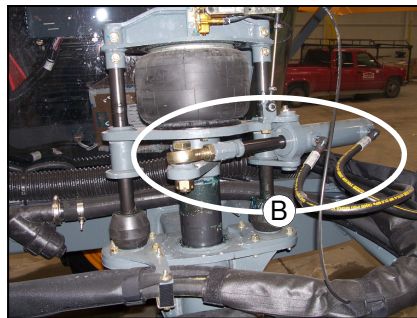
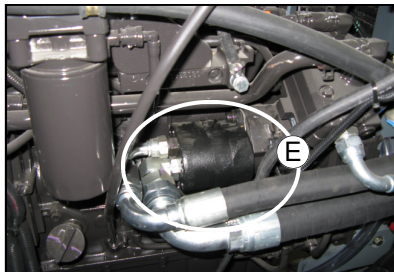
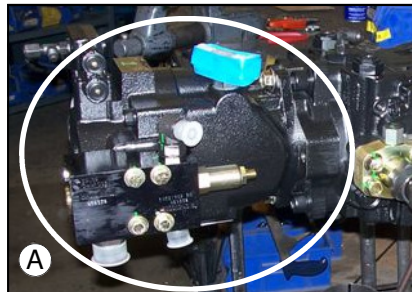

The **AUXILIARY HYDRAULIC SYSTEM** is a load sensing, pressure compensated system with efficiency in mind. That means it only pumps the amount of oil needed to do the job.

The pump is mounted to the “front” of the second hydrostatic pump (fig. 39-2).The systems consist of a single variable displacement pump that supplies the required hydraulics to operate the full time power steering unit, boom control cylinders (lift, level, and fold), tread adjust, ladder, outer boom breakaway, and the solution pump.

The return oil from the load sense pump is mixed with the oil from the gear pump (fig. 39-1) on the side of the engine. This pump supplies a constant flow of oil from the hydraulic tank to the cooler and then back to the tank through the filter. This is considered a kidney loop and is dedicated to the cooling and filtration of the hydraulic system.

For detasseling operation, there is an additional valve to include the gear pump flow into the system to supplement hydraulic flow for operation of three or more lift sections.

IV. OPERATING SYSTEMS

C. HYDRAULIC SYSTEM

BASIC MACHINE

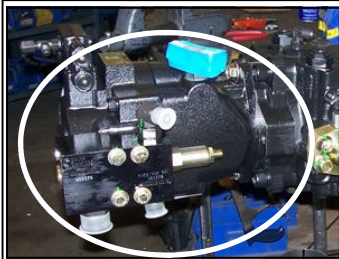

FIG. 40-1

HYDRAULIC PUMPS— The hydraulic pumps (fig. 40-1) circulate the hydraulic oil throughout the necessary systems and back through a cooler before returning it to the reservoir.



FIG. 40-2

During deteasseling operations, the gear pump (fig. 40-2) and relief manifold (fig. 40-3) are used to

supplement the hydraulic pump in maintaining the correct operating pressure while still allowing the oil to move through the filtration and cooling systems.

If the level in the reservoir drops too low to safely operate the machine you must shut down the engine immediately to prevent damage to the hydraulic system.



FIG. 40-3

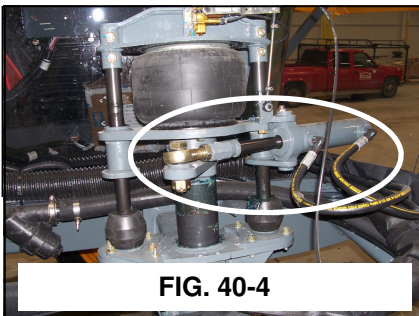

FIG. 40-4

POWER STEERING SYSTEM— The power steering is a dedicated circuit steering system with full time control and self centering/ double action steering cylinders.



LADDER- To raise or lower the ladder you will need to locate the BRAKE/LADDER switch at the front of the right hand console (fig. 40-7). When the brake is applied the ladder will lower automatically (fig. 40-5). The ladder will not raise (fig. 40-6) until the machine is running and the switch has been returned to the OFF position.



FIG. 40-5



FIG. 40-6



FIG. 40-7

IV. OPERATING SYSTEMS

C. HYDRAULIC SYSTEM

BASIC MACHINE

HYDRAULIC TREAD ADJUST– To adjust the tread width hydraulically (if equipped) follow the instructions below:

1. Survey the surroundings and allow yourself enough room to adjust the tread in either forward or reverse.
2. Locate the tread adjustment switches on the rear of the right hand console (fig. 41-1). They are marked LF (left front), LR (left rear), RF (right front), and RR (right rear). The legs may be moved in or out on each side independently*. While driving between one and two mph, press and hold the desired switches to move the tread in the desired direction. Pressing the top of the any switch will move that leg OUT and pressing the bottom of any switch will move that leg IN.
3. Observe the tread width on each leg. Front legs use indicator decals (fig. 41-2) while the rear legs use electronic sensors and the MDM in the cab (fig. 41-3) . Release the switch when the tread indicator reaches the desired tread marking.
4. After adjustment is complete, all four tread width indicators should have identical readings.
5. To recalibrate toe-in: while driving forward slowly, turn the steering wheel all the way one way until both steering cylinders bottom out; continue turning the wheel a little more to let fluid bypass the cylinder. Then turn the steering wheel all the way the other way and repeat the process. When wheels are then straightened, steering cylinders should be re-centered and correct toe-in should be obtained. This is referred to as “phasing”. (see Section G of Service and Maintenance)

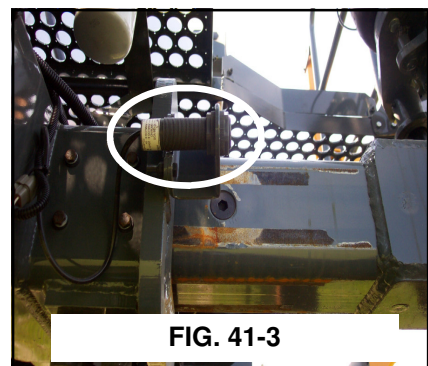
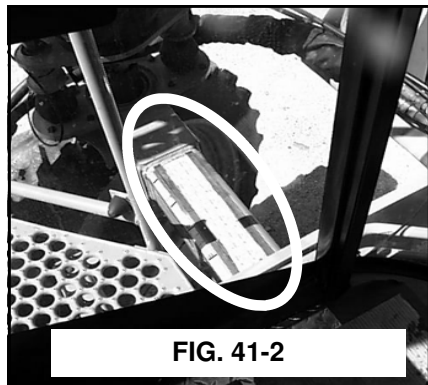
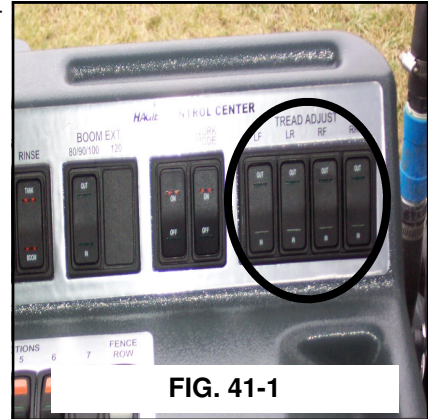

* When a significant adjustment is being made, it is recommended that you adjust one leg at a time and do the adjustment in smaller increments. Binding may occur if a larger adjustment is made all at once, especially if adjusting one leg at a time.

CAUTION

Never adjust the hydraulic tread on a public roadway. Make sure the sprayer is on level ground where there are no ditches or valleys to interfere when you perform the adjustment.

IV. OPERATING SYSTEMS

C. HYDRAULIC SYSTEM

SPRAY SYSTEM

- A. Solution Pump
- B. Boom Control Valve
- C. Spray Booms

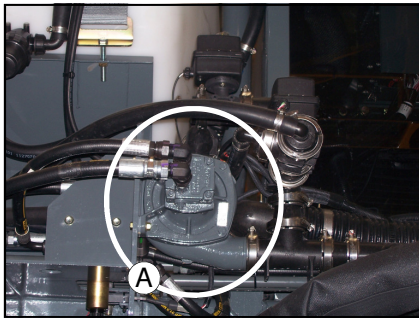

FIG. 42-3

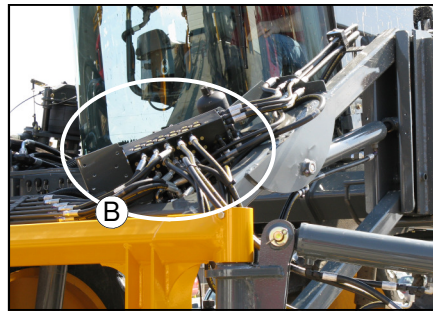

FIG. 42-3



FIG. 42-3

SOLUTION PUMP– The solution pump is a centrifugal pump controlled hydraulically with the pulse width modulated control valve. The valve is controlled by the Raven monitor per the calibration settings entered by the operator.

The solution pump is also used to distribute the water or cleaning solution from the rinse tank through the rinse systems.

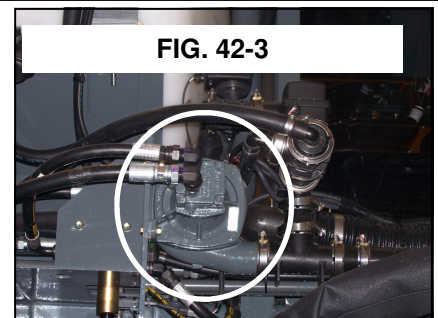

BOOM CONTROL VALVE– The boom control valve is the electro-hydraulic valve that controls the flow of hydraulic oil to the various boom cylinders. All the functions are controlled manually by the operator from inside the cab.

The valve is located on the boom lift-arm assembly.

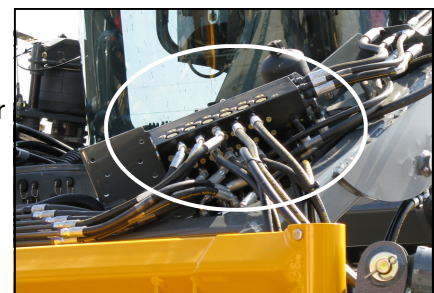

FIG. 42-3

IV. OPERATING SYSTEMS

C. HYDRAULIC SYSTEM

SPRAY SYSTEM

SPRAY BOOMS—Hydraulically folding the extensions of the 60/80/90 foot boom system and adjusting spray valves essentially turns it into a 60 foot boom. (continue reading this section for more information). Manually folding the outer extensions of the 60/80/90 foot system, adjusting spray valves and recalibrating the spray monitor essentially turns it into an 80 foot boom (see the section on operating the spray system and the section on calibration for more information on the monitor).

The spray booms are controlled by an electro-hydraulic system. This system consists of operator manipulated switches located in the sprayer's cab and hydraulic cylinders attached to the booms. It provides control of lift, level, horizontal extension, and vertical extension.

All STS spray booms are equipped with a hydraulic breakaway circuit. When folded out as an 80 or 90 foot spray boom, a one-way hydraulic circuit on the outer boom section provides outer boom breakaway functions. The outer breakaway is self-resetting and will return to normal operating position after it has cleared the hazard (fig. 43-1).

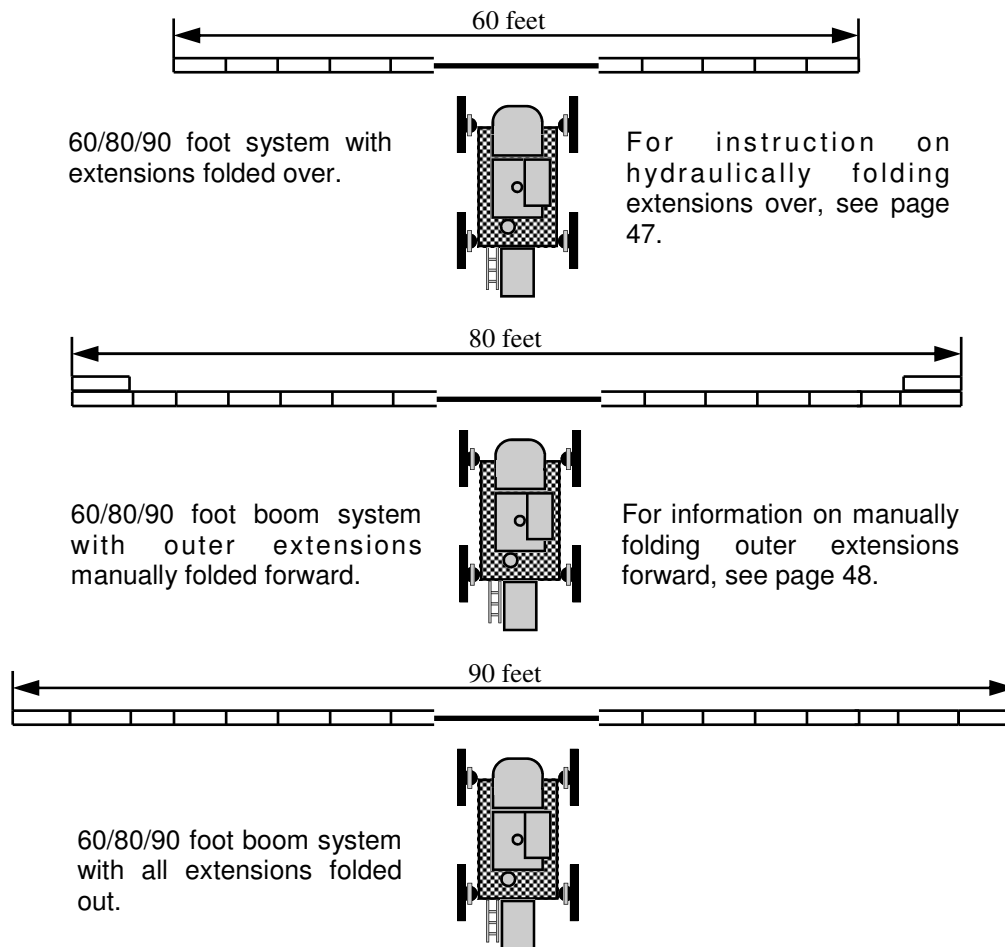

IV. OPERATING SYSTEMS

C. HYDRAULIC SYSTEM

SPRAY SYSTEM

Lift

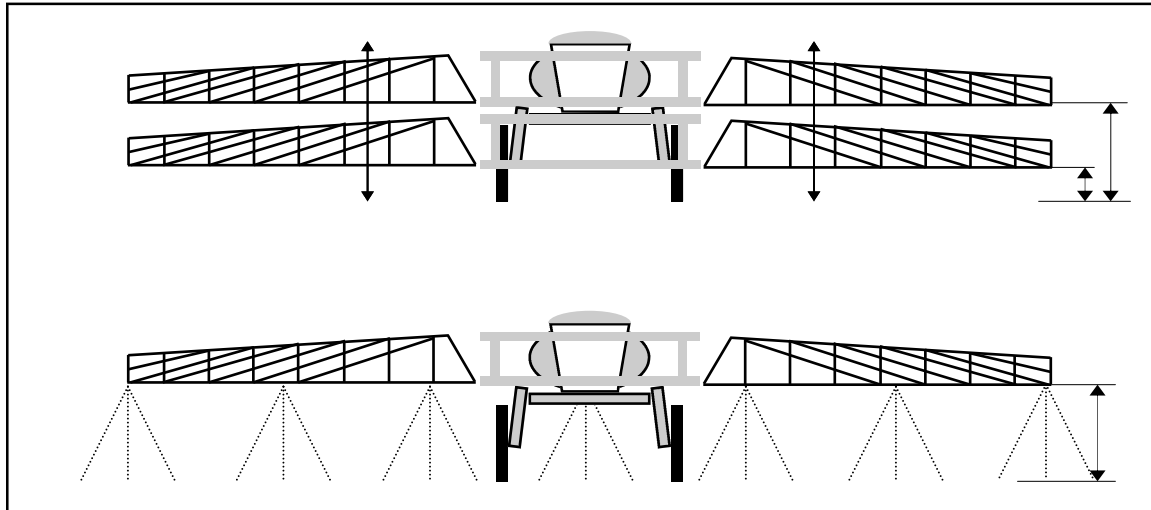

FIG. 44-3

NOTE:

See your spray tip manufacturer's guide for information regarding spray tip height (fig. 44-3).



FIG. 44-1

To raise and lower the transom/boom assembly, depress the "square rocker" on the hydrostatic lever (fig. 44-1) and move it either UP or DOWN. While pressed, it will activate the transom lift cylinders (fig. 44-2).



FIG. 44-2

IV. OPERATING SYSTEMS

C. HYDRAULIC SYSTEM

SPRAY SYSTEM

Level

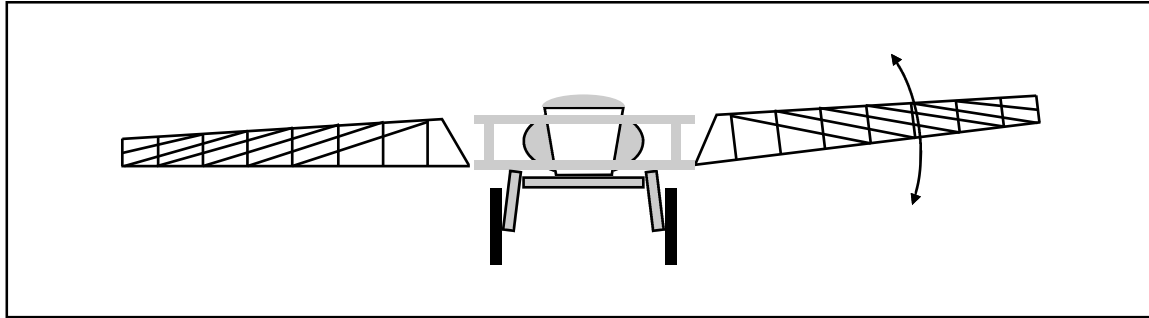

FIG. 45-1

To increase or decrease the angle of each individual boom level, depress the left or right “Round Rocker” UP or the left or right “Round Rocker” DOWN buttons on the hydrostatic lever (fig. 45-3). While depressed, these buttons activate the level cylinders connecting either boom to the transom (fig. 45-2).

This adjustment also aids in placing the booms correctly in the cradles for transporting and storing.



FIG. 45-2



FIG. 45-3

IV. OPERATING SYSTEMS

C. HYDRAULIC SYSTEM

SPRAY SYSTEM

Horizontal Boom Extension

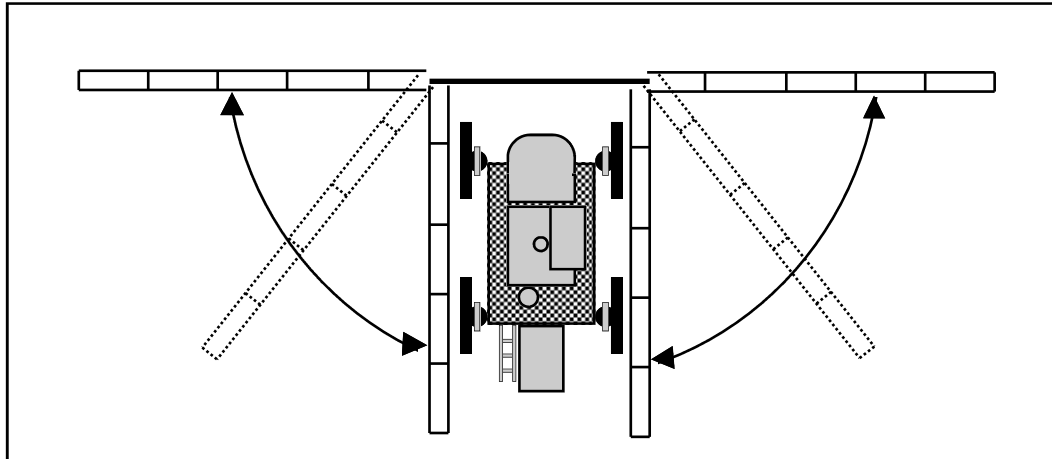

FIG. 46-1

To fold either boom horizontally in toward the machine or out, depress the right or left Rocker “Boom Fold” switches on the hydrostatic lever (fig. 46-3). While depressed, these switches activate cylinders connecting either boom to the transom (fig. 46-2).

Fold or unfold the booms in an open area only. Make sure no one is standing in the boom extension’s travel path. Booms can be folded if speed is less than 5MPH.



FIG 46-2



FIG 46-3

IV. OPERATING SYSTEMS

C. HYDRAULIC SYSTEM

SPRAY SYSTEM

Vertical Extension

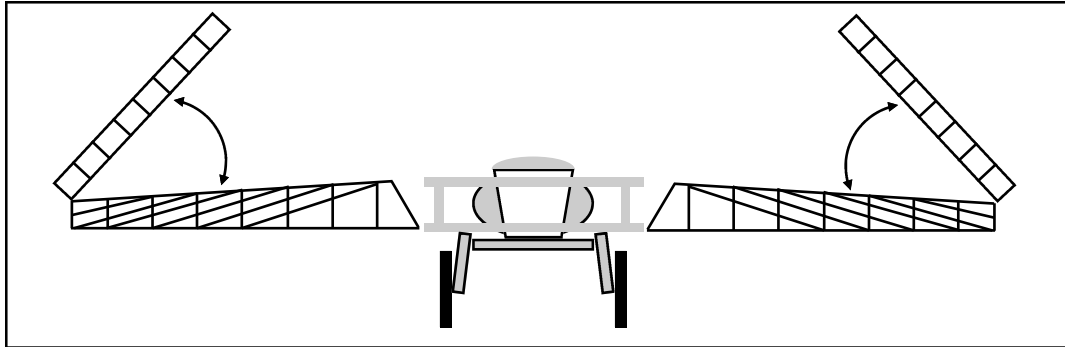

FIG. 47-1

NOTE:

Boom extensions can only be folded when hydrostatic control lever is in the neutral position, and you have pushed the **F1** or **ok** in the MDM showing you have acknowledged there are no power lines overhead. If sprayer is put in gear during folding, booms will stop.



To fold the boom extensions vertically in or out, depress the top or bottom of the **Boom Extension** switch (fig. 47-2). **This activates BOTH (right and left side) extension cylinders connecting the inner boom section and the center boom section** (fig. 47-3).

Fold or unfold the booms in an open area only. Make sure there are no overhead obstructions or wires to interfere with extension folding. The booms will vertically unfold even if they are still in the boom cradle or are not horizontally extended!

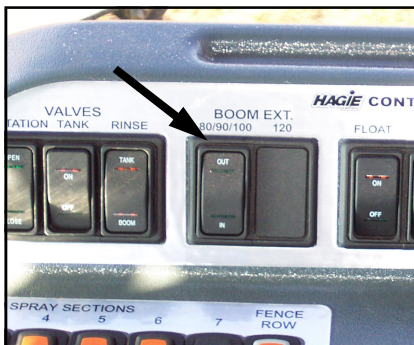

FIG 47-2



FIG. 47-3

IV. OPERATING SYSTEMS

C. HYDRAULIC SYSTEM

SPRAY SYSTEM

Manually Folding 90' Boom to 80' Boom

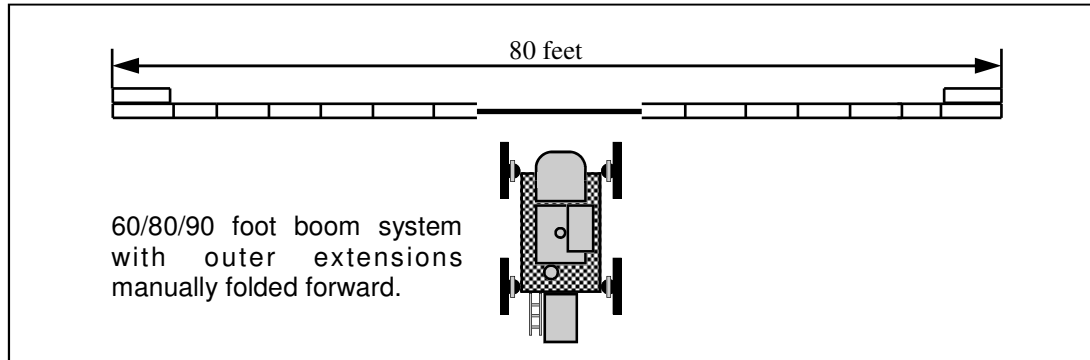

FIG. 48-1

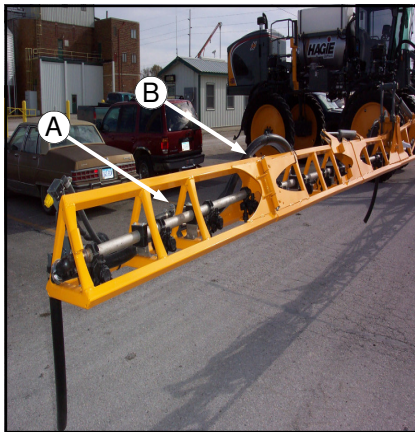

FIG. 48-2



FIG. 48-3



FIG. 48-4

To convert a 90 foot boom to an 80 foot boom, manually close the solution supply valve on the outer section (fig. 48-2, item A). Remove the pin on the back side of the boom (fig. 48-2, item B) so it will hinge forward (fig. 48-3) and secure it with the rear pin (fig. 48-4). Repeat these steps on the other side and recalibrate the monitor accordingly (see the Raven manufacturer's guide) before spraying resumes. See page 78 regarding foam marker adjustment.

IV. OPERATING SYSTEMS

C. HYDRAULIC SYSTEM

DETASSELING SYSTEM

- A. Quad Puller Assembly
- B. Cutter Head Assembly
- C. Relief Manifold
- D. Electro-hydraulic Lift Control Valve
- E. Hydraulic Outrigger Fold Valve
- F. Motor Control Valve
- G. Lift Cylinders

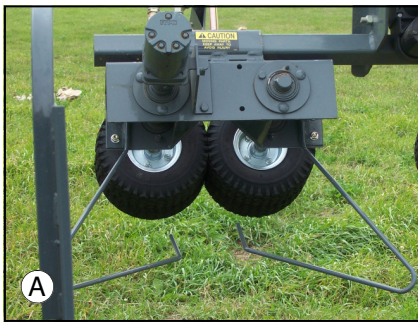

FIG. 49-1



FIG. 49-2

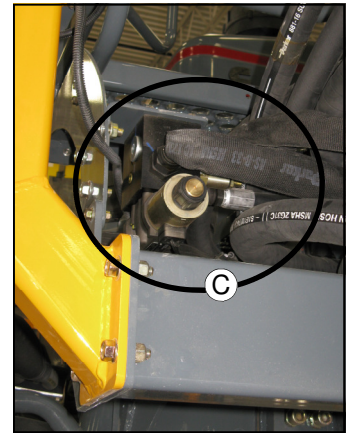

FIG. 49-3

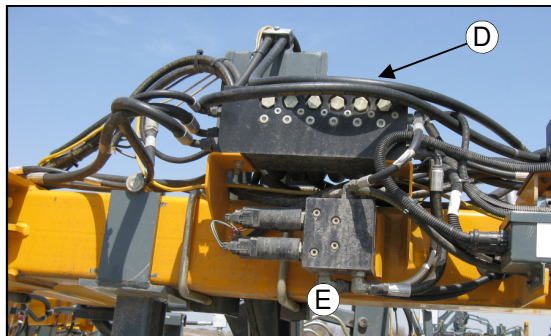

FIG. 49-4

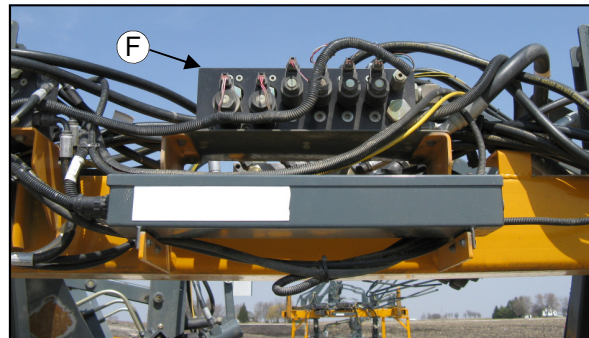

FIG. 49-5

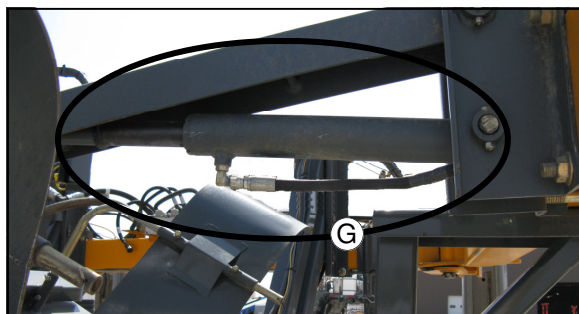

FIG. 49-6

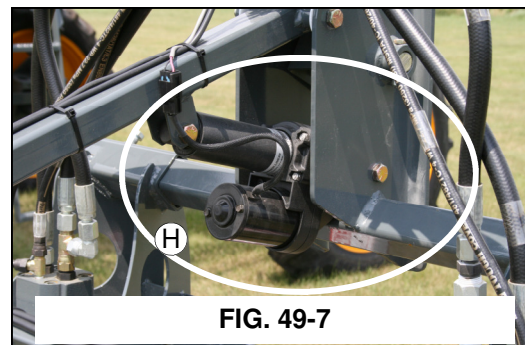

FIG. 49-7

IV. OPERATING SYSTEMS

C. HYDRAULIC SYSTEM

DETASSELING SYSTEM

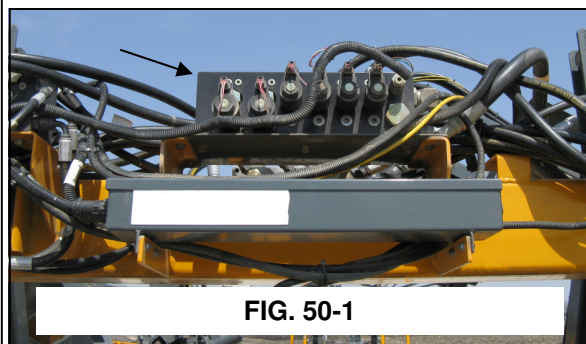

FIG. 50-1

MOTOR CONTROL VALVE— The motor control valve is an adjustable needle valve that controls the flow of hydraulic oil to the hydraulic motors of the detasseling heads.

The solenoids are opened using the switches on the combo control panel (fig. 50.2). Depress the top of the switch to turn them on, and the bottom of the switch to turn

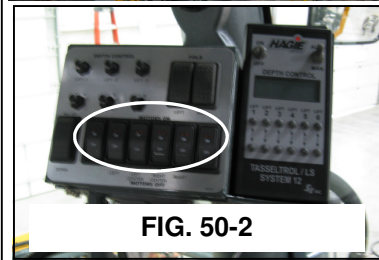

FIG. 50-2

them off.

The work mode switch on the side console and the main control switch on the hydrostatic lever must be activated for the hydraulic motors to work.

DETASSELING HEADS (QUAD PULLERS/ CUTTER HEAD)-

The detasseling heads (fig. 50-3, 50-4) each have a hydraulic motor that is responsible for the rotation of the wheels or blade. Careful attention must be paid to the flow direction when replacing hoses! Failure to properly attach hoses may result in personal injury or machine damage.

Each set of motors is individually turned on with a switch located on the combo control panel (fig. 50-5). The switches correspond with the lift sections (not the detasseling heads) from left to right when sitting in the operator's seat. If there are only four lifts, the first and last switch will not control anything.

Depress the top of the switch to activate the set of detasseling heads and the bottom of the switch to turn them off.

The motors are hydraulically driven in direct relation to engine RPM. This means that in order to have the optimal pressure for the motors the engine RPM must be maintained at 2500 RPM during operation. Continue reading the Operating Systems section for more information.

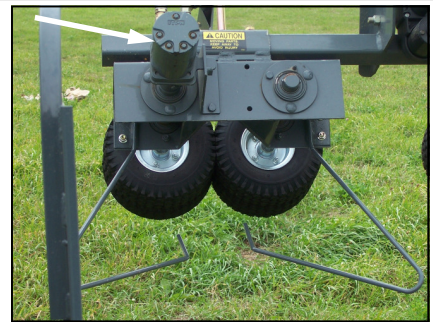

FIG. 50-3

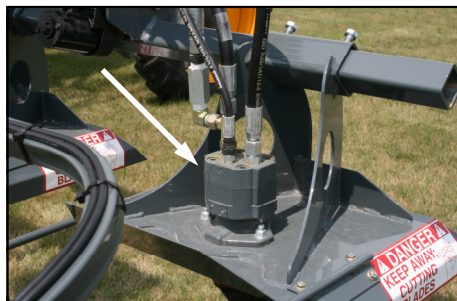

FIG. 50-4



FIG. 50-5

IV. OPERATING SYSTEMS

C. HYDRAULIC SYSTEM

DETASSELING SYSTEM

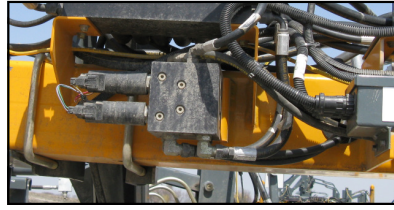
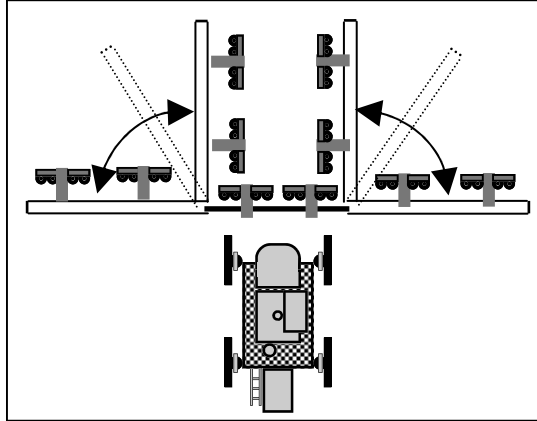

FIG. 51-1



FIG. 51-2

OUTRIGGER FOLD VALVE– The outriggers are hydraulically folded in and out by the operator using the LEFT or RIGHT FOLD switch on the combo console (fig. 51-2).

To fold the outriggers out, depress the bottom of the button. To fold the outriggers in, depress the top of the button. Do not operate the detasseling heads with the outriggers folded in.

RELIEF MANIFOLD– The relief manifold (fig. 51-3) controls the amount of hydraulic oil flow from the cooling system and into the auxiliary system when 3 or more lift sections (cylinders) are activated..

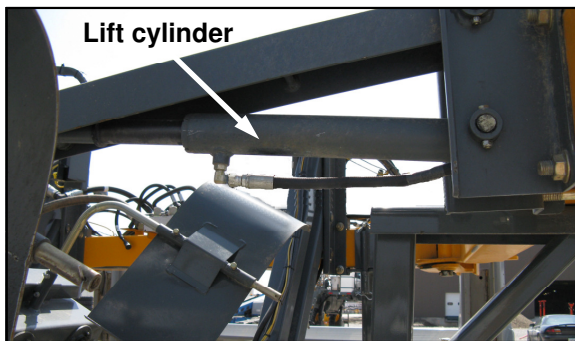

FIG. 51-4

Your lift cylinder assemblies (fig. 51-4) may or may not have flow control valves on them. At the time of publication, Hagie was in the process of converting to the .042" orifice in the lift control valve. The change gives the operator better control of the speeds in which the lifts operate and the evenness of their operation.

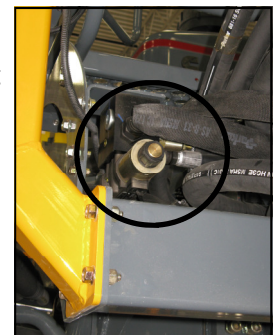

FIG. 51-3

ELECTRO-HYDRAULIC LIFT CONTROL VALVE–

The electro-hydraulic valve or lift valve (fig. 51-5) is located on the left hand side of the operator when seated in the operator's seat. It controls the lift cylinders in their upward and downward movements.



FIG. 51-5

IV. OPERATING SYSTEMS

C. HYDRAULIC SYSTEM

DETASSELING SYSTEM

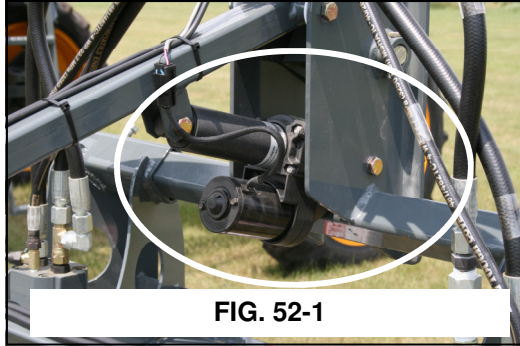

FIG. 52-1

DEPTH COMMAND– The depth command allows the operator to adjust the depth of the LS system from the operator’s seat. The switches are located on the combo switch panel (fig. 52-2). They are labeled Lift 1 through Lift 6. They correspond with the lifts from left to right while sitting in the operator’s seat. If there are only

four lifts, the switches in the first and last positions will not control anything.

To lower the cutting or pulling height, select the appropriate switch and push down. This will extend the actuator (fig. 52-1) raising the LS system, which in turn lowers the cutting or pulling height. To raise the cutting or pulling height, lower the LS system by pushing the appropriate switch up.



FIG. 52-2

IV. OPERATING SYSTEMS

E. SPRAY SYSTEM

Introduction



The spraying system is a constantly monitored and continuously adjusted computer controlled system. The cab mounted digital console receives information from various inputs to help determine GPM (gallons per minute) and GPA (gallons per acre).

In the following section, the components of the spray system will be explained. Please read the entire section before operating the STS spray system. This section is not designed to replace the Raven manual, the numbers may not reflect your specific situation. Read all manuals before operating this equipment.

Instructions

OPERATION

PAGE REFERENCE

1. Calibrate spray system console. 90-100 or Raven manual
2. Check contents and quantity in solution tank.

NOTE:

Never attempt to operate the spray system without solution in the spray tank. Operating the spray system with no solution in the tank will cause severe damage and void the warranty.

3. Start engine. 23, 37
4. Open tank valves, if desired, activate the agitation system. 63, 64
5. Turn on the WORK MODE switch. 26
6. Turn on the main spray power. 67
7. Place individual boom solution valve switches to the ON position. 67
8. Slowly move the hydrostatic lever forward to obtain the desired ground speed. 38
9. Frequently observe the pressure gauge. When it drops to zero, or spray pattern deteriorates, shut off main spray power, solution pump, and agitation system until refilling solution. 64, 63, 64, 65 or 66

IV. OPERATING SYSTEMS

E. SPRAY SYSTEM

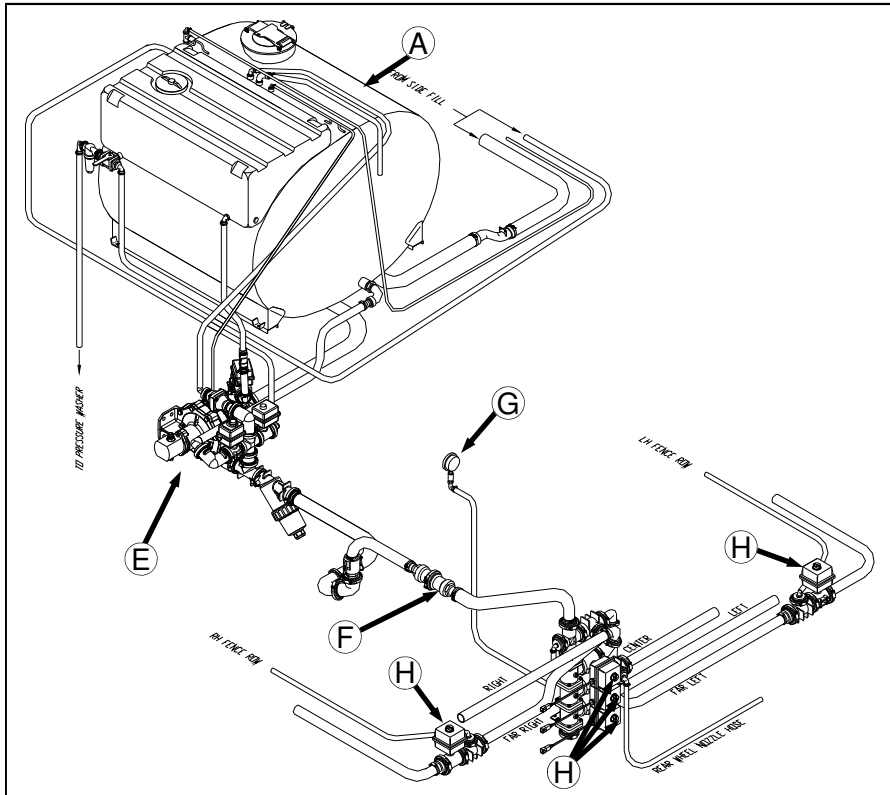

FIG. 62-1

- A. 1400g Stainless Steel Tank
- B. Solution Tank Valve
- C. Sump Valve
- D. Solution Tank Valve Switch
- E. Solution Pump
- F. Flow Meter
- G. Pressure Gauge
- H. Individual Solution Control Valves
- I. Agitation Switch
- J. Individual Spray Control Switches
- K. Main Solution Spray Control Switch

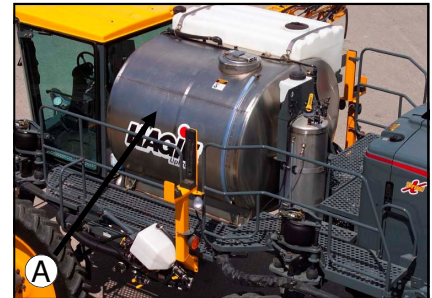

FIG. 62-1

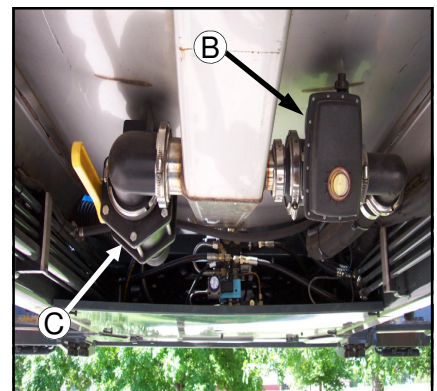

FIG 62-2



FIG. 62-4

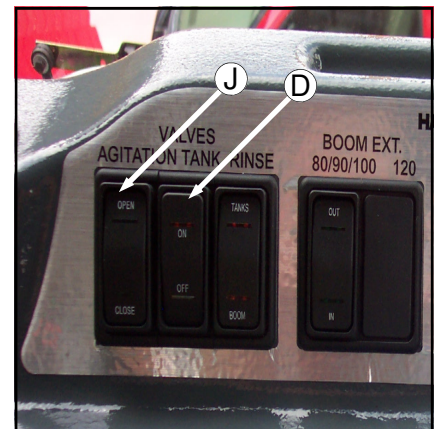

FIG 62-3



FIG. 62-5

IV. OPERATING SYSTEMS

E. SPRAY SYSTEMS

SOLUTION TANK– The stainless steel tank (fig. 4.3D-1), is 1400 gallon capacity. The tank has a sparge type agitation system.



FIG. 63-1

SOLUTION TANK VALVE– The solution tank valve (fig. 63-2, item A) controls the amount of solution coming out of the tank. The valve is controlled from inside the cab with the TANK VALVE switch (fig. 63-3) located on the right hand console.

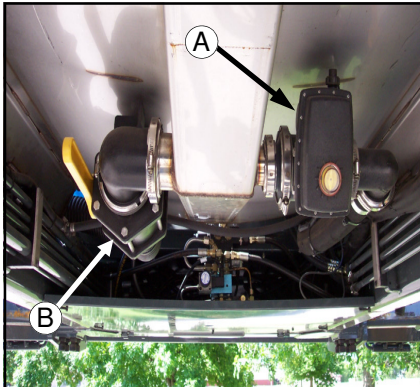

FIG 63-2

TANK SUMP VALVE– The tank sump valve (fig. 63-2, item B) is a ball type valve that has to be turned on and off manually. This valve is to allow the fluid into the tank from the fill option.

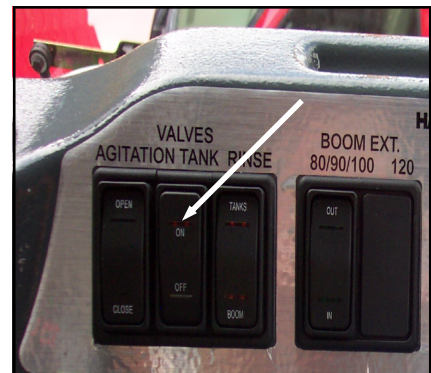

FIG 63-3

SOLUTION PUMP– The solution pump (fig. 63-4) is a centrifugal type hydraulic pump that is controlled by the Pulse Width Modulated Valve (fig. 63-5) and the Raven console (fig. 63-6). The pump draws the solution out of the tank at a rate determined during the calibration of the Raven console. It dispenses it through the many valves and hoses that make up the spray system. The pump also dispenses fluids through the agitation system and the rinse systems.

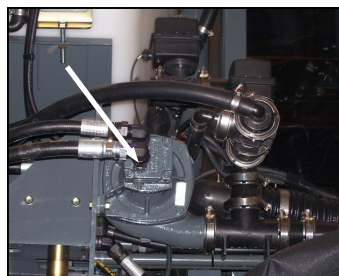

FIG. 63-4

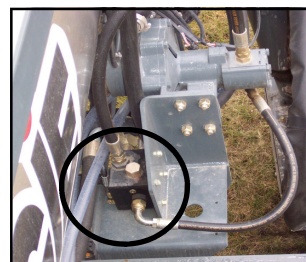

FIG. 63-5



FIG. 63-6

IV. OPERATING SYSTEMS

E. SPRAY SYSTEMS

SOLUTION PRESSURE GAUGE– The pressure gauge (fig. 64-1) gives you the operator a constant visual display of the amount of solution being applied (measured in PSI). The pressure, as determined by the pulse width modulated control valve, will vary according to ground speed. If applying solution manually, the solution pressure gauge visually informs the operator of needed manual adjustments. The gauge also shows when there is a drop in pressure indicating that the solution tank maybe empty or there is a problem with the system.

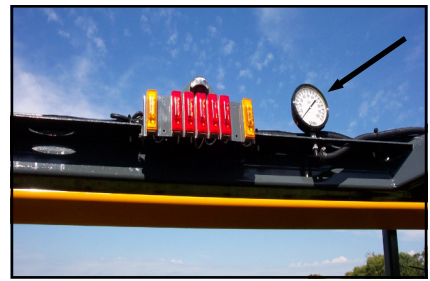

FIG. 64-1

FLOW METER– The flow meter located in the main solution line (fig. 64-2) monitors the solution flow and sends information back to the console and control valve. If the flow rate is not within the parameters programmed, the control valve will compensate by either opening or closing. If the rate continues to be outside the parameters an alarm will sound signaling a low flow rate. (See the Raven Console guide for more information on low flow limit)

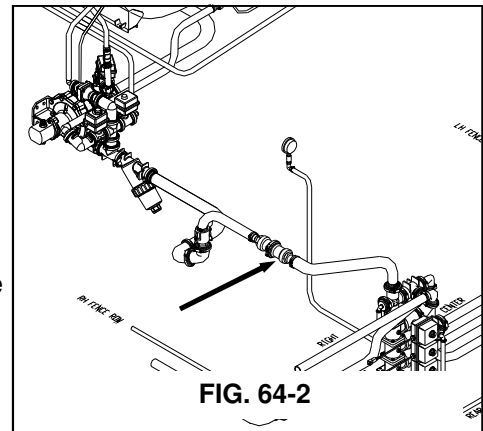

FIG. 64-2

AGITATION– The speed of the sparge agitation system is controlled by a variable flow solution valve (fig. 64-3, item 1) mounted on the solution pump (fig. 64-3, item 2). The agitation switch (fig. 64-4) on the right hand console controls the rate of flow through the sparge system. While watching the indicator on the agi-



FIG 64-4

tation valve, increase or decrease the flow rate with the control switch. To increase the flow, press the switch up. To decrease the flow, press the switch down. When the desired rate of flow is achieved, release the switch.

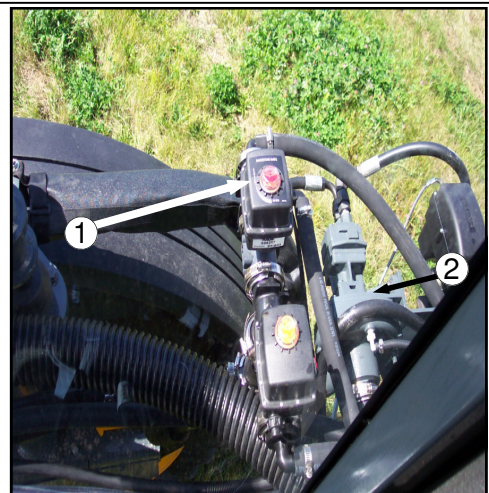

FIG. 64-3

To turn the sparge system off, decrease the flow rate all the way.

IV. OPERATING SYSTEMS

E. SPRAY SYSTEMS

SOLUTION QUICK FILL– To fill the solution tank, make sure the sump valve under the tank (fig. 65-1) is open. To access the front fill, pull the front fill latch lever down (fig. 65-2) and the assembly will lower (fig. 65-3). Connect it to your solution supply, fill to the desired level. You may also fill the rinse tank from the ground level with the owner supplied connection. When finished, shut all of the valves and return the front fill to the locked position. See the next page for information regarding the use of the side fill inductor for filling the solution tank.



FIG 65-1

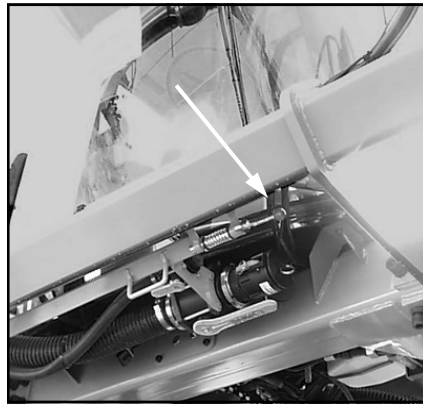

FIG 65-2



FIG. 65-3

IV. OPERATING SYSTEMS

E. SPRAY SYSTEMS

INDUCTOR OPERATION- With the engine running and the parking brake set, flip the lock switch up (fig.66-1,item A). Lower the inductor assembly with the inductor control box switch (fig. 66-1, item B). If filling with the suck-on attachment, leave the engine running. If filling with the push-on attachment, turn the engine off.

NOTE:
The following fill and rinse scenarios refer to figure 66-2 below.

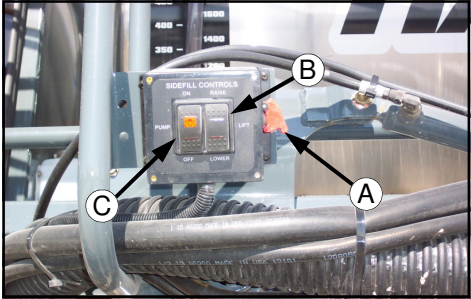

FIG 66-1

Load water only: B-connected, C- on, E-off, F-off.

Suck water only*: B-connected, C-on, E-off, F-off.

Load water/induct chem.: B-connected, E-open, F-off.

Suck water/induct chem.*: B-connected, E-open, F-off.

Fill rinse tank: A-handle perpendicular to sprayer.

Rinse inductor tank with rinse tank: F- valve on.

Rinse inductor tank with nurse tank (suck or load): F-valve on, E-valve on.

*To activate “suck-on” pump, flip the inductor control switch up (fig. 66-1, item C). This will start the pump. Flip switch down when filling is complete.

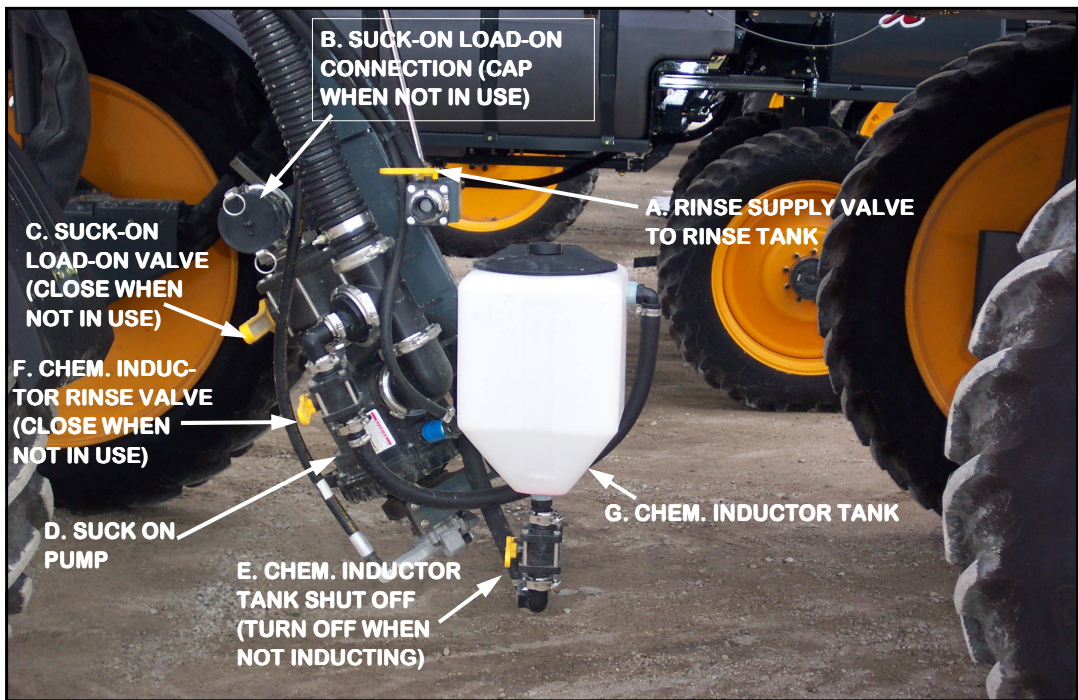

FIG 66-2

IV. OPERATING SYSTEMS

E. SPRAY SYSTEMS

BOOM SOLUTION VALVE SWITCHES– The spray booms are divided into sections that are independently supplied with solution and can therefore be shut off or turned on independently. The electronic boom solution valves are controlled by a row of switches mounted on the right hand console (fig. 67-1).



FIG. 67-1

Sixty foot boom configurations are divided into three sections and the valves are mounted on the transom. Eighty and ninety foot booms are divided into five sections with three of the valves mounted on the transom and one mounted on each boom.

BOOM SOLUTION VALVE L.E.D. INDICATORS– Boom solution valve status is displayed on the transom by a series of L.E.D. indicators (fig. 67-2). Each indicator light will illuminate if that particular boom solution valve is turned **OFF**.

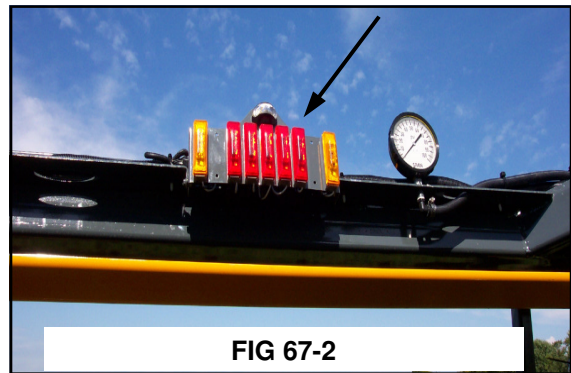

FIG 67-2



FIG. 67-3

MAIN SOLUTION SWITCH– Main spray power can be controlled from a switch on the hydrostatic lever (fig. 67-3). This controls the panel of boom solution valve switches. The main switch must be on to supply the individual switches with voltage. This allows you to turn all of the boom solution valves ON or OFF at the same time such as turning it off when you arrive at the end rows of a field and turning it back on when you re-enter the field. The individual switches allow you to turn the valves on or off separately.

When the main spray power is ON a green indicator light mounted on the right side of the message center (fig. 67-4) will illuminate and a

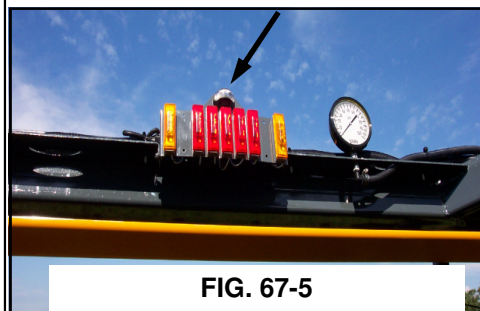

FIG. 67-5

white indicator light mounted on the transom assembly (fig. 67-5) will illuminate also.

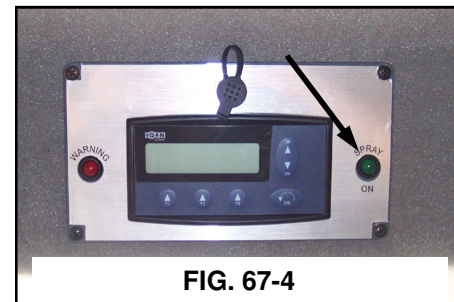

FIG. 67-4

NOTE:

DO NOT allow the pump to keep running when the boom switches are turned off. Failure to do so will generate in over-heating and cause severe pump damage and void the warranty.

IV. OPERATING SYSTEMS

E. SPRAY SYSTEMS

FENCE ROW APPLICATOR– To operate the fence row nozzle, locate the fence row switch on the console (fig. 68-1) If you wish to turn on the right fence row nozzle, depress the top of the fence row switch. To turn on the left fence row, depress the bottom of the switch. To turn either fence row nozzle off, return the switch to the center position.



FIG. 68-1

As you engage either fence row you may notice a drop in solution pressure.

A pair of amber L.E.D. lights mounted on the transom (fig. 68-2), on either side of the boom solution valve indicator lights, will inform the operator of fence row status. If the left fence row nozzle is ON, the left amber L.E.D. light will be on. If the right fence row nozzle is ON, the right amber L.E.D. light will be on. If neither amber L.E.D. light is on, there is no solution being applied through the fence row nozzles.

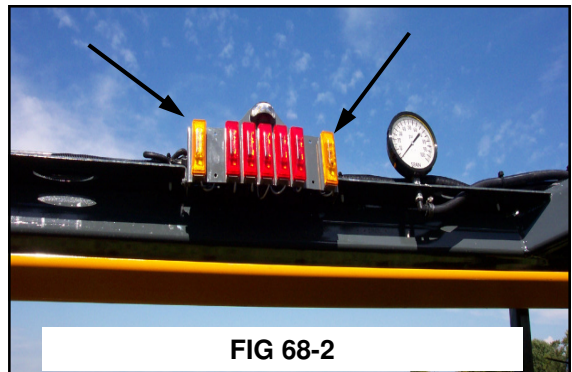

FIG 68-2



FIG 4.36-3

HAND WASHING SYSTEM– Fill the hand wash tank (fig. 68-3) with fresh water only! The hand wash valve is located under the left side of the sprayer (fig. 68-4). Remember to close the valve before refilling.

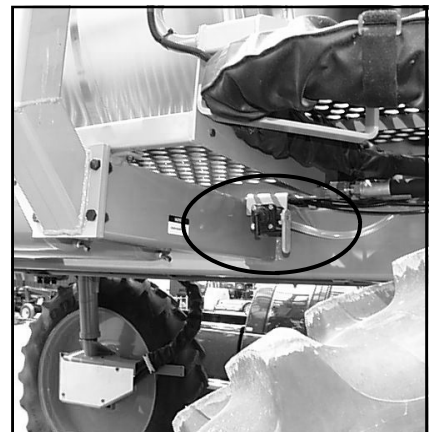

FIG 68-4

NOTICE

FILL WITH FRESH WATER ONLY

650114

NOTICE

HAND WASH ONLY

650115

IV. OPERATING SYSTEMS

E. SPRAY SYSTEMS

RINSE SYSTEM OPERATION– Activate the system only after solution tank is empty. Select a safe area to rinse the spray system and clean sprayer where the chemicals will not drift off to contaminate people, animals, vegetation, or water supply. Refer to chemical manufacturer’s guide for types of cleaning solution combinations (plain water, cleaning agents, etc.).

TO RINSE SOLUTION TANK AND 3” FILL LINES:

The solution pump is controlled by the Raven console (fig. 69-1)

1. Turn on spray system console. Turn the rate switch to the MANUAL position. Using the flow increase/decrease lever, increase the solution pressure to maximum PSI.
2. Close the solution tank valve (fig. 69-2).
3. Depress the “SOLU TANK” rinse switch (fig. 69-2, item C).
4. When finished rinsing the solution tank, return the rinse switch back to the OFF position and turn the spray system OFF (including the solution pump switch, and console).



FIG. 69-1

TO RINSE BOOM SUPPLY AND NOZZLES:

1. Follow steps 1 and 2 from above.
2. Turn agitation OFF (fig. 69-2, item A).
3. Close solution tank valve (fig. 69-2, item B) and open boom supply valves (fig. 69-2, item D).
4. Depress the “BOOM” rinse switch (fig. 69-2, item C).
5. When finished rinsing the boom, return the rinse switch back to the OFF position and turn the spray system OFF (including the solution pump switch, console, boom solution valves, and main spray power switch)

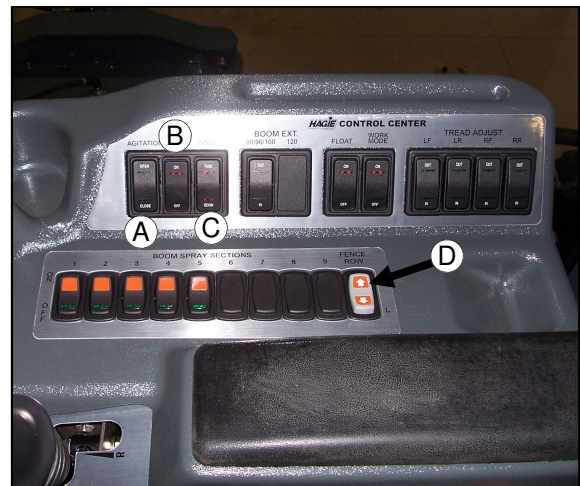

FIG 69-2

IV. OPERATING SYSTEMS

E. SPRAY SYSTEMS

FOAMER OPERATION– To operate the foam marking system, locate the toggle switch on the top of the hydrostatic lever (fig. 70-1). Push the top of the switch left if foam is desired from the left foam drop. Push the top of the switch right if foam is desired from the right foam drop. Return the switch to the center position if no foam is desired.



FIG. 70-1



FIG. 4.38-2

System pressure is indicated by a pressure gauge on the regulator which is mounted next to the foam tank (fig. 70-2) To adjust the air pressure in the foam tank, turn the knob on the regulator clockwise for more pressure, and counterclockwise for less pressure. To correctly decrease the pressure in the foam tank, you must first open either the left or right foam valve for a moment to relieve system pressure. Then adjust regulator accordingly.

See figure below for foam drop valve configurations.

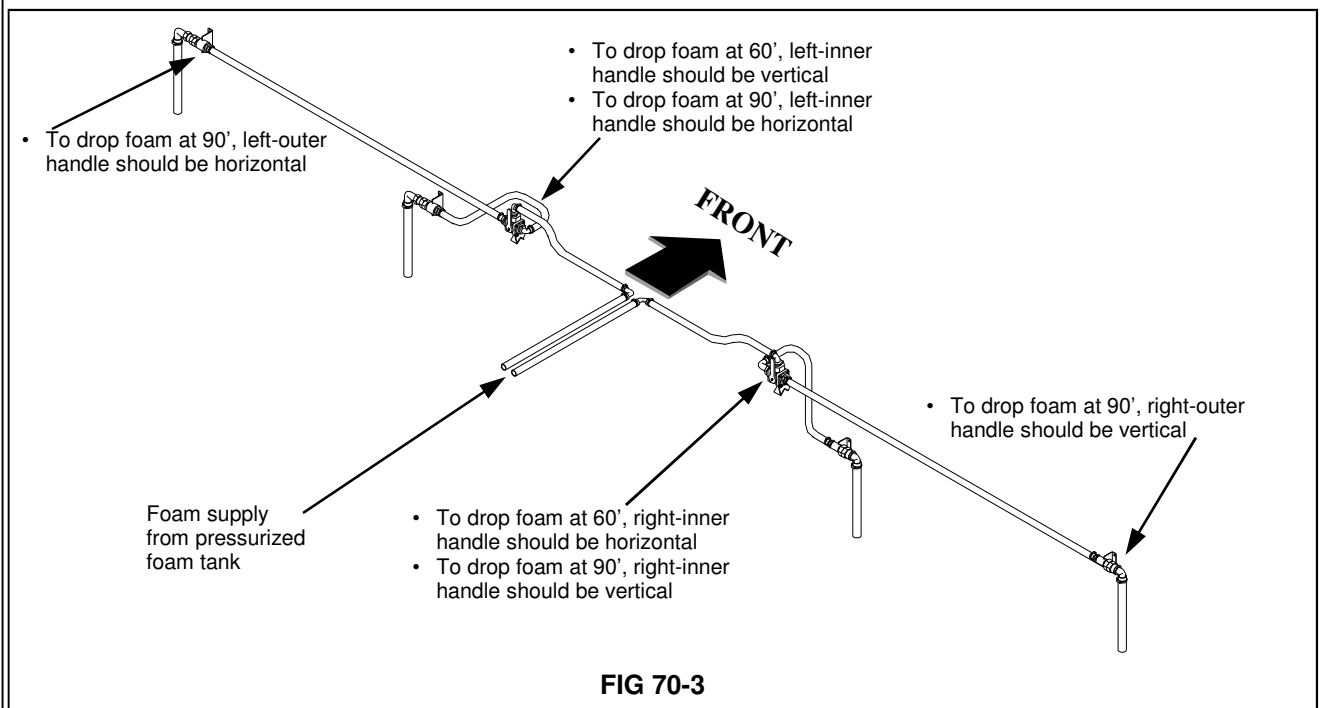

FIG 70-3

IV. OPERATING SYSTEMS

E. SPRAY SYSTEMS

FILLING THE FOAM MARKER SYSTEM– Relieve pressure from the foam tank by opening the ¼” ball valve on the side of the foam tank (fig. 71-1, item B). Close the ball valve after pressure is relieved. Open the top 2” ball valve (fig. 71-1, item A). Add water to the tank, leaving enough room for the foam concentrate. Next add the foam concentrate according to the label on the container. After filling is complete, close the 2” ball valve on top of the tank. Start the sprayer’s engine and adjust the air pressure accordingly (see previous page).

CAUTION

Before performing any service or refilling of the foam marker, shut the engine off and relieve system pressure from the tank.

WARNING

DO NOT stand directly over or in front of valves when opening.

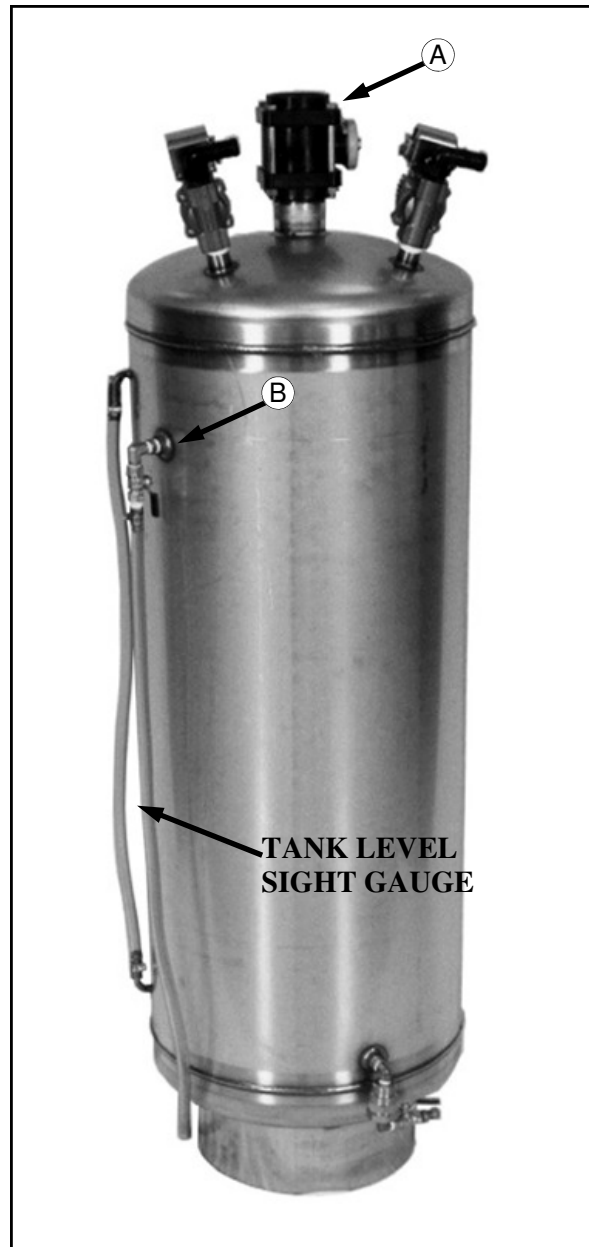

FIG 71-1

IV. OPERATING SYSTEMS

F. DETASSELING SYSTEM

Introduction



The detasseling system is a constantly monitored and a continuously adjusted system. The cab mounted control system receives data from photo light sensors to determine the detasseling height.

In the following section, the components of the detasseling system will be explained. Please read the entire section before operating the STS Combo option.

Instructions

OPERATION	PAGE REFERENCE
1. Program the Hagie Tasselrol®/LS System control box.	91-104
2. Test the photo light sensors.	78

NOTE:

Operating the system below the recommended the 2500 engine RPM will not provide the system with adequate hydraulic oil flow and may cause degraded or poor performance.

3. Start engine.	25, 39
4. Turn on the WORK MODE switch.	26
5. Turn on desired detasseling head motors.	50
6. Activate the MAIN CONTROL switch on the hydrostatic lever.	27
7. Shut the system down if there is a loss of hydraulic pressure or low oil warning. Failure to do so will result in system damage and void the warranty.	39

IV. OPERATING SYSTEMS

F. DETASSELING SYSTEM

To immediately achieve the recommended engine RPM and make the hydraulic detasseling motors available for use, you must over-ride the system. **This is not recommended for use with anything other than the detasseling system!**

To override the system:

1. Take the engine up one bump on the throttle switch (fig 73-1, item A) to 1800 RPM.
2. With the hydrostatic lever in neutral, press both the red and green buttons (fig. 73-1, item B) at the same time. This will bump the engine RPM directly to the recommended 2500.

To disengage the override, reduce the engine RPM by taking the engine down one bump on the throttle switch. A decrease in engine RPM will automatically disengage the override.

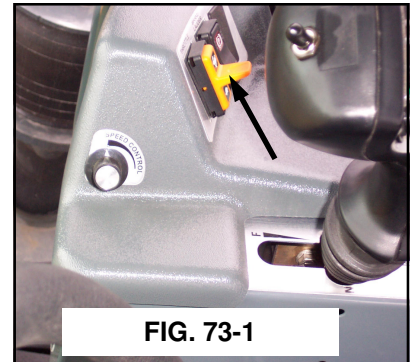

FIG. 73-1



FIG. 73-2

IV. OPERATING SYSTEMS

F. DETASSELING SYSTEM

- A. Combo Attachment
- B. Puller Heads
- C. Cutter Heads
- D. LS System/Depth Command
- E. Photo light Sensor
- F. All-Up Control Button
- G. Tasselrol Box
- H. Combo Control Panel
- I. Main Control Switch



FIG 74-1



FIG 74-2

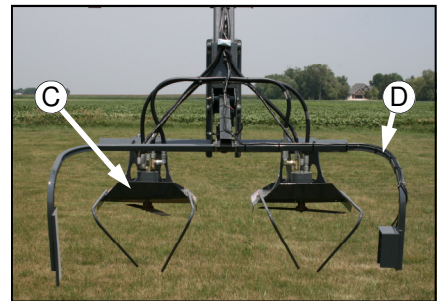

FIG 74-3



FIG 74-4

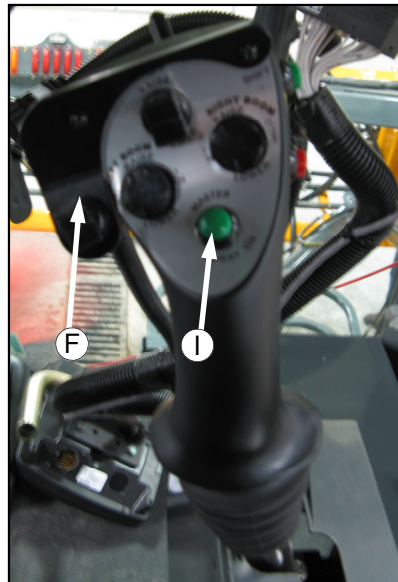

FIG 74-5



FIG 74-6

IV. OPERATING SYSTEMS

F. DETASSELING SYSTEM

QUAD PULLERS-



FIG 75-1

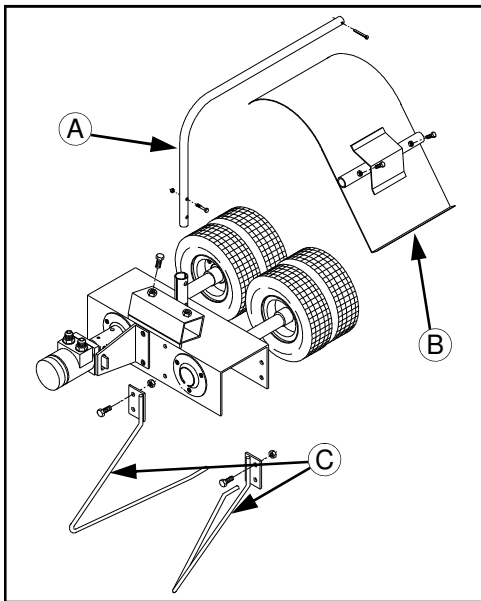

FIG 75-2

1. Attach the quad pullers to each lift arm tool bar.

NOTE:

Some quad pullers may come pre-assembled to the tool bar. In this case, you would attach them to the lift assembly.

2. Install the stalk guides to the quad puller head assembly (fig. 75-2, item C).
3. Attach the deflector shield mount tube (fig. 75-2, item A) and the deflector shields for right or left hand deflection (fig. 75-2, item B).
4. Refer to parts manual for hydraulic hose diagram.
5. Adjust tire pressure to approximately 10 pounds.



NOTE:

Be sure all four tires have equal pressure. Check tire pressure daily.

IV. OPERATING SYSTEMS

F. DETASSELING SYSTEM

CUTTER HEADS-



FIG 76-1



1. Attach the cutter head assembly to the tool bar.

NOTE:

Some cutters may come pre-assembled to the tool bar. In this case, you would attach the assembly to the lift assembly.

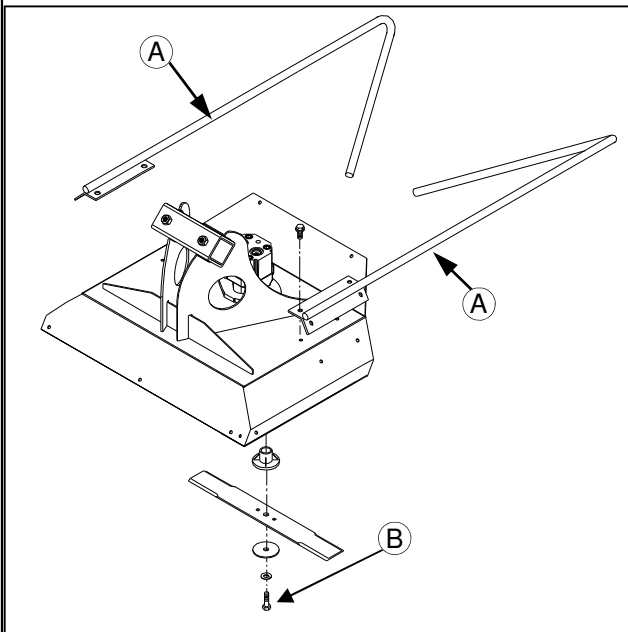

FIG 76-2

2. Install the stalk guides to the cutter head assembly (fig. 76-2, item A). Refer to the Hagie STS Combo Parts Manual for the proper hardware.
3. Check and tighten, if necessary, the retaining bolt (fig 76-2, item B).
4. Refer to parts manual for hydraulic hose diagram.



IV. OPERATING SYSTEMS

F. DETASSELING SYSTEM

LS SYSTEM AND DEPTH COMMAND-

1. Install Tasselrol®/LS sensor mount support weldment with the two nylon washers (fig 77-1, item B) in the forward-most hole of the tool bar (fig. 77-1, item A).
2. Install the Tasselrol®/LS sensor mount weldment (fig. 77-1, item C) to the sensor mount support arm.
3. Install the cable assembly according to the wire diagram in the Hagie STS Combo Parts Manual.
4. Turn the ignition key switch to the "ON" position to check the sensor installation. DO NOT start the engine.
5. Attach the depth command actuator (fig. 77-2) to the light sensor mount and the tool bar.

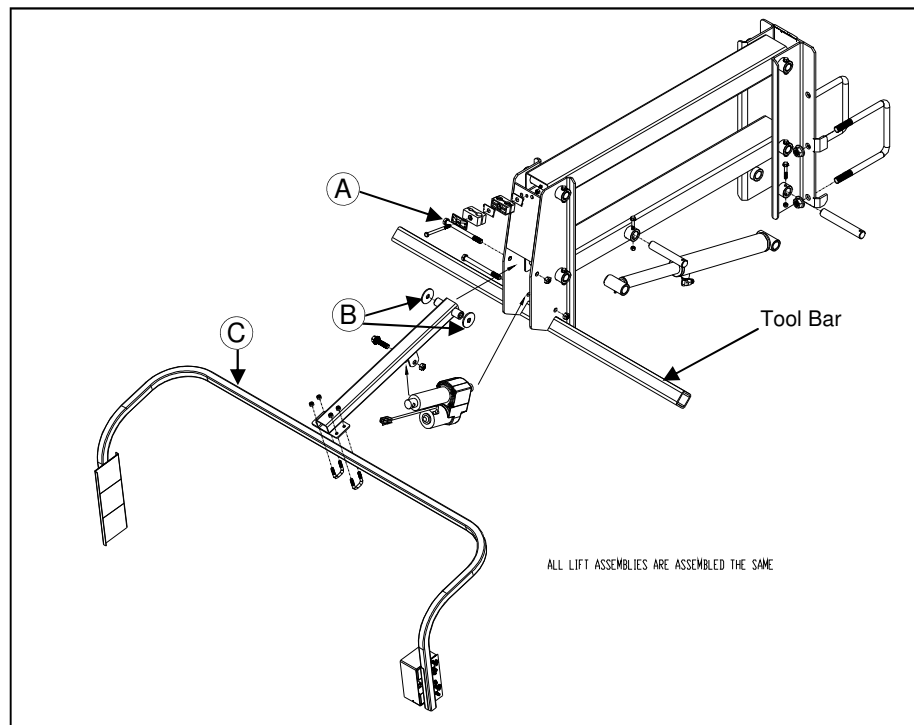

FIG 77-1

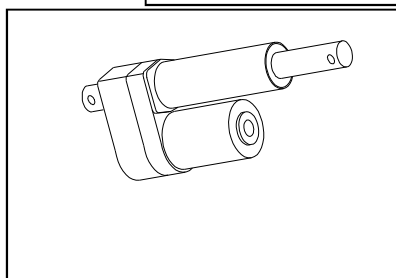

FIG 77-2

NOTE:

Over tightening of the sensor arm pivot mounting bolt (fig. 77-1, item A) may cause the actuator to stall.

IV. OPERATING SYSTEMS

F. DETASSELING SYSTEM

LS PHOTO LIGHT INDICATORS

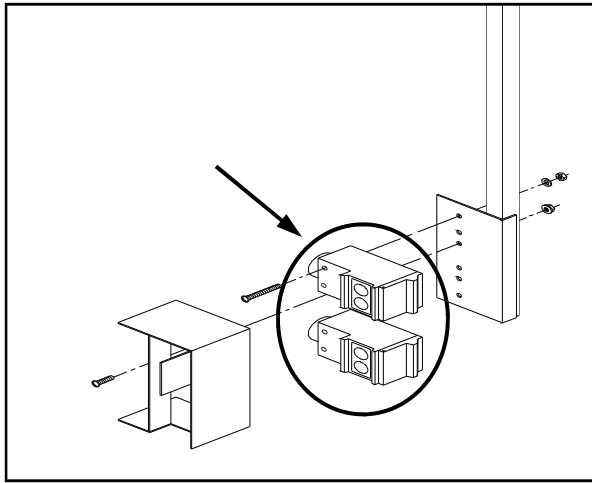

FIG 78-1



FIG 78-2

The upper and lower LS photo lights (fig. 78-1) have L.E.D. lights (fig. 78-3) that indicate their operational status.

LT/DK SWITCH – Light/Dark switch on photo light (fig. 78-3, item A) changes the activated condition of green L.E.D. (see below) from ON (“LT”) to OFF (“DK”). Switch does not affect the functional operation of the light, only how it is displayed. Switch should be set to “LT”.

SENSITIVITY ADJUSTMENT SCREW – Sensitivity adjustment screw (fig. 78-3, item B) should always be set to maximum.

YELLOW L.E.D. – Yellow L.E.D. (fig. 78-3, item C) indicates power on.

GREEN L.E.D. – Green L.E.D. (fig. 78-3, item D) indicates output energized (sending a signal to Tasselrol[®] box, opening the raise or lower stack valve).

RED L.E.D. – Red L.E.D. (fig. 78-3, item E) indicates photo light is receiving reflected signal.

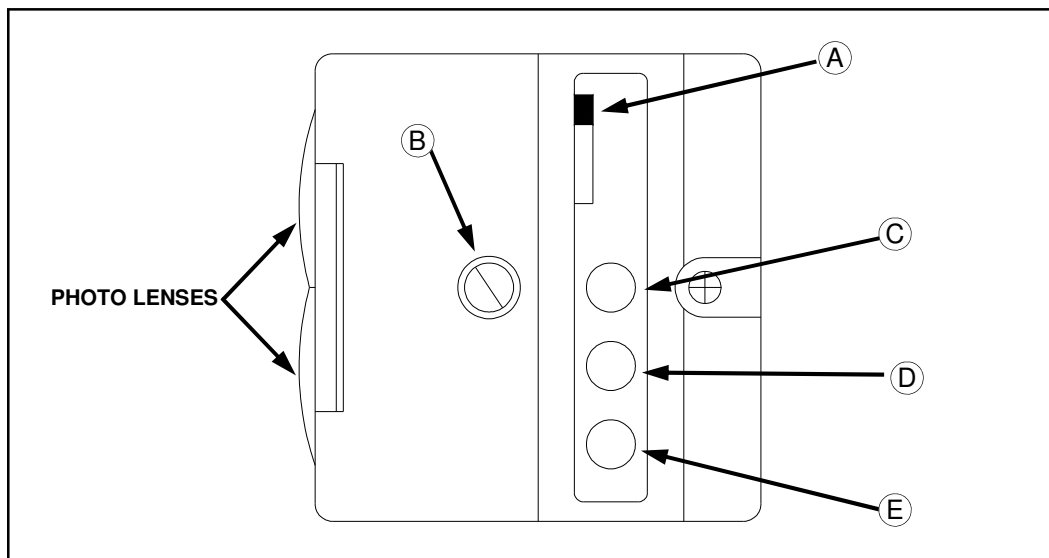

FIG 78-3

IV. OPERATING SYSTEMS

F. DETASSELING SYSTEM



FIG. 79-1

ALL-UP/HOLD BUTTON-The ALL-UP/HOLD button on the hydrostatic lever (fig. 79-1) is used to raise or lower all row units at the same time. There is a switch also located on the control panel (fig. 79-2) that is the same as the one on the hydrostatic lever.

Depress the top of either button to raise all the row units. Depress the bottom of the switch to lower all the row units.

Learn how to program the parameters of these switches in the section on PROGRAMMING.



FIG. 79-2



FIG. 79-3

TASSELTROL®-The Hagie Tasselrol® /LS System control box is used for the programming of the detasseling heads as well as the depth command system. This control box can also be used to control the detasseling heads manually. See the section on PROGRAMMING for more information.



FIG. 79-4

COMBO CONTROL PANEL-The combo unit's control panel houses most of the switches for the detasseling system. More information on the functions of the switches can be found in the Hydraulics section.

None of the functions of the detasseling system will function if the WORK MODE switch on the side console is not activated.

V. SYSTEM PROGRAMMING

A. RAVEN CONSOLE (SPRAYER)

INTRODUCTION

It is important to apply chemicals as recommended by the manufacturer's of the product. In order to do so, the spraying system must be properly calibrated.

Determine the speed at which the sprayer will be driven while applying the chemicals. To select the best speed, consider the lay of the land, the condition of the soil, the type of crops, the height of the crops, etc.

Select the nozzles spacing (distance between each nozzle on the spray boom) best suited for the intended spraying job. For help in determining the nozzle spacing and height of the boom, refer to the Spray Product Catalog that accompanies this manual.

There are several types and sizes of nozzles. Select (as recommended by the catalog) and install the type and size of nozzles best suited for the intended spraying job. The type of nozzle will be based on the product being sprayed and the type of crop it is being use on. The size of nozzles selected will be based upon the speed the sprayer will travel, the nozzle spacing, and the number of gallons one intends to apply per acre.

IMPORTANT:

**The key to an effective spray job starts with
the selection of the spray tip!**

Refer to the Spray Product Catalog that accompanies this manual for more information.

TIP SELECTION:

There are several things to consider when selecting the type of nozzle you need for the intended spray job. Whatever your personal preference is, be sure that the nozzle complies with the chemical manufacturer's standards for spray control and also any environmental standards that might be in place for your region.

(Some regions may have restrictions on "drift" control)

Once you have chosen a type of nozzle, you must choose the size of the nozzle. There are **3** main things to consider when choosing the size: **1)** recommendation of gallons per acre by the chemical manufacturer, **2)** the speed in which you intend to travel across the field while spraying, **3)** and the nozzle spacing (distance between tips).

See the next page for information on how to use this information to select a tip size.

V. SYSTEM PROGRAMMING

A. RAVEN CONSOLE (SPRAYER)

Since all the tabulations in the catalog are based on spraying water, you will need to use a conversion factor when spraying liquids are a different weight than water. This information is found in the Spray Products catalog.

Below is an example of how to choose the proper nozzle:

Joe is spraying 28% nitrogen. The chemical manufacturer recommends that the chemical be sprayed at 20 GPA. Joe knows that he can run his sprayer at 10 MPH across his field. He has a 20" nozzle spacing on his booms. Joe has narrowed his tip search to the flat spray tips.

Using the following conversion formula:

$$20 \text{ GPA (liquid other than water)} \times 1.13 \text{ (conversion factor)} = 22.6 \text{ GPA (water)}$$

Joe determined that he needs an application rate of 22.6 GPA to determine the correct nozzle to apply 28% nitrogen at 20 gallons per acre.

To figure out which nozzle is better for his use, Joe has to figure out the GPM he needs to spray.

$$\text{GPM} = \frac{\text{GPA} \times \text{MPH} \times \text{Spacing}}{5940} \rightarrow \text{GPM} = \frac{22.6 \times 10 \times 20}{5940} \rightarrow \text{GPM} = \frac{4520}{5940} \rightarrow \text{GPM} = 0.76$$

The nozzle that best matches the specifications set by Joe is the TP8008, spraying 22 GPA at a rate of 0.75 GPM. If Joe maintains a constant speed, he should have a successful chemical application.

FLAT SPRAY TIPS

NOZZLE SIZE	PSI	DROP SIZE		CAP. 1 NOZZLE IN GPM	CAP. 1 NOZZLE IN OZ./MIN	GPA							
						MPH							
						4	5	6	8	10	12	15	20
TP8004	30	M	M	0.35	45	26	21	17.3	13.0	10.4	8.7	6.4	5.2
	35	M	M	0.37	47	27	22	18.3	13.7	11.0	9.2	7.0	5.5
	40	M	M	0.40	51	30	24	19.8	14.9	11.9	9.9	7.4	5.9
	50	M	F	0.45	58	33	27	22	16.7	13.4	11.1	8.3	6.7
	60	M	F	0.49	63	36	29	24	18.2	14.6	12.1	9.1	7.3
TP8005	30	C	M	0.43	55	32	26	21	16.0	12.8	10.6	8.5	6.4
	35	M	M	0.47	60	35	28	23	17.4	14.0	11.6	9.3	7.0
	40	M	M	0.50	64	37	30	25	18.6	14.9	12.4	9.9	7.4
	50	M	M	0.56	72	42	33	28	21	16.6	13.9	11.1	8.3
	60	M	F	0.61	78	45	36	30	23	18.1	15.1	12.1	9.1
TP8006	30	C	M	0.52	67	39	31	26	19.3	15.4	12.9	10.3	7.7
	35	C	M	0.56	72	42	33	28	21	16.6	13.9	11.1	8.3
	40	C	M	0.60	77	45	36	30	22	17.8	14.9	11.9	8.9
	50	C	M	0.67	86	50	40	33	25	19.9	16.6	13.3	9.9
	60	C	M	0.73	93	54	43	36	27	22	18.1	14.5	10.8
TP8008	30	C	C	0.69	88	51	41	34	26	20	17.1	13.7	10.2
	35	C	C	0.75	96	56	45	37	28	22	18.6	14.9	11.1
	40	C	C	0.80	102	59	48	40	30	24	19.8	15.8	11.9
	50	C	M	0.89	114	66	53	44	33	26	22	17.6	13.2
	60	C	M	0.98	125	73	58	49	36	29	24	19.4	14.6

There is more than one option to choose from, but this nozzle offers a broader range @ the speed he wishes to travel.

These calculations are based on a 20" spacing, refer to the Spray Products catalog for the formula for choosing a spacing other than 20".

V. SYSTEM PROGRAMMING

A. RAVEN CONSOLE (SPRAYER)

THIS IS JUST A GUIDE TO GET STARTED! REFER TO THE RAVEN INSTALLATION AND OPERATION MANUAL FOR MORE INFORMATION AND TROUBLE SHOOTING.

IMPORTANT:

Remember that the performance of the nozzle and the spray system is dependant on the performance of the operator. If the system is operated within the parameters of the nozzle type and the machine/console set up, you will see greater success with your application. Operating the machine even one or two miles per hour faster or slower than intended will greatly change the outcome of the programmed spray job.

NOTE: DATA MUST BE ENTERED INTO KEYS 3 THRU 7.

GETTING STARTED:

1. The entry sequence is always the same; 1) depress the key in which you wish to enter data, 2) depress the ENTER key (an E will illuminate in the screen), 3) depress the keys corresponding to the number you wish to enter (the numbers will be displayed as they are entered), 4) complete the entry by again pressing the ENTER key.
2. When the console is initially turned on, it will flash CAL and displayed ACRE US. This means that the console must be calibrated or programmed before it can be operated. Once the console is calibrated or programmed, you will not have to do it again unless you wish to make changes. All data is retained if the console is turned off.
3. If any error is made during the programming of the area measurement standard or the valve type, turn the console OFF. Depress CE and hold while turning the console power ON.

IMPORTANT! The information contained in this section is not meant to replace the information contained in the Raven's operational manual or the instructions of the chemical manufacturer. The information may need to be adjusted to suit the varying conditions under which the machine is being used. We can not account for the infinitely variable situations that may be unique to each machine, operator, and field/crop.

V. SYSTEM PROGRAMMING

A. RAVEN CONSOLE (SPRAYER)

THIS IS JUST A GUIDE TO GET STARTED! REFER TO THE RAVEN INSTALLATION AND OPERATION MANUAL FOR MORE INFORMATION AND TROUBLE SHOOTING.

Momentarily depressing the **CE** key is similar to using an arrow key to scroll through menu selections.

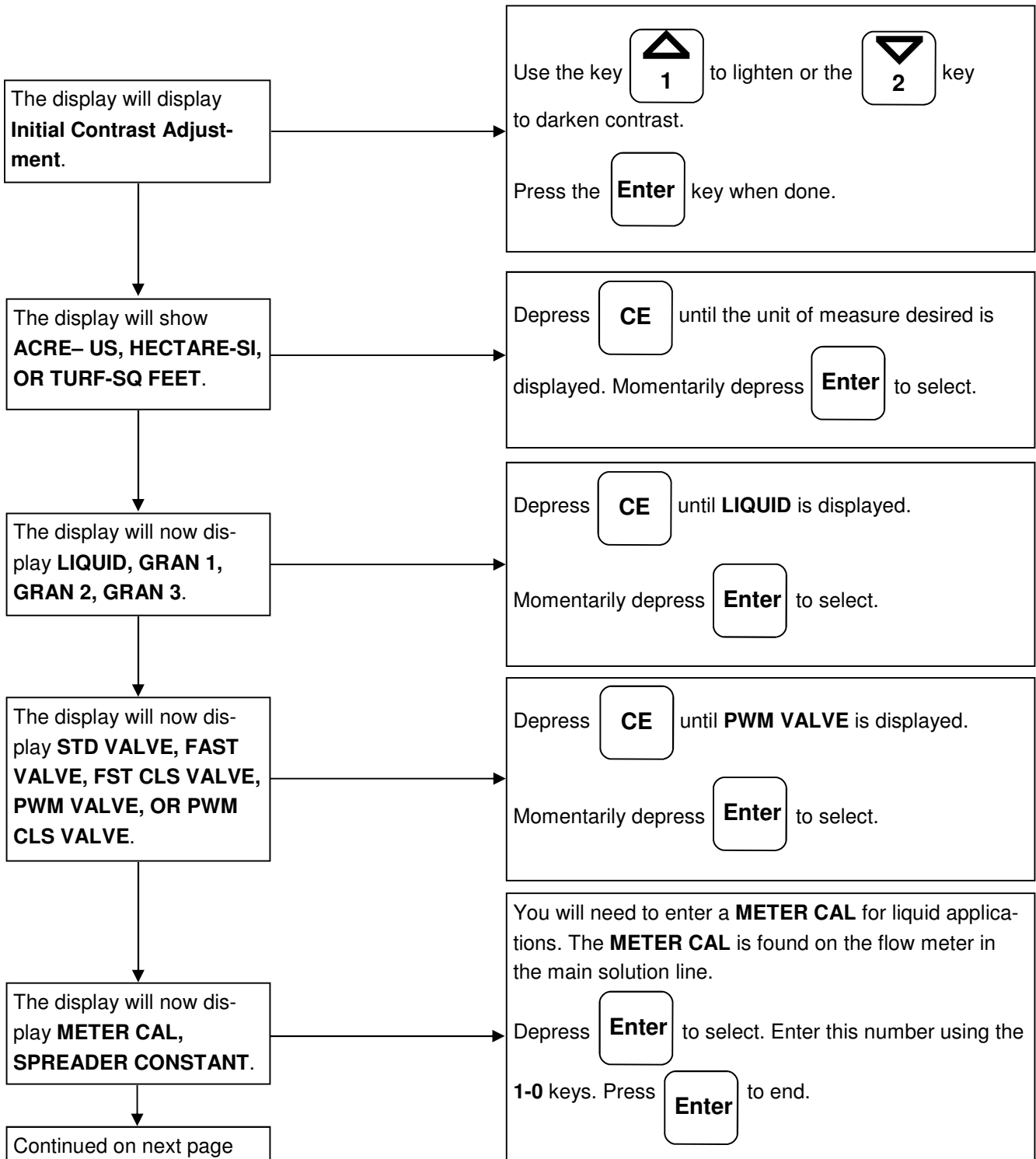

V. SYSTEM PROGRAMMING

A. RAVEN CONSOLE (SPRAYER)

THIS IS JUST A GUIDE TO GET STARTED! REFER TO THE RAVEN INSTALLATION AND OPERATION MANUAL FOR MORE INFORMATION AND TROUBLE SHOOTING.

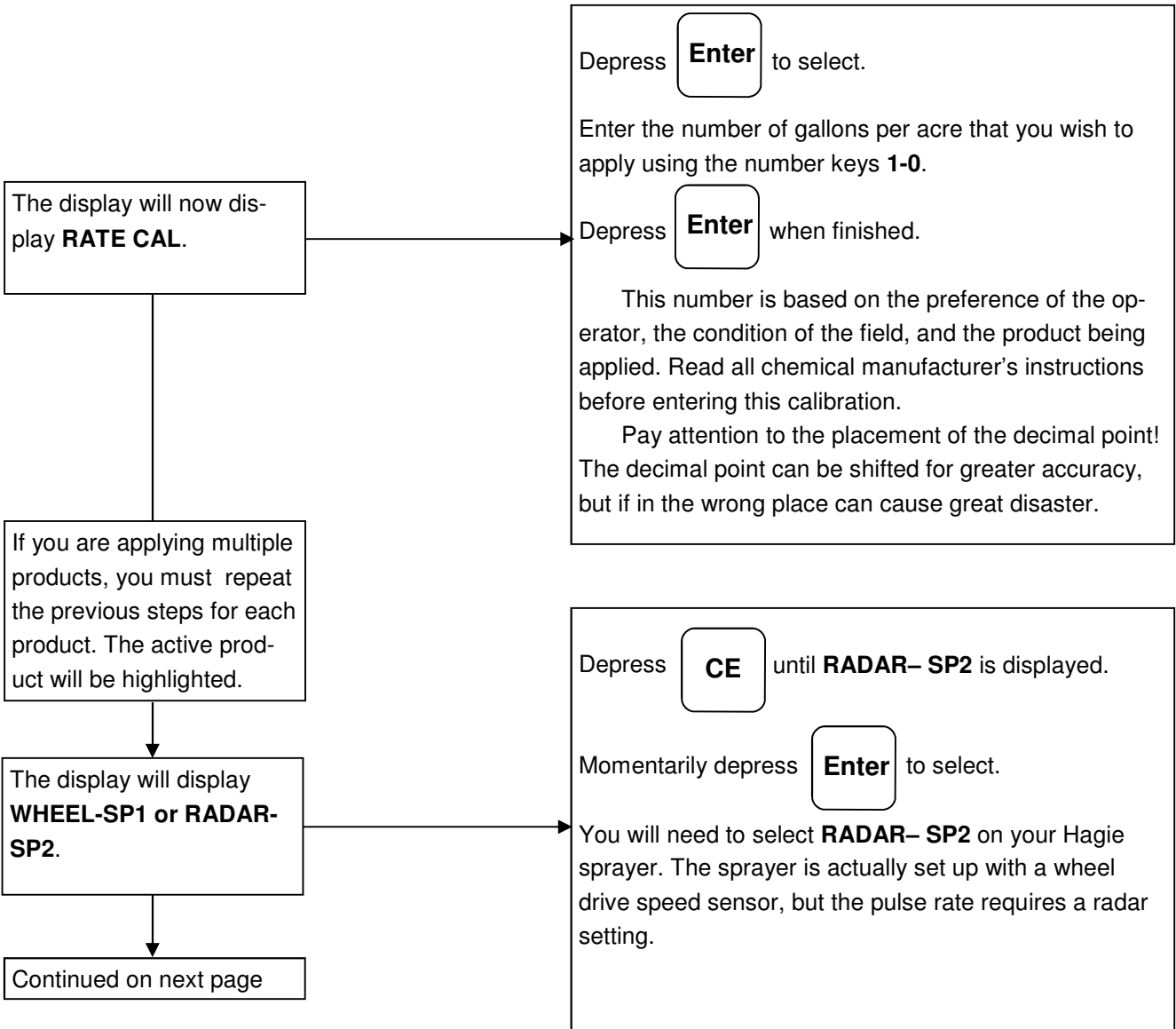

V. SYSTEM PROGRAMMING

A. RAVEN CONSOLE (SPRAYER)

THIS IS JUST A GUIDE TO GET STARTED! REFER TO THE RAVEN INSTALLATION AND OPERATION MANUAL FOR MORE INFORMATION AND TROUBLE SHOOTING.

The display will now display **SPEED CAL**.

The initial **SPEED CAL** is dependent on the size of tire installed on your machine. Below is a chart to get you started.

Depress **Enter** to select. Enter the number using the **1-0** keys.

The **SPEED CAL** may need to be refined after the initial programming of the console. Refer to the Raven manual for more information.

The speed that is displayed on the Raven console, if the console is programmed correctly and the **SPEED CAL** is refined as necessary, should closely match the speed displayed on the MDM.

Depress **Enter** when finished.

STS RAVEN CALS

	380/85R46	520/85R46	580/70R38	320/90R50	320/105R54	380/90R54
Bonfiglioli Hubs	356	399	356	360	399	398

*you must know the type of wheel hub on your machine to use these numbers. The serial number tag located on the wheel hub specifies which hub is on your machine.

Continued on next page

V. SYSTEM PROGRAMMING

A. RAVEN CONSOLE (SPRAYER)

THIS IS JUST A GUIDE TO GET STARTED! REFER TO THE RAVEN INSTALLATION AND OPERATION MANUAL FOR MORE INFORMATION AND TROUBLE SHOOTING.

Depress the **BOOM CAL 3** to enter the **BOOM CAL** number.

After depressing the **BOOM CAL 3** key, the **1** key and the **2** key will allow you to scroll through the different boom numbers.

To determine the **BOOM CAL** number, you will need to know how the boom is divided (the number of valves and what they control), the spacing option installed, and the number of nozzles per section.

The diagram below shows a dry boom option. (See the next page for a wet boom option diagram.)

The boom is numbered from left to right which is your "BOOM #" and corresponds with the **BOOM SPRAY SECTION** switches on the console.

To get the **BOOM CAL** number, multiply the number of nozzle tips by the spacing in inches.

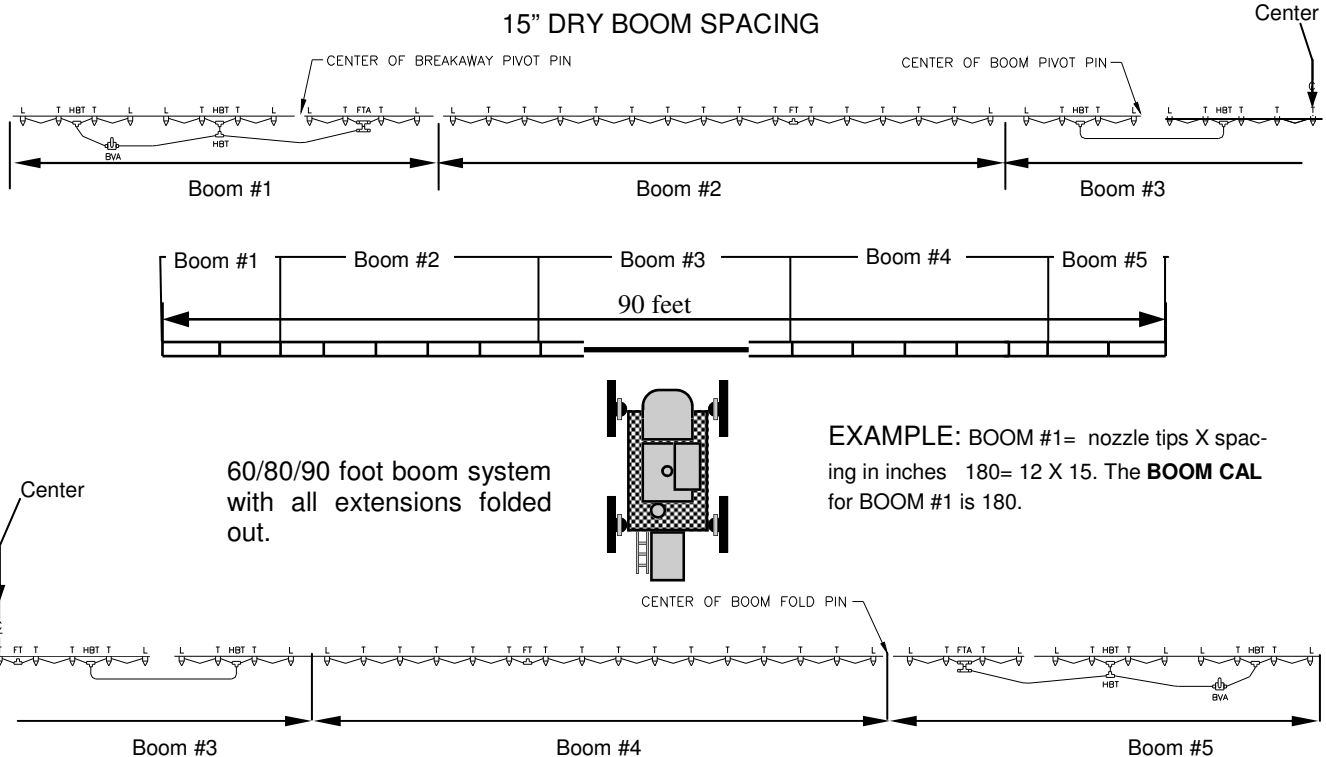

V. SYSTEM PROGRAMMING

A. RAVEN CONSOLE (SPRAYER)

THIS IS JUST A GETTING STARTED GUIDE! REFER TO THE RAVEN INSTALLATION AND OPERATION MANUAL FOR MORE INFORMATION AND TROUBLE SHOOTING.

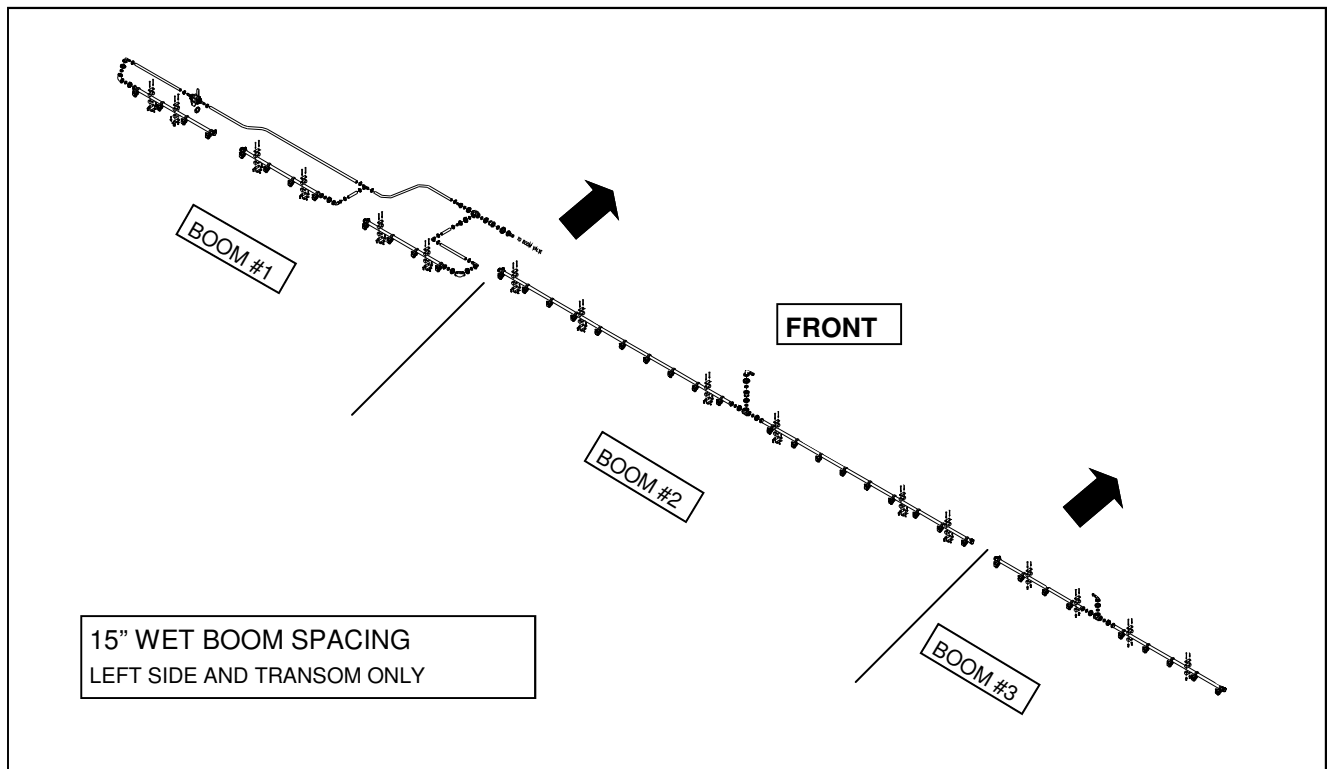
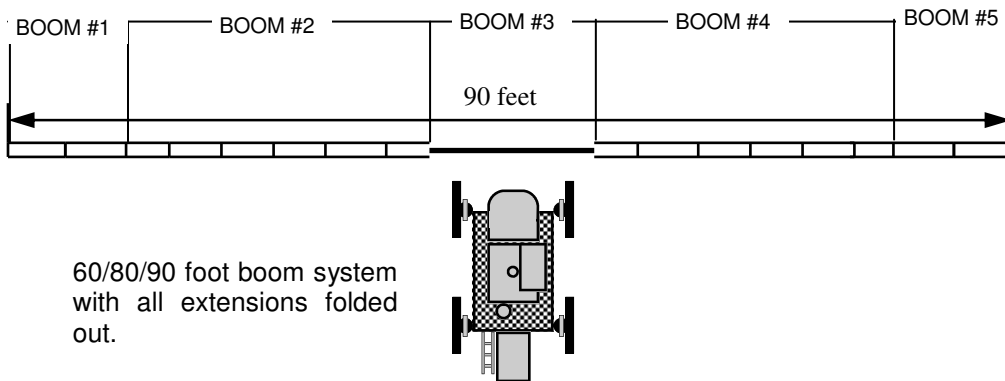

The difference between the dry boom (previous page) and the wet boom is that the dry boom's section 3 includes 4 nozzles on either side of the transom that are not included in the in the same section of a wet boom.

V. SYSTEM PROGRAMMING

A. RAVEN CONSOLE (SPRAYER)

THIS IS JUST A GETTING STARTED GUIDE! REFER TO THE RAVEN INSTALLATION AND OPERATION MANUAL FOR MORE INFORMATION AND TROUBLE SHOOTING.

To complete calibration you will need to enter some additional information.

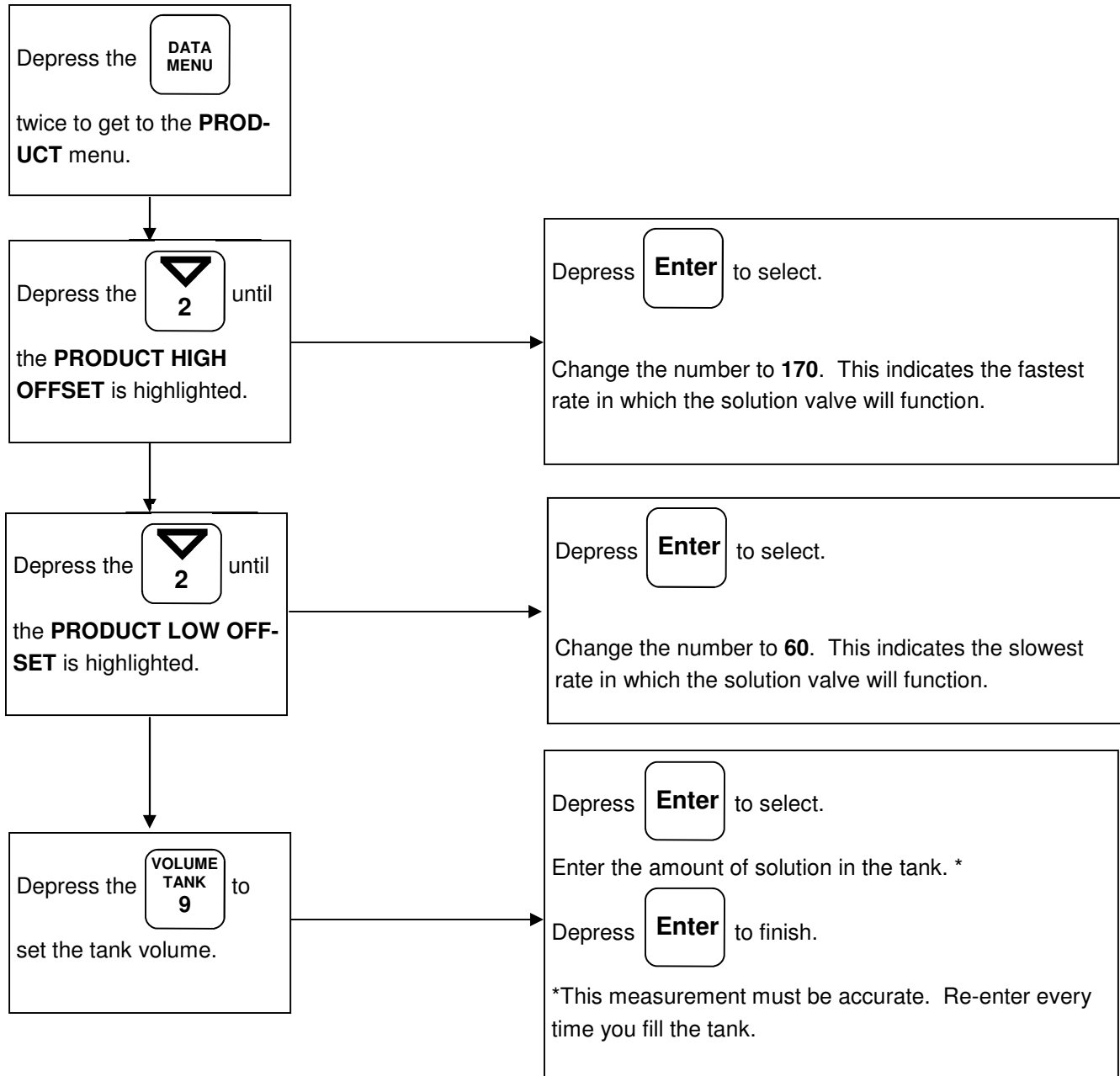

The initial programming is now complete. You may have to refine some of the numbers to better suit your unique situation. This is just a guide to get you started, these numbers may not be specific to your machine. We can not account for every individual situation.

V. SYSTEM PROGRAMMING

A. RAVEN CONSOLE (SPRAYER)

THIS IS JUST A GETTING STARTED GUIDE! REFER TO THE RAVEN INSTALLATION AND OPERATION MANUAL FOR MORE INFORMATION AND TROUBLE SHOOTING.



IMPORTANT:

DO NOT ADD CHEMICALS UNTIL CALIBRATION IS COMPLETED!

VERIFYING CALIBRATION

To test your system, fill the solution tanks with clean water. Do not add chemicals until calibration is completed!

With brakes applied, start the engine of the sprayer; throttle the engine to operating speed and remain parked. Turn on the Raven console. Turn on the work mode switch. Turn on the solution tank valve located on the right hand console. Turn on the main solution switch located on the hydrostatic lever. Turn on all boom section solution switches. Make sure there are no leaks and that all nozzles are spraying a desirable pattern. Continue spraying in the stationary position for at least 10 minutes for proper warm up of the sprayer and its system.

Once the system has had an adequate warm up period, you will need to perform a “self test” to simulate speed although the machine will remain stationary. (See the next page on quick instruction for performing a “self test”) Collect one nozzle’s spray for one minute in an adequately sized and marked container.

Verify that the collection equals or is close to the gallons per minute for the nozzle, pressure, speed, gallons per acre, and spacing that you are using.

V. SYSTEM PROGRAMMING

A. RAVEN CONSOLE (SPRAYER)

THIS IS JUST A GETTING STARTED GUIDE! REFER TO THE RAVEN INSTALLATION AND OPERATION MANUAL FOR MORE INFORMATION AND TROUBLE SHOOTING.

Performing a SELF TEST

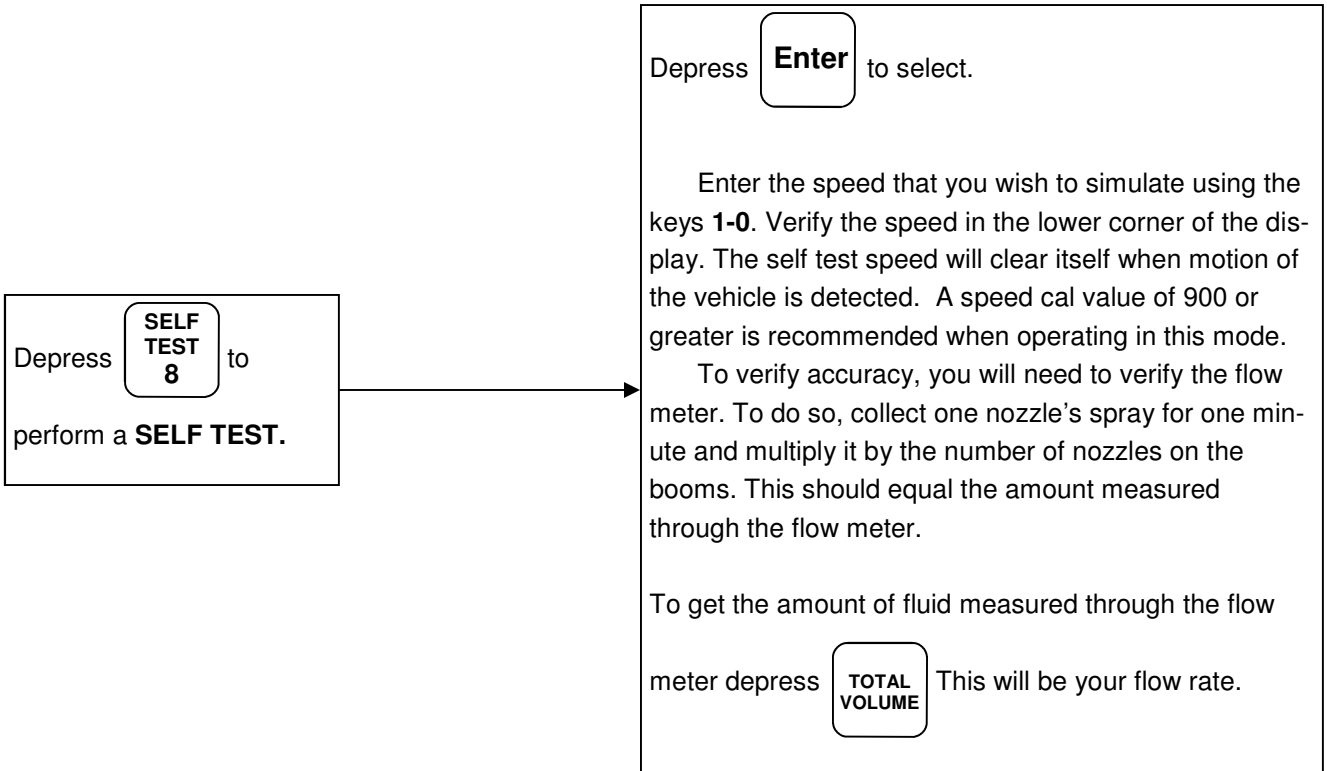

Changing VALVE CAL

*The **VALVE CAL** number is preprogrammed as 0043, but can be adjusted to suit your needs. Refer to the Raven manual for instructions.

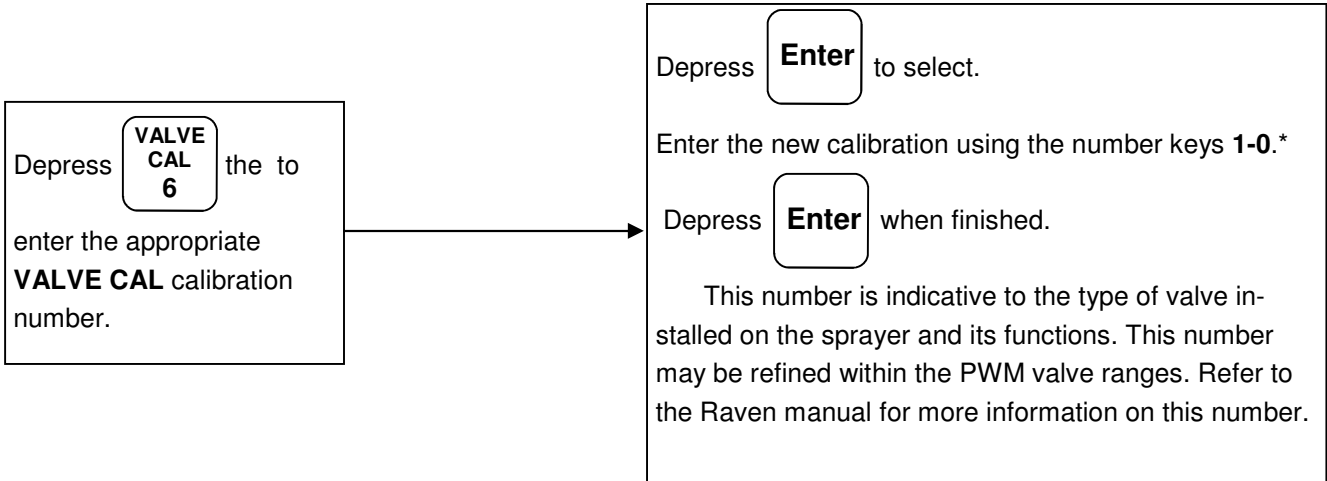

V. SYSTEM PROGRAMMING

SETTING UP THE HAGIE TASSELTRÖL®/LS SYSTEM 12™

Initial Set Up

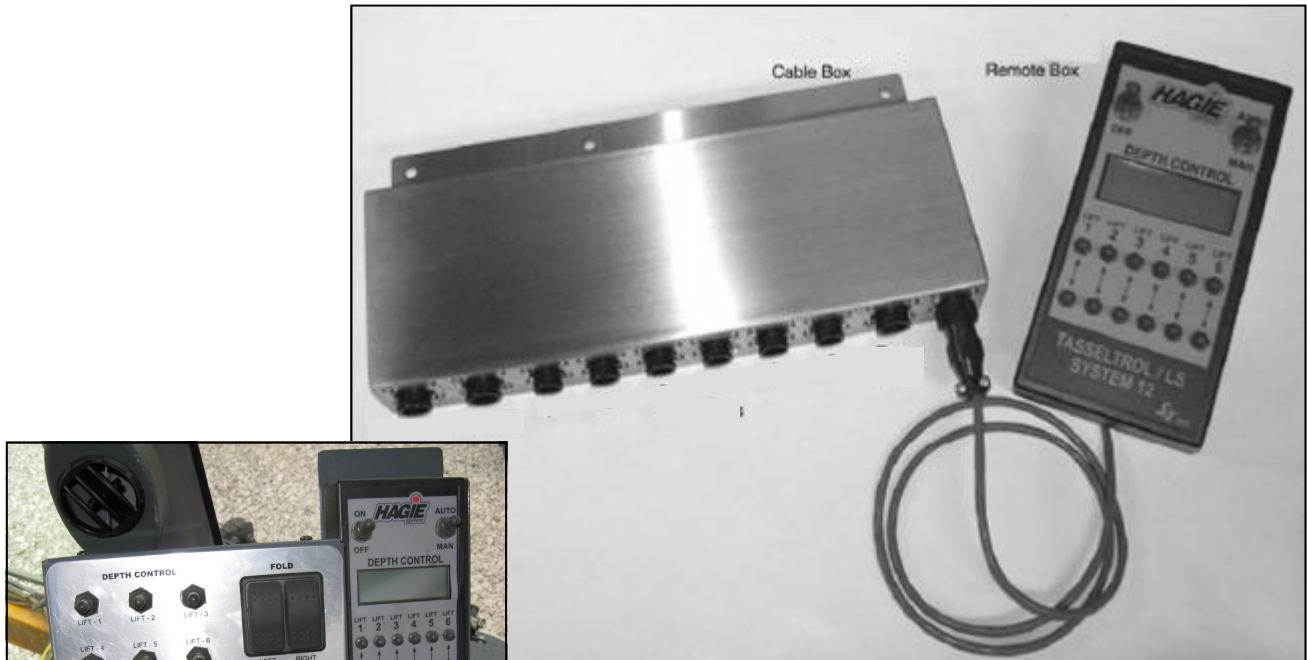

FIG. 91-1

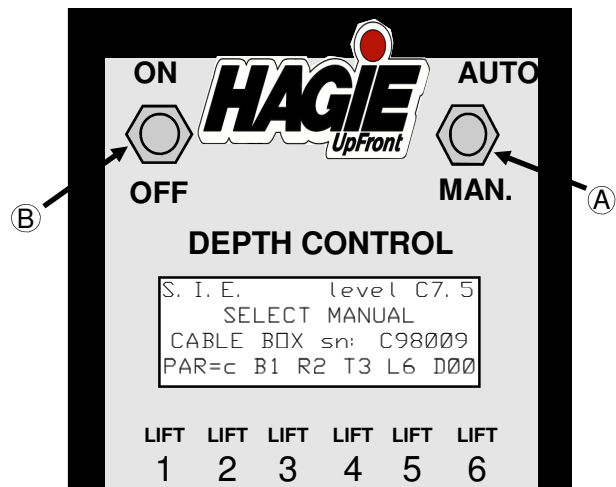

FIG 91-2

1. Enter the Parameter Mode:

Select **AUTO** by placing the **AUTO/ MAN.** switch (fig. 91-2, item 1) in the **AUTO** position. Now turn on the **DEPTH CONTROL** (fig. 91-1) by placing the **ON/OFF** switch (fig. 91-2, item 2) in the **ON** position.

In the LCD display window (fig. 91-3), there will be four lines. The top line displays the program level. The second line will flash **SELECT MANUAL** as a warning that you are about to enter the parameter adjusting mode.

The current parameter settings are displayed on the bottom line of the window. The values for **B, R,**

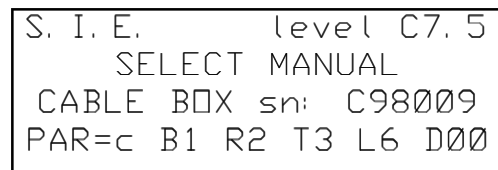

FIG. 91-3

***NOTE:** Machines with a Tasseltröl® software version level C8.7 and greater have an enhancement that allows the operator to set the lift speeds for the auto mode functions. (See instructions 5 and 7)

V. SYSTEM PROGRAMMING

HAGIE TASSELTRÖL® CONTINUED

T, and D are typically set as shown in figure 92-1.

The machine type will vary from **o**, **p**, or **c** depending on the valve system. Also, the **L** will vary depending on the number of lifts on the machine.

2. Match the machine valve type:

Press the **LIFT 1 up** button under the **PAR** on the LCD display window **two times** (fig. 92-1) and the display will show you the machine type that is selected (fig. 92-2). The “**o**”, “**p**”, or “**c**” just to the right of the **NEXT** on the bottom line of the LCD display indicates the type of machine. To change the type of machine, press the **LIFT 2 up** button that is located under this item. The display will now change to the **SELECT MACHINE TYPE** screen (fig. 92-3).

Select the type of machine that this unit is installed on. **For a machine prior to 2007, with the original valve system press the LIFT 4 button under “o”.** If the machine has the new proportional valves press the **LIFT 5** button under the “**p**”. If the machine is a 2007 or newer STS combination sprayer– detasseler with the proportional valves, press the **LIFT 6** button under the “**c**”.

The screen will now revert back to the **SELECT MANUAL** screen with the machine type that you have just selected displayed on the bottom line.

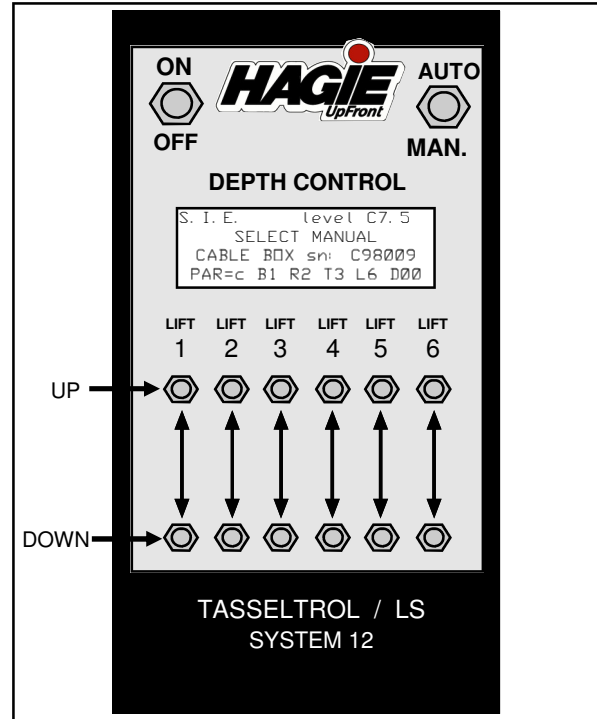

FIG 92-1

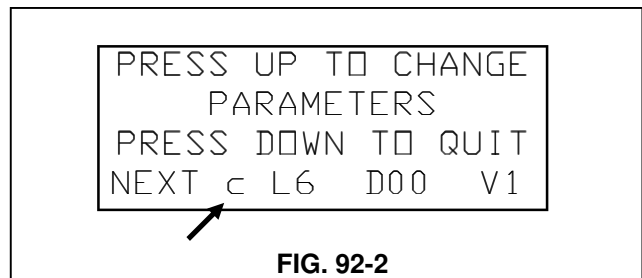

FIG. 92-2

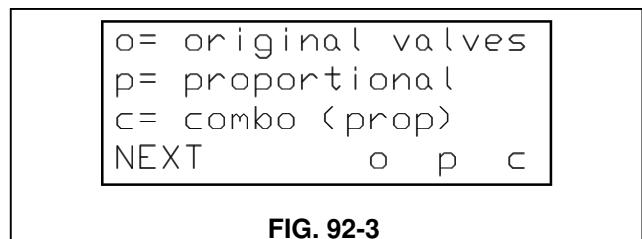

FIG. 92-3

V. SYSTEM PROGRAMMING

HAGIE TASSELTRÖL® CONTINUED

3. Match how many lifts are on the machine:

(If you are not in parameter mode, do Step 1 first and then do this step)

Press the **LIFT 1 up** button under the **PAR** on the LCD display **two times** and the display will show you how many lifts are turned on. In figure 93-1, item 1, the display shows **L6** indicating that all 6 lifts are on.

To change the number of lifts to match your machine, press the **LIFT 3 up** button under the **L** (fig. 93-1, item 1). This will display the **LIFTS: ON—OFF** screen (fig. 93-2).

Now press the **up** button under the lift that you want to turn on or off. In this example, lift 5 has been turned off. After selecting which lifts are to be on or off, press the **LIFT 1 down** button **two times** to exit this screen and save the new parameter setting.

4. Establish “D” and “V”:

(If you are not in parameter mode, do step 1 and then do this step)

Press the **LIFT 1 up** button under the **PAR** on the LCD display **two times** and the display will show the current setting of the **Dwell** (fig. 93-1, item 2) for all up and the **Valve compensation** (fig. 93-1, item 3) as either **1 = on**, or **0 = off**.

The **D** value indicates how many seconds that the lifts will travel up after the **ALL-UP** button (see page 56) on the hydrostatic handle is pressed momentarily. The time can be changed by pressing the **LIFT 4 up** button. It is normally set to **zero** before delivering the machine to the customer, but can be

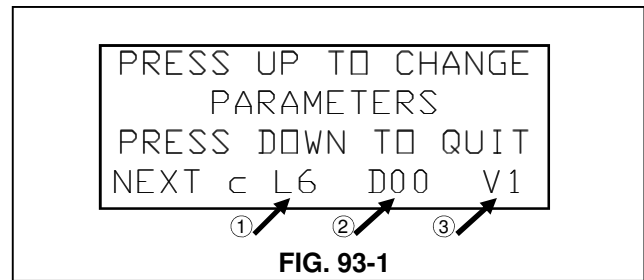

FIG. 93-1

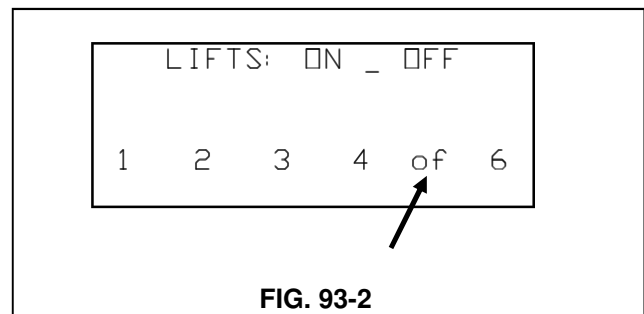

FIG. 93-2

set to a value of **20** while adjusting the machine valves. Pressing the **LIFT 4 up** button will add 5 seconds to the value each time until **D25** and then will return to **D00**.

When the value is set at **D00**, the up motion stops as soon as the hydrostatic handle **ALL-UP** button is released. If the value is set to anything greater than **D00**, the **ALL-UP** will only need to be pressed momentarily and the lifts will continue the up move until the parameter has been reached.

The **V** value indicates whether or not the valve automatic compensation is performed. Press the **LIFT 6 up** button to change this value. This is normally left at **V1**.

V. SYSTEM PROGRAMMING

HAGIE TASSELTRON[®] CONTINUED

5. Set the lift up speeds:

(if you are not in parameter mode, do step 1 first and then do this step)

Press the **LIFT 1 up** button under the **PAR** on the LCD display screen **three times** and the display will show the current setting of the up speed for an auto move*, a manual move and an all-up move with a value from **01** to **10**.

With the value set to **01**, the lifts will move very slowly. This setting of **01** is useful for adjusting the offset of the valves to get all the lifts to move at the same speed. Typically these values are set to **05** for a fairly fast speed. The values can be changed by pressing the up and down buttons under the **AUTO**, **MAN** or **ALL** (fig. 94-1).

The values can be saved by pressing the **LIFT 1 down** button to exit this screen and save the new parameter setting.

6. Set the lift up offset:

(if you are not in parameter mode, do step 1 first and then do this step)

Press the **LIFT 1 up** button under the **PAR** on the LCD display screen **four times** and the display will show the current setting of the **UP OFFSET** for the first three lifts (fig. 94-2). Pressing **NEXT** again will show the offset setting for the last three lifts. The **UP OFFSET** for each valve can be set from **-19** to **+20** as needed to get that lift speed to match the speed of the other lifts. The more positive the number, the faster the lift will move. Typically the offset is initially adjusted at a very slow speed by setting the **LIFT UP SPEED** to either **01** or **02**.

Exit the parameter mode and check the speed of

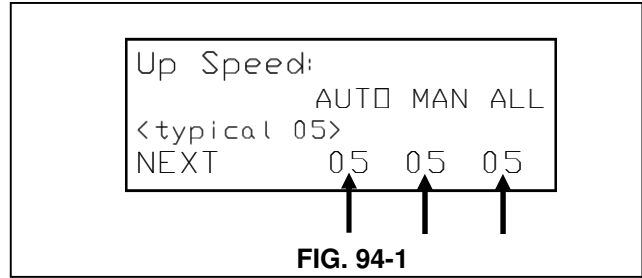

each lift by moving it manually with the up/ down buttons. Now correct the fastest and slowest lifts to match the average speed by changing the offset value with the up/down buttons for that lift while in the **LIFT UP OFFSET** parameter. When finished setting the offset values, return the speed setting back to about **05**.

Now with all the lifts at their lowest points, select **AUTO**. Now press the **ALL-UP** button on the hydrostatic handle so they will all move up at the same time. Correct the values for any lifts that are not close to the speed of the others.

The values can be saved by pressing the **LIFT 1 down** button to exit this screen and save the new parameter setting.

NOTE:
To get all the lift speeds even, you may need to lower the lift speed setting below 05. This will insure that the flow is being controlled by the valve rather than restricted by the .042" orifice. After adjusting the offset parameters for even up speeds, the up speed value can be increased back to 05.

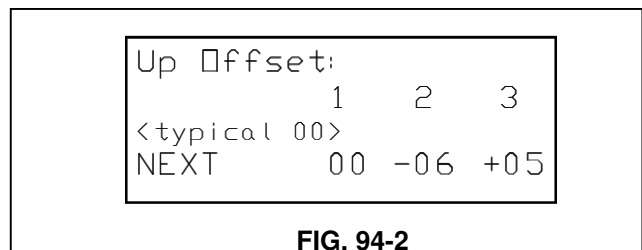

V. SYSTEM PROGRAMMING

HAGIE TASSELTRÖL® CONTINUED

7. Set the lift down speeds:

(If you are not in parameter mode, do step one first and then do this one)

Press the **LIFT 1 up** button under the **PAR** on the LCD display screen **six times** and the display will show the current setting of the down speed for an auto move*, a manual move and an all- resume move with a value of **01** to **10**.

With the value set to **03** the lifts will move a little slower. This setting of **03** is useful for adjusting the offset of the values for getting all the lifts the same speed. Typically these values are set to **05** for a fairly fast speed. The values can be changed by pressing the up and down buttons under the **AUTO**, **MAN** or **ALL** (fig. 95-1).

The values can be saved by pressing the **LIFT 1 down** button to exit this screen and save the new parameter setting.

8. Set the lift down offset:

(if you are not in parameter mode, do step 1 first and then do this one)

Press the **LIFT 1 up** button under the **PAR** on the LCD screen **seven times** and the display will show the current setting of the down offset for the first three lifts (fig. 95-2). Pressing **NEXT** again will show the offset setting for the last three lifts.

The down offset for each valve can be adjusted for a value from **-19** to **+20**. The more positive the number the faster the lift will move. Typically the offset is initially adjusted at a slightly slower speed by setting the lift down speed to **03**.

Exit the parameter mode and check the speed of each lift by moving it manually with the up/ down

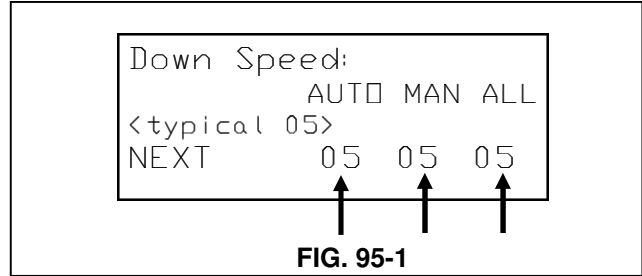

FIG. 95-1

buttons. Now correct the fastest and slowest lifts to match the average speed by changing the offset value with the up/down buttons for that lift while in the **DOWN OFFSET** parameter. When finished setting the offset values, return the speed setting back to about **05**.

Now with all the lifts at their highest points, select **AUTO** so all the lifts will move down together. Correct the values for any lifts that are not close to the speed of the others.

The values can be saved by pressing the **LIFT 1 down** button to exit this screen and save the new parameter setting.

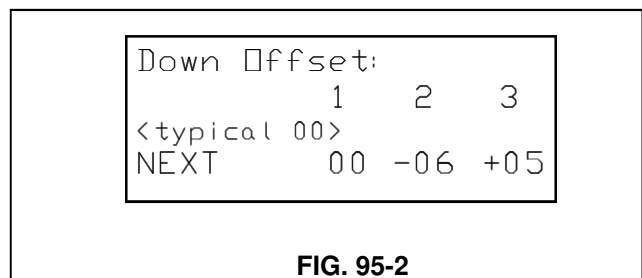

FIG. 95-2

NOTE:

Once the parameters have been set, very little adjustment will be required.

V. SYSTEM PROGRAMMING

HAGIE TASSELTROL® CONTINUED

SETTING UP THE HAGIE TASSELTROL®/LS SYSTEM 12™

LS System 12™ Parameters



FIG 96-1

Once you have set the operating parameters you can adjust the response parameters. These parameters are used to adjust the response of the controller and **SELDOM** need changing. The parameter values are stored in flash memory and will be retained even when no battery power is present. Your programmable control box is factory preset with the following parameter defaults:

BOTTOM PARAMETER – B1 See page 99 to reprogram the bottom parameter.

RESPONSE PARAMETER – R2 See page 97 to reprogram the response parameter.

TOP PARAMETER – T3 See page 98 to reprogram the top parameter.

These parameters will always be displayed until the control box is reprogrammed. Once reprogrammed, the new values for the parameters will appear in the window of the control box.

To program the unit, first select the response parameter (page 97). If further adjustment is required for top and/or bottom parameters, see pages 98 and 99.

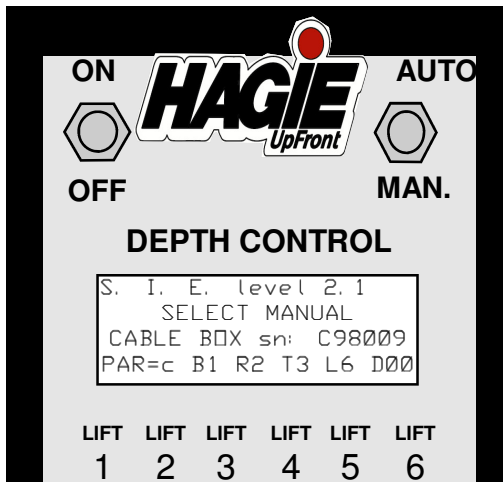

FIG 96-2

V. SYSTEM PROGRAMMING

HAGIE TASSELROL® CONTINUED

TASSELROL® RESPONSE PARAMETER

The response parameter is used to adjust the response time of both photocells. How quickly the down motion starts when no corn is detected by either the top or bottom cells, and how quickly the up motion is stopped when corn is no longer detected by the top cell, can be changed by selecting **R1**, **R2**, **R3**, or **R4**.

More corrections will occur with **R1** selected, and fewer corrections with **R4** selected. The normal or default value for this parameter is **R2**, but can be set to any desired value.

Use the response parameter to adjust overall correction activity and to compensate for ground speed. If the pullers are moving too quickly and frequently, the response parameter can be increased toward **R4**. If the pullers are too slow to respond to

changes in the corn depth, decrease the parameters toward **R1**. Generally this parameter can be left at **R2**.

To display the response parameter, select **AUTO** and turn the control box power on. Wait three seconds for the **SELECT MANUAL** message, press the **UP** button under **PAR**. Now press the **UP** button under the **R** value.

1. The active value of the parameter is indicated by it blinking on and off, while the other three choices are displayed continuously.
2. To select a new value for the parameter, press the **UP** button under the desired choice.
3. After selecting one of the four choices, press the **LIFT 1 down** button to escape this parameter.
4. To save new values and escape the parameter mode, press the **LIFT 1 down** button a second time.

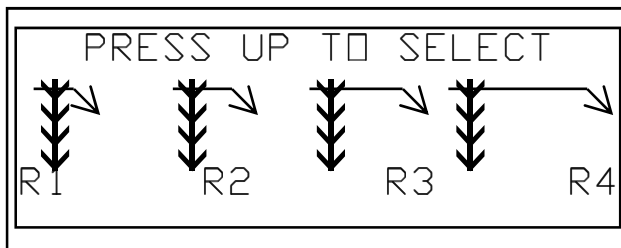
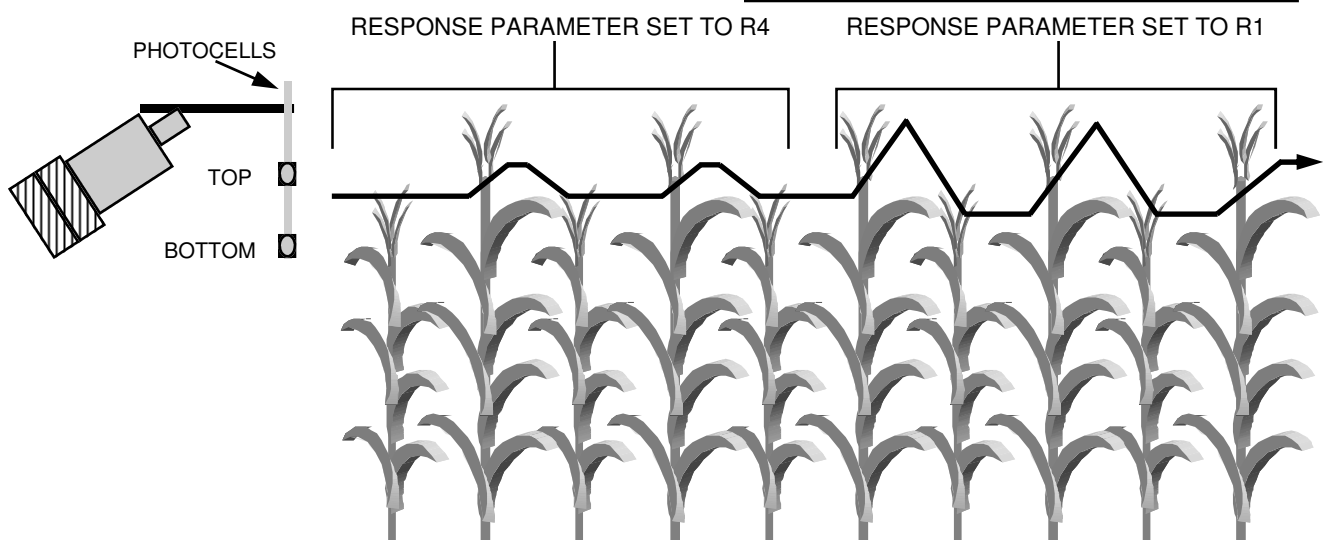

FIG 97-1

NOTE:

See page 78 for more information regarding the LS photo lights.



V. SYSTEM PROGRAMMING

HAGIE TASSELTRON[®] CONTINUED

TASSELTRON[®] TOP PARAMETER

The top parameter is used to adjust the sensitivity of the top photocell. The top photocell starts the up motion when its lights path is blocked by corn. How much corn it has to see before starting the up move can be changed by selecting one of the four values **T1**, **T2**, **T3**, or **T4**. With **T1** selected, less corn is required to start an up move. The normal or default value for this parameter is **T3**, but can be set to any desired value.

If the pullers move up too easily when a taller stalk of corn passes, increase the parameter toward **T4**. If the pullers stay deep too long when taller corn passes, decrease the parameter toward **T1**. Generally this parameter can be left at **T3**.

To display the top parameter, select **AUTO** and

turn the control box power on. Wait three seconds for the **SELECT MANUAL** message. Press the **UP** button under **PAR**. Now press the **UP** button under the **T** value.

1. The active value of the parameter is indicated by it blinking on and off, while the other three choices are displayed continuously.
2. To select a new value for the parameter, press the **UP** button under the desired choice.
3. After selecting one of the four choices, press the **LIFT 1 down** button to escape this parameter.
4. To save new values and escape the parameter mode, press the **LIFT 1 down** button a second time.

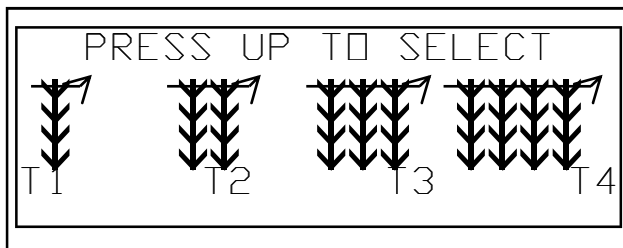
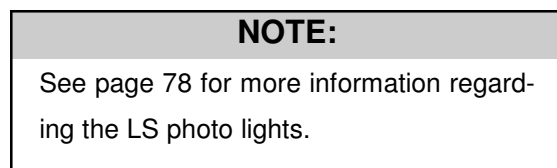
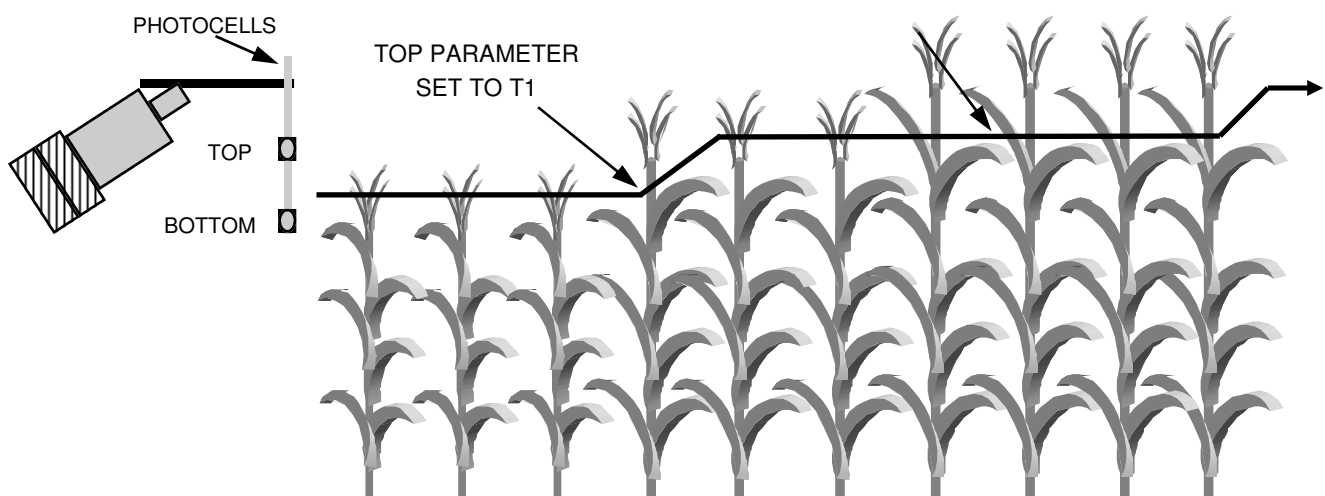

FIG 98-1



TOP PARAMETER SET TO T4



V. SYSTEM PROGRAMMING

HAGIE TASSELTROL® CONTINUED

TASSELTROL® BOTTOM PARAMETER

The bottom parameter is used to adjust the sensitivity of the bottom photocell. The bottom photocell stops the down motion when its light is blocked by corn. How much corn it has to see before stopping the down move can be changed by selecting one of the four values **B1**, **B2**, **B3**, or **B4**. With **B1** selected the down move will stop as soon as corn is detected. With **B4** selected the down move will continue a little longer. The normal or default value for this parameter is **B1**, but can be set to any desired value.

If the pullers run too shallow after moving down into shorter corn, increase the parameter toward **B4**. If the pullers move too deep when going into shorter corn or oscillate between the top and bot-

tom photocells, decrease the parameter toward **B1**. Generally this parameter can be left at **B1**.

To display the bottom parameter, select **AUTO** and turn the control box power on. Wait three seconds for the **SELECT MANUAL** message. Press the **UP** button under **PAR**. Now press the **UP** button under the **B** value.

1. The active value of the parameter is indicated by it blinking on and off, while the other three choices are displayed continuously.
2. To select a new value for the parameter, press the **UP** button under the desired choice.
3. After selecting one of the four choices, press the **LIFT 1 down** button to escape this parameter.
4. To save new values and escape the parameter mode, press the **LIFT 1 down** button a second time.

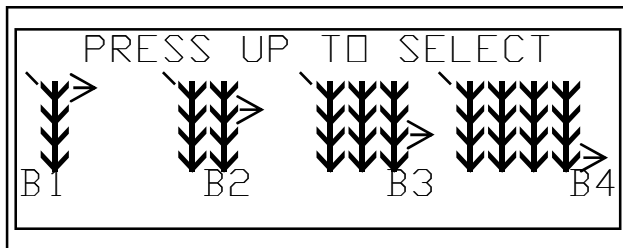
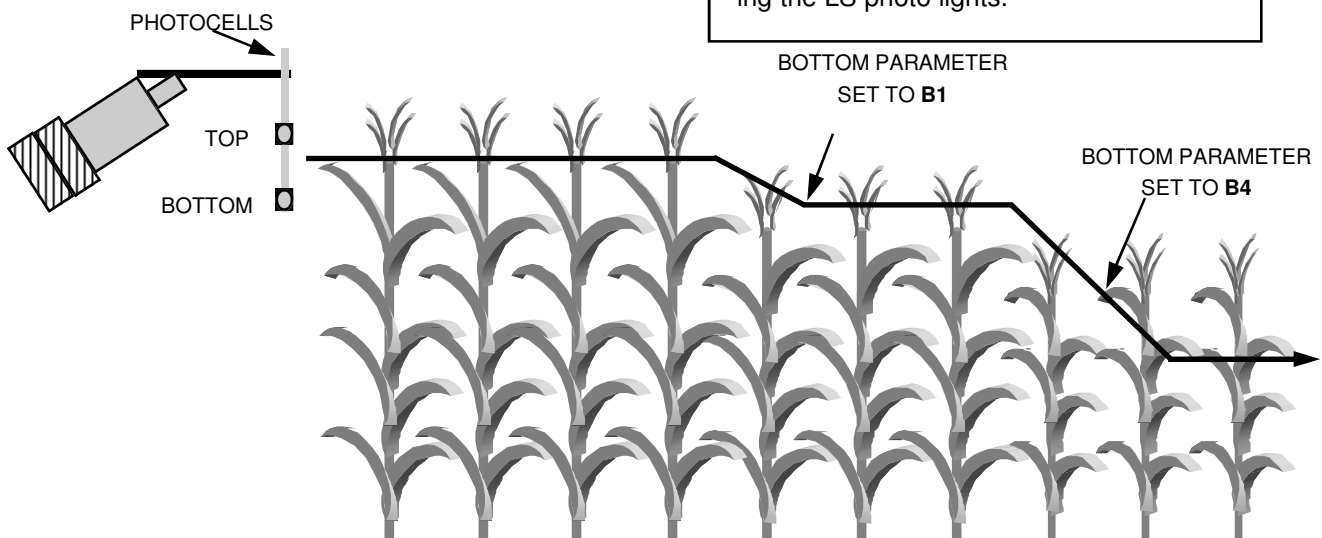

FIG 99-1

NOTE:
See page 78 for more information regarding the LS photo lights.



V. SYSTEM PROGRAMMING

B. HAGIE TASSELTROL®/LS SYSTEM 12™ (DETASSELER)



FIG 100-1

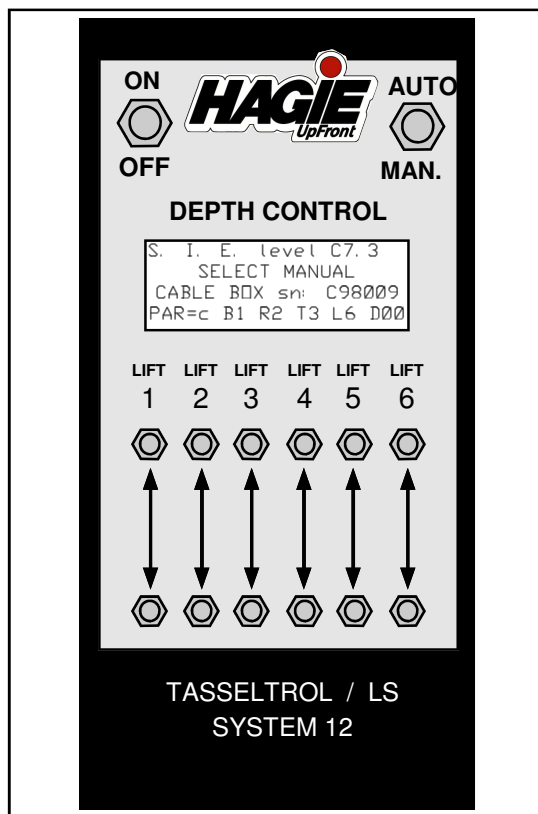

FIG 100-2

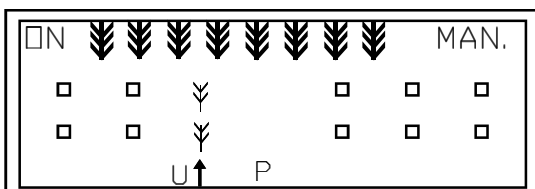

FIG 100-3

To use the control box with its normal parameter setting, use the following procedures. To adjust the given parameters, see pages 91-104.

1. From the operator's seat, turn the ignition to the **ON** position.
2. Turn the control box power switch to the **ON** position.
3. Turn the **AUTO/MANUAL** switch to **MANUAL**. At this time the display will read "MANUAL" in addition to other information identifying the control box.
4. Press the individual row switches for up and down movement. An arrow in the display will indicate direction of each lift assembly. **P** indicates pressure, **UP** only in "o" type machines, and **UP** and **DOWN** both in "p" and "c" type machines.
5. If the **AUTO/MANUAL** switch is left in the **AUTO** position when the unit is first started, the display will tell you to **SELECT MANUAL**. After you have selected **MANUAL** switch back to the **AUTO** position.
6. To override the system, press the desired **UP** switch to raise the attachment. When the switch is released, the system will go back into the **AUTO** mode.
7. If the ignition is left on and the **AUTO/MANUAL** switch is left in the **AUTO** position, the down coils on the electro-hydraulic valve will lose power after 45 seconds. To re-activate, move the **AUTO/MANUAL** switch from **AUTO** to **MANUAL** and back to **AUTO**.
8. The control box is set up with a feature so that if a unit loses contact during operation in the **AUTO** mode, the unit will automatically rise. If this should happen, switch to the **MANUAL** mode and determine the cause for malfunction.

V. SYSTEM PROGRAMMING

B. HAGIE TASSELTRÖL®/LS SYSTEM 12™ (DETASSELER)

SHORT CORN OPERATION-

When operating the LS system, always select **MANUAL** when first entering the field. Once you have maintained your operating speed and the cutting and/or pulling depth, select **AUTO**. When you come to an area where the corn is very short, such as a low spot in the field, you may want to switch to the **MANUAL** position until you reach taller corn.

Always switch to the **MANUAL** position before you reach the end rows (fig. 101-1). This will allow the cutter or puller heads to maintain their cutting or

pulling height when re-entering the field (fig. 101-1), then you may switch back to **AUTO**.

You may choose to use the **ALL UP/HOLD** function instead of switching to manual. This function will raise all the detasseling heads in one motion. For more information on the **ALL UP/HOLD** function refer to pages 103 and 102.

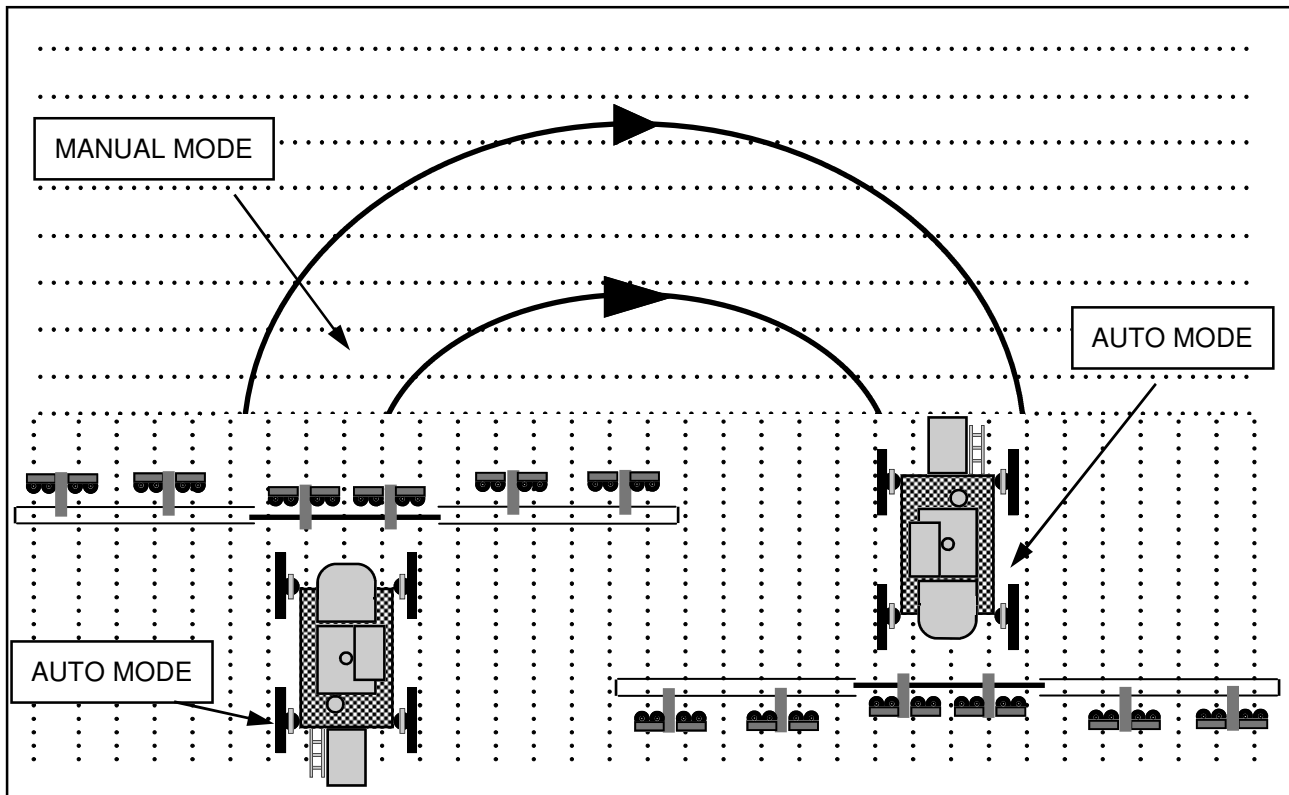

FIG 101-1

V. SYSTEM PROGRAMMING

B. HAGIE TASSELTROL®/LS SYSTEM 12™ (DETASSELER)

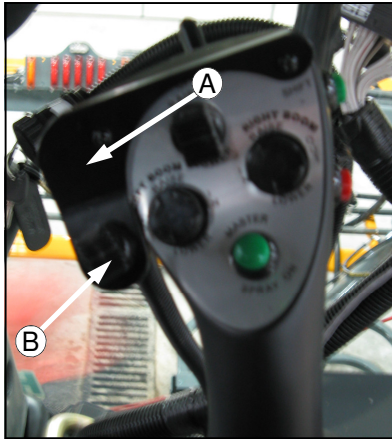

FIG 102-1

“ALL UP” and “ALL HOLD” Function-

This function can be used to raise or lower all row units at the same time. The switches to control this option are located on the hydrostat control handle (102-1) and the combo control panel (figure 102-2). All the row units will move up when the top of either switch (102-1, item A or 102-2, item A) is activated and will lower when the bottom of either switch (102-1, item B or 102-2, item B) is activated.

The parameters for dwell on the up move can be set to 0, 5, 10, 15, 20, or 25 seconds. The heads will move up this amount of time without having to hold the red switch in (only in values greater than 0). All heads will hold this position when the parameter is reached. To resume automatic depth control, activate the green switch.

To program the **ALL- UP** and **ALL- HOLD** functions see pages 93 and 94.

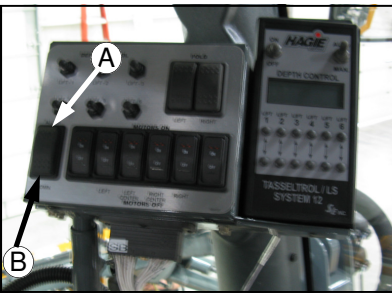

FIG 102-2

Additional Features-

To temporarily lock a lift up, hold the up button for that lift while switching from the manual to auto mode. The display will show an “L” for that lift to indicate that it is locked and will not move down automatically. The lift will return back to normal operation when the manual mode is again selected. (fig. 102-3, item A)

To display the supply voltage and current for the controller, press the **ALL-UP** button while in the manual mode. (fig. 102-3, item B)

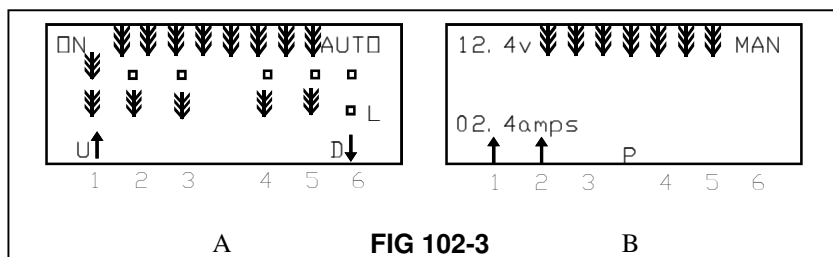

FIG 102-3

V. SYSTEM PROGRAMMING

HAGIE TASSELTROL® Display Screen Quick Reference Chart

Turn on the TASSELTROL® power switch with the "AUTO/ MANUAL" switch in "AUTO" position. This is how to enter the adjusting mode. Select MANUAL to save parameters and return to AUTO for automatic head adjustments.

Turn on the TASSELTROL® power switch with the "AUTO/ MANUAL" switch in "MAN" position.

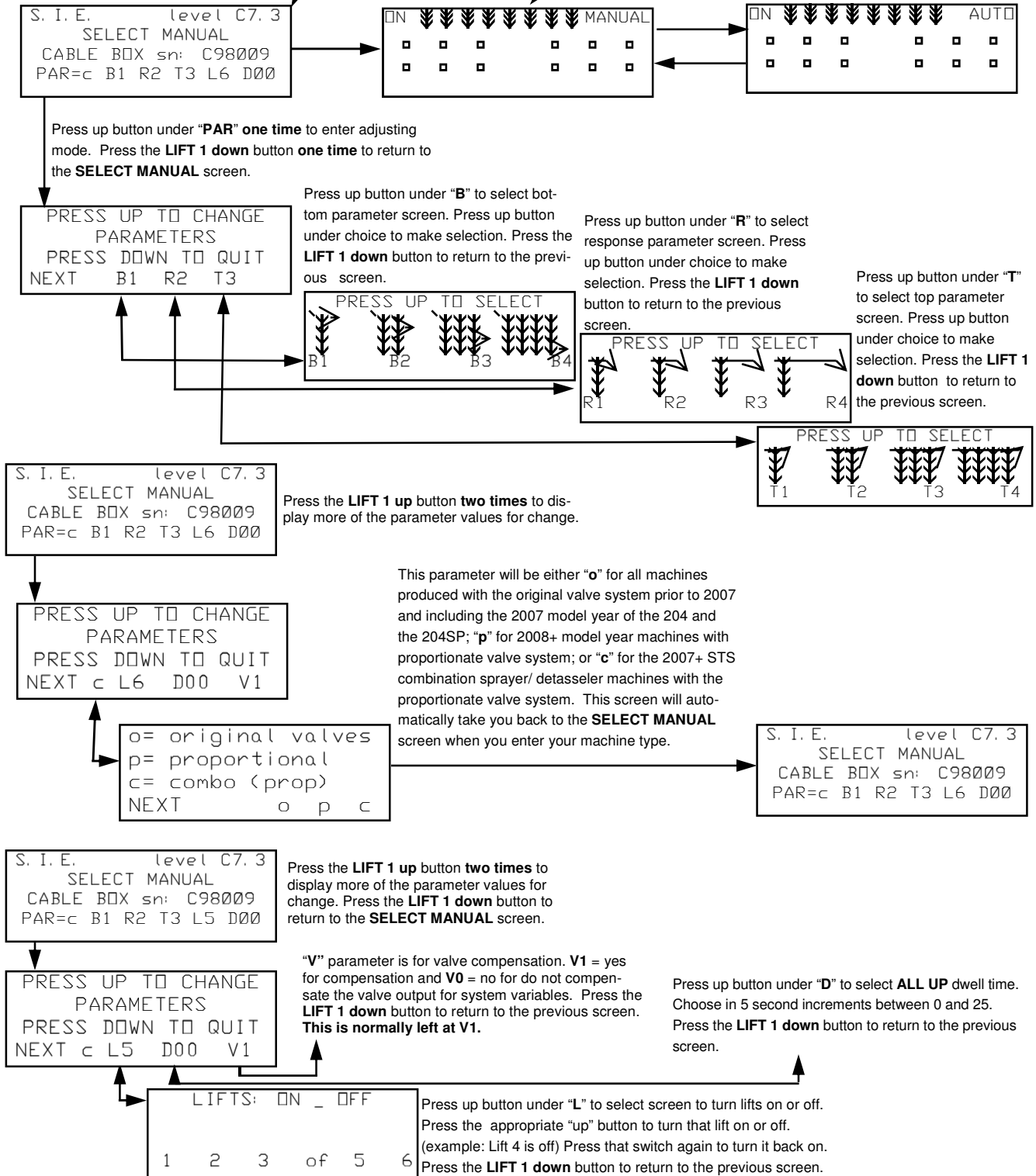

V. SYSTEM PROGRAMMING

HAGIE TASSELTRÖL® DISPLAY QUICK REFERENCE CHART CONTINUED

```
S. I. E.    level C7.3
SELECT MANUAL
CABLE BOX sn: C98009
PAR=c B1 R2 T3 L6 D00
```

Press the **LIFT 1 up** button **three times** to show the current setting of the up speed for auto*, manual and an all up move. Press the **LIFT 1 down** button to return to the **SELECT MANUAL** screen.

```
Up Speed:
          AUTO MAN ALL
<typical 05>
NEXT      05 05 05
```

```
S. I. E.    level C7.3
SELECT MANUAL
CABLE BOX sn: C98009
PAR=c B1 R2 T3 L6 D00
```

Press the **LIFT 1 up** button **four times** to show the current setting of the up offset for the first three lifts. Press the **LIFT 1 up** button to advance to the last three lifts.

```
Up Offset:
          1 2 3
<typical 00>
NEXT      +01 -06 00
```

Press the **LIFT 1 down** button to return to the **SELECT MANUAL** screen.

```
Up Offset:
          4 5 6
<typical 00>
NEXT      -07 +05 00
```

```
S. I. E.    level C7.3
SELECT MANUAL
CABLE BOX sn: C98009
PAR=c B1 R2 T3 L6 D00
```

Press the **LIFT 1 up** button **six times** to show the current setting of the down speed for auto*, manual and an all resume move. Press the **LIFT 1 down** button to return to the **SELECT MANUAL** screen.

```
Down Speed:
          AUTO MAN ALL
<typical 05>
NEXT      05 05 05
```

```
S. I. E.    level C7.3
SELECT MANUAL
CABLE BOX sn: C98009
PAR=c B1 R2 T3 L6 D00
```

Press the **LIFT 1 up** button **seven times** to show the current setting of the down offset for the first three lifts. Press the **LIFT 1 up** button to advance to the last three lifts.

```
Down Offset:
          1 2 3
<typical 00>
NEXT      +01 -06 00
```

Press the **LIFT 1 down** button to return to the **SELECT MANUAL** screen.

```
Down Offset:
          4 5 6
<typical 00>
NEXT      -07 +05 00
```

NOTE: With the exception of the machine valve type screen, which automatically reverts upon changing, you may advance through all the parameter settings while making changes without returning to the **SELECT MANUAL** screen each time by pressing the **LIFT 1 up** button instead of the down button. **LIFT 1 down** saves the changes upon exiting the parameter screen.

KEY

- = reflector with no corn present
- ☒ = the photo cell is blocked by corn
- ↓ = the down valve is on
- ↑ = the up valve is on

P = the pressure valve is on. Displayed in the lower middle part of the screen.

LV = the source of voltage fell below 10.8 vdc for a low voltage condition. Displayed in the upper left corner of the screen in place of "ON" when situation occurs.

SHORT = current exceeded 18 amps and outputs are turned off for a short time. Displayed in place of "ON" when situation occurs.

t = task not completed in the 30 seconds allowed, will resume on next task. Displayed in place of "ON" when situation occurs.

of = a lift is turned off by the parameter settings

L = the operator locked that lift up until manual is selected again. Displayed next to bottom photo cell icon for the valve that is locked.

ALL HOLD = the operator pressed the ALL-UP button on the hydrostatic handle. Displayed in the middle of the screen.

U, D, or B = either the up, down, or both manual buttons are pressed for that lift. Displayed next to the arrow for the lift being used.

VI. TRANSPORTING

A. CRADLING THE BOOMS

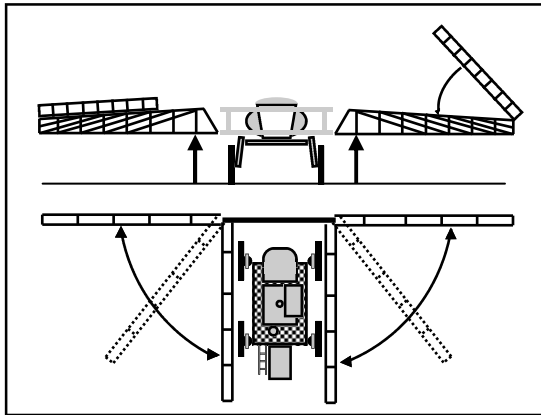

The booms should always be cradled before traveling, transporting, or parking for an extended period of time. **The booms must be folded when cradled.**

To cradle the booms, fold the boom extensions in, raise the transom, and fold the booms in toward the machine. When the boom reaches the last 8-10 degrees of travel, it will automatically slow down to avoid impact with the cradle. Raise each individual boom level until it clears the outer cradle stop (fig.

105-1). Fold the boom in toward the cradle back-stop. When it touches the back-stop, lower the boom level until the full weight of the boom rests in the cradle (fig. 105-2).

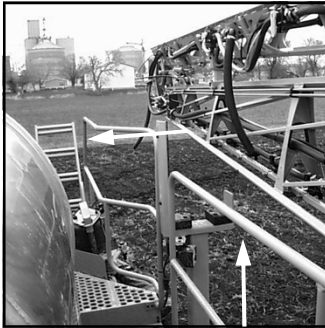
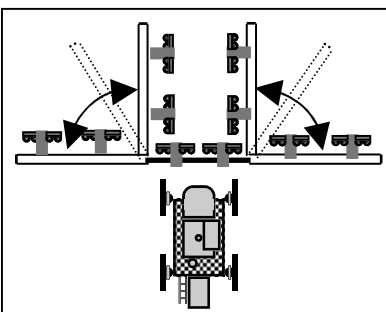

FIG 105-1



FIG 105-2

B. FOLDING THE OUTRIGGERS



Before folding the outriggers, the detasseling heads must be staggered in height. Damage will occur if the detasseling heads are all at the same height and the outriggers are folded!

To properly stagger the heads follow these steps: 1) raise the cutting or pulling depth all the way up using the depth command switches; 2) lower the center two heads all the way down; 3) raise all the heads on one side to approximately half the full raised height; 4) raise the heads on the opposite side to full raised height.

Slowly begin to fold the outriggers in, making adjustments as necessary to the height of the heads. Once the outriggers are folded completely, do not try to make adjustments to the heads as there is risk that you may entangle the stalk guides or depth command sensor bars causing damage.

VI. TRANSPORTING

B. DRIVING

WHEN DRIVING THE SPRAYER ON A PUBLIC ROAD OR HIGHWAY, DRIVE CAREFULLY AND FOLLOW THESE STEPS:

1. Always have the booms or outriggers in the folded position and the booms cradled when driving or transporting.
2. Flashing hazard/warning lights have been placed on the sprayer to warn other drivers.
3. Know and obey all state laws for driving farm equipment on a public road or highway.
4. Adjust the sprayer's speed to suit the conditions.
5. Slow down and use turn signals before turning.
6. Pull over to the side of the road before stopping.
7. Keep a proper lookout, and maintain control of the sprayer.
8. Do not drive under trees, bridges, wires, or other obstructions unless there is clearance.
9. Use extra care before entering or leaving a public road or highway.
10. A SMV (Slow Moving Vehicle) emblem has been mounted on the sprayer to warn other drivers that one is moving slowly. Keep it properly displayed, unless prohibited by law.
11. Do not drive sprayer at speeds exceeding 20mph with solution in the tank.



WARNING

DO NOT operate the machine at speeds exceeding 20mph with solution in the tank. Operating at speeds exceeding 20mph with a loaded tank may result in tire blow out or wheel hub damage and void the warranty.

NEVER operate machine on a public roadway with solution in the tank!



Hagie Manufacturing Company does not recommend any form of transportation other than driving the sprayer. Loading onto a trailer may result in sprayer tip-over.

VI. TRANSPORTING

C. TRAILERING

LOADING:



WARNING

Never load or unload a sprayer with solution in the tanks.



WARNING

Stopping the machine on the trailer ramps may result in sprayer tip-over!

When moving the machine onto a trailer, follow these steps completely:

1. Pull the trailer to flat ground. Apply the pulling vehicle's parking brake and turn off the engine. Use tire chocks to keep trailer from moving.
2. Fold in the sprayer's booms and lower to the boom cradle (fold in the outriggers).
3. Lower the trailer ramps and set the ramp spacing for the tread width setting.
4. Get someone to help guide you onto the trailer. Keep everyone a safe distance from the machine.
5. Allow enough room between the machine and the pulling vehicle for turning.
6. Secure the machine to the trailer. See the trailer's owner and operator manual for instructions.
7. Cover or remove the SMV (Slow Moving Vehicle) emblem when traveling over 25 miles per hour.

NOTE:

The loaded height and width of the trailer must conform to the law of the state in which it is being used.

NOTE:

Be sure to read and understand the trailer's owner and operator manual. Hitch the trailer to the pulling vehicle as shown in the trailer's owner and operator manual.



Hagie Manufacturing Company does not recommend any form of transportation other than driving the sprayer. Loading onto a trailer may result in sprayer tip-over.

VI. TRANSPORTING

C. TRAILERING

UNLOADING:



WARNING

Never load or unload a sprayer with solution in the tanks.



WARNING

Stopping the machine on the trailer ramps may result in sprayer tip-over.

When moving the machine off of a trailer, follow these steps completely:

1. Pull the trailer to flat ground. Apply the pulling vehicle's parking brake and turn off the engine.
Use tire chocks to keep the trailer from moving.
2. Lower the trailer ramps and set the ramp spacing to the machine's tread setting.
3. Release the securing restraints carefully.
4. Get someone to help guide you off the trailer. Keep everyone a safe distance from the machine.
5. Uncover or replace the SMV (Slow Moving Vehicle) emblem.

NOTE:

The loaded height and width of the trailer must conform to the law of the state in which it is being used.

NOTE:

The STS 14 Combo should never be towed under any circumstances.* Machine damage will occur and void the power train warranty.



* Contact Hagie Customer Support if towing is necessary.

VII. SERVICE AND MAINTENANCE

A. SERVICE POINT QUICK REFERENCE CHART

PAGE #	SERVICE POINT	CLEAN	CHANGE	CHECK	GREASE	DRAIN
114	ENGINE OIL		500HRS	DAILY		
120	ENGINE LUBE FILTER		500HRS			
116	RADIATOR COOLANT		1000HRS	DAILY		
116	COOLANT CONCENTRATION		AS REQ	500HRS		
119	RADIATOR GRILLE SCREEN	AS REQ		DAILY		
126	ENGINE DRIVE BELT		AS REQ	DAILY		
126	A/C COMPRESSOR BELT		AS REQ	250HRS		
115	A/C COMPRESSOR		B			
120	FUEL FILTER (WATER SEPARATOR)		500HRS*			DAILY
120	REMOTE FUEL FILTER		500HRS*			
120	IN-LINE FUEL STRAINER		500HRS*			
118	AIR INTAKE FILTER	H	C			
118	FILTER MINDER®		D	DAILY		
114	HYDRAULIC RESERVOIR OIL LEVEL		500HRS	DAILY		
119	HYDRAULIC RETURN/SUCTION FILTER		E*			
119	HYDRAULIC SUCTION STRAINER	500HRS				
121	SOLUTION LINE STRAINER	AS REQ		DAILY		
115	WHEEL HUB OIL LEVEL		F*	100HRS		
131	WET TANK/AIR TANK					A
131	AIR DRYER CARTRIDGE		1000HRS	50HRS		
122	FRONT LEG STRG ZERKS (2- 1EA LEG)				50HRS	
122,123	ALL OTHER GREASE ZERKS				50HRS	
128	TREAD ADJUSTMENT BEARING TORQUE		AS REQ	I		
124	BATTERIES	100HRS	AS REQ	DAILY		
127	LUG NUT TORQUE			G		
131	TIRE PRESSURE			50HRS		
121	FRESH AIR (PAPER) CAB FILTER	50HRS	AS REQ			
121	CHARCOAL CAB FILTER		AS REQ			
132	SPRAY NOZZLE DIAPHRAGMS & TIPS		1000HRS	500HRS*		
131	AIRBAGS (VISUALLY)			50HRS		
75	QUAD PULLER PSI (4 PLACES EACH ROW)			DAILY		
123	QUAD PULLER BEARINGS (4 PLACES EACH ROW)				2X DAILY	
76	CUTTER BLADE RETAINING BOLT (TIGHTEN)			DAILY		
125	FUSES AND CIRCUIT BREAKERS		AS REQ			
	ENGINE EXHAUST BREAK			J		

VII. SERVICE AND MAINTENANCE

A. SERVICE POINT QUICK REFERENCE CHART

NOTES

- *AT THE BEGINNING OF THE SEASON (YEARLY) OR AS REQUIRED, WHICHEVER COMES FIRST
- **NOTE A:** CHECK FOR EXCESSIVE MOISTURE
- **NOTE B:** CHARGE AS REQ; USE PROPER EQUIPMENT
- **NOTE C:** FOLLOW FILTER MINDER READINGS
- **NOTE D:** RESET EACH TIME YOU SERVICE AIR FILTER
- **NOTE E:** 1ST 50HRS, THEN 250HRS THEREAFTER
- **NOTE F:** 1ST 50HRS, THEN YEARLY
- **NOTE G:** IMMEDIATELY, THEN 50HRS THEREAFTER
- **NOTE H:** NOT RECOMMENDED
- **NOTE I:** VISUALLY CHECK THE BOLTS EVERY 50 HOURS, TORQUE CHECK THEM EVERY 100 HOURS
- **NOTE J:** CHECK EVERY 1000HRS.; CALL CUMMINS CUSTOMER SERVICE FOR REPAIR AND REPLACEMENT

SERVICE INTERVALS

Initial checks after receiving machine

IMMEDIATELY  then 

- 1) Check lug nut torque, then every 50 hours (page 127)

FIRST 50 HOURS  then 

- 1) Change wheel hub oil, again at 100 hours, and then every 500 hours thereafter (page 115)
- 2) Change hydraulic return/suction filter, then every 250 hours thereafter (page 119)

Daily

- 1) Check engine oil (page 114)
- 2) Check and drain fuel filter (water separator) (page 120)
- 3) Check radiator coolant level (page 116)
- 4) Check engine drive belt (page 126)
- 5) Check Filter Minder® (page 118)
- 6) Check hydraulic oil reservoir level (page 114)
- 7) Check solution line strainer (page 120)
- 8) Drain wet tank and air tank (page 131)
- 9) Check batteries (page 124)
- 10) Check radiator grille screen (119)
- 11) Check quad puller tire pressure (page 75)
- 12) Grease quad puller bearings twice daily (page 123)
- 13) Tighten cutter blade retaining bolt (page 76)

VII. SERVICE AND MAINTENANCE

A. SERVICE POINT QUICK REFERENCE CHART

As Required



- 1) Change coolant concentration (page 116)
- 2) Clean radiator grille screen (page 119)
- 3) Change engine drive belt (page 126)
- 4) Change A/C compressor belt (page 126)
- 5) Charge A/C compressor (page 115)
- 6) Change fuel filter (water separator) (page 120)
- 7) Change in-line fuel strainer and remote fuel filter (page 120)
- 8) Clean solution line strainer (page 121)
- 9) Change batteries (page 124)
- 10) Change paper cab filter (page 121)
- 11) Change charcoal cab filter (page 121)
- 12) Check and replace spray nozzle diaphragms and spray tip (page 132)
- 13) Change fuses and circuit breakers (page 125)

Every 50 HOURS



- 1) Check tire pressure (page 131)
- 2) Check lug nut torque (page 127)
- 3) Visually inspect tread adjust bearing bolts (page 128)
- 4) Grease all lubrication zerks (page 122, 123)
- 5) Knock particles from fresh air intake cab filter (page 121)
- 6) Check air dryer cartridge (page 131)

Every 100 HOURS



- 1) Check wheel hub oil level (page 115)
- 2) Clean batteries (page 124)
- 3) Check tread adjust bearing bolt torque (page 128)

VII. SERVICE AND MAINTENANCE

A. SERVICE POINT QUICK REFERENCE CHART

Every 250 HOURS

- 1) Check A/C compressor belt (page 126)
- 2) Change hydrostatic charge pressure and suction filter (page 119)

Every 500 HOURS or

- 1) Check coolant concentration (page 116)
- 2) Change fuel filter (water separator) (page 120)
- 3) Change hydraulic reservoir oil (page 114)
- 4) Change wheel hub oil (page 115)
- 5) Check spray nozzle diaphragms and spray tips (page 132)
- 6) Change engine oil (page 114) and lube filter (120)
- 7) Change the in-line fuel strainer (page 120)
- 8) Change the remote fuel filter (page 120)

Every 1000 HOURS or

- 1) Change radiator coolant (page 116)
- 2) Change air dryer cartridge (page 131)
- 3) Change spray nozzles and tips (page 132)
- 4) Check engine exhaust break. Call Cummins for servicing.

VII. SERVICE AND MAINTENANCE

A. SERVICE POINT QUICK REFERENCE CHART

DAILY INSPECTION

Inspection Point	Action (if necessary)
Check	
Engine oil level	Add oil
Radiator coolant level.....	Add antifreeze solution
Engine drive belt.....	Replace belt
Filter Minder®	Replace air filter element/ reset gauge
Hydraulic reservoir oil level.....	Add hydraulic oil
Solution line strainer.....	Remove and clean
Batteries	Clean and/or tighten
Radiator grille screen	Clean
Look for loose or missing items such as shields.....	Tighten or replace
Look for any fluid leaks pooled on machine or ground	Determine cause and correct
Quad puller tire pressure	Add air if necessary
Quad puller bearings	Grease twice daily
Cutter blade retaining bolt	Tighten as needed
Drain	
Fuel/water separator	See page 120
Wet tank/air tank	See page 131

VII. SERVICE AND MAINTENANCE

B. FLUIDS

ENGINE OIL

OIL LEVEL—The engine oil level dipstick is located on the left-hand side of the engine (fig. 114-1). Never operate the engine with the oil level below the “L” (low) mark or above the “H” (high) mark. Wait at least five minutes after shutting off the engine to check the oil level, this allows the oil to drain to the oil pan. Check the engine oil level daily.

CAPACITY— Low to high mark capacity is 2.0 quarts. Engine oil pan capacity is 18.5 quarts. Change every 500 hours. Refill with 15W40 diesel engine oil.



FIG 114-1

NOTE:

The engine must be level when checking the oil level to make sure the measurement is correct.

HYDRAULIC OIL RESERVOIR

OIL LEVEL— Check the sight gauge level on the hydraulic oil reservoir (fig. 114-2) daily. Add just enough fluid so the level is in the center of the sight gauge. Always check the hydraulic oil level when it is cool. Hydraulic oil will expand when heated.

TYPE— Premium hydraulic fluids containing high quality rust/oxidation/ and foam inhibitors are required. Hydraulic oil must conform to one of the following types: anti-wear hydraulic oil, type F automatic transmission fluid, or agricultural hydraulic transmission fluid. Replace the oil in the hydraulic reservoir at 500 hours or at the beginning of each spraying season, whichever comes first.



FIG 114-2

NOTE:

CLEANLINESS STANDARD: Always make sure area is clean before changing filter or hydraulic oil.

VII. SERVICE AND MAINTENANCE

B. FLUIDS

WHEEL HUB OIL

BONFIGLIOLI

OIL LEVEL— Each wheel hub should maintain a proper oil level at all times. Less than that would limit lubrication and over full would cause overheating and damage. To check the oil level, position the hub so one of the face plugs is positioned at 12 O'clock (fig. 115-1, item A). The other plug will be either at 8 O'clock (fig. 115-1, item B). (When positioned correctly the arrows in the center of the hub should make an "L".) Remove the lower plug; if no oil comes out, the oil level is too low. Check wheel hub oil level every 100 hours.

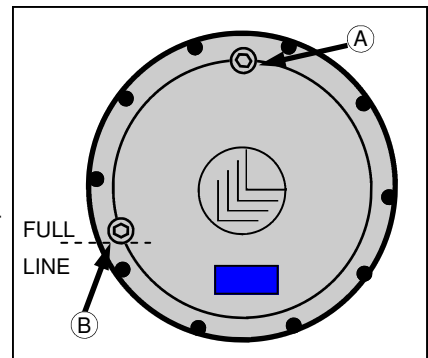

FIG 115-1

If SAE 80W/90 or SAE 85W/140 with EP features oil is needed, remove the top plug also and fill just until it starts to come out the lower hole (approximately 40 ounces). With the oil at a satisfactory level, re-install plugs.

CHANGE— The wheel hub oil should be changed after the first 50 hours of field operation. Subsequently, it should be changed every 500 hours or yearly (whichever comes first).

To change the wheel hub oil, position the plugs so that one is at the 6 O'clock position, and the other is between the 2 and 3 O'clock positions. Remove the bottom plug to drain the oil. Once all of the oil is drained, rotate the hub so that the plugs are in the filling position (fig. 115-1). Refill wheel hub with gear oil as described above.

GENERAL MAINTENANCE- If your sprayer is going to sit for an extended period of time, occasionally rotate the hubs by driving the sprayer forward and backward at least 1/2 of a tire rotation to adequately coat all internal hub parts. This will prevent rusting if moisture inadvertently entered the hub during an oil change. Failure to rotate the hub and disperse oil may cause rusting and internal damage to the hub.

VII. SERVICE AND MAINTENANCE

B. FLUIDS

COOLING SYSTEM

COOLANT TYPE– Your cooling system should always be sufficiently charged with an adequate mixture of antifreeze and water, regardless of the climate, in order to maintain a broad operating temperature range. Your cooling system has been factory charged with an ethylene-glycol based antifreeze.



FIG 116-1

CHECKING CONCENTRATION– The radiator cap is located toward the rear of the engine compartment (fig. 116-1). Never remove the cap from a hot engine. Always allow the engine to cool before servicing the cooling system.

A 50/50 antifreeze/water mixture is a conservative mixture which allows good protection against both overheating and freezing. If a stronger antifreeze mixture is required, be sure not to exceed the engine manufacturer's guidelines for antifreeze mixing. The table in figure 116-2 gives a few examples of ethylene-glycol antifreeze/water mixture protection values. Consult the engine manufacturer's handbook for further information.

Ethylene Glycol		
40%	-23°C	-10°F
50%	-37°C	-34°F
60%	-54°C	-65°F

FIG 116-2

Concentration should be checked every 500 hours or at the beginning of each winter, whichever comes first. A refractometer should be used to check concentration, "floating ball" type density testers are not accurate enough for use with heavy duty diesel cooling systems.

CHANGING COOLANT– Your coolant should periodically be changed to eliminate the buildup of harmful chemicals. Drain and replace the coolant every other spraying season or 1,000 hours of service, whichever comes first. Refill only with soft water because hard water contains minerals which break down the anti-corrosion properties of antifreeze.

WINDSHIELD WASHER FLUID

RESERVOIR– The windshield washer reservoir is located on the rear of the cab (fig. 116-2). Check it occasionally and refill it with non-refreezing automotive windshield cleaner as required.



FIG 116-2

VII. SERVICE AND MAINTENANCE

B. FLUIDS

FUEL

TYPE– No. 2 diesel fuel is recommended for the best economy and performance under most operating conditions. In operating conditions under 32°F, use a blend of No. 1 and No. 2 diesel fuel. The addition of No. 1 diesel fuel may cause loss of power and/or fuel economy.

STORING–See section 6 on storage.

REFUELING– Always turn off the engine and allow it to cool before refueling. Never smoke while fueling. Keep a fire extinguisher within reach while refueling.

The fuel cell on a STS holds 150 gallons– do not fill it completely: fuel can expand and run over. Wipe up all spilled fuel and clean with detergent and water before starting the engine.

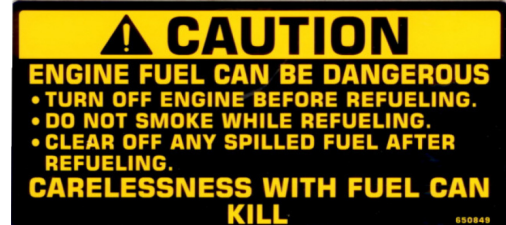

AIR CONDITIONING

TYPE– The cab on your sprayer is equipped with a R-134a air conditioning system (fig. 117-2).

RECHARGING– Recharge it only with R-134a refrigerant. If your air conditioning system is mistakenly charged with R-12 refrigerant, serious problems, such as compressor seizure, may result. Therefore, confirm refrigerant before recharging system.

If you do not have the proper recharging equipment, it is recommended that you allow an independent service agent service your air conditioning system.

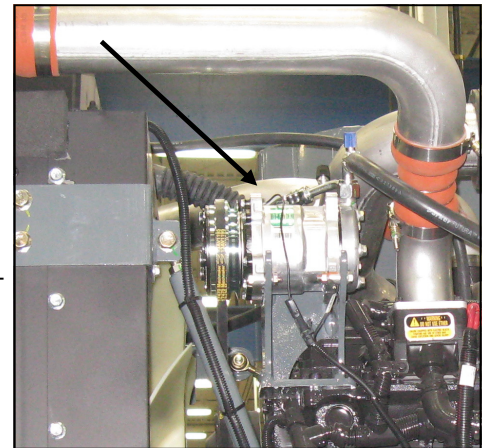

FIG 117-2

FLUID CAPACITIES AND TYPES

Engine oil pan, including filter	18.5 quarts SAE 15W-40
Engine oil dipstick, L-H mark.....	2 quarts
Hydraulic oil reservoir.....	32 gallons anti-wear hydraulic oil
Hydraulic system (reservoir, lines, filter, cooler, etc)	55 gallons
Wheel hub oil level	
Bonfiglioli wheel hub (4).....	approx. 40 oz. ea
Engine cooling system	18 gallons ethylene glycol
Fuel cell	150 gallons No. 1 or 2 diesel

VII. SERVICE AND MAINTENANCE

C. FILTERS

ENGINE AIR INTAKE

LOCATION– The engine air intake filter is accessed by opening the door on the front of the engine compartment (fig. 118-1).

REMOVAL– The engine air intake filter element should only be removed if it is going to be replaced. After loosening the air cleaner clamp and removing the end cap, carefully remove the filter so as to not knock any dust off the filter and into the air intake passage (fig. 118-2). The secondary filter does not need to be replaced if the primary is intact.

REPLACEMENT– Your sprayer is equipped with a Filter Minder® to notify you of filter element efficiency. Follow its guidelines for servicing (see below). At appropriate service time, install the new element carefully to ensure proper sealing.

CLEANING– It is not recommended to clean the air intake filter element. However, a clean damp cloth should be used to wipe away dust and foreign material from the air cleaner housing.



FIG 118-1

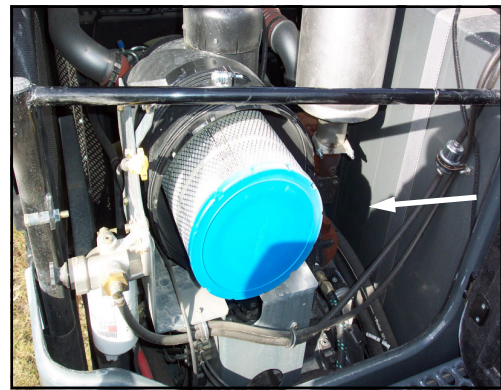

FIG 118-2

NOTE:

Do not tap filter to remove dust. Engine damage may occur due to crushed filter caused by tapping. If Filter Minder® indicates restriction, remove old filter, discard and install new filter only.

FILTER MINDER®

LOCATION– The Filter Minder® is an air restriction monitoring system that progressively and constantly indicates how much air filter capacity remains. It is mounted on the foamer bracket (fig. 118-3).

Check its reading daily.

SERVICE–

Service the air cleaner when the Filter Minder® reads 20" (80% of dirt holding capacity).

NOTE:

Service the air cleaner before the yellow indicator reaches the red line of the Filter Minder®.



FIG 118-3

VII. SERVICE AND MAINTENANCE

C. FILTERS

RADIATOR SCREEN– In order to maintain air flow through the engine cooling system’s radiator, oil cooler, and air conditioning condenser, the cooling air intake grille (fig. 119-1) must be inspected often and periodically cleaned.

When the engine hood has been opened for servicing, use compressed air to dislodge most large trash and dirt. Blow out the screen *AWAY* from the machine. Water from a pressurized hose may also be used, or if necessary the screen may be soaked with soapy water and scrubbed gently with a brush.

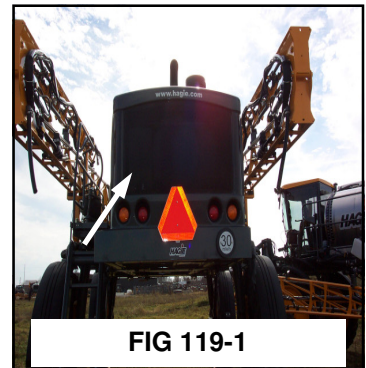

FIG 119-1

NOTE:

When cleaning cooling fins of the radiator, oil cooler, or A/C condenser with compressed air or water, be careful not to damage cooling fins which may impair cooling capabilities.

NOTE:

Failure to keep cooling systems clean can cause over heating and damage to the hydrostatic system and/or engine.

HYDRAULIC FILTER AND STRAINERS

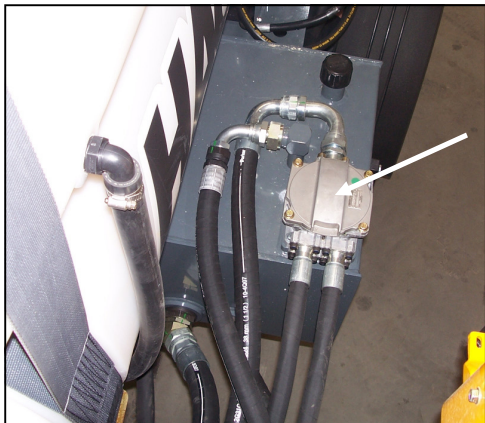

FIG 119-2

RETURN FILTER- Remove and install a new 10 micron rated return filter (fig. 119-2) at the end of the first 50 hours of use, subsequently replace the filter every 250 hours, or once a year, whichever comes first.

SUCTION STRAINERS– The suction strainers located inside of the tank should be examined for wear and blockage when the tank is empty for fluid service (see page 114).

FILL SCREEN- Replace the fill screen immediately if there is any signs of a tear or break. The screen is the first defense against

foreign materials entering the tank.

VII. SERVICE AND MAINTENANCE

C. FILTERS

ENGINE LUBE FILTER- The engine lube filter (oil filter) (fig. 120-1) should be changed every 500 hours or anytime that the oil is changed.

The filter is located under the service platform, behind the right rear wheel. It is accessible from the ground level.



FIG 120-1

FUEL FILTERS AND STRAINERS

REMOTE FUEL FILTER- (fig. 120-2) Located near the air intake filter, this filter should be replaced every 500HRS or once a year, whichever comes first.



FIG 120-2

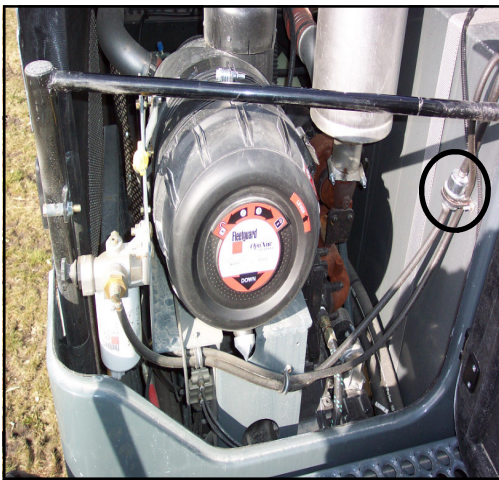

FIG 120-3

PRIMARY FUEL FILTER (WATER SEPARATOR)- (fig. 120-4) Located on the right side of the engine, this filter should be drained daily of the water and other deposits. Replace the filter every 500 hours or as necessary.

IN LINE STRAINER- (fig. 120-3) Located on the right hand side of the engine, above the air filter. Note the direction of the fuel flow arrow when replacing.



FIG 120-4

VII. SERVICE AND MAINTENANCE

C. FILTERS

OTHER STRAINERS

POLY RINSE TANK STRAINER– If you have the pressure washer option on your sprayer you will have a 100 mesh strainer in the line from the rinse tank to the pressure washer (refer to Hagie STS 14 Combo Parts Manual for location). Check the strainer for blockage if you are unable to get pressure.



FIG 121-1

RINSE STRAINER– The poly tanks have a 150PSI (32 mesh) strainer in the line from the rinse valve to the solution tank rinse. If you are experiencing issues with pressure through your rinse cycle, you may check this strainer.

SOLUTION LINE “Y” STRAINER– To help maintain consistent application rates, check the solution line strainer (fig. 121-1) daily for blockage. Clean the strainer screen as required. Be sure to wear appropriate clothing while removing and cleaning the line strainer screen. Confirm the gasket is in place before re-installing the screen.

Check all strainers occasionally for blockage and replace them if they show signs of deterioration. Refer to the Hagie Parts Manual for replacement part numbers and specific locations.

FRESH AIR CAB FILTERS

PAPER FILTER– The paper filter should be cleaned every 50 hours, or more often if necessary. Remove the paper element and gently tap it against a flat surface. Direct low pressure compressed air through the filter to remove larger particles. Replace the paper filter if necessary.

CHARCOAL FILTER– Remove and replace the charcoal filter at the first signs of chemical odor entering the cab.



FIG 121-3

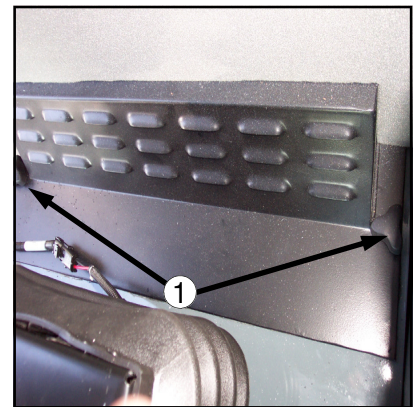

FIG 121-2

To remove, clean, or replace the filters in the cab, undo the thumb screws on the cover (figure 121-2, item 1) and carefully remove the filters. Wipe the cover clean with a damp cloth and allow to dry before replacing.

Figure 121-3 shows the air tube that allows fresh air into the cab. Check it often for any material blocking the opening.

VII. SERVICE AND MAINTENANCE

D. LUBRICATION

LEGS AND STEERING– The front legs have a grease zerk in the tie rod ball (figure 122-1, item 1) that needs greased every 50 hours or weekly.



FIG. 122-2

Both the front and rear legs have two grease zerks, one in each of the tower bearings (figure 122-1, item 2) that must be greased every 50 hours or as necessary. There is a zerk in the collar (figure 122-1, item 3) that also needs greased every 50 hours or as necessary.

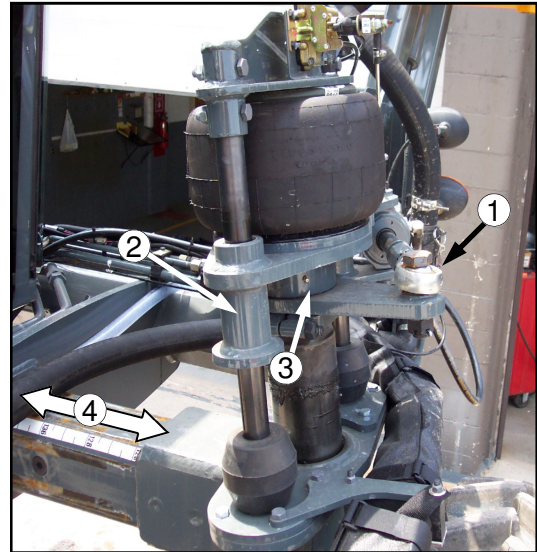

FIG. 122-1

The slide path of the tread adjust (figure 122-1, item 4) should be greased every 50 hours depending on the amount of usage.

Each leg also has a grease zerk on the inside of the leg (fig. 122-2) that should be greased every 50 hours. Tall crops may wipe away much of the grease, be sure to check each leg daily.

NOTE:

Failure to properly lube pivot points may result in unnecessary wear and damage.

NOTE:

DO NOT use air-type grease gun to lube leg towers, may result in seal distortion.

TRANSOM PIVOT TUBES– The transom pivot tube that attaches the booms to the transom has a grease zerk that should be greased every 50 hours or as needed depending on the amount of use.

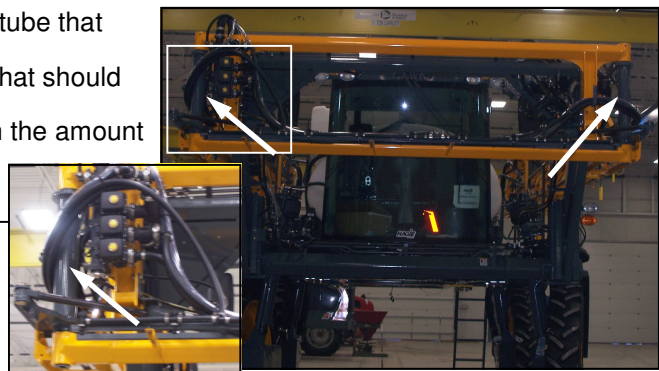

FIG 122-3

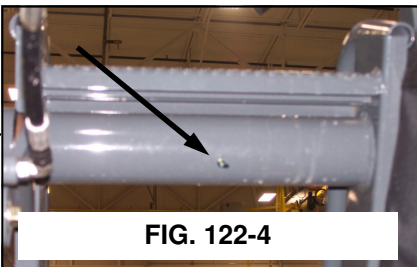

FIG. 122-4

LADDER– The ladder pivot tube (figure 122-4) has a grease zerk that needs to be lubed every 50 hours or as needed.

VII. SERVICE AND MAINTENANCE

D. LUBRICATION

QUAD PULLERS- Each quad puller head has four bearings equipped with grease zerks (fig. 123-2). To ensure the longest life and best performance, grease each bearing twice a day: suggested times are morning and noon.

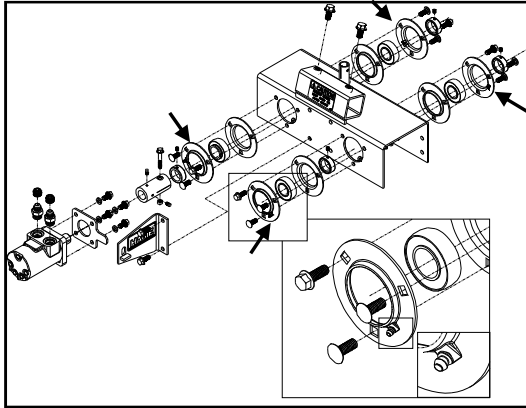

FIG 123-2



FIG 123-1

NOTE:

Failure to properly lube pivot points may result in unnecessary wear and damage.

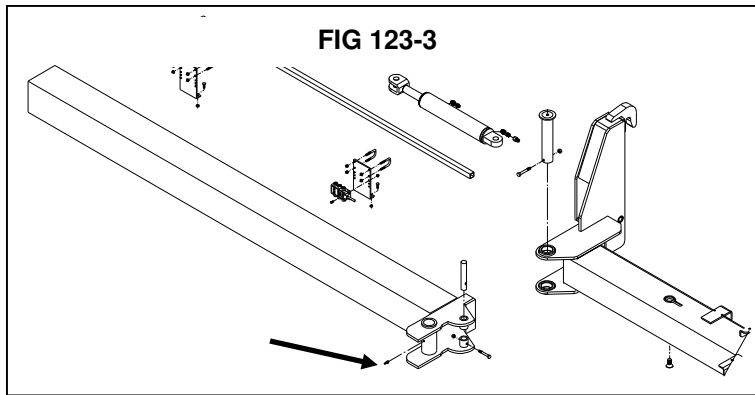

FIG 123-3

OUTRIGGER FOLD-The left and right outriggers have a grease zerk in the folding joint between the center tool bar and the either outrigger (fig. 123-3).

When the combo is being used, this zerk should be greased a minimum of every 50 hours.

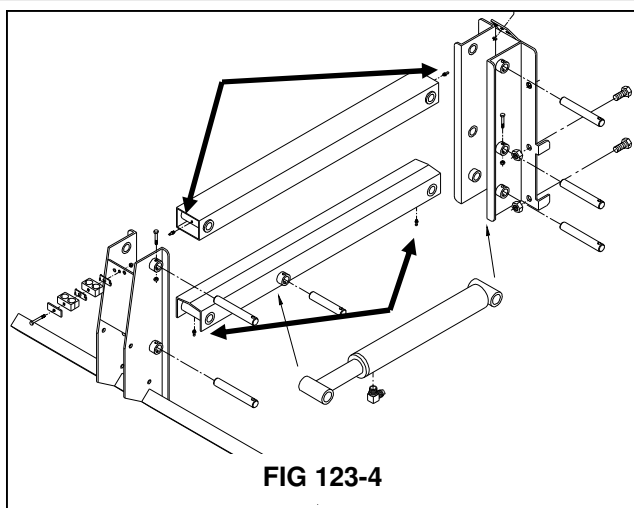

FIG 123-4

LIFT ARM ASSEMBLIES-Each lift arm assembly has four grease zerks. There is one zerk at each end of the upper and lower lift arms (fig. 123-4).

When the combo is being used, these pivot points need to be checked daily and greased a minimum of every 50 hours.

VII. SERVICE AND MAINTENANCE

E. ELECTRICAL

BATTERIES

SERVICE ACCESS– The batteries are located at the rear of the machine behind the battery service access panel. (fig. 124-1)

CLEANING– Disconnect the battery cables from the batteries. Remove all corrosion with a wire brush or battery post brush. Wash the cable connections and battery posts with a weak solution of baking soda or ammonia. Apply dielectric or grease to prevent further corrosion. Reconnect the cables to the batteries making sure that they are tight. Clean every 100 hours.

CHARGING– To ease charging of the batteries, there is a set of auxiliary battery charging posts on the rear of the sprayer's mainframe (fig. 124-2). Connect your charging cables to them just as you would to the battery, positive cable to positive terminal, and negative cable to negative terminal. Keep these terminals clean and their caps in place when not in use.



FIG 124-1

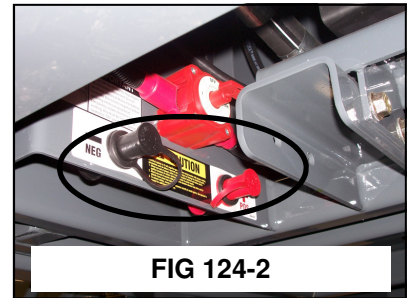

FIG 124-2



CAUTION

Batteries contain sulfuric acid. Avoid contact with skin, eyes, or clothing. Do not inhale fumes or ingest liquid. Batteries contain gases which can explode. Keep sparks and flame away while servicing.

Install replacement batteries with ratings equivalent to the specs below.

VOLTAGE 12 V (only)

CCA (30 sec. at 0° F)..... 950

RESERVE CAPACITY 185 min.
at 25 amps

NOTE:

To ensure the best electrical contact, battery terminal connections should be as clean and as tight as possible.

NOTE:

When servicing the electrical system always disconnect the batteries. Remove the ground cable first and connect it last.

VII. SERVICE AND MAINTENANCE

E. ELECTRICAL

CIRCUIT BREAKERS & FUSES– The STS Combo has circuit breaker and fuse systems in various locations. Under the right hand console (fig. 125-1) for the cab functions, under the cab (fig. 125-2) for the light functions, and the engine compartment (fig. 125-3) for the engine functions. The combo unit has an electrical box (fig. 125-4) that houses a 20 amp circuit breaker, ten 12V micro relays, and a terminal strip.

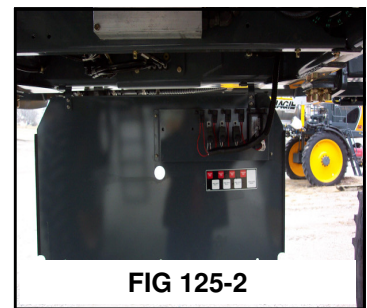
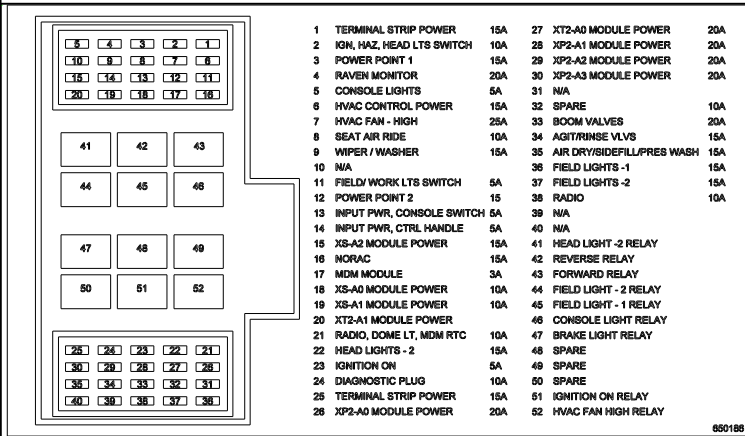
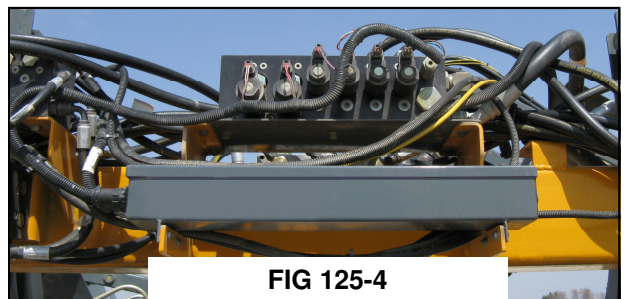
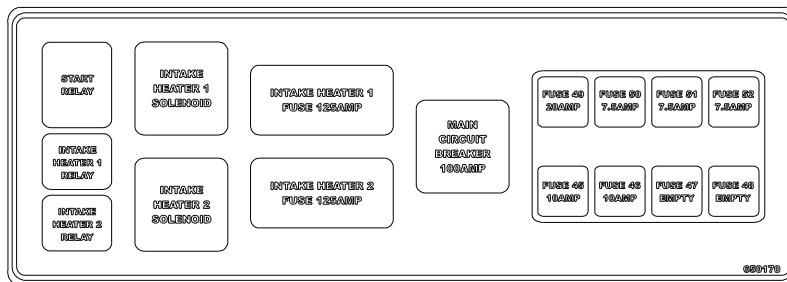

FIG 125-3



VII. SERVICE AND MAINTENANCE

F. BELTS

ENGINE DRIVE BELT

REMOVAL– Insert a 1/2 inch square ratchet drive (fig. 126-1) into the belt tensioner (fig. 126-2, item 1) and lift upward to remove the belt (fig. 126-2, item 2).

INSPECTION– Visually inspect the belt daily. Check the belt for intersecting cracks (fig.

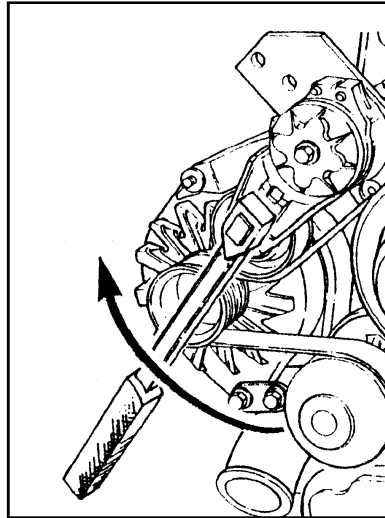

FIG 126-1

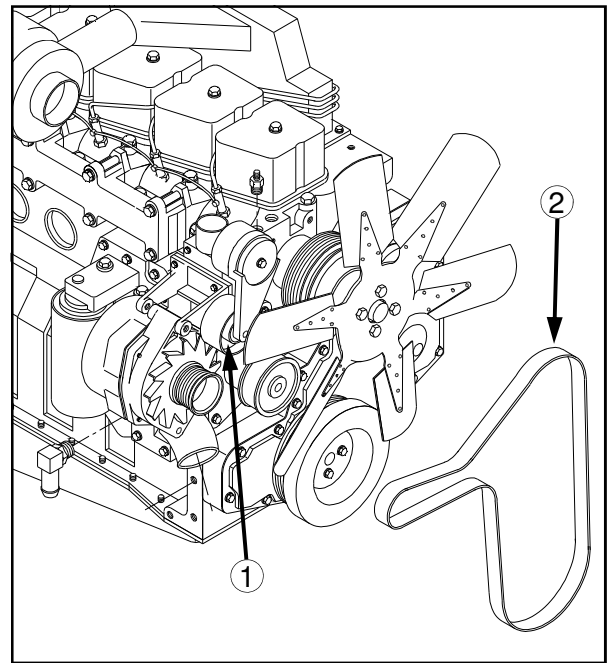

FIG 126-2

126-3). Transverse (across the belt width) cracks are acceptable. Longitudinal (direction of the belt length) cracks that intersect with transverse cracks are not acceptable. Replace the belt if it is frayed or has pieces of material missing.

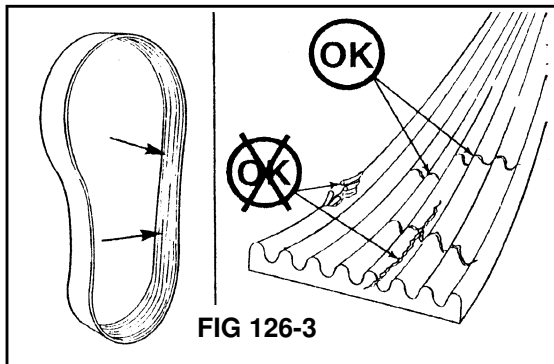

FIG 126-3

A/C COMPRESSOR BELT– To tighten air conditioner compressor belt, loosen the two pivot bolts (fig. 126-4, item 1) and the two slide bolts (fig. 126-4, item 2). Using a suitable prying tool, adjust tension on the belt to the desired tautness. While maintaining tension, re-tighten all four bolts. Inspect belt every 250 hours.

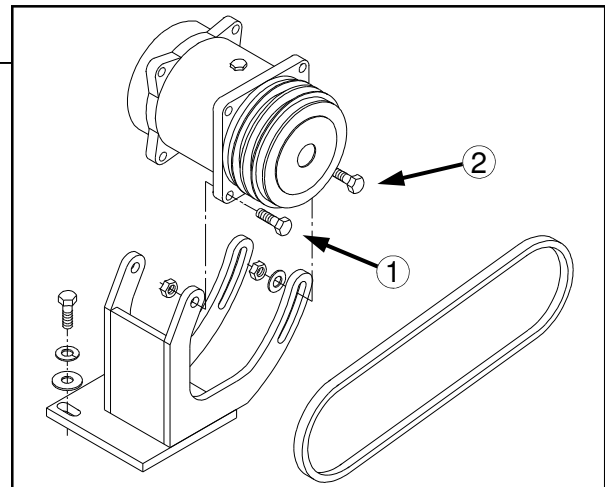

FIG 126-4

VII. SERVICE AND MAINTENANCE

G. BOLT TORQUE

WHEEL BOLTS– If you do not have the proper equipment to mount a tire, let your local qualified tire sales/service dealer mount the tire for you. The tire should be mounted on the rim according to figure 127-1 for best traction and tread cleaning action. To install wheel and tire assembly on the wheel hub lubricate studs with an anti-seize grease. Align the wheel bolt holes with the wheel hub studs and mount the wheel on the hub.

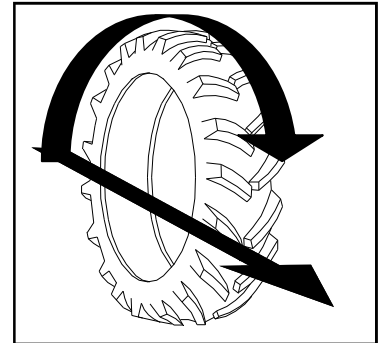

FIG 127-1

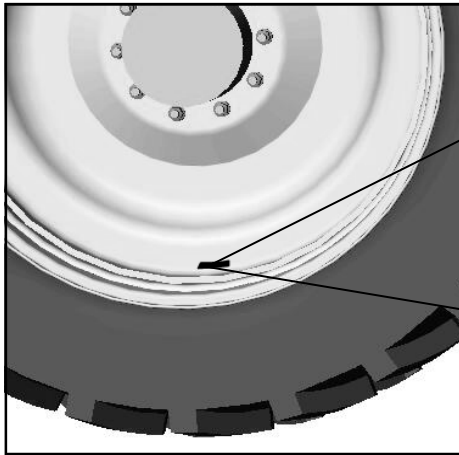

FIG 127-2

**Keep wheel bolts tight.
See owner's manual for
torque specifications.**

NOTE:

To achieve even torquing consistency, the tire should be completely off the ground.

Start all of the lug nuts and tighten them until they are just snug. Following the torque sequence in figure 127-3, first turn each lug nut to a torque value of 120 dry foot– pounds. Use slow, even pressure on the torque wrench. Quick or jerky movements cause inaccurate values. Repeat the same sequences to 150 dry foot– pounds and again finally to 400 to 500 dry foot– pounds.

If the wheel turns during lug nut torquing, lower the machine to the ground just enough for the tire to touch and prevent rotation or more preferably, place a suitable wedge between the tire and the ground.

Lower the machine and resume operation. Recheck torque after 30 minutes of operation.

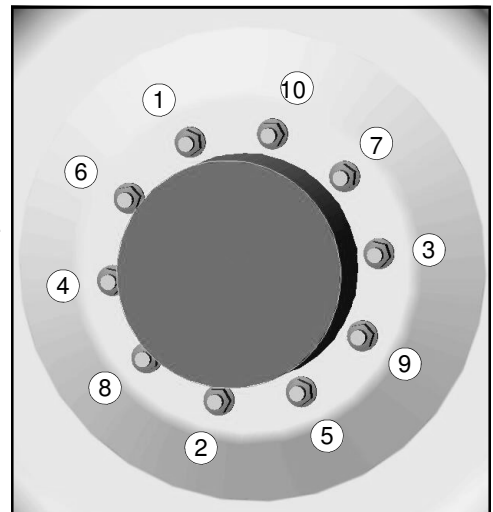

FIG 127-3



CAUTION

Check lug nut torque immediately after receiving machine and every 50 hours thereafter.

VII. SERVICE AND MAINTENANCE

G. BOLT TORQUE

HYDRAULIC TREAD ADJUST UNITS– With the engine turned off, visually inspect the tread bearing bolts on both the bottom and side tread adjust bearing plates (fig. 128-1) every 50 hours. Torque check them every 100 hours.

To torque check the tread adjust bearing bolts:

1. Loosen the jam nut (fig. 128-1, item 2) on each tread adjust bearing bolt.
2. Using an “X” pattern (fig. 128-2), verify that current torque on each tread adjust bearing bolt is equivalent to the last check from 100 hours previous.
3. Repeat pattern 3 to 4 times until last sequence shows no movement of the bolts to achieve desired torque.
4. Tighten jam nut.

Typically a torque value of 20 to 25 foot pounds is required to stabilize the axle and still allow tread width adjustment.

Even pressure of the tread adjust bearing plates is required for proper operation! (fig. 128-3) Figure A shows the correct position of the tread adjust bearing plates and bolts as well as the outer leg. Figure B shows the plates when there is not even torque on each of the tread adjust bearing bolts. Figure C shows a situation in which there is not enough torque on the tread adjust bearing bolts. Both figure B and C will cause the tread adjust to operate incorrectly or not at all.

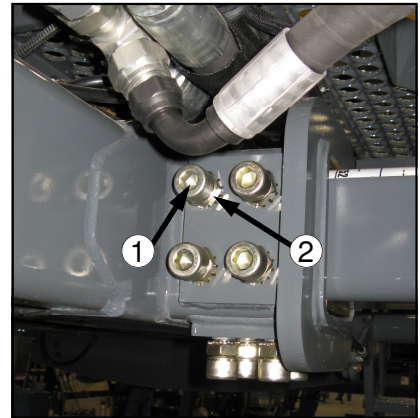

FIG 128-1

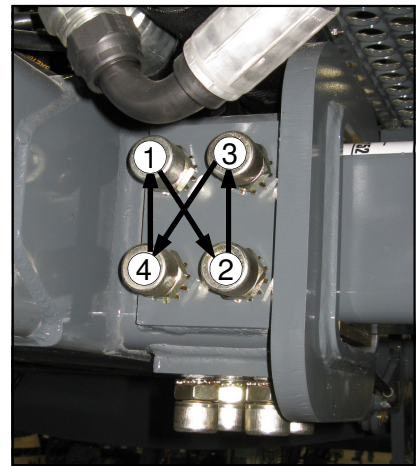

FIG 128-2

NOTE:

If hydraulic tread adjustment will never be used on your machine or you do not have hydraulic tread adjust, set all bearing bolt torque settings to 50 foot-pounds using the same procedure as stated above.

NOTE:

Never operate the unit with loose or missing tread adjust bearing bolts.

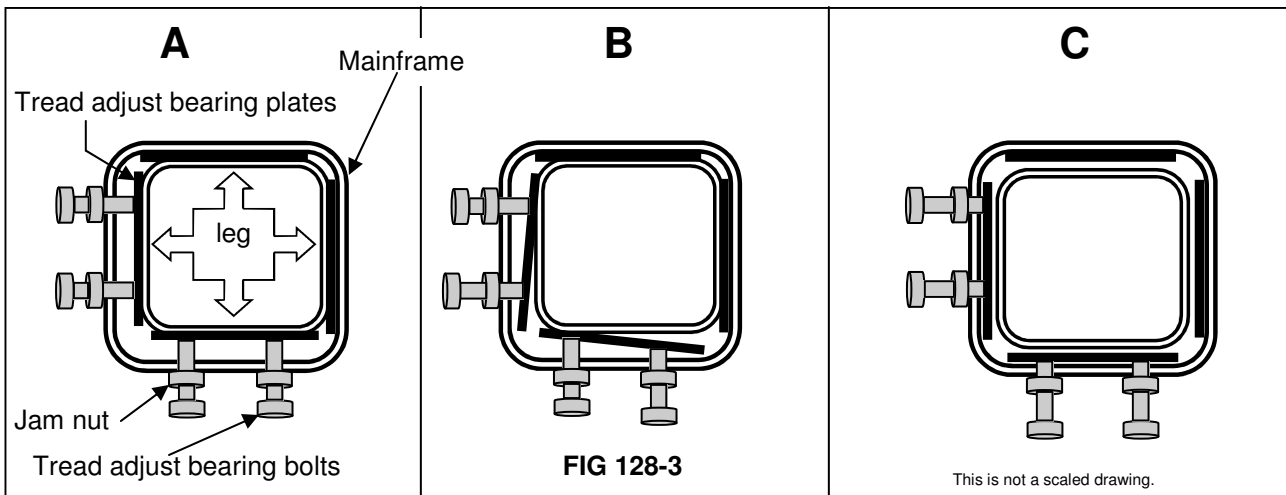

VII. SERVICE AND MAINTENANCE

H. TOE- IN

GAUGING TOE-IN- To correctly gauge toe-in, phase the cylinders first (page 41). Then use a tape measure placed at one-half the height on the front center seam of the front tire compared to the same measurement of the rear of the front tire (subtract the front measurement from the rear measurement— it must be a positive number). Correct toe-in should fall between one half and three quarters of an inch.

Toe-in is preset at the factory and should not have to be adjusted unless the steering cylinders are removed.

Difficulty steering one way versus the other or “darting” during operation, may indicate incorrect toe-in and may require adjustment.

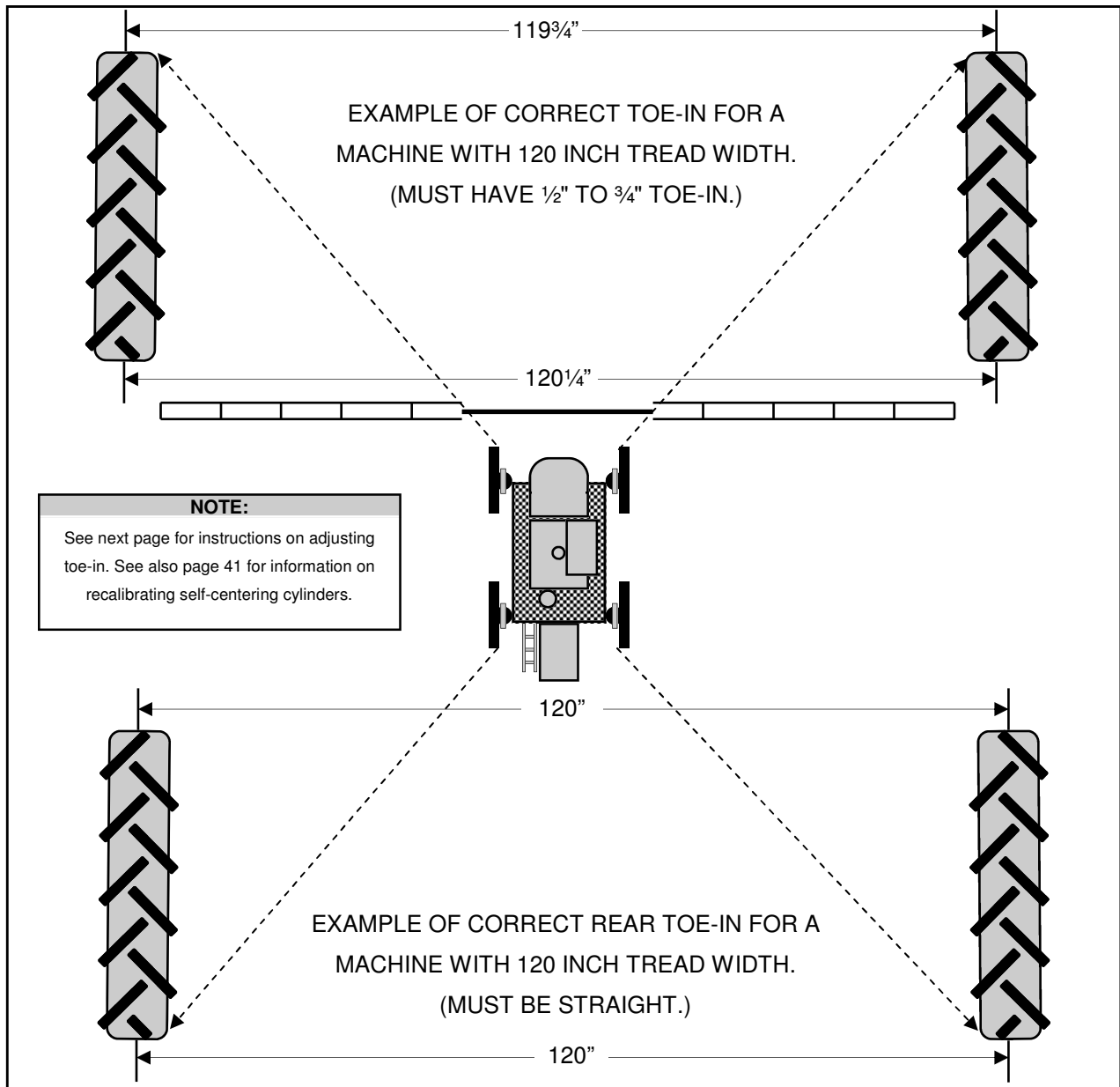

FIG 129-1

VII. SERVICE AND MAINTENANCE

H. TOE-IN

TOE-IN ADJUSTMENT– To adjust toe-in of the front tires follow these instructions for both front steering cylinders carefully:

1. Phase the cylinders (page 41), stopping at “center” .
2. Loosen jam nut (fig. 130-A).
3. Screw swivel assembly in or out on steering cylinder until the measurement from the center of the rod end to the collar (fig. 130-1, item B) is the same on both of the front steering cylinders.
4. Tighten jam nut.
5. Phase cylinders again, re-check toe-in measurement. The cylinders must be phased anytime an adjustment is made to the cylinders.
6. Drive forward 30 to 50 feet and re-measure toe-in.
7. Repeat steps 2-6 until a correct toe-in measurement is reached.

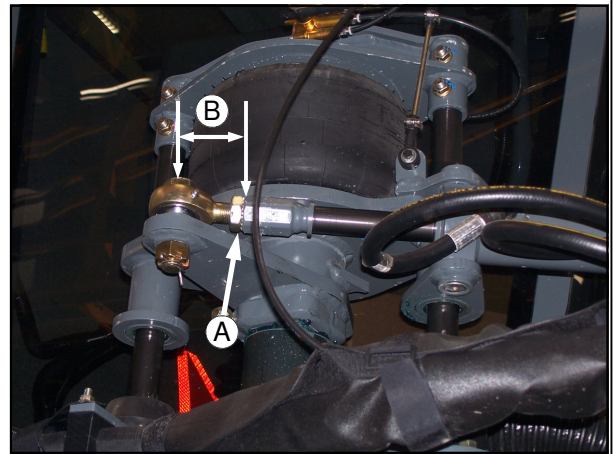

FIG 130-1

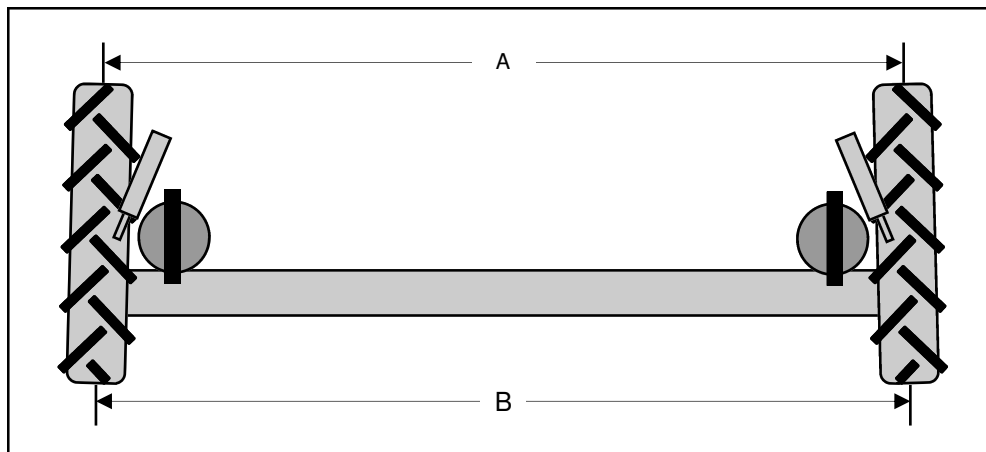

FIG 130-2

NOTE:

Dimension “A” should be $\frac{1}{2}$ ” to $\frac{3}{4}$ ” less than dimension “B.” For more information regarding toe-in, see page 129.

VII. SERVICE AND MAINTENANCE

I. AIR PRESSURE

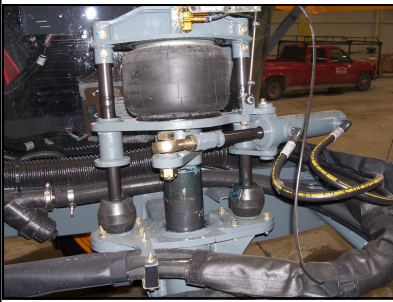

FIG 131-1

AIR BAG PRESSURE– The airbags (131-1) automatically adjust pressure to compensate for load weight and field conditions. The system includes an air dryer (fig. 131-2) that dries the air coming from the air compressor before sending it to a collection tank. Check the dryer cartridge every 50 hours to make sure that it is purging with compressor unload. Change the cartridge as needed or every other season (1000 hours).



FIG 131-2

From the collection tank, the air is sent to the airbags located on the legs (fig. 131-1) as needed to maintain a level pressure. There are control valves on each leg that open and close to allow air in.

Visually check the air bags daily for leaks and cracking. If an air bag seems to be low check the bag for any punctures or leaks. Call Hagie Customer Service for repairs.



FIG 131-3

WET TANK– Drain the wet tank (fig. 131-3) daily to prevent system condensation from contaminating the engine air compressor or dryer.

is excessive moisture in this tank, there may be a problem with the system. Call Hagie Customer Support for assistance.

AIR TANK– Drain the air tank (fig. 131-4) daily by slowly releasing the drain cock. Check for moisture in the system. If there

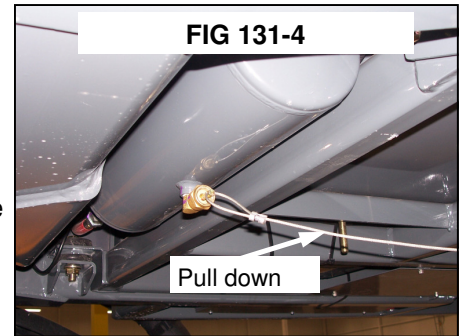

FIG 131-4

TIRE PRESSURE– Check the pressure once a week or every 50 hours of operation (fig. 131-5). Never inflate a tire more than the recommended maximum air pressure. Use an air line with a locking air chuck and stand behind the tire tread while filling (fig. 131-6).



FIG 131-5



FIG 131-6

NOTE:

Tire pressure will depend on tire type and load quantity in solution tanks. Refer to page 20 for tire specifications.



WARNING

When inflating tire use extension hose with in-line air gauge and clip-on air chuck, which allow operator to stand clear of tire side wall explosion trajectory.

VII. SERVICE AND MAINTENANCE

J. SPRAY SYSTEM

SPRAY TIPS— At the beginning of each season, or as required, remove a random sample of spray tip caps (fig. 132-3, item C) and inspect the nozzle tips. If they are plugged or worn, clean or replace them. **DO NOT** put your mouth to a spray tip to try to unplug it!

NOZZLE DIAPHRAGMS— At the beginning of each season, remove each nozzle body cap (fig. 132-3, item A) and inspect the diaphragm (fig. 132-3, item B) for wear or fit. Replace if necessary. Refer to accompanying manual containing nozzle information.

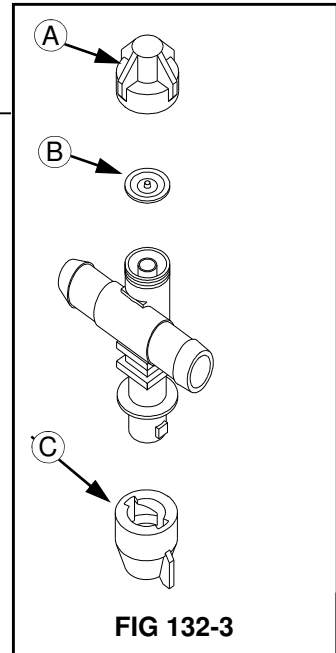

FIG 132-3

VIII. STORAGE

A. PREPARING FOR STORAGE

1. Perform daily level checks, lubrication, and bolt and linkage inspections as required in this manual in section five on maintenance.
2. Every other season, drain the coolant from the engine and radiator. Probe the drain holes during draining to ensure they are not clogged by sludge, scale, or other deposits. Fill the cooling system to the top with a 50/50 water/antifreeze mixture. Run the engine to operating temperature and re-check the level.
3. Add a fuel stabilizer to the fuel and fill the tank.
4. Run the engine until it is at operating temperature, then drain the engine oil. Refill with fresh oil of recommended weight and install a new lubricating oil filter element.
5. With the engine at normal operating temperature, cycle all hydraulic functions including the steering.
6. Release tension on all belts.
7. Use plastic bags and water resistant adhesive tape to seal the air intake opening, all exhaust manifold openings, engine oil filter cap, hydraulic oil tank breather cap, and fuel tank caps.
8. Disconnect and remove batteries. Completely clean and charge the batteries. Coat the terminals with dielectric grease and store the batteries in a cool, above freezing place.
9. Thoroughly clean the sprayer. Touch up any painted surfaces that are scratched or chipped. For touch up paint recommendations contact the Hagie Manufacturing Customer Support Department.
10. Replace worn or missing decals. See Section 1 for proper location of warning decals and their corresponding part number. Warning decals and all other Hagie decals are available through the Hagie Customer Support Department.
11. Use a multi-purpose grease to coat exposed hydraulic cylinder rods.
12. To winterize the spray system, it is recommended that you use an environmentally safe type antifreeze and water mixture that will give you adequate protection to minus 30 degrees below zero. Drain any remaining solution in the spray system and run the antifreeze mixture through the spray system until it comes out all boom openings. Repeat the above process with both the foam marker and rinse systems.
13. Refer to the Raven manual for detailed information on storage procedures for the monitor and flow meters.
14. If the sprayer must be stored outside, cover it with a waterproof cover.

NOTE:

If antifreeze is added, make sure the engine is then run to operating temperature to assure proper mixing of solution.

NOTE:

For replacement decals contact:
Hagie Manufacturing Company
721 Central Ave. West
Box 273
Clarion, IA 50525-0273
Ph. 1-800-247-4885

VIII. STORAGE

B. REMOVING THE SPRAYER FROM STORAGE

1. Inspect the condition, and test the air pressure of all the tires.
2. Carefully unseal all openings that were sealed in the storage process.
3. Clean and reinstall the batteries. Be sure to attach the battery cables to the proper terminals.
4. Tighten all belts. Inspect and replace any worn belts.
5. Check the engine oil, hydraulic oil, and engine coolant levels; add if necessary. A mixture of 50/50 anti-freeze and water will cool adequately in summer as well as protect in winter.
6. Completely clean the sprayer.
7. Review section five on maintenance and perform all needed services as instructed.
8. For starting instructions, refer to Section 4 on operating information.

NOTE:

Protective compounds such as grease can harden under exposure to weather conditions. Be sure to remove any dried grease and re-apply new if necessary.

NOTE:

See Warranty concerning **improper storage.**

IX. TROUBLE SHOOTING

A. ENGINE



CAUTION

Start engine from operator's seat only. When running engine in a building, be sure there is adequate ventilation.

PROBLEM	POSSIBLE CAUSE	SUGGESTED REMEDY
Engine won't crank	<ul style="list-style-type: none"> • Dead battery • Poor battery connections • Starter or starter relay • Blown fuse in engine electric box • Battery switch in OFF position 	<ul style="list-style-type: none"> • Recharge or replace battery • Clean and tighten • Test; rebuild or replace • Check 20 amp fuse • Turn battery switch to ON position
Engine won't start	<ul style="list-style-type: none"> • Out of fuel • Clogged fuel filter • Cold weather • Low starter speed • Blown fuse in engine electric box 	<ul style="list-style-type: none"> • Fill fuel tank • Replace fuel filters • Refer to engine manual for cold weather starting • Check starter and battery • Check 20 amp fuse
Engine overheats	<ul style="list-style-type: none"> • Engine overloaded • Dirty radiator core or dirty grill screen • Faulty radiator cap • Loose or faulty fan belt • Faulty thermostat • Low coolant level 	<ul style="list-style-type: none"> • Reduce load • Remove all foreign material and clean all items • Replace cap • Tighten or replace fan belt • Replace thermostat • Refill to proper level with recommended coolant

IX. TROUBLE SHOOTING

A. ENGINE



Start engine from operator's seat only. When running engine in a building, be sure there is adequate ventilation.

PROBLEM	POSSIBLE CAUSE	SUGGESTED REMEDY
Engine misfires: runs uneven, low power	<ul style="list-style-type: none">• Water in fuel• Dirty air cleaner element• Poor grade of fuel• Fuel tank vent clogged• Clogged fuel filter	<ul style="list-style-type: none">• Drain, flush, replace filter, fill system• Replace element• Drain system, change to a better grade fuel• Open fuel tank vent in cap• Replace fuel filter
Engine knocks	<ul style="list-style-type: none">• Low oil level in crankcase• Cold engine	<ul style="list-style-type: none">• Add oil to full mark• Allow proper warm-up period; refer to engine owner's handbook

IX. TROUBLE SHOOTING

B. SPRAY SYSTEM



WARNING

CHEMICALS ARE DANGEROUS

Read The Chemical manufacturer's labels to avoid injury or damage.

PROBLEM	POSSIBLE CAUSE	SUGGESTED REMEDY
Solution pump will not prime	<ul style="list-style-type: none"> • Low water level in pump • Air leak in suction line • Solution tank valve closed 	<ul style="list-style-type: none"> • Make sure the solution tank is not empty, solution pump is self-priming • Inspect and tighten all fittings on suction line • Open solution tank valve, allow air to leave the system
Erratic reading on pressure gauge	<ul style="list-style-type: none"> • Orifice in back of gauge clogged • Faulty gauge • Air leak in suction line • Glycerin leaking from gauge 	<ul style="list-style-type: none"> • Remove gauge; clean orifice; reinstall • Replace gauge • Inspect and tighten all fittings in suction line • Replace gauge
Malfunction of electric solution valve	<ul style="list-style-type: none"> • Faulty ground • Dirty contact terminals • Separation in wire • Faulty switch • Short in solenoid coil • Bad valve 	<ul style="list-style-type: none"> • Clean and tighten ground • Clean contact terminals • Check continuity and replace wire • Replace switch • Replace valve • Replace valve

IX. TROUBLE SHOOTING

B. SPRAY SYSTEM

NOTE:
 If your unit is equipped with a high-pressure system, call the Hagie Manufacturing Customer Support Department for possible causes and suggested remedies.

PROBLEM	POSSIBLE CAUSE	SUGGESTED REMEDY
Solution pump not producing normal pressure	<ul style="list-style-type: none"> • Clogged line strainer screen • Air leak in suction flow to pump • Restricted solution flow to pump • Suction hose collapsed • Internal restriction of diaphragm such as build up of chemical • Hydraulic failure 	<ul style="list-style-type: none"> • Remove screen; clean thoroughly; tighten strainer cap to avoid air leak • Inspect and tighten all fittings on suction line • Main solution tank shut-off valve not completely open • Obstruction at inlet end of hose causing high vacuum on hose • Disassemble; inspect; clean; reassemble • Call Hagie Customer Service

NOTE:
 Refer to the Raven installation and operation manual for trouble shooting guide on Raven console and system

IX. TROUBLE SHOOTING

C. HYDROSTATIC SYSTEM



PROBLEM	POSSIBLE CAUSE	SUGGESTED REMEDY
Machine won't move in either direction	<ul style="list-style-type: none"> • Speed control set too low • Engine speed too low • Oil level in reservoir too low • Clogged filter • Hydrostatic pump not turning 	<ul style="list-style-type: none"> • Adjust speed control knob • Set engine at operating RPM before trying to move machine • Fill reservoir to proper level with approved oil; see section on service and maintenance • Replace filter
External oil leaks	<ul style="list-style-type: none"> • Loose or faulty fittings • Damaged O-ring • Faulty hose 	<ul style="list-style-type: none"> • Tighten or replace • Inspect; if damaged replace • Replace hose

IX. TROUBLE SHOOTING

C. HYDROSTATIC SYSTEM



PROBLEM	POSSIBLE CAUSE	SUGGESTED REMEDY
Machine will move in only one direction	<ul style="list-style-type: none"> • Speed control set too low • Hydrostatic system failure 	<ul style="list-style-type: none"> • Adjust speed control knob • Call Hagie Customer Service
Hydrostatic system responding slowly	<ul style="list-style-type: none"> • Engine speed too low • Oil in reservoir low • Cold oil • Plugged filter • Partially restricted suction line • Hydrostatic system failure 	<ul style="list-style-type: none"> • Set engine at operating RPM before trying to move machine • Fill reservoir to proper level with approved oil; see section on service and maintenance • Allow adequate warm up period • Check and replace filter • Inspect for collapsed suction hose • Call Hagie Customer Service
Noisy hydrostatic system	<ul style="list-style-type: none"> • Cold oil • Low engine speed • Oil level in reservoir low • Hydrostatic system failure 	<ul style="list-style-type: none"> • Allow adequate warm up period • Increase engine speed • Fill reservoir to proper level with approved oil; see section on service and maintenance • Call Hagie Customer Service

IX. TROUBLE SHOOTING

D. HYDRAULIC SYSTEM



PROBLEM	POSSIBLE CAUSE	SUGGESTED REMEDY
Entire hydraulic system fails to function	<ul style="list-style-type: none"> Oil level in reservoir too low Auxiliary hydraulic system failure 	<ul style="list-style-type: none"> Fill reservoir to proper level with approved oil; see section on service and maintenance Call Hagie customer Service
Noisy hydraulic pump	<ul style="list-style-type: none"> Oil level in reservoir too low Auxiliary hydraulic system failure 	<ul style="list-style-type: none"> Fill reservoir to proper level with approved oil; see section on service and maintenance Call Hagie Customer Service

NOTE:

Refer to the Raven installation and operation manual for trouble shooting guide on Raven console and system

IX. TROUBLE SHOOTING

D. HYDRAULIC SYSTEM



PROBLEM	POSSIBLE CAUSE	SUGGESTED REMEDY
Lifting mechanism won't lift	<ul style="list-style-type: none"> • Bad cylinder • Blown relief valve • Relief valve set too low • Lift arms seized • Faulty electro-hydraulic valve 	<ul style="list-style-type: none"> • Check cylinder; remove and rebuild or replace • Remove, check, replace w/new • Contact Hagie Customer Service • Loosen mounting bolts; lubricate grease fittings if equipped • See Tasselrol®/LS and/or Tasselrol® trouble shooting guide
Cutter head blades, quad pullers, rollers, or tires won't turn	<ul style="list-style-type: none"> • Oil level in reservoir too low • Oil not reaching pump • Faulty hydraulic pump • Faulty hydraulic motor or motors 	<ul style="list-style-type: none"> • Fill reservoir to proper level with approved oil • Remove suction hose from pump, check for proper flow. Re-install hose and all suction fittings • Replace hydraulic pump • Replace motor or motors
Hydraulic motor leaking	<ul style="list-style-type: none"> • Seal failure • Restricted case drain hose 	<ul style="list-style-type: none"> • Replace seal; turn heads on with low engine RPM • Inspect or replace hose

IX. TROUBLE SHOOTING

E. ELECTRICAL

 **CAUTION**
 Batteries contain sulfuric acid. Avoid contact with skin, eyes, or clothing. Do not inhale fumes or ingest liquid. Batteries contain gases which can explode. Keep sparks and flame away while servicing.

NOTE:
 Disconnect battery when servicing any part of electrical system to prevent system damage.

PROBLEM	POSSIBLE CAUSE	SUGGESTED REMEDY
Entire electrical system is dead	<ul style="list-style-type: none"> • Dead battery • Poor battery connection • Low charging rate • No charging rate • Battery master switch is in OFF position 	<ul style="list-style-type: none"> • Replace battery • Clean and tighten battery connections • Tighten alternator belt • Replace alternator • Turn battery master switch to ON position
Light system does not function	<ul style="list-style-type: none"> • Poor ground • Burned out bulb • Separation or short in wire • Blown fuse • Faulty switch • Ignition switch is off 	<ul style="list-style-type: none"> • Clean and tighten ground • Replace bulb • Check continuity and replace wire • Replace fuse • Replace switch • Turn ignition switch to ON position

NOTE:
 Refer to the Raven installation and operation manual for trouble shooting guide on Raven console and system

IX. TROUBLE SHOOTING

F. HAGIE TASSELTROL®/ LS SYSTEM – HYDRAULIC



PROBLEM	POSSIBLE CAUSE	SUGGESTED REMEDY
No units will lift	<ul style="list-style-type: none"> • Oil in reservoir low • Faulty valve • Relief valve in electro-hydraulic valve set too low 	<ul style="list-style-type: none"> • Fill tank to proper level • Repair or replace valve • Contact Hagie Customer Service
No units will lower	<ul style="list-style-type: none"> • All lift arm pivots too tight 	<ul style="list-style-type: none"> • Lubricate and loosen pivot points
Only one unit will not lower	<ul style="list-style-type: none"> • Faulty valve • Lift arm pivot too tight 	<ul style="list-style-type: none"> • Replace valve • Lubricate and loosen pivot point
All units lift slowly	<ul style="list-style-type: none"> • Hydraulic oil not at operating temperature • Faulty valve • Lift arm pivots too tight • Relief valve in electro-hydraulic valve system set too low 	<ul style="list-style-type: none"> • Allow time for oil to warm up • Replace valve • Lubricate and loosen pivot points • Contact Hagie Customer Service
Only one unit lifts slowly	<ul style="list-style-type: none"> • Faulty valve • Lift arm pivot points too tight 	<ul style="list-style-type: none"> • Replace valve • Lubricate and loosen pivot point

IX. TROUBLE SHOOTING

F. HAGIE TASSELTROL®/ LS SYSTEM – HYDRAULIC



PROBLEM	POSSIBLE CAUSE	SUGGESTED REMEDY
Only one unit will not hold position	<ul style="list-style-type: none"> Oil leak between valve and cylinder Faulty valve Faulty lower poppet on lift valve 	<ul style="list-style-type: none"> Repair leak or replace hose Replace valve Remove, clean, replace
No units will hold position	<ul style="list-style-type: none"> Problem is not hydraulic 	<ul style="list-style-type: none"> See Tasselrol®- electrical section
Only one unit lowers slowly	<ul style="list-style-type: none"> Faulty valve Faulty lower poppet on the lift valve 	<ul style="list-style-type: none"> Replace valve Remove, clean, replace
All units lower slowly	<ul style="list-style-type: none"> Hydraulic oil not at operating temperature 	<ul style="list-style-type: none"> Allow time for oil to warm up
In "MANUAL" mode, more than one unit lifts or lowers from one up/down switch	<ul style="list-style-type: none"> Faulty valve 	<ul style="list-style-type: none"> Replace valve
In "AUTO" mode, more than one unit raises from photo sensor	<ul style="list-style-type: none"> Faulty valve 	<ul style="list-style-type: none"> Replace valve
In "AUTO" mode, wrong unit raises from photo sensor	<ul style="list-style-type: none"> Cylinder hoses are connected to the wrong cylinder 	<ul style="list-style-type: none"> Attach correct hoses to proper cylinder

IX. TROUBLE SHOOTING

G. HAGIE TASSELTROL® / LS SYSTEM – ELECTRICAL

MACHINE VALVE TYPE

o = any machines with the original valve model year 2007 and prior

p = 204/204SP machines with the new proportionate valve model year 2008 and later

c = STS Combination sprayer/ detasseler with the proportionate valve model year 2007 and later

NOTE:

Make sure that the machine valve type is correctly selected to match the machine that the Tasselrol® control box is installed on.

NOTE:

Disconnect battery when servicing any part of electrical system to prevent system damage.

PROBLEM	POSSIBLE CAUSE	SUGGESTED REMEDY
No units will lift	<ul style="list-style-type: none"> Faulty "AUTO/MANUAL" switch Blown fuse Faulty #1 valve, coil, or loose coil mounting nut Loose wire connections Faulty wire connections Faulty main wire assembly 	<ul style="list-style-type: none"> Replace switch Find short in wire, repair, and replace fuse Tighten or replace coil Find loose connection, tighten Replace or repair Replace or repair
Only one unit will not lift	<ul style="list-style-type: none"> In "MANUAL" mode: faulty "UP/DOWN" switch Light photo sensor assembly Faulty valve., coil, or loose coil mounting nut Loose wire connections Lights of photo sensor not lined up with reflector Faulty row wire assembly Faulty sensor connector wire assembly 	<ul style="list-style-type: none"> Replace control box Replace photo sensor Tighten nut or replace coil Find loose connections, tighten Line up sensor with reflector Replace or repair Replace or repair

IX. TROUBLE SHOOTING

G. HAGIE TASSELTROL®/ LS SYSTEM – ELECTRICAL

PROBLEM	POSSIBLE CAUSE	SUGGESTED REMEDY
No units will lower	<ul style="list-style-type: none"> • Faulty “AUTO/MANUAL” switch • Blown fuse • In “AUTO “ mode: LS valve assembly unplugged • Loose wire connections 	<ul style="list-style-type: none"> • Replace switch • Find short in wire, repair, and replace fuse • Plug in wire assembly • Find loose connection, tighten
Only one unit will not lower	<ul style="list-style-type: none"> • Faulty “UP/DOWN” switch • Light photo sensor assembly • Faulty valve, coil, or loose coil mounting nut • Loose wire connections • Lights of photo sensor not lined up with reflector • Faulty row wire assembly • Faulty sensor connector wire assembly 	<ul style="list-style-type: none"> • Replace control box • Replace photo sensor • Tighten nut or replace coil • Find loose connections, tighten • Line up sensor with reflector • Replace or repair • Replace or repair
No units will hold position	<ul style="list-style-type: none"> • In “AUTO” mode: no crop moving under assemblies 	<ul style="list-style-type: none"> • Drive forward or select “MANUAL” mode
In “AUTO” mode, wrong unit raises from sensor assembly	<ul style="list-style-type: none"> • Row LS wire assembly plugged into wrong sensor connector 	<ul style="list-style-type: none"> • Plug correct wire assembly into proper row sensor connector assembly

IX. TROUBLE SHOOTING

H. HAGIE TASSELTROL® DISPLAY TROUBLESHOOTING

To gain further information on the status of the Tasselrol®/LS system before operation: while sitting in the operator's seat, turn the ignition key to the "ON" position (do not start the engine); turn the Tasselrol® box to the "ON" position; turn the "AUTO/MANUAL" switch to "MANUAL."

Make sure there is nothing physically blocking any upper or lower sensor's path to its reflector.

The display will show the status of the upper and lower photo sensor on each lift assembly. If the display shows a box ("□") in all upper and lower areas, the unit is ready for operation. If the display shows a corn stalk ("Ÿ") in one or more areas, refer to pages 160-161 for further suggested remedies.

The LEFT-CENTER sensors are used as examples.

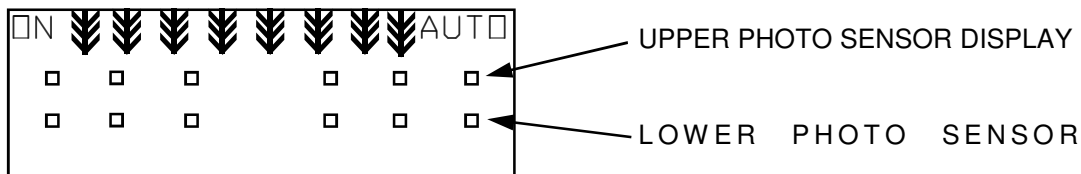

TASSELTROL® DISPLAY

MANUAL MODE

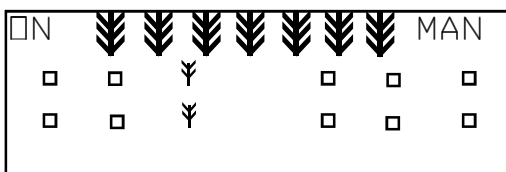

AUTO MODE

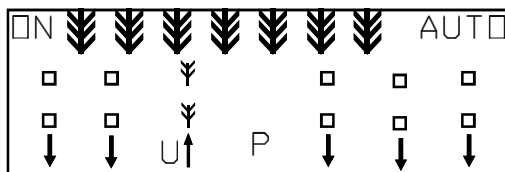

Unit rises automatically.

PHOTO SENSOR STATUS LIGHTS	POSSIBLE CAUSE
Lights at both photo sensors	Photo sensors not in line with reflector , call Hagie Manufacturing Customer Service.
No lights at either photo sensor	Faulty connector cable (See page 151, fig. 151-1, item 2) Faulty RED and/or BLACK wire in connector cable (See page 151, fig. 151-1, item 1)

IX. TROUBLE SHOOTING

H. HAGIE TASSELTROL® DISPLAY TROUBLESHOOTING

TASSELTROL® DISPLAY

MANUAL MODE

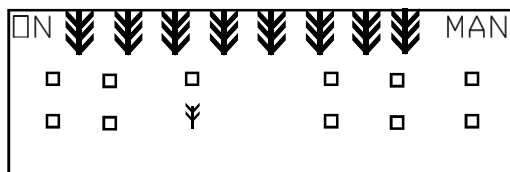

AUTO MODE

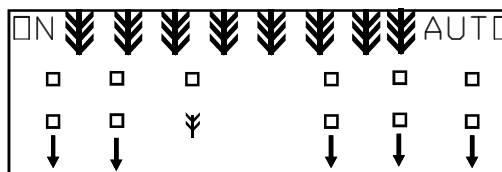

Unit does NOT rise automatically.

PHOTO SENSOR STATUS LIGHTS	POSSIBLE CAUSE
Lights at lower photo sensor	<p>Faulty GREEN wire in connector cable (See page 151 fig. 151-1, item 2)</p> <p>Photo sensor not in line with reflector , call Hagie Manufacturing Customer Support.</p> <p>Faulty BLUE wire in sensor assembly (See page 151, fig. 151-1, item 1)</p>
No lights at lower photo sensor	<p>Faulty RED and/or BLACK wire in connector cable (See page 151, fig. 151-1, item 2)</p>

IX. TROUBLE SHOOTING

H. HAGIE TASSELTROL® DISPLAY TROUBLESHOOTING

TASSELTROL® DISPLAY

MANUAL MODE

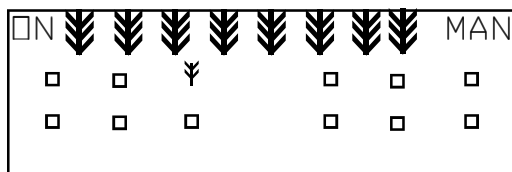

AUTO MODE

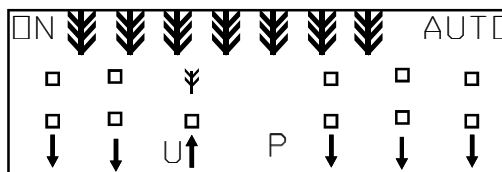

Unit rises automatically.

PHOTO SENSOR STATUS LIGHTS	POSSIBLE CAUSE
Lights at upper photo sensor	Faulty WHITE wire in sensor assembly (See page 151, fig. 151-1, item 1) Faulty BLUE wire in sensor assembly (See page 151, fig. 151-1, item 1)
No lights at upper photo sensor	Faulty RED and/or BLACK wire in connector cable (See page 151, fig. 151-1, item 2)

IX. TROUBLE SHOOTING

TASSELTROL® WIRE DIAGRAM

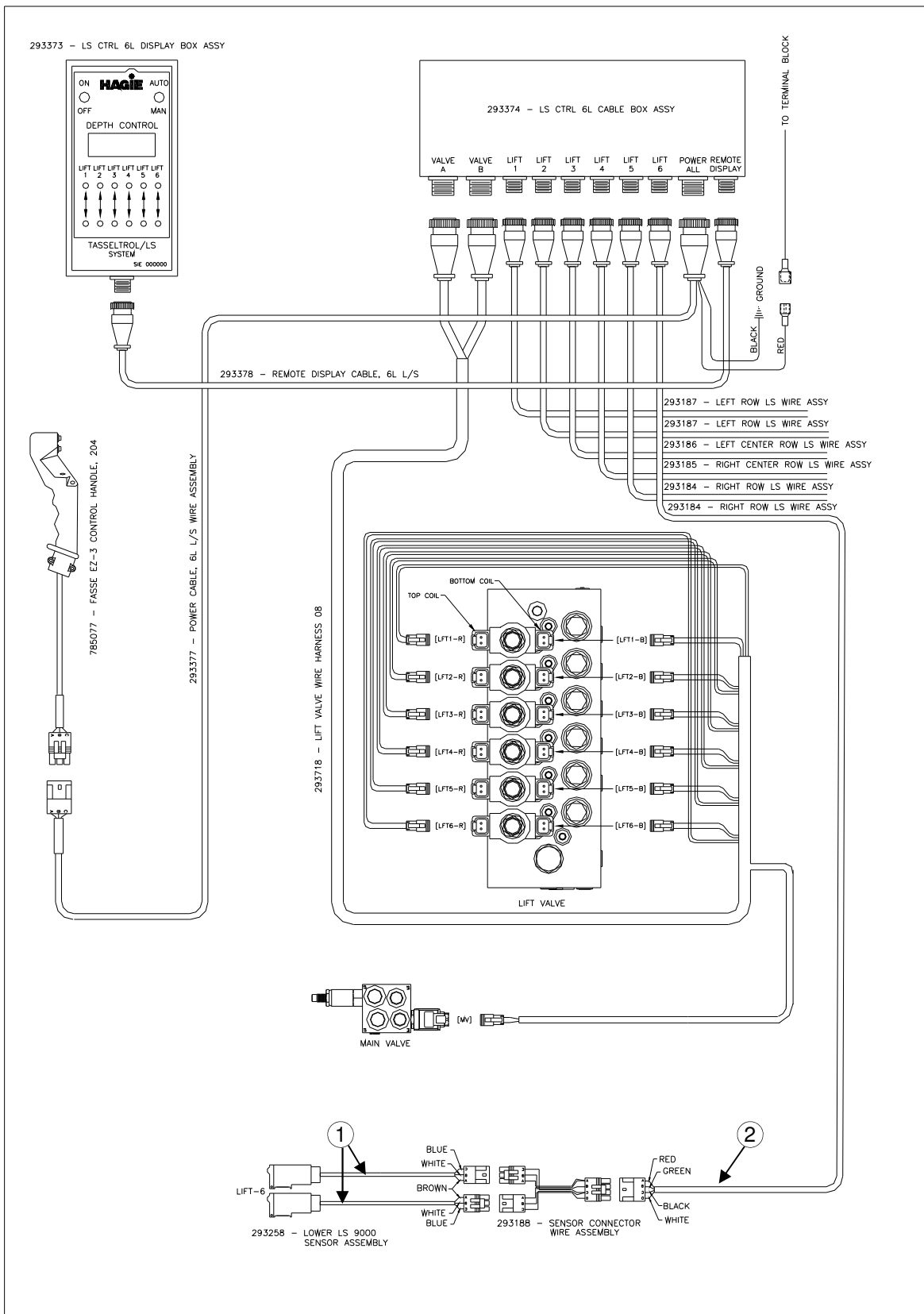

FIG 151.1

IX. TROUBLE SHOOTING

NOTES

X. LIMITED WARRANTY

Hagie Manufacturing Company Product Warranty

Hagie Manufacturing Company warrants each new Hagie (including Vammas by Hagie) product to be free under normal use and service from defects in workmanship and materials for a period of lesser of: two (2) years or 1000 hours from the date of delivery on all Agricultural Products and two (2) years or 2000 hours on all Vammas By Hagie Snow Removal Equipment (SRE). Hagie Manufacturing Company makes this warranty from the original delivery date and is transferable to a purchaser from the original purchaser of this equipment, given there is remaining time left under the year and hour warranty standard stated above. This warranty shall be fulfilled by repairing or replacing free of charge any part that shows evidence of defect or improper workmanship, provided the part is returned to Hagie Manufacturing Company within thirty (30) days of the date that such defect or improper workmanship is discovered, or should have been discovered. Labor to repair said items will be covered by standard labor time rates. Freight charges of defective parts are not covered by this warranty and are the responsibility of the purchaser. No other express warranty is given and no affirmation of Hagie Manufacturing Company, by words or action, shall constitute a warranty.

Hagie Manufacturing Company limits its warranty to only those products manufactured by Hagie Manufacturing Company (including Vammas by Hagie) and does not warrant any part or component not manufactured by Hagie Manufacturing Company (including Vammas by Hagie), such as parts or components being subject to their manufacturer's warranties, if any. Excluded from this warranty are parts subjected to accident, alteration, or negligent use or repair. This warranty does not cover normal maintenance such as engine tune ups, adjustments, inspections, nor any consumables such as tires, rubber products, solution system valves, wear parts, wiper blades, etc.

Hagie Manufacturing Company shall not be responsible for repairs or replacements which are necessitated, in whole or in part; by the use of parts not manufactured by or obtainable from Hagie Manufacturing Company nor for service performed by someone other than Hagie authorized personnel, unless authorized by Hagie Manufacturing Company. Customer acknowledges that it is not relying on Hagie Manufacturing Company's skill or judgment to select finish goods for any purpose and that there are no warranties which are not contained in this agreement.

In no event shall Hagie Manufacturing Company's tort, contract, or warranty liability exceed the purchase price of the product. The foregoing limitation will not apply to claims for personal injury caused solely by Hagie Manufacturing Company's negligence.

Hagie Manufacturing Company shall not be liable for damages, including special, incidental or consequential damages or injuries (damage and repairs of equipment itself, loss of profits, rental or substitute equipment, loss of good will, etc.) arising out of or in connection with performance of the equipment or its use by customer, and Hagie Manufacturing Company shall not be liable for any special, incidental or consequential damages arising out of or in connection with Hagie Manufacturing Company's failure to perform its obligation hereunder. HAGIE MANUFACTURING COMPANY'S ENTIRE LIABILITY AND THE CUSTOMER'S EXCLUSIVE REMEDY SHALL BE REPAIR OR REPLACEMENT OF PARTS COVERED UNDER THIS WARRANTY. THIS WARRANTY IN LIEU OF ALL OTHER WARRANTIES, EXPRESSED OR IMPLIED, INCLUDING, BUT NOT LIMITED TO THE IMPLIED WARRANTY OF MERCHANTABILITY OR FITNESS FOR A PARTICULAR PURPOSE.

INDEX

	PAGE	PAGE
A		
ACE: Automatically Controlled Engine	38	
Agitation	64	
Switch	26	
Air Conditioning System		
Belt	126	
Charging System	117	
Climate Controls	30	
Vents	31	
Air Dryer Cartridge	131	
Air Pressure	131	
Air Bag Suspension	131	
Tire Pressure	131	
Air Ride Seat	34	
Air Tank	131	
Airbags	131	
All Up/Hold Switch	24,27,79,102	
Antifreeze	116	
Auxiliary Hydraulic System	39	
Specifications	18	
B		
Batteries	124	
Charging Auxiliary Posts	124	
Disconnect	36	
Service Access	124	
Belts	126	
Engine	126	
Removal	126	
Inspection	126	
A/C Compressor	126	
Bolt Torque	127-128	
Bearing Torque on Hydraulic Tread Adjust	128	
Wheel Bolts	127	
Bottom Parameter, Tasselrol®	96	
Boom		
Boom Extension Switch	26	
Boom L.E.D. Indicators	67	
Boom Solution Valve Switch	26,67	
Configuring 80' to 90'	48	
Cradling	105	
Operation	43-48	
Stands	55	
Buddy Seat	34	
C		
Cab	21-34	
Filters	121	
Charcoal Filter	121	
Fresh Air Intake Filter	121	
Front Console	21-23	
Hazard/ Warning Lights	21	
Highway Lights/ Running Lights	22	
Ignition Switch	23	
Steering Column Release Pedal	23	
Tilt Adjust Handle	23	
Turn Signals	22	
Side Console	24-27	
Agitation Switch	26	
Boom Extension Switch	26	
Boom Valve Section Switch	26	
Fence Row Switch	26	
Float Switch	26	
Foamer Switch	27	
Forward Control	27	
Horizontal Fold	27	
Hydrostatic Lever	25	
Level	27	
Lift	27	
Main Control Switch	27	
Neutral Control	27	
Parking Brake	25	
Power Ports	27	
Reverse Control	27	
Rinse Switch	26	
Speed Control	25,38	
Tank Switch	26	
Throttle Switch	25	
Tread Adjust Switch	26	
Work Mode Switch	26	
Other Features	32-34	
Air Ride Seat	34	
Buddy Seat	34	
Cab Filters	33	
Cab Glass	33	
Interior Lights	32	
Rear Viewing Mirrors	33	
Res-Q-Me Tool/ Emergency Exit	33	
Overhead Controls and Monitors	28-31	
Climate Controls	30	
Detasseling Switch Panel	31	
Field Lights and Work Lights	30	
Hagie Diagnostic Port	28	
MDM	29	
Radio	31	
Raven Spray Systems Console	31	
Tasselrol® Control Box	31	
Spray System Indicator Light	29	
Vents	31	
Warning Indicator Light	28	
Windshield Wiper and Washer Fluid Switches	29	
Specifications	17	
Calibration	80-90	
Programming Raven Console	82-90	
Circuit Breakers	125	
Combo Attachment	74	
Combo Control Panel	74,79	
Cooling System		
Coolant	116	
Radiator Grille Screen	119	
Cutter Head Assembly	49,76	

INDEX

	PAGE	PAGE
D		
Decals		
Location	5-9	
Depth Command	52	
Detasseling		
Heads	50	
Switch Panel	31	
E		
Electrical System	124-125	
Batteries	124	
Charging Auxiliary Posts	124	
Service Access	124	
Circuit Breakers	125	
Specifications	15-17	
Circuit Breakers/Fuses	15-17	
General Electric System	15-16	
Lights	16-17	
Electro-hydraulic Lift Control Valve	49	
Emergency Exit (Res-Q-Me Tool)	33	
Engine	35	
Air Intake Filter	118	
Drive Belt	126	
Fuel	117	
In Line Strainer	120	
Primary Fuel Filter	120	
Remote Fuel Filter	120	
Oil	114	
Filter	120	
Operation	36-38	
Specifications	14	
F		
Fence Row		
L.E.D. Indicator	68	
Operation	68	
Switch	26	
Filter Minder®	118	
Filters	118-121	
Engine Air Intake Filter	118	
Engine Oil Filter	120	
Filter Minder®	118	
Fresh Air Cab Filters	121	
Fuel Filters	120	
Hydraulic High-Pressure In-Line Filter	119	
Hydraulic Suction Filters	119	
Rinse Strainer	121	
Solution Line Strainer	121	
Radiator Grille Screen	119	
Float Switch	26	
Flow Meter	64	
Fluids	114-117	
Air Conditioning Charge	117	
Capacities	17, 117	
Cooling System Coolant	116	
Engine Oil	114	
Fuel	117	
Hydraulic Oil	114	
Wheel Hub Oil	115	
Windshield Washer	116	
Foam Marking System	70-71	
Adjusting System Pressure	70	
Filling the Foam Marker System	71	
Operation	70	
Specifications	18	
Switch	27	
System Pressure Gauge	70	
Foamer Switch	27	
Folding Outriggers	105	
Forward Control	27	
Fresh Air Cab Filters	121	
Front Console	21-23	
Hazard/ Warning Lights	21	
Highway Lights/ Running Lights	22	
Ignition Switch	23	
Steering Column Release Pedal	23	
Tilt Adjust Handle	23	
Turn Signals	22	
Fuel	117	
Filter	120	
In Line Strainer	120	
Fuel Filter (water separator)	120	
Remote Fuel Filter	120	
Fuses	125	
G		
Glass (cab)	33	
Grease Zerks	122-123	
H		
Hagie Diagnostic Port	28	
Hagie Tasselrol®/LS System		
Initial Set Up	91-95	
Parameters	96-104	
Bottom Parameter	99	
Response Parameter	97	
Top Parameter	98	
Hand Washing System	68	
Hazard/ Warning Lights	21	
Highway Lights/ Running Lights	22	
Horizontal Boom Fold	27, 46	
Hydraulic Outrigger Fold Valve	49	
Hydraulic Pump	40	
Oil Level	114	
Oil Type	114	
Hydraulic System	39-52	
Auxiliary	18, 39	
Detasseling System	49-52	
Depth Command	52	
Detasseling Heads	50	
Electro-Hydraulic Lift Control Valve	51	
Motor Control Valve	50	
Outrigger Fold Valve	51	

INDEX

	PAGE		PAGE
Relief Manifold	51		
Hydraulic Pumps	40		
Hydraulic Tread Adjust	41		
Ladder	40		
Power Steering System	40		
Spray System	42-48		
Boom Control Valve	42		
Horizontal Boom Fold	46		
Level	45		
Lift	44		
Manually Folding Boom	48		
Solution Pump	42		
Spray Booms	43		
Vertical Extension Fold	47		
Hydraulic Tread Adjust	41		
Hydrostatic Drive System	35-38		
ACE: Automatically Controlled Engine	38		
Battery Disconnect	36		
Cummins Engine	35		
Operating the Engine	36-38		
Over-ride	73		
Parking Brake	38		
Pre-operational Checks	36		
Specifications	18		
Speed Control	25,38		
Starting the Engine	38		
Tandem Pump	35		
Wheel hubs	35		
Wheel Motors	35		
Hydrostatic Lever	25		
All Up/Hold	27		
Foamer Switch	27		
Forward Control	27		
Horizontal Fold	27		
Level ..	27		
Lift ..	27		
Main Solution Control	27		
Neutral Position	27		
Reverse Control	27		
Throttle Switch	25		
I			
Identification numbers	12-13		
Engine	12		
Front Wheel Motors	13		
Hydrostatic Pumps	13		
Rear Wheel Motors	13		
Sprayer	12		
Wheel Hubs	13		
Ignition Switch	23		
Inductor Operation	66		
Interior Lights	32		
J,K			
		L	
Ladder			40
Lubrication			122
L.E.D. Indicators			
Boom Solution Valve			67
Fence Row Nozzle			68
Level			27, 45
Lift			27, 44
Lift Arm Assemblies			
Lubrication			123
Lift Cylinders (detasseling)			49
Lights			
Field Lights			30
Hazard/Warning Lights			21
Highway Lights			22
Running Lights			22
Turn Signal			22
Work Lights			30
Limited Warranty			153
Lock Assembly			56
LS System/ Depth Command			74, 75
LS Photo-light Sensors			78
Lubrication			122-123
Grease Zerks			122
Ladder			122
Legs and Steering			122
Transom Pivot Tubes			122
Lug Nuts			127
M			
Main Control Switch			27, 67
Maintenance Schedule			109-113
Manual Fold (90' to 80')			48
MDM			29
Motor Control Valve			49
N			
Neutral Position			27
Nozzle Diaphragms			132
O			
Operating the Engine			36
ACE: Automatically Controlled Engine			38
Battery Disconnect			36
Parking Brake			38
Pre-operational Checks			36
Speed jControl			25,38
Starting the Engine			38
Operating Information			21-79
Cab			21-34
Air Ride Seat			34
Agitation Switch			26
All Up/Hold			27
Boom Extension Switch			26
Boom Valve Section Switch			26
Buddy Seat			34

INDEX

	PAGE		PAGE
Cab Filters	33	ACE: Automatically Controlled Engine	38
Cab Glass	33	Battery Disconnect	36
Climate Controls	30	Cummins Engine and Tandem Pump.....	35
Detasseling Switch Panel.....	31	Parking Brake	38
Fence Row Switch	26	Pre-operational Checks.....	36
Field Lights	30	Speed Control	25,38
Float Switch	26	Starting the Engine	38
Foamer Switch	27	Wheel Motors and Hubs.....	35
Forward Control	27	Quick Attach System.....	53-60
Hagie Diagnostoc Port	28	Detaching	53-57
Hazard/Warning Lights.....	21	Reconnecting.....	58-60
Highway Lights/Running Lights	22	Spray System	61-71
Horizontal Fold Control	27	Agitation	64
Hydrostatic Lever	25	Boom Section L.E.D. Indicators.....	67
Ignition Switch.....	23	Boom Solution Valve Switches.....	67
Interior Lights	32	Fence Row Applicator	68
Level Control.....	27	Filling the Foam Marker System.....	71
Lift Control	27	Flow Meter	64
Main Control Switch	27	Foamer Operation.....	70
MDM.....	29	Hand Washing System.....	68
Neutral Control.....	27	Inductor Operation	66
Parking Brake	25	Instructions	61
Power Ports	27	Main Control Switch	67
Radio	31	Rinse System Operation	69
Raven Spray System Console	31	Solution Pressure Gauge	64
Rear Viewing Mirrors	33	Solution Pump	63
Res-Q-Me Tool/Emergency Exit.....	33	Solution Quick Fill	65
Rinse Switch.....	26	Solution Tank.....	63
Reverse Control.....	27	Solution Tank Valve	63
Speed Control.....	25,38	Outrigger Fold Valve.....	51
Spray System Indicator Light	29	Folding Outriggers	105
Steering Column Release Pedal	23	Lubrication	123
Tank Switch	26	Overhead Controls and Monitors.....	28-31
Tasselrol® Control Box	31	Climate Controls	30
Throttle Switch	25	Detasseling Switch Panel.....	31
Tilt Adjust Handle.....	23	Field Lights and Work Lights	30
Tread Adjust Switches	26	Hagie Diagnostic Port	28
Turn Signals.....	22	MDM.....	29
Vents	31	Radio	31
Warning Indicator Light	28	Raven Spray Systems Console.....	31
Washer Fluid Switch	29	Spray System Indicator Light	29
Windshield Wiper Switch.....	29	Tasselrol® Control Box	31
Work Lights.....	30	Vents	31
Work Mode Switch.....	26	Warning Indicator Light	28
Hydraulic System	39-48	Windshield Wiper and Washer Fluid Switches	29
Auxiliary Hydraulic System.....	39	Over-ride	73
Horizontal Boom Fold	46		
Hydraulic Pump	40	P	
Hydraulic Tread Adjust.....	41	Parameters, Tasselrol®.....	96-99
Ladder	39	Bottom Parameter.....	99
Manually Folding Boom.....	48	Response Parameter	97
Level.....	45	Top Parameter	98
Lift	44	Parking Brake.....	25,38
Power Steering System.....	40	Photo-Light Sensor.....	74
Solution Pump	42	Power Ports	27
Spray Booms	43	Power Steering.....	40
Vertical extension Fold.....	47	Power Train	
Hydrostatic Drive System.....	35-38		

INDEX

	PAGE		PAGE
Specifications.....	14	Solution Tank	63
Pre-operational Checks	36	Solution Tank Valve	63
Pressure Gauges		Specifications	14-20
Foamer System Air Pressure.....	70	Auxiliary Hydraulic System.....	18
Solution Spray System Pressure.....	64	Cab and Instruments.....	17
Puller Heads	74	Capacities.....	17
		Detasseling Equipment Options.....	19
		Electrical System.....	15-17
Q		Circuit Breaker and Fuses.....	15-17
Quad Puller Assembly	49,75	General Electrical System.....	15
Lubrication.....	123	Lights.....	16-17
Quick Attach System	53-60	Other Fuses and Relays.....	15-16
Detaching.....	53-57	Engine.....	14
Reconnecting.....	58-60	Foam Marking System.....	18
Quick Fill, Solution	66	General Sprayer Information.....	14
		Power Train.....	14
		Brakes.....	14
R		Drive.....	14
Radiator Grille Screen	119	Steering System.....	14
Raven Console	31, 69	Rinse System.....	18
Calibration.....	80-90	Spray System.....	18
Rear Viewing Mirrors	33	Booms.....	18
Relief Manifold	49	General Spray System.....	18
Response Parameter, Tasselrol®	97	Solution Fill Connection.....	18
Res-Q-Me Tool/Emergency Exit	33	Solution Tank.....	18
Reverse Control	27	Tires.....	20
Rinse Switch	26	Spray Booms	43
Rinse System	69	Configuring 80' to 90'.....	48
Rinse Switch.....	26	Cradling.....	105
Specifications.....	18	Operation.....	48
		Spray System	61-71
S		Agitation.....	64
Safety Precautions	1-4	Boom L.E.D. Indicators.....	67
Chemical Handling Safety.....	4	Boom Solution Valve Switches.....	67
Driving Safety.....	1	Fence Row Applicator.....	68
General Safety.....	4	Flow Meter.....	64
Operating Safety.....	2	Foamer Operation.....	70
Repair/Maintenance Safety.....	3	Filling the Foam Marking System.....	71
Seat		Hand Washing System.....	68
Air Ride Seat.....	34	Inductor Operation.....	66
Buddy Seat.....	34	Instructions of Operation.....	61
Serial Number Location		Introduction.....	61
Engine.....	12	Main Control Switch.....	67
Hydrostatic Pumps.....	13	Rinse System.....	69
Sprayer.....	12	Solution Pressure Gauge.....	64
Wheel hubs		Solution Pump.....	63
Front.....	13	Solution Quick Fill.....	65
Rear.....	13	Solution Tank.....	63
Wheel motors		Solution Tank Valve.....	63
Front.....	13	Specifications.....	18
Rear.....	13	Spray Tips	132
Service/Maintenance	109-132	Speed Control	25,38
Service Point Quick Reference.....	109	Starting the Engine	38
Intervals.....	110-113	Steering Column Release Pedal	23
Short Corn Operation	101	Storage	133-134
Solution Line Strainer	121	Suspension	131
Solution Pressure Gauge	64	Air Bag Pressure.....	131
Solution Pump	42, 63	Lubrication.....	122
Solution Quick Fill	65		

INDEX

	PAGE	PAGE
T		
Table of Contents	iii	
Tandem Pumps	35	
Tank Switch	26	
Tasselrol® Control Box	31,79	
Display Screen Quick Reference Chart	103-104	
Initial Set-up	91-95	
Dwell/Valve Compensation	93	
Lifts	93	
Lift Offsets		
Lift Down Offset	95	
Lift Up Offset	94	
Lift Speeds		
Lift Down Speed	95	
Lift Up Speed	94	
Machine Valve Type	92	
Parameter Mode	91	
Throttle Control	25	
Tilt Adjust Handle	23	
Tires		
Air Pressure	131	
Filling	131	
Mounting	131	
Specifications	20	
Toe-In	129-130	
Adjusting	130	
Checking	129	
Top Parameter, Tasselrol®	98	
Torque Values		
Tread Adjust Bearing	128	
Wheel Lug Nuts	127	
Transom Pivot Tubes	122	
Lubrication	122	
Transporting Sprayer	105-108	
Cradling the Booms	105	
Driving	106	
Trailerling	107-108	
Tread Adjust Switch	26	
Tread Adjust Bearing Torque	128	
Tread Width		
Adjusting	41	
Tread Adjust Switch	26	
Indicators	41	
Trouble Shooting Guide	135-151	
Electrical	143	
Engine	135-136	
Hagie Tasselrol®/LS System		
Display	148-150	
Electrical	146-147	
Hydraulic	144-145	
Wire Diagram	151	
Hydraulic System	141-142	
Hydrostatic System	139-140	
Notes	152	
Spray System	137-138	
Turn Signals		
		22
U,V		
Vertical Extension Fold		47
W		
Warning Symbol Definitions		ii
Warranty		153
Wet Tank		131
Wheel Lug Nuts		127
Wheel Hubs		35
Maintenance		
Oil		114
Torque Value		127
Specifications		14
Wheel Motors		35
Specifications		14
Windshield Washer/Wiper		29
Fluid		116
X,Y,Z		

NOTES