

CALIFORNIA

Proposition 65 Warning

WARNING: Diesel engine exhaust and some of its constituents are known to the State of California to cause cancer and birth defects or other reproductive harm.

WARNING: Battery posts, terminals, and related accessories contain lead and lead compounds, chemicals known to the State of California to cause cancer and birth defects or other reproductive harm.



ANY PICTURES CONTAINED WITHIN THIS OPERATOR'S MANUAL THAT DEPICT SITUATIONS WITH SHIELDS, GUARDS, RAILS, OR LIDS REMOVED ARE FOR DEMONSTRATION PURPOSES ONLY. HAGIE MANUFACTURING COMPANY STRONGLY URGES THE OPERATOR TO KEEP ALL SHIELDS AND SAFETY DEVICES IN PLACE AT ALL TIMES.



**OPERATOR'S MANUAL
FOR
HAGIE MODEL STS 10T HI-TRACTOR**

HAGIE MANUFACTURING COMPANY

721 CENTRAL AVENUE WEST
BOX 273
CLARION, IOWA 50525-0273

(515) 532-2861

COVERS MACHINE SERIAL NUMBERS:U16T0990001 thru U16T1111100

01-11 493445

© 2008 Hagie Manufacturing Company. Clarion, Iowa USA

ABBREVIATIONS

A/C	AIR CONDITIONING	MAINT.....	MAINTENANCE
ACCUM	ACCUMULATOR	MIN	MINUTE
ADJ	ADJUST	M/F.....	MAINFRAME
ADPTR	ADAPTER	MPH.....	MILES PER HOUR
ALT.....	ALTERNATOR	MT.....	MOUNT
AMP	AMPERE	MTH.....	MONTH
APPROX	APPROXIMATELY	MTR.....	MOTOR
ASSY.....	ASSEMBLY	NO	NUMBER
AUX.....	AUXILIARY	OD	OUTSIDE DIAMETER
BRKT.....	BRACKET	POLY	POLYETHYLENE
BTTRY.....	BATTERY	PRESS.....	PRESSURE
C.....	CELSIUS	PRKNG.....	PARKING
CAL	CALIBRATION	PSI.....	POUNDS PER SQUARE INCH
CCA.....	COLD CRANKING AMPS	QT.....	QUART
CHEM.....	CHEMICAL	RAD	RADIATOR
cm	CENTIMETER	REC.....	RECOMMENDED
CYL	CYLINDER	REQ.....	REQUIRED
DIA	DIAGRAM	RPM.....	REVOLUTIONS PER MINUTE
DISPL.....	DISPLACEMENT	SEC	SECOND
EA	EACH	SERV.....	SERVICE
ELECT.....	ELECTRIC	SMV.....	SLOW MOVING VEHICLE
F	FAHRENHEIT	SOLE	SOLENOID
FIG.....	FIGURE	SOLU.....	SOLUTION
FRT	FRONT	SPEC.....	SPECIFICATION
FT.....	FOOT OR FEET	STRG.....	STEERING
GA	GAUGE	SQ.....	SQUARE
GAL	GALLON	TACH.....	TACHOMETER
GPA.....	GALLONS PER ACRE	TEMP.....	TEMPERATURE
GPM.....	GALLONS PER MINUTE	TERM.....	TERMINAL
GPS.....	GLOBAL POSITIONING SATELLITE	TRD	TREAD
HAL	HALOGEN	TT	TUBE-TYPE
HR	HOOR	TU	TUBELESS
HYD.....	HYDRAULIC	VAR	VARIABLE
HYDRO	HYDROSTATIC	V	VOLT
ID.....	INSIDE DIAMETER	VFC.....	VARIABLE FLOW CONTROL
IN.....	INCH	VLV	VALVE
INFO.....	INFORMATION	W/	WITH
Km/H	KILOMETERS PER HOUR	W/O.....	WITHOUT
L	LITER (DISPLACEMENT)	W	WEIGHT
l	LITER (LIQUID)	WD.....	WHEEL DRIVE
LB.....	POUND	WHL.....	WHEEL
m	METER	WK.....	WEEK

TO THE OWNER



A WORD FROM HAGIE MANUFACTURING COMPANY

Congratulations on your selection of a Hagie Model STS 10T sprayer. We recommend that you study this Operator's Manual and become acquainted with the adjustments and operating procedures before attempting to operate your new sprayer. As with any piece of equipment, certain operating procedures, service, and maintenance are required to keep it in top running condition.

We have attempted herein to cover all of the adjustments required to fit varying conditions. However, there may be times when special care must be considered.

Hagie Manufacturing Company reserves the right to make changes in the design and material of any subsequent sprayer without obligation to existing units.

We thank you for choosing a Hagie sprayer and assure you of our continued interest in its satisfactory operation for you. If we might be of assistance to you, please call us.

We are proud to have you as a customer.



TO THE OPERATOR

The following pages and illustrations will help you operate and service your new sprayer. It is the responsibility of the user to read the Operator's Manual and comply with the safe correct operating procedures and lubricate and maintain the product according to the maintenance schedule.

The user is responsible for inspecting the machine and having parts repaired or replaced when continued use of the product causes damage

or excessive wear to other parts.

Keep this manual in a convenient place for easy reference when problems arise. This manual is considered a permanent fixture with this machine. In the event of resale, this manual should accompany the sprayer. If you do not understand any part of the manual or require additional information or service, contact the Hagie Customer Support Department:

Hagie Manufacturing Company
 721 Central Avenue West
 Box 273
 Clarion, IA 50525-0273
 (515) 532-2861

The following symbols, found throughout this manual, alert you to potentially dangerous conditions to the operator, service personnel, or the equipment.



This symbol indicates a hazardous situation which, if not avoided, will result in death or serious injury.



This symbol indicates a potentially hazardous situation which, if not avoided, could result in death or injury.



This symbol indicates a potentially hazardous situation which, if not avoided, may result in minor or moderate injury. It may also be used to alert against unsafe practices.

TABLE OF CONTENTS

I.	SAFETY/DECALS.....	1.1-1.9
II.	SPRAYER IDENTIFICATION.....	2.1-2.2
III.	SPECIFICATIONS	3.1-3.6
IV.	OPERATING INFORMATION.....	4.1-4.32
	CAB	4.1-4.14
	HYDROSTATIC SYSTEM	4.15-4.18
	HYDRAULIC SYSTEM.....	4.19-4.26
	SPRAY SYSTEM	4.27-4.32
V.	TRANSPORTING	5.1-5.4
VI.	SERVICE AND MAINTENANCE.....	6.1-6.23
	SERVICE POINT REFERENCES.....	6.1-6.5
	FLUIDS.....	6.6-6.9
	FILTERS	6.10-6.13
	LUBRICATION.....	6.14
	ELECTRICAL.....	6.15-6.16
	BELTS.....	6.17
	BOLT TORQUES	6.18-6.19
	TOE-IN.....	6.20-6.21
	AIR PRESSURE.....	6.22
	OTHER SYSTEMS	6.23
VII.	STORAGE	7.1-7.2
VIII.	TROUBLE SHOOTING.....	8.1-8.9
IX.	LIMITED WARRANTY.....	9.1

I. SAFETY/DECALS

SAFETY PRECAUTIONS

Most accidents occur as the result of failure to follow simple and fundamental safety rules. For this reason, most accidents can be prevented by recognizing the real cause and doing something about it before the accident occurs.

Many conditions cannot be completely safeguarded against without interfering with efficient operation and/or reasonable accessibility. Therefore, you must study this Operator's Manual

and learn how to use the sprayer controls for safe operation. Likewise, do not let anyone operate without instruction.

Do not make modifications such as weldments, add-ons, adaptations, or changes from the original design of sprayer. Such changes and/or modifications may become safety hazards to you and to others and will void all warranties.

DRIVING

- Before moving sprayer, make sure no persons or obstructions are in path of travel.
- Do not permit passengers on sprayer when it is moving; they may fall off or obstruct operator's view.
- Never drive near ditches, embankments, holes, mounds, or other obstacles.
- Never drive on hills too steep for safe operation.
- Always drive at a reasonable field speed.
- Reduce sprayer's speed before turning.
- Come to a complete stop before reversing direction.
- Pull over to side of road before stopping.
- Additional weight caused from partially full or full solution tanks may cause erratic or increased stopping distance.
- Never operate sprayer on roadway with any solution in solution tank.
- Do not activate parking brake while machine is in motion or damage may occur to sprayer.
- Use flashing/hazard warning lights when traveling on public roads, day or night, unless prohibited by local law.
- Make sure SMV and SIS emblem is in place and visible from rear when traveling on public roads.

I. SAFETY/DECALS

OPERATING

TREAD WIDTH

- Select a tread setting to fit between crop rows.

SPRAYER BOOMS

- Cradle booms when leaving sprayer unattended.
- Make sure booms are folded when cradled.
- Select a safe area before unfolding booms. Avoid power lines and overhead structures.

GENERAL OPERATION SAFETY

- Do not adjust factory engine RPM settings.
- Operate engine at one bump to assure proper charge pressure for brakes to work properly.
- Start engine from operator's seat only. Do not by-pass safety-start switch.
- Never use starting fluid to assist engine start up.
- Never run sprayer engine in a closed building. Proper exhaust ventilation is required.
- If equipped with ground speed sensing radar, do not look directly into radar beam. It emits a very low intensity microwave signal which may cause possible eye damage.

I. SAFETY/DECALS

REPAIR/MAINTENANCE

HYDRAULICS

- Use caution when working with hydraulic fluid under pressure. Escaping hydraulic fluid can have sufficient force to penetrate your skin, causing serious injury. This fluid may also be hot enough to burn.
- Always lower load or relieve hydraulic pressure before repairing a hydraulic oil leak.
- Avoid torching, welding, and soldering near pressurized hydraulic lines.

FUELING

- Always turn engine off and allow it to cool before refueling.
- Do not smoke while refueling.
- Do not fill fuel tank completely. Fuel may expand and run over.

GENERAL REPAIR/MAINTENANCE

- Turn off engine before checking, adjusting, repairing, lubricating, or cleaning any part of sprayer.
- When servicing radiator, let engine cool before removing pressurized cap.
- Disconnect battery ground cable and turn main battery switch off before servicing electrical system or welding on machine.
- When charging battery, connect positive cable to positive terminal and negative cable to negative terminal. Failure to do so may result in an explosion and cause injury. Likewise, avoid battery acid contact with body.

I. SAFETY/DECALS

CHEMICAL HANDLING

- Never allow chemicals to come in contact with skin or eyes. Wear protective clothing or respirators as recommended by chemical manufacturer. Store this clothing outside of the cab so as not to contaminate filtered cab environment. Also, clean your boots to remove soil or other contaminated particles prior to entering cab.
- Never pour chemicals into an empty tank, fill tank half full of water first.
- Follow chemical manufacturer's instructions for mixing chemicals.
- Dispose of empty chemical containers properly.
- Wash spilled chemicals or spray residue from sprayer to prevent corrosion and deterioration.
- Select a safe area to fill, flush, calibrate, and clean sprayer where chemicals will not drift or run off to contaminate people, animals, vegetation, or water supply.
- Never place nozzle tips or other parts to one's lips in an attempt to unclog spray tip.
- Do not spray when wind is in excess of chemical manufacturer's recommended speed.
- Store pesticides in their original containers with label intact. Keep them in a separate, locked building.

GENERAL SAFETY

- Keep a fire extinguisher close at all times.
- Keep all shields in place.
- Keep clear of all moving parts and keep others away when operating.
- Do not wear loose fitting clothing that may be blown or drawn into moving parts.

I. SAFETY/ DECALS

WARNING DECALS

Decals warning you of avoidable danger are located on various parts of the sprayer. They are there for your personal safety and protection. DO NOT remove them. They will fracture upon attempted removal and therefore must be replaced.

Following are locations of important safety decals. Replace them if they are torn or missing. All

warning decals and other instructional Hagie decals or machine striping may be purchased through Hagie Customer Support Department. To replace decals, be sure the installation area is clean and dry; decide on exact position before you remove the backing paper.

DECAL LOCATION



650107

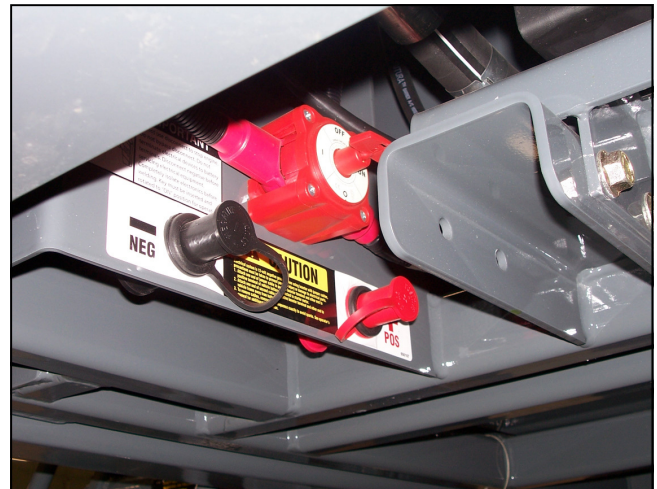

Rear of mainframe above booster terminals.



650118



On engine compartment, in front of air intake.

I. SAFETY/ DECALS



650164

Left side rear cab post.



650165

Right side rear cab post.



650174

In engine compartment, on radiator.



I. SAFETY/ DECALS

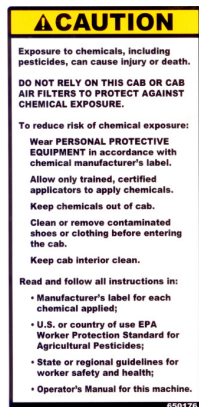

650176

Inside right-hand cab post by rear window.



650178

Quick attach mount.

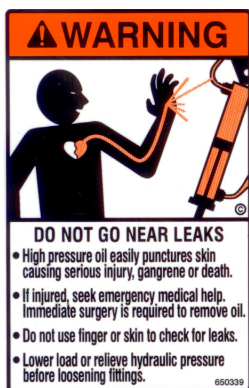

650339

On front cross member, left side (picture 1)

On hydraulic reservoir, to left of sight gauge (picture 2)

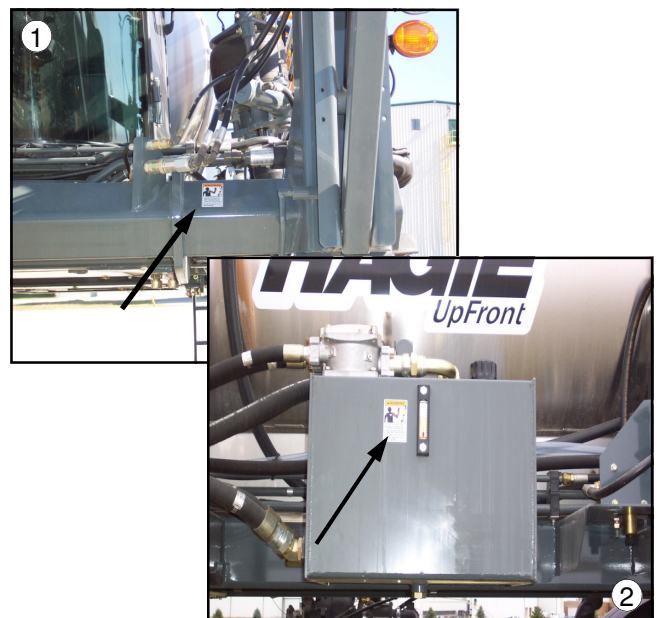

I. SAFETY/ DECALS



650848

On ladder pivot tube.

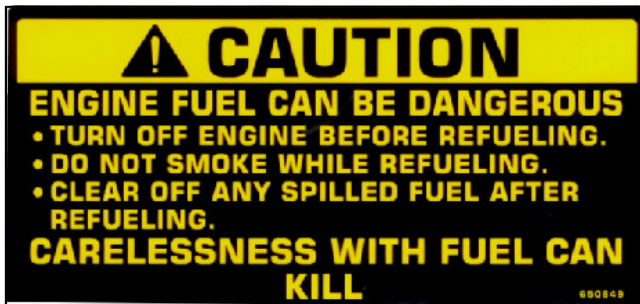
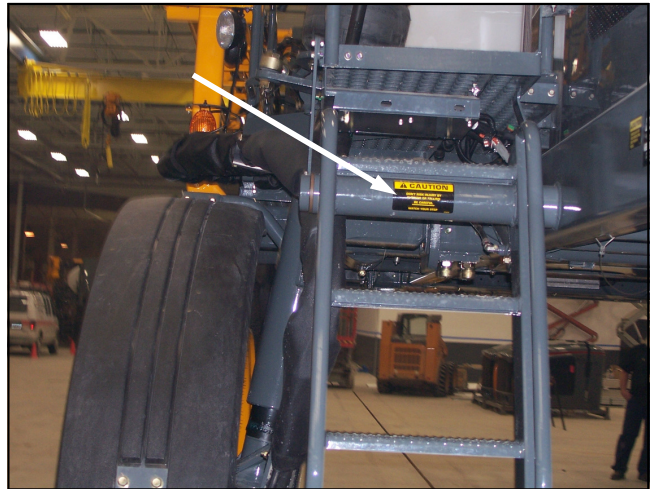

650849

On engine compartment, near fuel cell cap.

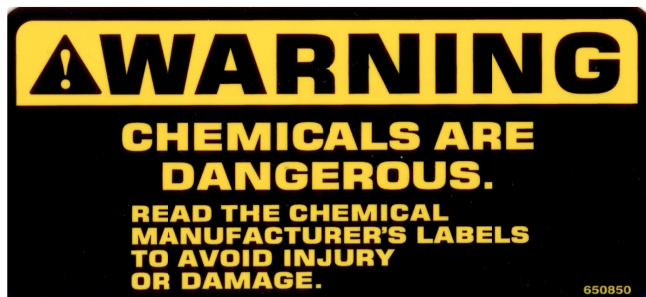

650850

On solution tank, near fill lid



I. SAFETY/ DECALS



Left rear mainframe.

650851

Solution pump- hydraulic motor shield

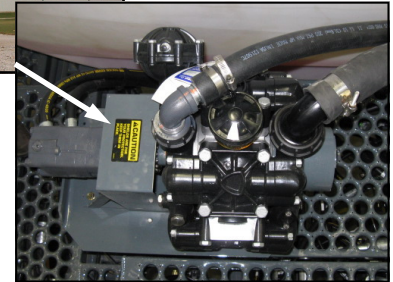

650981

In engine compartment, near radiator cap.

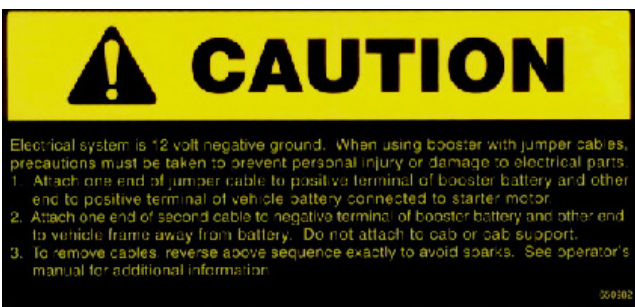

650982

On fuel cell near batteries.



Fuel cell

II. IDENTIFICATION NUMBERS

Each Hagie sprayer is identified by means of a frame serial number. This serial number denotes the model, year in which it was built, and the number of the sprayer. For further identification, the engine has a serial number, the hydrostatic pumps have serial numbers, the wheel motors have identification tags, and the planetary hubs have identifica-

tion plates that describe the type of mount and gear ratio. To ensure prompt, efficient service when ordering parts or requesting service repairs from Hagie Manufacturing Company, record the serial numbers and identification numbers in the spaces provided below.

NOTE:

Reference to left-hand and right-hand used throughout this manual refers to the position when seated in the operator's seat facing forward.

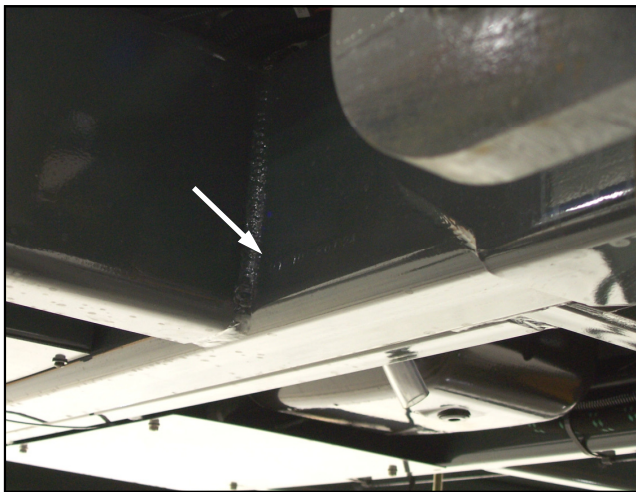

Sprayer

NOTE: Sprayer serial number stamped in the frame on right rear corner.

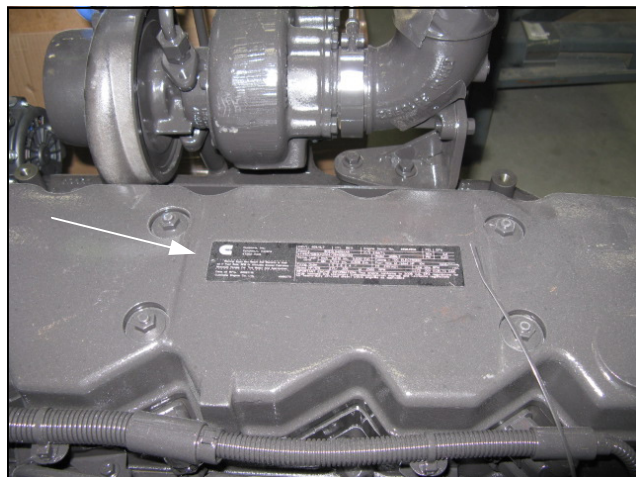

Engine

NOTE: Diesel engine serial number located on gear housing under A/C compressor.

II. IDENTIFICATION NUMBERS



Wheel Hubs

	Left	Right
Front:	_____	_____
Rear:	_____	_____

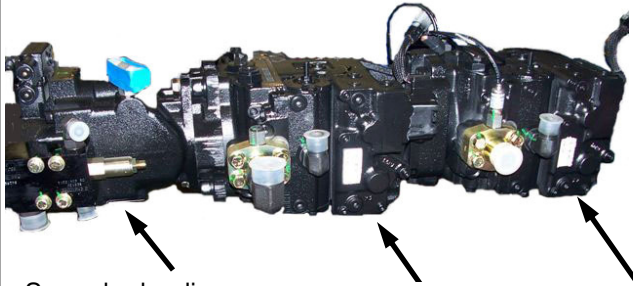

Sauer hydraulic pump Rear Front

Hydrostatic Pumps

Front: _____

Rear: _____

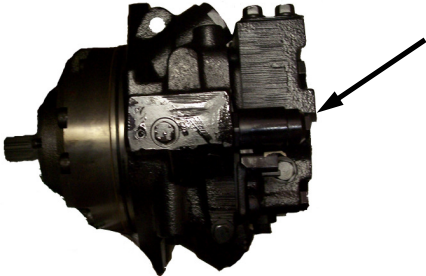

Front Wheel Motors

Left: _____

Right: _____

Refer to parts manual.

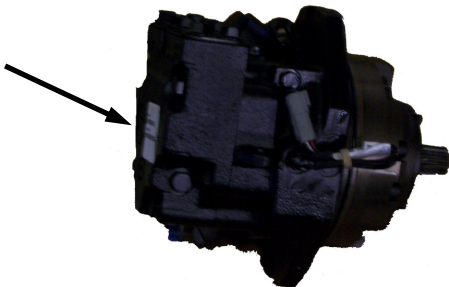

Rear Wheel Motors

Left - w/
Sensor: _____

Right - w/
Sensor: _____

Refer to parts manual.

III. SPECIFICATIONS

A. ENGINE

Manufacturer and model	Cummins
Model.....	QSB6.7-220
Type	Electronic with air to air cooler and turbocharger
Number of cylinders	6
Displacement	6.7 liter (360 c.i.)
Power	215 hp (205 kW), (power bulge to 225hp) (optional 275hp)
Type of fuel.....	Number 1 or number 2 diesel
Fuel system	Filtered, direct-injected
Air cleaner	Dry-type, single element
Engine air filter restriction monitor	Filter Minder [®]
Slow idle	800 RPM
Fast idle.....	2500 RPM (no load)

B. POWER TRAIN

1. Drive

Hydrostatic pump	Sauer-Danfoss (Tandem 90 series)
Displacement.....	150cc (75 X 2) with electronic displacement control
Drive train	All-time four wheel drive
Speed ranges	2
Hydrostatic wheel motors- front and rear	Sauer-Danfoss (90 series)
Final drives	
Type	Planetary gear reduction hubs
- front	Torque Hub [®] (22:1)
- rear.....	Torque Hub [®] (27:1)w/brake
Lubrication.....	Oil bath

2. Brakes (parking only)

Type	Multiple disc Spring applied Hydraulically released
------------	---

3. Steering System

Type	Hydraulic, dedicated circuit
Control.....	Full-time power
Steering cylinders.....	Self-centering, double action

III. SPECIFICATIONS

C. AUXILIARY HYDRAULIC SYSTEM

TypeSingle closed center pump
Pump type.....Load sense

D. SPRAY SYSTEM

1. Booms

Type6ft. Drop nozzles
Standard.....70 ft. (3 spray sections)
Controls.....Electro-hydraulic: fold/lift/level
Level shock absorber.....Gas-charged accumulator

2.Solution Fill Connection

Quick-fill connection2 in. (5.08 cm) I.D.

3.Solution Tank

Standard.....1000 gal. (3785 ℓ) polyethylene w/sight
gauge
Optional.....1000 gal. (3785 ℓ) stainless steel w/sight
gauge
Agitation (polyethylene tank).....Eductor-type w/elect. var. speed control
Agitation (stainless steel tank)Sparge-type w/elect. var. speed control

4.General Spray System

Pump.....Diaphragm - semi-hydraulically driven with
pulse width modulated control valve
Solution valvesElectric ball valves
Pressure gauge.....100 PSI glycerin filled
ConsoleRaven 4600 (GPS-ready)(Spanish)

E. RINSE SYSTEM

Spray system rinse (solution tanks, pump, and booms).....Standard

III. SPECIFICATIONS

G. ELECTRICAL SYSTEM

1. General Electrical System

Battery	Dual 12V, negative ground
Alternator	130 AMP, voltage regulated
Starter	12V with solenoid

2. Circuit Breakers/Fuses

FUSE MODULE 1

MDM Module	3 AMP (1 each)
Input power, control handle, console switch, console lights, field and work lights	5 AMP (4 each)
Ignition, hazard lights, head lights switch, seat air ride, XS-A0 and A1 module power	10 AMP (4 each)
Terminal strip power, HVAC control power, power point 1, wiper/washer, power point 2, XS-A2 module power, Norac (if equipped)	15 AMP (7 each)
Raven console, XT2- A1 module power	20 AMP (2 each)
HVAC fan- high	25 AMP (1 each)

FUSE MODULE 2

Ignition ON	5 AMP (1 each)
Radio, dome light, MDM RTC, diagnostic plug, (spare)	10 AMP (4 each)
Head lights-2 , terminal strip power, agitator/ rinse valves, air dryer, field lights	15 AMP (6 each)
XP2-A0 module power, XT2-A0 module power, XP2-A1, A2 and A3 module power, boom valves	20 AMP (6 each)

RELAY MODULE 1

Head lights-2, reverse, forward, field lights-1 and 2, console light	12V micro relays
--	------------------

III. SPECIFICATIONS

H. CAB AND INSTRUMENTS

1. Cab

General cab	Tilt steering Windshield wiper/washer Dual side mirrors Dome light Tinted glass Training seat
Temperature control	Full-range
A/C charge type	R-134a
Fresh air filtration	Paper and charcoal filter
Seat	Air ride

2. Instruments

MDM	Hour meter Fuel Water temperature Battery voltage Engine oil pressure Ground speed Engine RPM Tread adjustment assist
Stereo	AM/FM/WB with CD

I. CAPACITIES

Solution tank	1000 gallons (3785 ℓ)
Fuel cell	150 gallons (530 ℓ)
Cooling system (including block, lines, & radiator)	18 gallons (68 ℓ)
Hydraulic oil (including tank, lines, filter, & cooler)	55 gallons (208 ℓ)
Rinse system tank	100 gallons (379 ℓ)
Engine oil (including crankcase, lines, filter, & cooler)	17 quarts (16 ℓ)
Wheel hubs	
Fairfield	
Front (2)	84 oz. (2.5 ℓ) each (approx)
Rear (2)	62 oz. (1.8 ℓ) each (approx)

III. SPECIFICATIONS

J. TIRES (front and rear)

TIRE SIZE	TYPE	AIR PRESSURE PSI (kPa)	TREAD WIDTH in. (mm)	LOAD CAPACITY* lbs. (kg)	OVERALL DIAMETER In. (mm)	STATIC LOAD RADIUS** in. (mm)	ROLLING CIRCUM. in. (mm)
STANDARD							
380/85R46	Radial TU	46 (317.16)	15.2 (386.1)	6600 (2993.71)	71.8 (1823.7)	32.9 (835.7)	217.0 (5511.8)

* Load capacity measured at 30 mph (48.28 km/h) unless otherwise specified

** Static load radius is suggested and will vary with load.

IV. OPERATING SYSTEMS

A. CAB

Front Console

- | | |
|---|----------------------------------|
| A. Hazard/ Warning light switch | F. Ignition switch |
| B. Highway lights, running light switch | G. Steering wheel tilt adjust |
| C. Steering Wheel | H. Steering column release pedal |
| D. Turn signal indicator light | |
| E. Turn signal switch | |

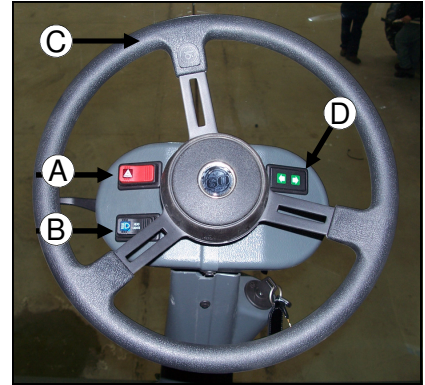

FIG. 4.1-1

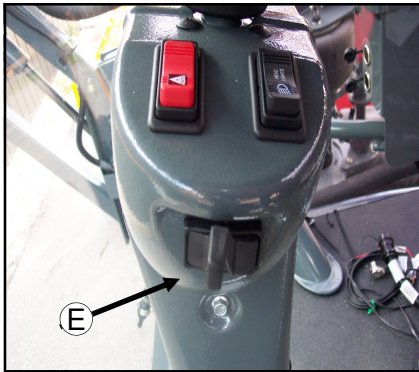

FIG. 4.1-2

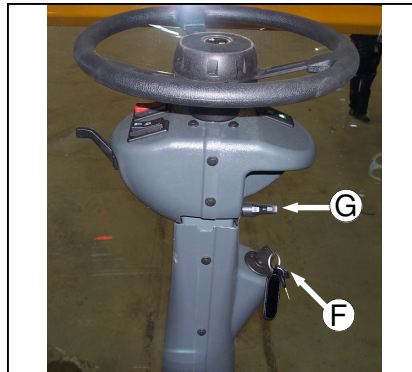

FIG. 4.1-4



FIG. 4.1-3



FIG 4.1-5

HAZARD/ WARNING LIGHTS—To activate the flashing hazard/ warning lights (fig. 4.1-5 and fig. 4.1-6) depress the “FLASHER” switch (fig. 4.1-1, item A). Activate the hazard/ warning lights anytime, day or night, that you are traveling on a public road unless prohibited by law.



FIG. 4.1-6

IV. OPERATING SYSTEMS

A. CAB

HIGHWAY LIGHTS/RUNNING LIGHTS– The highway lights are mounted on the cab and either side of the transom (fig. 4.2-1). Use these trapezoid head lamps when



FIG. 4.2-1



FIG. 4.2-2

traveling on a public road at night. Turn them on using the highway/running light switch located on the front console (fig. 4.2-1, item B).

Activating the highway lights will also turn on the “red” running lights on the rear of the machine (fig. 4.2-2).

The ignition key does not have to be on to operate these lights.



FIG. 4.2-3

TURN SIGNALS– To activate the front turn signals (fig. 4.2-3) and the rear turn signals (fig. 4.2-4 and 5), move the turn signal lever (fig. 4.1-2, item E) forward, away from the operator, to signal a right turn; or back, toward the operator, to signal a left turn. Steering column– mounted turn signal indicators will correspondingly flash when either turn signal is activated. The turn signal switch is not a self-centering switch; you must return it to the “OFF” position by hand after completing your turn.

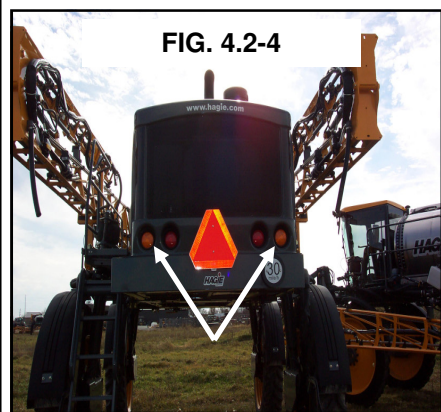

FIG. 4.2-4



FIG. 4.2-5

IV. OPERATING SYSTEMS

A. CAB



FIG. 4.3-1

IGNITION SWITCH– The ignition switch has three positions. The first position is the “OFF” position. The second position is referred to throughout this manual as “ON”, the third position is “START”. To engage the starter, turn the key to the “START” position and hold momentarily until the engine engages. If the engine does not engage after 15 seconds, turn the key to “OFF”. Constant cranking of the starter when an engine fails to engage will cause damage to the battery and the starting system. Refer to OPERATING SYSTEMS section B on hydrostatic drive for more information.

TILT ADJUST HANDLE- The steering wheel tilt adjust handle is for the movement of the upper portion of the steering column only. The steering wheel has infinite position possibilities.

To use the adjustment handle turn it down (toward the operator) to loosen it. You do not need to remove the handle all the way, simply loosen it enough to freely move the steering wheel.

With the handle loosened, push or pull on the steering wheel until it is in a comfortable position. Hold the steering wheel in that position while tightening the adjustment handle. To tighten the adjustment handle turn it upward (away from the operator).



FIG. 4.3-2

NOTE:

Be sure the steering wheel and column are locked in place before trying to move the machine. Failure to do so will make it difficult to maintain control of the machine.

STEERING COLUMN RELEASE PEDAL– The steering column release pedal is for easy exit/ easy entry of the cab. Push the pedal to release the locking gas spring. With the gas spring released, you can smoothly move the entire steering column forward or backward.

To lock the column in place, simply remove your foot from the pedal while holding the column in place. Once the gas spring has locked again, check the column by firmly trying to move the column in both directions.

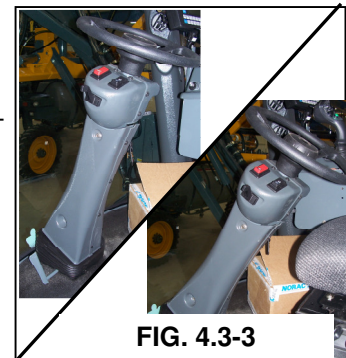

FIG. 4.3-3

IV. OPERATING SYSTEMS

A. CAB

Side Console

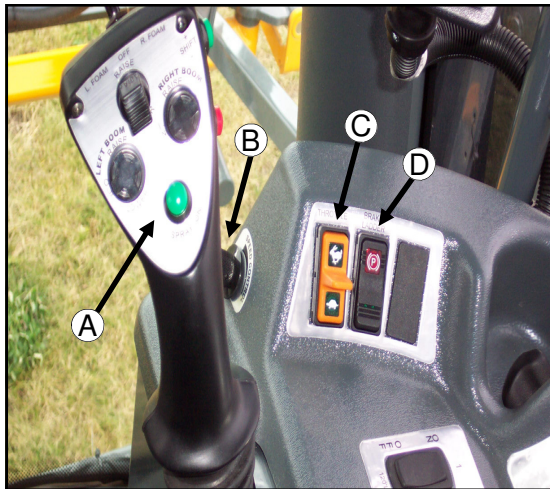

FIG. 4.4-1

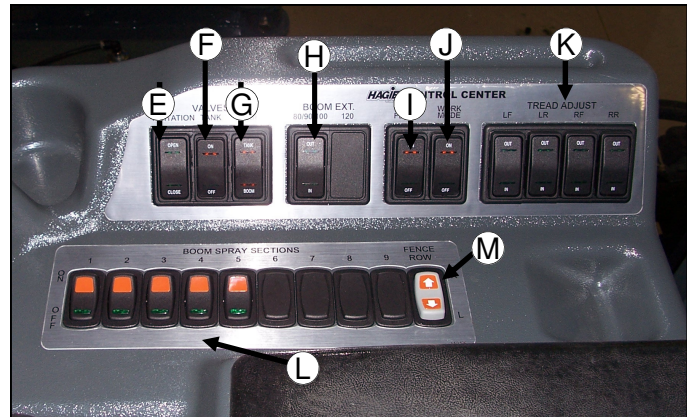

FIG. 4.4-2



FIG. 4.4-4

- A. Hydrostatic Lever
- B. Speed Control
- C. Throttle switch
- D. Brake/Ladder switch
- E. Agitation switch
- F. Solution Tank switch
- G. Rinse Tank switch
- H. Boom Extension switch
- I. Float switch
- J. Work Mode switch
- K. Tread Adjust switches
- L. Boom Spray Section switches
- M. Fence Row Nozzle switch
- N. Power Ports

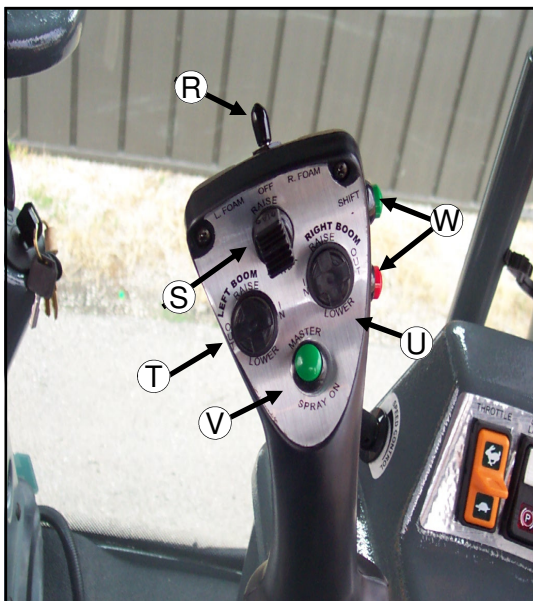

FIG. 4.4-3

- O. Forward
- P. Neutral/Stop
- Q. Reverse
- R. Foamer switch
- S. Hydraulic Lift
- T. Left Boom (level, horizontal fold)
- U. Right Boom (level, horizontal fold)
- V. Master Spray switch "ON"
- W. Speed Range switch

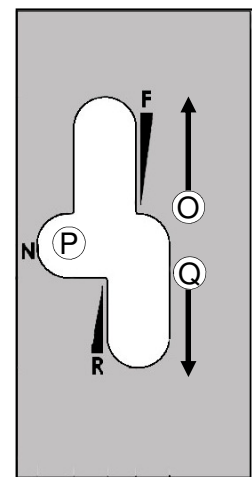

FIG. 4.4-5

IV. OPERATING SYSTEMS



FIG. 4.5-1

HYDROSTATIC LEVER– The hydrostatic lever is used to control the direction of motion of the machine and the speed at which it travels. It is a part of the ACE hydrostatic drive system or the Automatically Controlled Engine Hydrostatic Drive. To learn more about the ACE system, refer to the OPERATING SYSTEMS section B on the hydrostatic drive system.

The lever also houses controls for the spray systems and foam marking systems. For information on these controls, refer to OPERATING SYSTEMS section D on the spray system.

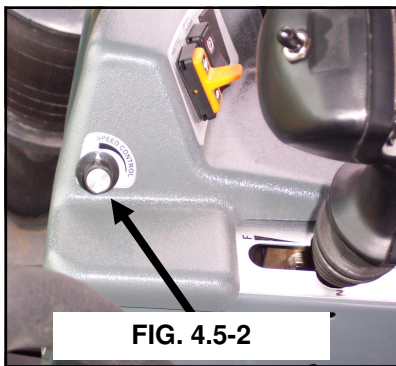

FIG. 4.5-2

SPEED CONTROL- Another feature of the hydrostatic drive system is the speed control. This feature will help regain consistent field speeds when re-entering a field from the end rows.

The speed control will maintain its setting until you reset it. It does not have to be reset each time you turn off the machine.

For information on how to use the speed control feature, refer to OPERATING SYSTEMS section B on the hydrostatic drive system.

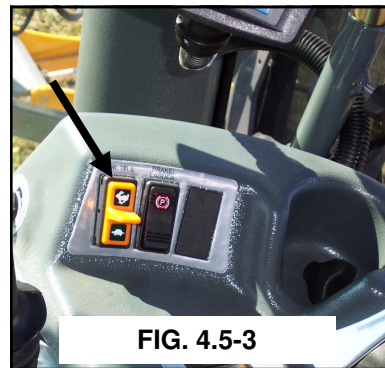

FIG. 4.5-3

THROTTLE SWITCH- The throttle switch (fig. 4.5-3) is used to control engine RPM. There are 2 settings that are controlled by the switch, high and low, with a RPM range of 800 to 2500.

The buttons on the side of the hydrostatic lever (fig. 4.5-4) are to control the speed ranges within the RPM setting. For more information on the throttle controls,

refer to OPERATING SYSTEMS section B on the hydrostatic drive system.



FIG. 4.5-4



FIG. 4.5-5

PARKING BRAKE- The parking brake switch is located next to the throttle switch on the side console. The switch also controls the ladder. The brake switch must be on to lower the ladder and to run the side fill or pressure washer (if equipped).

The parking brake is not intended for normal or emergency stopping and will not engage if machine is moving over 1 mile per hour. Activating the brake while the machine is still moving is hazardous to the operator and the sprayer. Bring the sprayer to a complete stop with the hydrostatic lever in the neutral position before applying the parking brake.

IV. OPERATING SYSTEMS

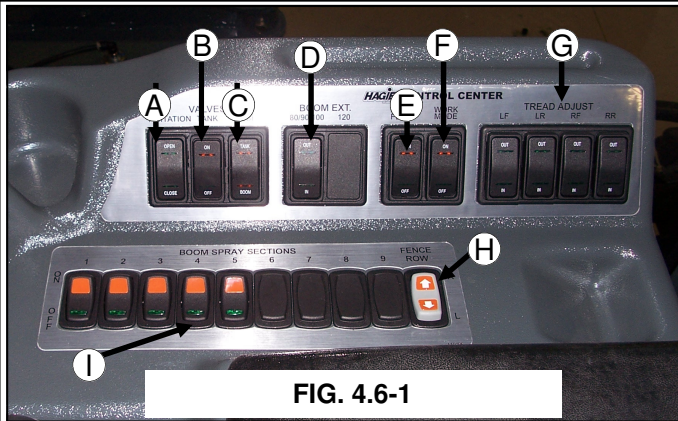

FIG. 4.6-1

AGITATION SWITCH- The agitation switch (fig. 4.6-1, item A) controls the rate of flow through the sparge system. For more information on the agitation system, refer to OPERATING SYSTEMS section D on the Spray Systems.

TANK SWITCH- The tank switch (fig. 4.6-1, item B) controls the solution tank valve. This switch must be on to spray. For more information on the

tank switch, refer to OPERATING SYSTEMS section D on the spray system.

RINSE SWITCH- The rinse switch (fig. 4.6-1, item C) is used when you wish to rinse the solution tank or the booms. For more information on how to use the rinse system, refer to OPERATING SYSTEMS section F on the rinse system.

BOOM EXTENSION SWITCH- Boom extension (fig. 4.6-1, item D) switches are used when folding and unfolding the booms. Refer to OPERATING SYSTEMS section C on spray booms.

FLOAT SWITCH- The float switch is used with the Nitrogen Tool Bar and is not covered in this manual.

WORK MODE SWITCH- The work mode switch (fig. 4.6-1, item F) is a safety switch. There are systems connected to this switch that will not function if the switch is not ON and this switch can not be turned on if certain conditions exist. You can not turn the switch on if the machine is not in neutral. The switch controls the functions of the spray system and the booms. This was set up to protect you, the operator, and others from accidentally engaging the spray system while transporting. Be sure that this switch is on before you intend to engage the spray system.

TREAD ADJUST SWITCH- The tread adjust switches (fig. 4.6-1, item G) are used to hydraulically adjust the tread width. These switches will not do anything if you do not have hydraulic tread adjust. For more information on hydraulic tread adjustment, refer to OPERATING SYSTEMS section C on the hydraulic system.

FENCE ROW SWITCH- The fence row switch (fig. 4.6-1, item H) is for the selection of right or left fence row spray nozzle. More information on the fence row can be found in OPERATING SYSTEMS section D on the spray system.

BOOM SOLUTION VALVE SWITCH- The boom solution valve switches (fig. 4.6-1, item I) each control a valve located on the transom and the booms. The valves control the flow of solution through the boom. The boom is broken down into 5 sections (3 sections on a 60' boom), the far left tip being the beginning of section one. See section D under OPERATING SYSTEMS on the spray system for more information.

IV. OPERATING SYSTEMS

A. CAB



POWER PORTS- On the front of the side console there are two power ports (fig. 4.7-1) for extra equipment to be plugged in. They are each protected by a 15 amp fuse. They are not intended for the permanent connection of extra systems to the sprayer. There is a terminal strip intended for the installation of extra radios and computer equipment. See the SERVICE section E on the electrical components.

FOAMER SWITCH- The foamer switch on the top of the hydrostatic lever (fig. 4.7.2, item A) controls the foam option on either side of the machine. See OPERATING SYSTEM section D for more information on the foamer.

MAIN SOLUTION SWITCH- The main spray control (fig. 4.7-2, item E) in the lower middle of the hydrostatic lever is so the operator can turn all spray valves off at one time.

See OPERATING SYSTEMS section D on spray systems for more information.

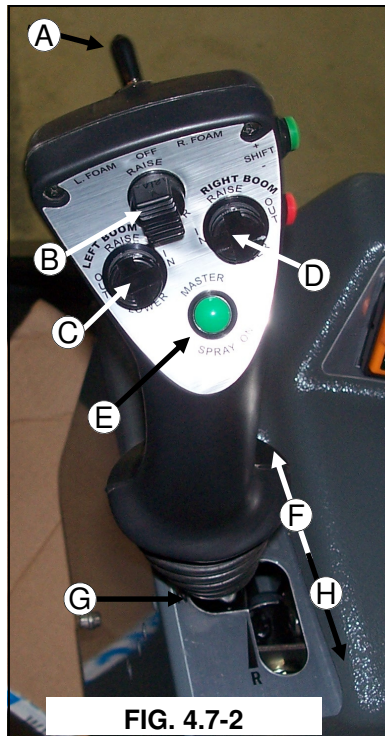

FORWARD CONTROL- The hydrostatic lever is responsible for the direction of motion of the machine. To move forward, slowly move the hydrostatic lever forward. (fig. 4.7-2, item F)

REVERSE CONTROL- To move the machine in reverse, slowly move the hydrostatic lever backward. (fig. 4.7-2, item H) Be sure that the machine is clear of all dangers before putting it in reverse.

NEUTRAL POSITION- The neutral position is also the stop or brake position. (fig. 4.7-2, item G) The neutral position must be met before changing direction of the machine. There are several functions that can not be performed if the machine is not in the neutral position.

More information on the forward, reverse, and neutral positions of the hydrostatic lever is available in section B of the OPERATING SYSTEMS.

LIFT, LEVEL, HORIZONTAL FOLD- (fig. 4.7-2, items B, C, &D) are all a part of the hydraulic system. A complete explanation of their functions can be found in section C of the OPERATING SYSTEMS.

IV. OPERATING SYSTEMS

A. CAB

Overhead Controls and Monitors

- A. Extension Cord
- B. Warning Indicator Light
- C. Spray System Indicator Light
- D. MDM
- E. Wiper switch
- F. Washer Fluid switch
- G. Field Lights switch
- H. Work Lights switch
- I. Climate Control– fan
- J. Climate Control– temp
- K. Raven Console
- L. Radio
- M. Vents

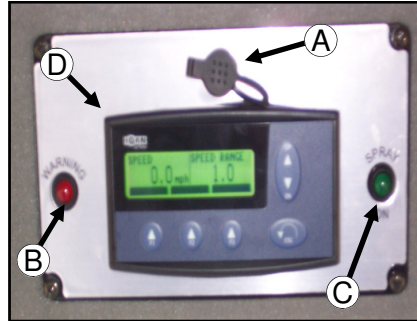

FIG. 4.8-1

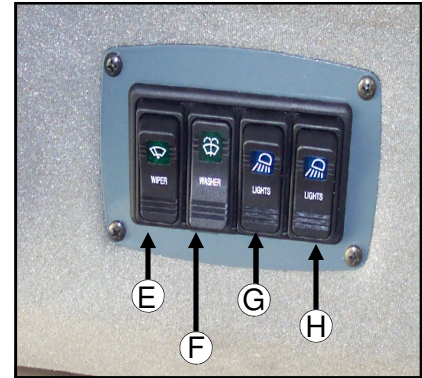

FIG. 4.8-2



FIG. 4.8-3



FIG. 4.8-4



FIG. 4.8-5

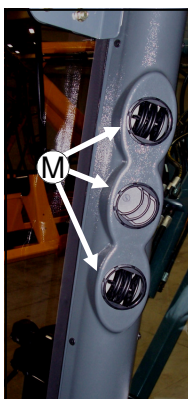

FIG. 4.8-6

HAGIE DIAGNOSTIC PORT– The diagnostic port (fig. 4.8-1, item A) is used for diagnostic purposes only. The Hagie Customer Service department can hook into your system to gather information on faults and malfunctions of the machine. From this port, they would also be able to re-program the machine if it became necessary. This port is not for the use of personal computers or personal digital assistants (PDA's).

The Hagie diagnostic port is protected by a 10 amp fuse.

WARNING INDICATOR LIGHT– The warning indicator light (fig. 4.8-1, item B) will come on if there are any malfunctions or faults in the systems monitored by the MDM. These warnings include, but are not limited to: engine oil pressure, oil level, hydraulic oil level, coolant temperature, battery voltage, and fuel level. An explanation of the fault will appear on the screen. If a fault appears, shut engine off immediately and resolve the fault before continuing. Failure to do so may result in damage to the system with the detected fault.

IV. OPERATING SYSTEMS

A. CAB

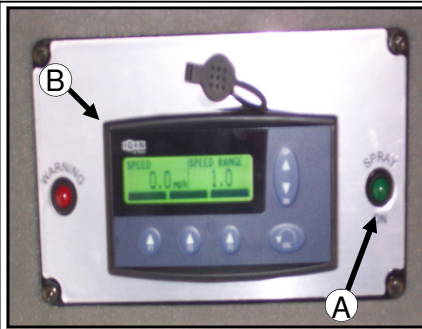

FIG. 4.9-1

SPRAY SYSTEM INDICATOR LIGHT– The spray system indicator light (fig. 4.9-1, item A) will illuminate when the main spray control on the hydrostatic lever (fig. 4.9-2) has been activated. If the light is not on, the spray system is not on.

MDM– The MDM (fig. 4.9-1, item B) is also referred to as the message center. This monitor takes



FIG. 4.9-2

the place of the conventional gauges. This monitor can give you information on tread adjust width, engine RPM, engine oil pressure, hour meter, fuel level, coolant temperature, tire size, battery voltage, speed range, and machine program version. The information can be viewed by using the up and down arrows to move through it. The monitor will also display any faults found in the monitored systems.

WINDSHIELD WIPER AND WASHER FLUID SWITCHES– The windshield wiper switch (fig. 4.9-3, item A) located on the right side of the headliner, turns on the wiper (fig. 4.9-5). The wiper will continue to operate until the switch is returned to the OFF position. Replace the 39 inch wiper blade as necessary.

To activate the washer fluid pump, press the washer fluid switch (fig. 4.9-3, item B) and hold until the desired amount of fluid is dispensed and then release the switch. You must turn the wiper OFF when the washer fluid has been completely wiped away. Washer fluid reservoir is located behind the cab (fig. 4.9-4).

The fluid spray nozzle (fig. 4.9-5, item B) is adjustable. Check the spray pattern and adjust at the beginning of each season or as necessary.

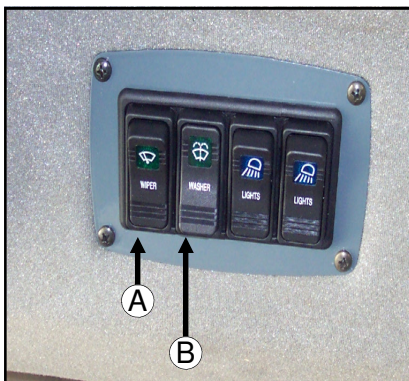

FIG. 4.9-3



FIG. 4.9-4

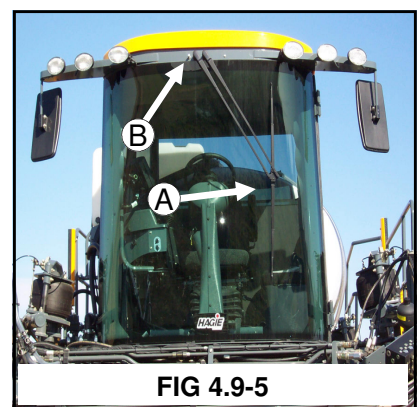

FIG. 4.9-5

IV. OPERATING SYSTEMS

A. CAB

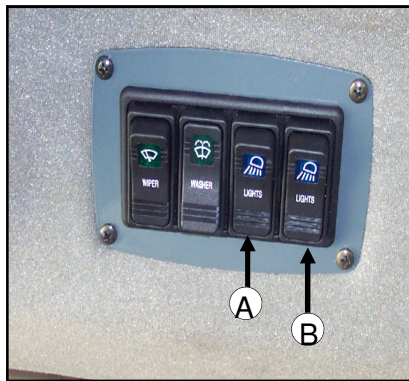

FIG. 4.10-1

FIELD LIGHTS AND WORK LIGHTS—

The field lights (fig. 4.10-2), located on the front of the cab with the headlights, are activated by pushing the switch located on the upper right cab headliner (fig. 4.10-1, item A). Use these lights when operating in the field after dark. Turn them off before entering a public roadway.



FIG. 4.10-2



FIG. 4.10-3

The work lights (fig. 4.10-3), located on each boom cradle, one facing forward and one facing backward, are activated by pressing the other switch located on the right upper cab headliner. These lights can also be used when operating in the field after dark. Turn them off before entering a public roadway.

The ignition key has to be on to operate these sets of lights, but extended use without the engine operating to charge the battery is not recommended.

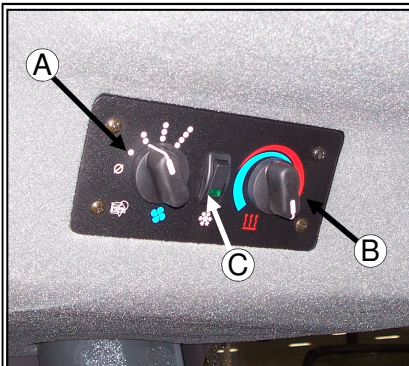

FIG. 4.10-4

CLIMATE CONTROLS -

The climate controls (fig. 4.10-4) are continuous adjusting dial switches located on the front upper cab headliner.

Adjusting Fan Blower Speed— fan blower speed is controlled by the left rotary dial (fig. 4.10-4, item A). To increase the fan speed, rotate the dial clockwise. To reduce the fan speed, rotate the dial counterclockwise. To shut the fan off, rotate the dial all the way counterclockwise.

Adjusting Temperature Setting— forced air temperature adjustments are controlled by the right rotary dial (fig. 4.10-4, item B). Temperature control is a continuously variable adjustment. To increase the forced air temperature, rotate the dial clockwise. To decrease the forced air temperature, rotate the dial counterclockwise.

Operating the Air Conditioning— to activate the air conditioner, press the air conditioning switch (fig. 4.10-4, item C). Adjust fan speed and temperature accordingly. See section B under SERVICE for servicing information.

IV. OPERATING SYSTEMS

A. CAB

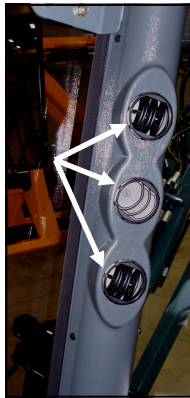

FIG. 4.11-1

VENTS– There are 6 adjustable vents, 3 on each front cab corner post (fig. 4.11-1). They may be adjusted by rotating them for desired direction, or individually turned on or off with the directional fins.

RADIO– The cab has an AM/FM tuner equipped with a CD player and Weather Band broadcasting. Refer to the radio manufacturer’s manual for operating and programming information.



FIG. 4.11-2



FIG. 4.11-3

RAVEN SPRAY SYSTEMS CONSOLE– The spray system is controlled by the Raven SCS 4600 (fig. 4.11-3) and the Pulse Width Modulated Valve (fig. 4.11-4). The system receives data and automatically makes adjustments based on the target rate of application set by the operator.

For detailed information regarding the programming and operating of the Raven console system, please refer to the manufacturer’s installation and operation manual.

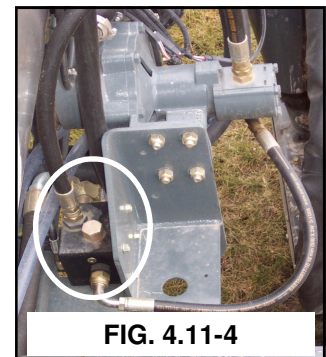

FIG. 4.11-4

IV. OPERATING SYSTEMS

A. CAB

Other Features

- A. Res-Q-Me Tool/ Emergency Exit
- B. Cab Glass
- C. Rear-viewing Mirrors
- D. Buddy Seat
- E. Cab Fresh Air Filters
- F. Interior Lights
- G. Air-Ride Seat



FIG. 4.12-1



FIG. 4.12-2



FIG. 4.12-3



FIG. 4.12-4

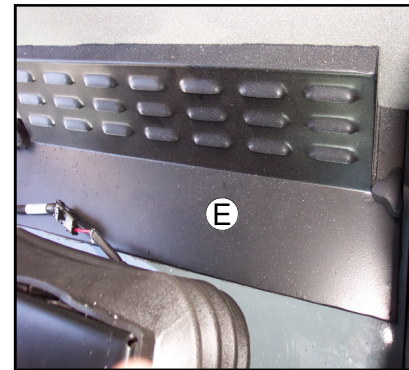

FIG. 4.12-5

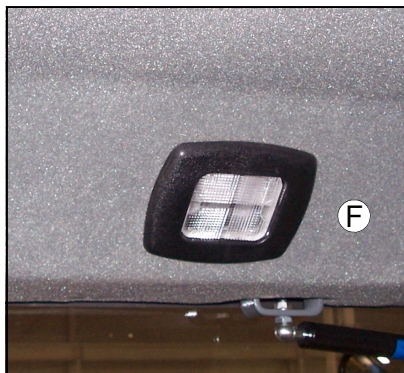

FIG. 4.12-6



FIG. 4.12-7

INTERIOR LIGHTS— The STS10 cab has two interior lights. A dome light that comes on when the door of the cab is opened, and a courtesy light that comes on when the field lights are turned on. (fig. 4.12-6) The courtesy light illuminates the side console. The dome light can also be manually turned on.

IV. OPERATING SYSTEMS

A. CAB



FIG. 4.13-1

RES-Q-ME TOOL/ EMERGENCY EXIT– The RES-Q-ME tool (fig. 4.13-1) located on the right rear cab frame, is used for an emergency exit. The device, when firmly pressed against any glass in the cab, will automatically trigger shattering the glass. Do not look directly at the glass as you use the tool.



FIG. 4.13-2

CAB GLASS– The glass of the cab is DOT approved tempered glass. The front windshield is rounded with a green UV reflective tint and the side and back panels are flat with a UV reflective gray tint.

The design of the cab and the use of the glass allows a 210° view, tip to tip of the booms from the operator's seat.



FIG. 4.13-3

REAR VIEWING MIRRORS– The cab also has two external rear viewing mirrors (fig. 4.13-3).



FIG. 4.13-4

CAB FILTERS– Inside the cab are two filters (fig. 4.13-4), a charcoal filter and a paper filter. Refer to the SERVICE section B on filters for maintenance information. Refer to the Hagie Parts Manual for replacement part information.

IV. OPERATING SYSTEMS



FIG. 4.14-1

BUDDY SEAT– The buddy seat (fig. 4.14-1) was designed as an instructional tool. It is specifically designed for a “co-pilot” to be seated in a good position to be taught how to use the sprayer.

The buddy seat has a hinged seat that lifts to reveal a storage compartment. Do not use the compartment to store chemical soaked clothing or gloves.

AIR RIDE SEAT

- A. **Seat Cushion Adjustment:** Rotate knob to desired cushion position
- B. **Height Adjustment:** Pull knob out to lower seat. Push knob in to raise seat.
- C. **Lateral Isolator:** Lift lever to engage lateral isolator. Push lever down for lock-out.
- D. **Ride Firmness Adjustment:** Rotate knob counterclockwise for firm ride; clockwise for soft ride; and in the middle for an average ride.
- E. **Fore-Aft Adjustment:** Pull lever out and move seat.
- F. **Fore-Aft Isolator:** Lift lever to engage fore-aft isolator. Push lever down for lock-out.
- G. **Backrest Adjustment:** Lift lever to stop and lean rearward or forward to adjust backrest position.
- H. **Armrest Tilt Adjustment:** Turn counterclockwise to lower tilt; clockwise to raise tilt.
- I. **Lumbar Adjustment:** Rotate knob clockwise to increase lumbar support; counterclockwise to decrease support.

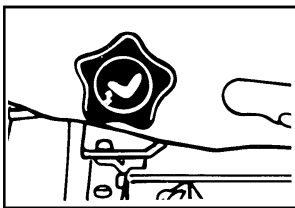

A

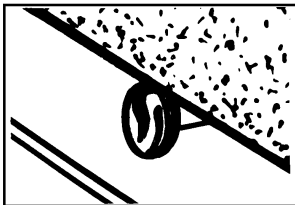

B

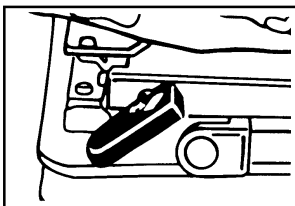

C

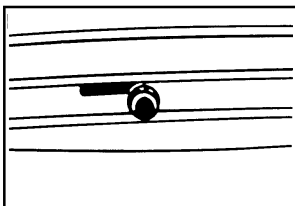

D

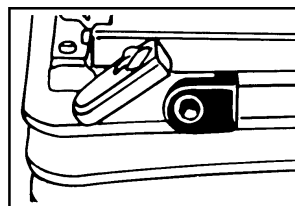

E

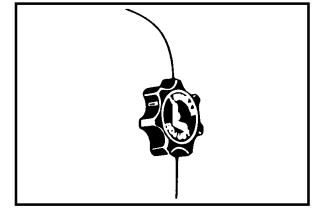

F

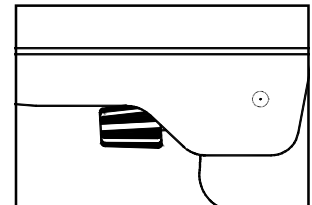

G

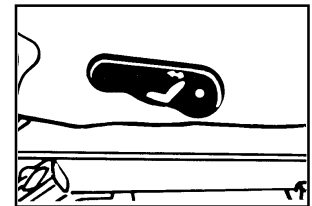

H

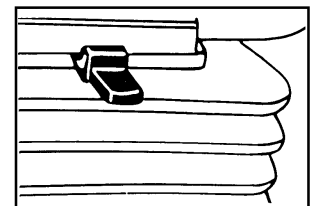

I

IV. OPERATING SYSTEMS

B. HYDROSTATIC DRIVE SYSTEM

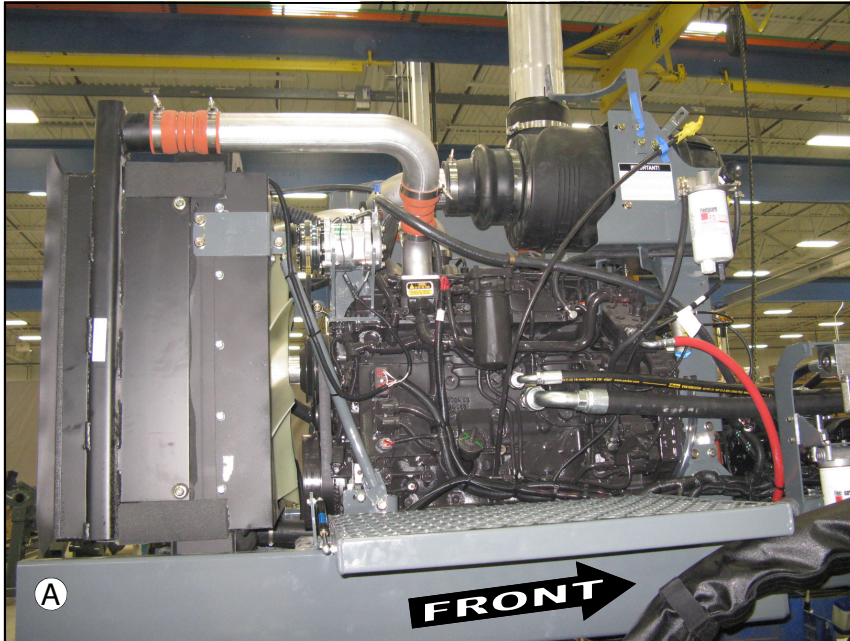

FIG. 4.15-1

- A. Cummins Engine
- B. Tandem Hydrostatic Pumps
- C. Front and Rear Wheel Motors
- D. Wheel Hubs

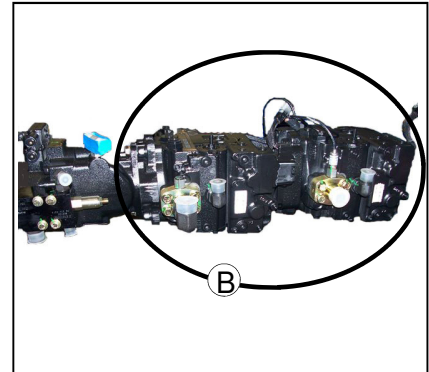

FIG. 4.15-2

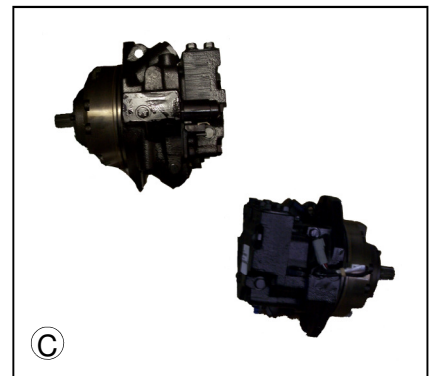

FIG. 4.15-3

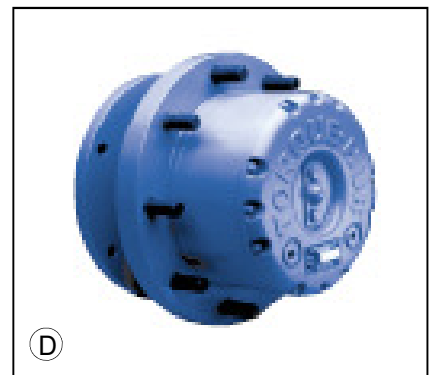

FIG. 4.15-4

CUMMINS ENGINE AND TANDEM PUMP– The STS 10T comes standard with a 215hp Cummins diesel engine (fig. 4.15-1). The engine has a direct-mounted Sauer-Danfoss 90 Series tandem hydrostatic pump (fig. 4.15-2). More information on the operation of the engine is on the next page.

WHEEL MOTORS AND WHEEL HUBS–The STS 10T's all-time four wheel drive system consists of the Sauer-Danfoss hydrostatic wheel motors (fig. 4.15-3) and the planetary gear reduction hubs (wheel hubs) (fig. 4.15-4).

IV. OPERATING SYSTEMS

B. HYDROSTATIC DRIVE SYSTEM

Operating The Engine



CAUTION

Start engine from operator's seat only. When running engine in a building, be sure there is adequate ventilation.



Pre-operational Checks	Section Reference
1. Check the engine oil level. Do not operate when oil is below the low mark on the dipstick.	6.6
2. Check the coolant level in the radiator and the coolant overflow reservoir.	6.8
3. Check the hydraulic oil reservoir level.	6.6
4. Check the cooling air intake screen	6.11
5. Drain fuel/water separator.	6.12
6. Check engine drive belt.	6.17
7. Drain any water out of the air tank daily.	6.23
8. Check for any oil or fuel leaks and correct them if needed.	

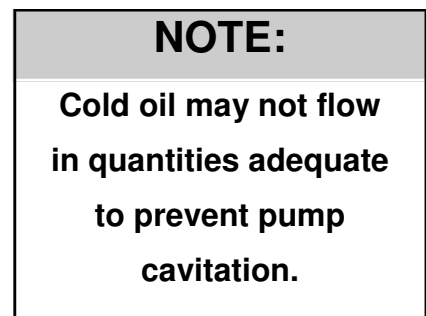
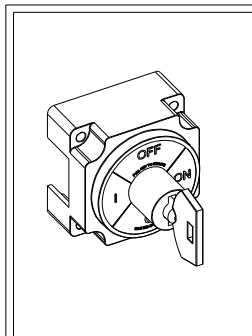

FIG. 4.16-1

BATTERY DISCONNECT- The STS 10T is set up with a battery disconnect safety device (fig. 4.16-1). This device is located on the left side of the rear frame cross tube. When the key is turned to the OFF position the electrical circuit is broken therefore rendering the machine unable to start. Do not use this device as a safety when working on the electrical system— disconnect the negative battery cable before servicing.

This device is also used as an anti-theft safeguard. Keep the key in a safe place, out of the machine when it is not in use.



IMPORTANT

Do not use disconnect to stop engine. Do not bypass disconnect. Do not terminate electrical devices to battery terminals. Disconnect negative before servicing electrical equipment. Completely isolate electronics before welding. Key must be inserted and rotated to "ON" position for operation.

660072

IV. OPERATING SYSTEMS

B. HYDROSTATIC DRIVE SYSTEM

STARTING THE ENGINE-

1. Position the hydrostatic lever to “N” (neutral) position (fig. 4.17-1).
2. Put the parking brake switch(fig. 4.17-2) to the ON position (see below). Turn the ignition key switch to the on position, wait for the “wait to start” light in the message center (fig. 4.17-3) to go out before engaging the starter. If the engine fails to start after 15 seconds, turn the key to OFF, wait one minute and repeat the procedure. If the engine does not start in three attempts, check the fuel supply system. Absence of blue or white exhaust smoke during cranking indicates that no fuel is being delivered.
3. Observe the warning lights on the message center after start up. If any functions do not operate, shut off engine and determine the cause.
4. Always allow at least a five minute warm-up period before operating the engine at high RPM. This means that the engine must reach operating temperature and oil pressure must stabilize in the normal operating range before it is run faster than an idle (1000 RPM or less).

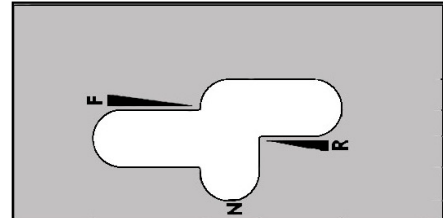

FIG. 4.17-1



FIG. 4.17-2



FIG. 4.17-3

PARKING BRAKE- The parking brake will engage if the charge pressure falls below 150 PSI or the engine is shut off. To engage the brakes manually, press the top of the PARKING BRAKE/LADDER switch (fig. 4.17-2) located on the side console.

To disengage the brakes, press the bottom of the switch. Always turn the brakes off before moving the sprayer.

The brake switch must be engaged to lower the ladder and to run the side-fill or pressure washer. The ladder will automatically lower when brake switch is pressed (see page 4.21)

NOTE:

The parking brake will not engage over 1 mile per hour.



CAUTION

Activating the brake switch while the machine is moving is potentially hazardous to the operator and the sprayer.

IV. OPERATING SYSTEMS

B. HYDROSTATIC DRIVE SYSTEM

ACE: AUTOMATICALLY CONTROLLED ENGINE-

1. Speed ranges are selected by a red (decrease speed range) and green (increase speed range) electronic switch mounted on the hydrostatic lever (fig. 4.18-1, item A). The lower the setting, the higher the torque, but the lower the speed.
2. Increase the engine one bump to gain RPM of 1800 with the throttle switch (fig. 4.18-2). More RPM will be gained as you move the hydrostatic lever forward.
3. To move forward, slowly push the hydrostatic lever forward. The farther the control lever is moved, the faster the sprayer will travel and the RPM 's will increase (fig. 4.18-3). To stop, slowly pull the lever to the "N" neutral position.
4. To reverse the machine, slowly pull the hydrostatic lever back. To stop, slowly push the lever to the "N" neutral position.
5. Before turning off the engine, reduce engine speed and allow the engine to idle at least three minutes.

NOTE:

Machine will not shift down until highest speed of desired range is met.

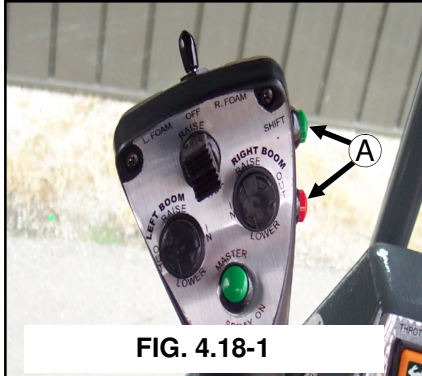

FIG. 4.18-1

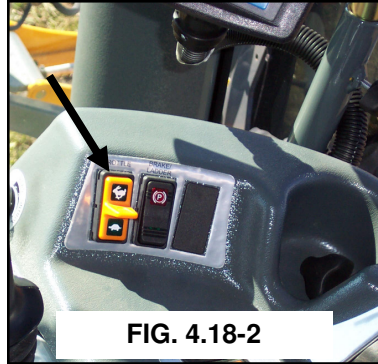

FIG. 4.18-2

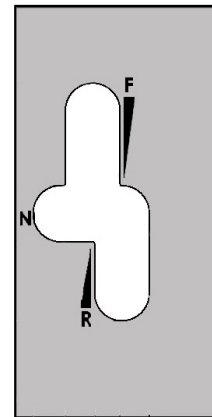

FIG. 4.18-3

SPEED CONTROL— Speed control may be adjusted with the speed control dial (fig. 4.18-4) This will conveniently help regain consistent field speeds when re-entering a field from the end rows.

To set a speed limit, start with the engine at one bump on the throttle switch or 1800 RPM 's and speed control dial all the way counterclockwise. Push the hydrostatic lever all the way forward. Now turn the speed control clockwise while observing ground speed and stop turning the dial when the desired ground speed is reached. Now your maximum field speed is set and you simply reposition the handle all the way forward to regain that speed.

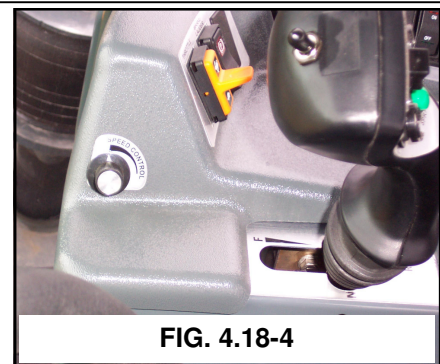

FIG. 4.18-4

IV. OPERATING SYSTEMS

C. HYDRAULIC SYSTEM



- A. Hydraulic Pump
- B. Power Steering
- C. Solution Pump
- D. Ladder
- E. Tread Adjust
- F. Spray Booms
- G. Gear Pump



FIG. 4.19-1

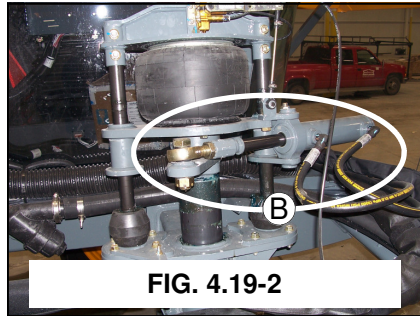

FIG. 4.19-2

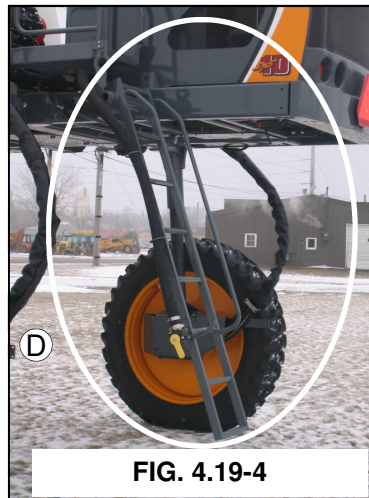

FIG. 4.19-4



FIG. 4.19-6

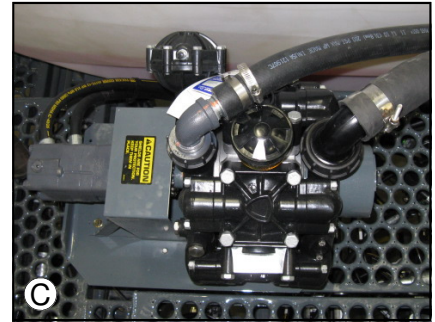

FIG. 4.19-3

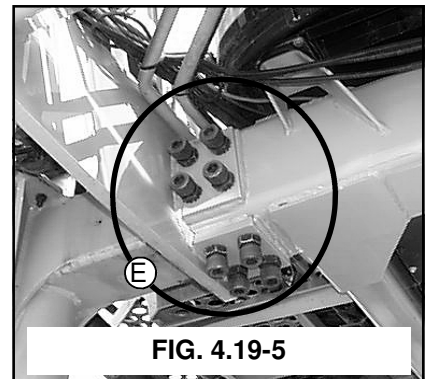

FIG. 4.19-5

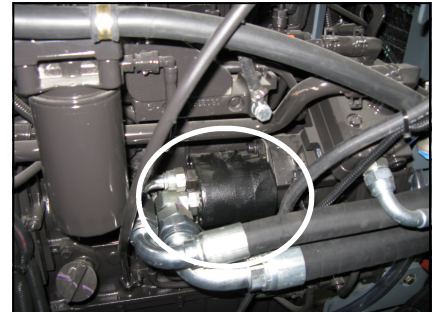

FIG. 4.19-7

The AUXILIARY HYDRAULIC SYSTEM is a load sensing, pressure compensated system with efficiency in mind. That means it only pumps the amount of oil needed to do the job.

The pump is mounted to the “front” of the second hydrostatic pump (fig. 4.19-1). The systems consist of a single variable displacement pump that supplies the required hydraulics to operate the full time power steering unit, boom control cylinders (lift, level, and fold), tread adjust, ladder, outer boom breakaway, and the solution pump.

The return oil from the load sense pump is mixed with the oil from the gear pump (4.19-7) on the side of the engine. This pump supplies a constant flow of oil from the hydraulic tank to the cooler and then back to the tank through the filter. This is considered a kidney loop and is dedicated to the cooling and filtration of the hydraulic system.

IV. OPERATING SYSTEMS

C. HYDRAULIC SYSTEM

HYDRAULIC PUMPS– The hydraulic pump (fig. 4.20-1) circulates the hydraulic oil throughout the necessary systems and back through a cooler before returning it to the reservoir.

If the level in the reservoir drops too low to safely operate the machine you must shut down the engine immediately to prevent damage to the hydraulic system.

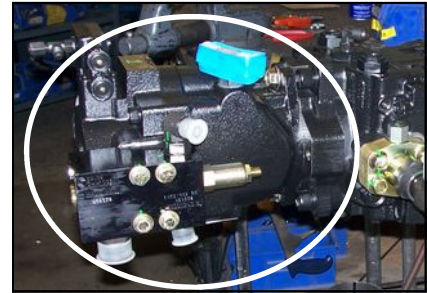

FIG. 4.20-1

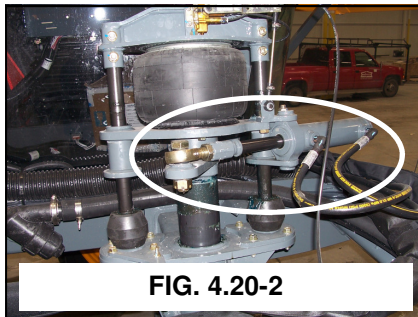

FIG. 4.20-2

POWER STEERING SYSTEM– The power steering is a dedicated circuit steering system with full time control, self centering/ double action steering cylinders.

SOLUTION PUMP– The solution pump (fig.04.20-4) is a diaphragm pump semi-hydraulically controlled with the pulse width modulated control

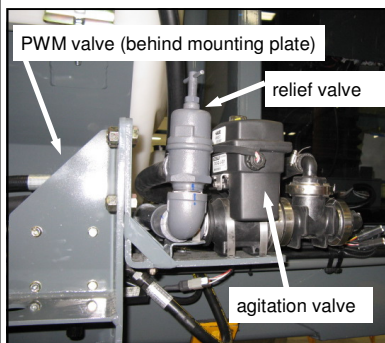

FIG. 4.20-4

valve (fig. 4.20-3). The valve is controlled by the Raven console per the calibration settings entered by the operator.

The solution pump is also used to distribute the water or cleaning solution from the rinse tank through the rinse systems.

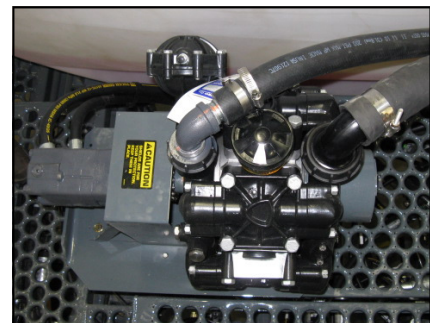

FIG. 4.20-4



FIG. 4.20-5

GEAR PUMP– The gear pump aids in the circulation of hydraulic oil through the filtration and cooling systems.

IV. OPERATING SYSTEMS

C. HYDRAULIC SYSTEM

CAUTION

Upright ladder is not a service platform or step. DO NOT step on the ladder while in upright position. DO NOT lower ladder while anyone is on the ground near the sprayer. DO NOT attempt to lower ladder from the ground level, ladder may swing quickly and strike an unsuspecting person.

LADDER- To raise or lower the ladder you will need to locate the BRAKE/LADDER switch at the front of the right hand console (fig. 4.21-3). When the brake is applied the ladder will lower automatically (fig. 4.21-1). The ladder will not raise (fig. 4.21-2) until the machine is running and the switch has been returned to the OFF position.

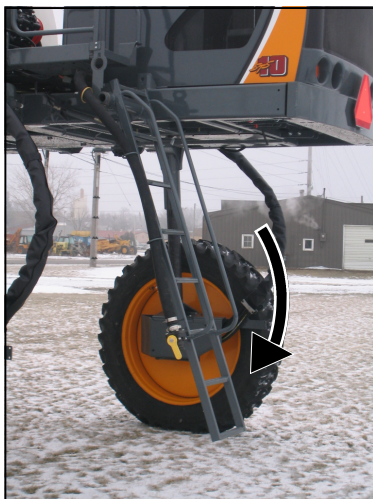

FIG. 4.21-1



FIG. 4.21-2



FIG. 4.21-3



IV. OPERATING SYSTEMS

C. HYDRAULIC SYSTEM

HYDRAULIC TREAD ADJUST– To adjust the tread width hydraulically (if equipped) follow the instructions below:

1. Survey the surroundings and allow yourself enough room to adjust the tread in either forward or reverse.
2. Locate the tread adjustment switches on the rear of the right hand console (fig. 4.22-1). They are marked LF (left front), LR (left rear), RF (right front), and RR (right rear). The legs may be moved in or out on each side independently*. While driving between one and two mph, press and hold the desired switches to move the tread in the desired direction. Pressing the top of the any switch will move that leg OUT and pressing the bottom of any switch will move that leg IN.
3. Observe the tread width on each leg. Front legs use indicator decals (fig. 4.22-2) while the rear legs use electronic sensors and the message center in the cab (fig. 4.22-3). Release the switch when the tread indicator reaches the desired tread marking.
4. After adjustment is complete, all four tread width indicators should have identical readings.
5. To recalibrate toe-in: while driving forward slowly, turn the steering wheel all the way one way until both steering cylinders bottom out; continue turning the wheel a little more to let fluid bypass the cylinder. Then turn the steering wheel all the way the other way and repeat the process. When wheels are then straightened, steering cylinders should be re-centered and correct toe-in should be obtained. This is referred to as “phasing”. (see Section G of Service and Maintenance)

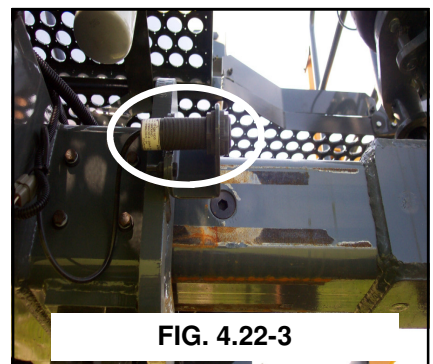
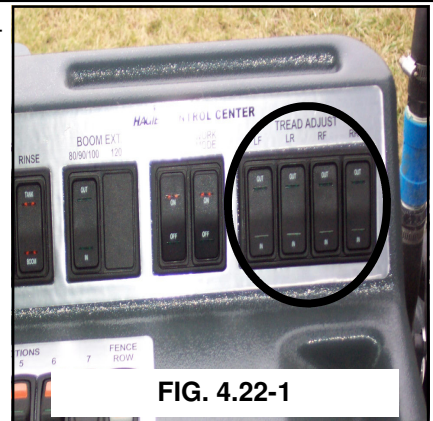

* When a significant adjustment is being made, it is recommended that you adjust one leg at a time and do the adjustment in smaller increments. Binding may occur if a larger adjustment is made all at once, especially if adjusting one leg at a time.



Never adjust the hydraulic tread on a public roadway. Make sure the sprayer is on level ground where there are no ditches or valleys to interfere when you perform the adjustment.

IV. OPERATING SYSTEMS

C. HYDRAULIC SYSTEM

SPRAY BOOMS

The spray booms (fig. 4.23-1) are controlled by an electro-hydraulic system. This system consists of operator manipulated switches located in the sprayer's cab and hydraulic cylinders attached to the booms. It provides control of lift, level, and horizontal extension.



4.23-1

IV. OPERATING SYSTEMS

C. HYDRAULIC SYSTEM

Lift

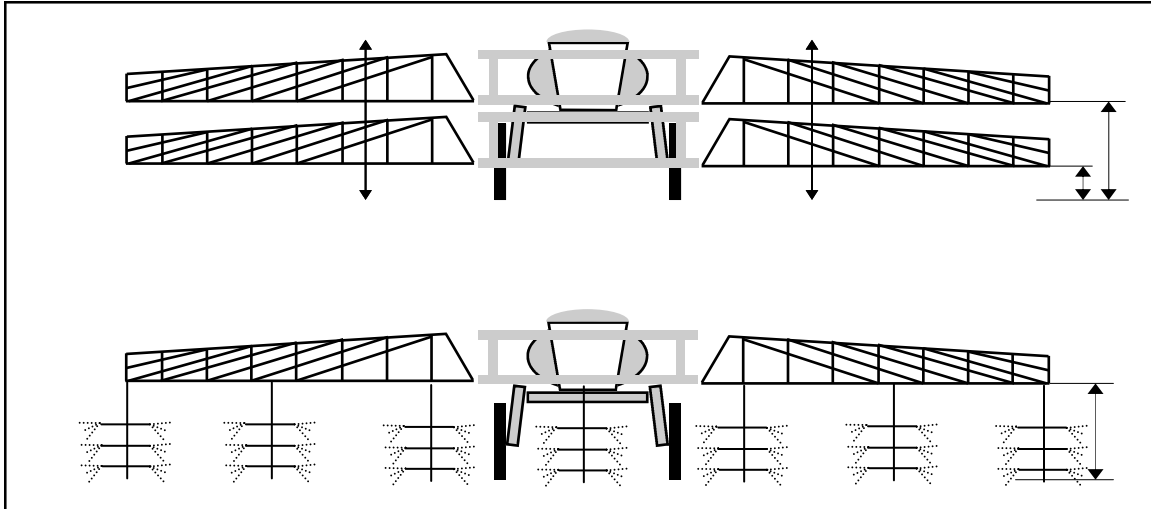

FIG. 4.24-3

NOTE:

See your spray tip manufacturer's guide for information regarding spray tip height (fig. 4.24-3).



FIG. 4.24-1

To raise and lower the transom/boom assembly, depress the "square rocker" on the hydrostatic lever (fig. 4.24-1) and move it either UP or DOWN. While pressed, it will activate the transom lift cylinders (fig. 4.24-2).



FIG. 4.24-2

IV. OPERATING SYSTEMS

C. HYDRAULIC SYSTEM

Level

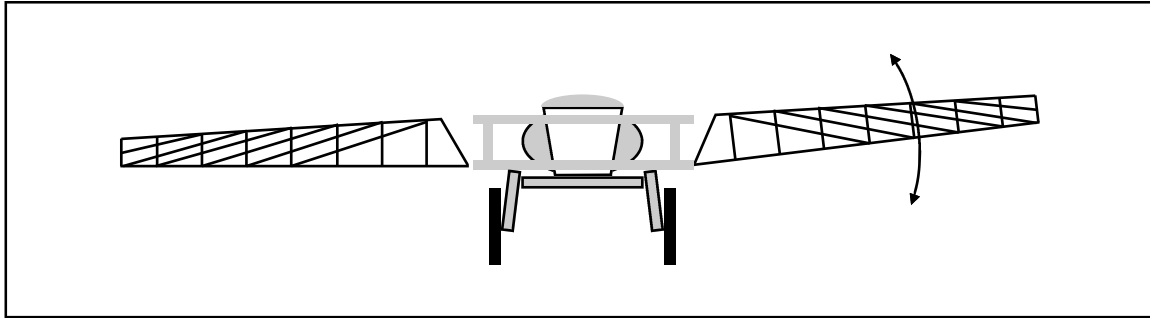

FIG. 4.25-1

To increase or decrease the angle of each individual boom level, depress the left or right “Round Rocker” UP or the left or right “Round Rocker” DOWN buttons on the hydrostatic lever (fig. 4.25-3). While depressed, these buttons activate the level cylinders connecting either boom to the transom (fig. 4.25-2).

This adjustment also aids in placing the booms correctly in the cradles for transporting and storing.



FIG. 4.25-2



FIG. 4.25-3

IV. OPERATING SYSTEMS

C. HYDRAULIC SYSTEM

Horizontal Boom Extension

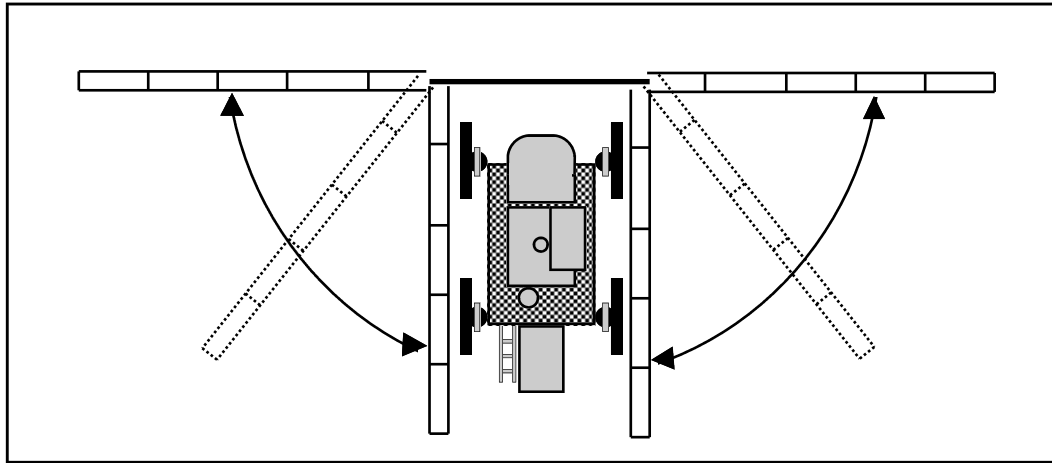

FIG. 4.26-1

HORIZONTAL BOOM EXTENSION - To fold either boom horizontally in toward the machine or out , depress the right or left Rocker “Boom Fold” switches on the hydrostatic lever (fig. 4.26-3). While depressed, these switches activate cylinders connecting either boom to the transom (fig. 4.26-2).

Fold or unfold the booms in an open area only. Make sure no one is standing in the boom extension’s travel path. Booms can be folded if speed is less than 5MPH.



FIG 4.26-2



FIG 4.26-3

IV. OPERATING SYSTEMS

D. SPRAY SYSTEM

Introduction

The spraying system is a constantly monitored and continuously adjusted computer controlled system. The cab mounted digital console receives information from various inputs to help determine GPM (gallons per minute) and GPA (gallons per acre).

In the following section, the components of the spray system will be explained. Please read the entire section before operating the STS spray system. This section is not designed to replace the Raven manual, the numbers may not reflect your specific situation. Read all manuals before operating this equipment.

Instructions

OPERATION	PAGE REFERENCE
1. Calibrate spray system console.	4.1-4.11 or Raven manual
2. Check contents and quantity in solution tank.	
NOTE:	
Never attempt to operate the spray system without solution in the spray tank. Operating the spray system with no solution in the tank will cause severe damage and void the warranty.	
3. Start engine.	4.3, 4.17
4. Open tank valves, if desired, activate the agitation system.	4.29, 4.30
5. Turn on the WORK MODE switch.	4.6
6. Turn on the main spray power.	4.32
7. Place individual boom solution valve switches to the ON position.	4.32
8. Slowly move the hydrostatic lever forward to obtain the desired ground speed.	4.18
9. Frequently observe the pressure gauge. When it drops to zero, or spray pattern deteriorates, shut off main spray power, solution pump, and agitation system until refilling solution.	4.30, 4.32, 4.29, 4.30, 4.31 or 4.32

IV. OPERATING SYSTEMS

D. SPRAY SYSTEM

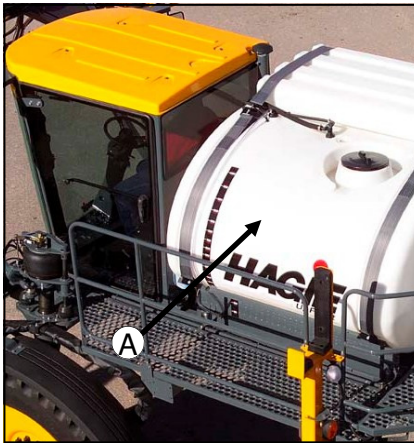

FIG. 4.28-1

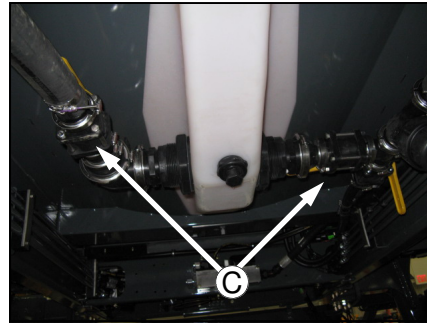

FIG 4.28-2

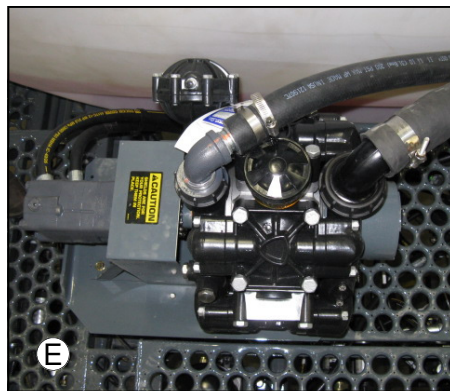

FIG. 4.28-4

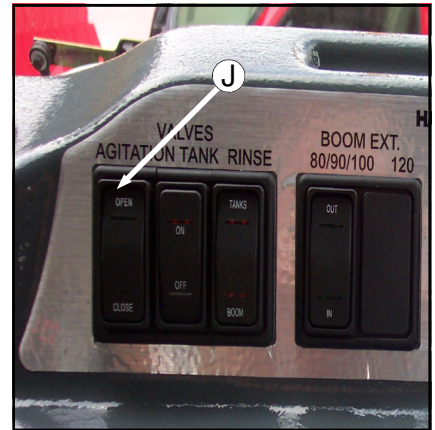

FIG 4.28-3



FIG. 4.28-5

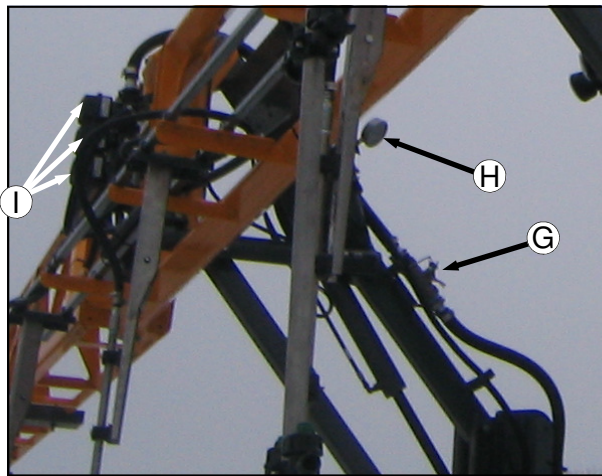

FIG. 4.28-6



FIG. 4.28-7



FIG. 4.28-9



FIG. 4.28.10



FIG. 4.28-8

- A. 1000g Poly Tank
- B. 1000g Stainless Steel Tank
- C. Solution/Rinse Tank Valves
- D. Agitation Valve Switch
- E. Solution Pump
- F. Individual Solution Control Valve Switches
- G. Flow Meter
- H. Pressure Gauge
- I. Individual Solution Control Valves
- J. Main Solution Spray Control Switch
- K. Spray Booms
- L. Raven Monitor
- M. Master Spray Indicator Light

IV. OPERATING SYSTEMS

D. SPRAY SYSTEMS

SOLUTION TANK– You have the option of the poly tank (fig. 4.29-1, item 1) or the stainless steel tank (fig. 4.29-1, item 2), both are 1000 gallon capacity. Their functions are similar, the only notable difference being the plumbing of the tanks. The poly tank has an eductor type agitation system and the stainless steel tank has a sparge type agitation system.

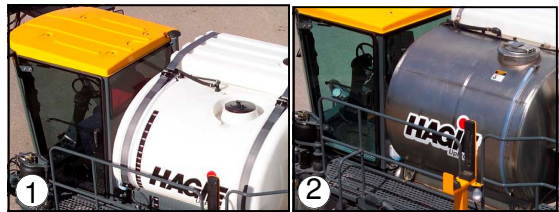

FIG. 4.29-1

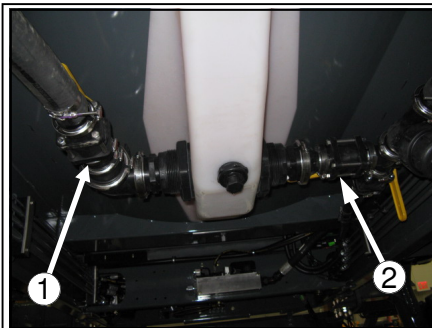

FIG 4.29-2

SOLUTION FILL VALVE– The solution tank valve (fig. 4.29-2, item 1) is a ball type valve that has to be opened and closed manually. It allows solution into the tank when it is open. The valve needs to be closed once filling is complete. The valve is controlled from inside the cab with the TANK VALVE switch (fig. 4.29-3) located on the right hand console.

SOLUTION PUMP VALVE– The solution pump valve (fig. 4.29-2, item 2) is a ball type valve that has to be turned on and off manually. This valve is to allow the fluid from the solution tank to flow to the solution pump.

RINSE TANK VALVE– The rinse tank valve (not shown) will allow fresh water to flow from the rinse tank through the solution pump and lines. This does not allow for the rinse of the solution tank. The solution pump valve must be closed to prevent contamination while rinsing.

SOLUTION PUMP– The solution pump (fig. 4.29-4) is a diaphragm type semi-hydraulic pump that is controlled by the Pulse Width Modulated Valve (fig. 4.29-5) and the Raven console (fig. 4.29-6). The pump draws the solution out of the tank at a rate determined during the calibration of the Raven console. It dispenses it through the many valves and hoses that make up the spray system. The pump also dispenses fluids through the agitation system and the rinse systems.



FIG. 4.29-4



FIG. 4.29-5



FIG. 4.29-6

IV. OPERATING SYSTEMS

D. SPRAY SYSTEMS

SOLUTION PRESSURE GAUGE– The pressure gauge (fig. 4.30-1, item 1) gives you a constant visual display of the amount of solution being applied (measured in PSI). The pressure, as determined by the pulse width modulated control valve, will vary according to ground speed. If applying solution manually, the solution pressure gauge visually informs the operator of needed manual adjustments. The gauge also shows when there is a drop in pressure indicating that the solution tank maybe empty or there is a problem with the system.

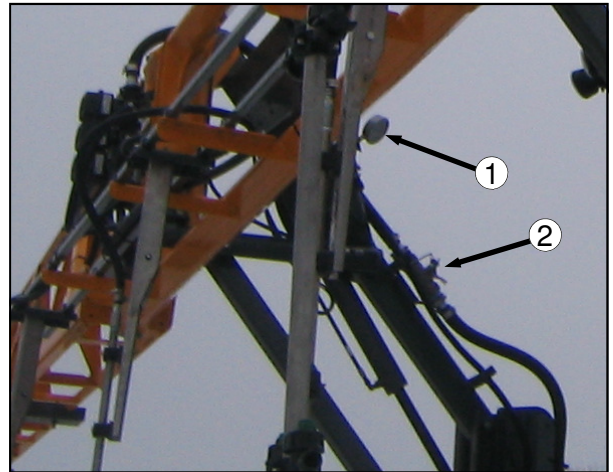

FIG. 4.30-1

FLOW METER– The flow meter located in the main solution line (fig. 4.30-2, item 2) monitors the solution flow and sends information back to the console and control valve. If the flow rate is not within the parameters programmed, the control valve will compensate by either opening or closing. If the rate continues to be outside the parameters an alarm will sound signaling a low flow rate. (See the Raven console guide for more information on low flow limit)

AGITATION– The speed of the sparge agitation system (stainless steel tank option) or the eductor agitation system (poly tank) is controlled by a variable flow solution valve (fig. 4.30-2, item 1) mounted on the solution pump (fig. 4.30-2, item 2). The agitation switch (fig. 4.30-3) on the right hand console controls the rate of flow through

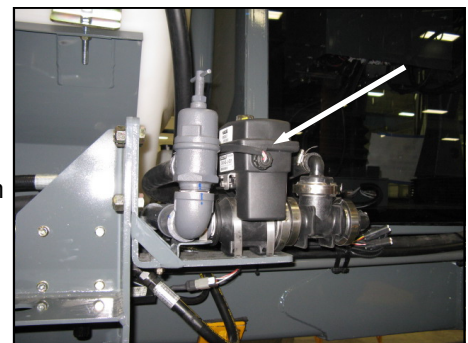

FIG 4.30-3



FIG 4.30-3

the sparge system. While watching the indicator on the agitation valve, increase or decrease the flow rate with the control switch. To increase the flow, press the switch up. To decrease the flow, press the switch down. When the desired rate of flow is achieved, release the switch.

To turn the agitation system off, decrease the flow rate all the way.

IV. OPERATING SYSTEMS

D. SPRAY SYSTEMS

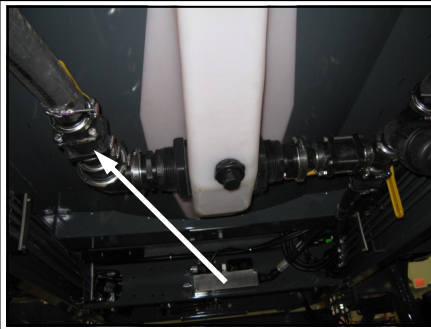

FIG 4.31-1

next page for information regarding the use of the side fill inductor for filling the solution tank.

SOLUTION QUICK FILL– To fill the solution tank, make sure the solution fill valve under the tank (fig. 4.31-1) and the valve on the ladder is open. With the ladder down, you can attach the owner supplied connection to the solution fill connection. Fill to the desired level. When finished, shut all of the valves and return the front fill to the locked position. See the



FIG. 4.31-2

IV. OPERATING SYSTEMS

D. SPRAY SYSTEMS

BOOM SOLUTION VALVE SWITCHES– The spray booms are divided into sections that are independently supplied with solution and can therefore be shut off or turned on independently. The electronic boom solution valves are controlled by a row of switches mounted on the right hand console (fig. 4.32-1). The first and fifth switches do not control anything and neither does the fence row switch.



FIG. 4.32-1

Seventy foot boom configurations are divided into three sections and the valves are mounted on the transom.



FIG. 4.32-2

MAIN SOLUTION SWITCH– Main spray power can be controlled from a switch on the hydrostatic control lever (fig. 4.32-2). This controls the panel of boom solution valve switches. The main switch must be on to supply the individual switches with voltage. This allows you to turn all of the boom solution valves ON or OFF at the same time such as turning it off when you arrive at the end rows of a field and turning it back on when you re-enter the field. The individual switches allow you to turn the valves on or off separately.

When the main spray power is ON a green indicator light mounted on the right side of the message center (fig. 4.32-3) will illuminate.



FIG. 4.32.3

NOTE:

DO NOT allow the pump to keep running when the boom switches are turned off. Failure to do so will generate in over-heating and cause severe pump damage and void the warranty.

V. TRANSPORTING

A. CRADLING THE BOOMS

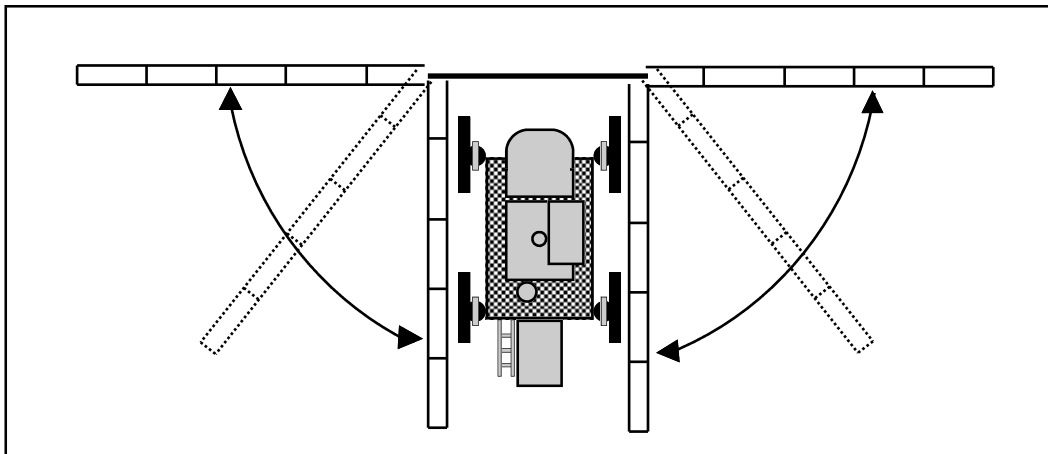

The booms should always be cradled before traveling, transporting, or parking for an extended period of time. **The booms must be folded when cradled.**

To cradle the booms, fold the boom extensions in, raise the transom, and fold the booms in toward the machine. When the boom reaches the last 8-10 degrees of travel, it will automatically slow down to avoid impact with the cradle. Raise each individual boom level until it clears the outer cradle stop (fig. 5.1-1). Fold the boom in toward the cradle back-stop. When it touches the back-stop, lower the boom level until the full weight of the boom rests in the cradle (fig. 5.1-2).



FIG 5.1-1



FIG 5.1-2

V. TRANSPORTING

B. DRIVING

WHEN DRIVING THE SPRAYER ON A PUBLIC ROAD OR HIGHWAY, DRIVE CAREFULLY AND FOLLOW THESE STEPS:

1. Always have the booms in the folded position and cradled when driving or transporting.
2. Flashing hazard/warning lights have been placed on the sprayer to warn other drivers.
3. Know and obey all state laws for driving farm equipment on a public road or highway.
4. Adjust the sprayer's speed to suit the conditions.
5. Slow down and use turn signals before turning.
6. Pull over to the side of the road before stopping.
7. Keep a proper lookout, and maintain control of the sprayer.
8. Do not drive under trees, bridges, wires, or other obstructions unless there is clearance.
9. Use extra care before entering or leaving a public road or highway.
10. A SMV (Slow Moving Vehicle) emblem has been mounted on the sprayer to warn other drivers that one is moving slowly. Keep it properly displayed, unless prohibited by law.
11. Do not drive sprayer at speeds exceeding 20mph with solution in the tank.

WARNING

DO NOT operate the machine at speeds exceeding 20mph with solution in the tank. Operating at speeds exceeding 20mph with a loaded tank may result in tire blow out or wheel hub damage and void the warranty.
NEVER operate machine on a public roadway with solution in the tank!



NOTE:

The Model STS 10T should never be towed under any circumstances.* Machine damage will occur and void the power train warranty.

* Contact Hagie Customer Support if towing is necessary.

VI. SERVICE AND MAINTENANCE

A. SERVICE POINT QUICK REFERENCE CHART

PAGE #	SERVICE POINT	CLEAN	CHANGE	CHECK	GREASE	DRAIN
6.6	ENGINE OIL		500HRS	DAILY		
6.12	ENGINE LUBE FILTER		500HRS			
6.8	RADIATOR COOLANT		1000HRS	DAILY		
6.8	COOLANT CONCENTRATION		AS REQ	500HRS		
6.11	RADIATOR GRILLE SCREEN	AS REQ		DAILY		
6.17	ENGINE DRIVE BELT		AS REQ	DAILY		
6.17	A/C COMPRESSOR BELT		AS REQ	250HRS		
6.7	A/C COMPRESSOR		B			
6.12	FUEL FILTER (WATER SEPARATOR)		500HRS*			DAILY
6.12	REMOTE FUEL FILTER		500HRS*			
6.12	IN-LINE FUEL STRAINER		500HRS*			
6.10	AIR INTAKE FILTER	I	C			
6.10	FILTER MINDER®		D	DAILY		
6.6	HYDRAULIC RESERVOIR OIL LEVEL		500HRS	DAILY		
6.11	HYDRAULIC RETURN/SUCTION FILTER		E*			
6.11	HYDRAULIC SUCTION STRAINER	500HRS				
6.13	SOLUTION LINE STRAINER	AS REQ		DAILY		
6.7	WHEEL HUB OIL LEVEL		F*	100HRS		
6.22	WET TANK/AIR TANK					A
6.22	AIR DRYER CARTRIDGE		1000HRS	50HRS		
6.14	FRONT LEG STRG ZERKS (2- 1EA LEG)				50HRS	
6.14	ALL OTHER GREASE ZERKS (19 PLACES)				50HRS	
6.19	TREAD ADJUSTMENT BEARING TORQUE		AS REQ	J		
6.15	BATTERIES	100HRS	AS REQ	DAILY		
6.18	LUG NUT TORQUE			G		
6.22	TIRE PRESSURE			50HRS		
6.13	FRESH AIR (PAPER) CAB FILTER	50HRS	AS REQ			
6.13	CHARCOAL CAB FILTER		AS REQ			
6.23	SPRAY NOZZLE DIAPHRAGMS & TIPS		1000HRS	500HRS*		
6.22	AIRBAGS (VISUALLY)			50HRS		

- *AT THE BEGINNING OF THE SEASON (YEARLY) OR AS REQUIRED, WHICHEVER COMES FIRST
- NOTE A: CHECK FOR EXCESSIVE MOISTURE
- NOTE B: CHARGE AS REQ; USE PROPER EQUIPMENT
- NOTE C: FOLLOW FILTER MINDER READINGS
- NOTE D: RESET EACH TIME YOU SERVICE AIR FILTER
- NOTE E: 1ST 50HRS, THEN 250HRS THEREAFTER
- NOTE F: 1ST 50HRS, THEN YEARLY
- NOTE G: IMMEDIATELY, THEN 50HRS THEREAFTER
- NOTE I: NOT RECOMMENDED
- NOTE J: VISUALLY CHECK THE BOLTS EVERY 50 HOURS, TORQUE CHECK EVERY 100 HOURS

VI. SERVICE AND MAINTENANCE

A. SERVICE POINT QUICK REFERENCE CHART

SERVICE INTERVALS

Initial checks after receiving machine

IMMEDIATELY  then 

- 1) Check lug nut torque, then every 50 hours (page 6.18)

FIRST 50 HOURS  then 

- 1) Change wheel hub oil, again at 100 hours, and then every 500 hours thereafter (page 6.7)
- 2) Change hydraulic return/suction filter, then every 250 hours thereafter (page 6.11)

Daily 

- 1) Check engine oil (page 6.6)
- 2) Check and drain fuel filter (water separator) (page 6.12)
- 3) Check radiator coolant level (page 6.8)
- 4) Check engine drive belt (page 6.17)
- 5) Check Filter Minder[®] (page 6.10)
- 6) Check hydraulic oil reservoir level (page 6.6)
- 7) Check solution line strainer (page 6.12)
- 8) Drain wet tank and air tank (page 6.22)
- 9) Check batteries (page 6.15)
- 10) Check radiator grille screen (6.11)

VI. SERVICE AND MAINTENANCE

A. SERVICE POINT QUICK REFERENCE CHART

As Required



- 1) Change coolant concentration (page 6.8)
- 2) Clean radiator grille screen (page 6.11)
- 3) Change engine drive belt (page 6.17)
- 4) Change A/C compressor belt (page 6.17)
- 5) Charge A/C compressor (page 6.7)
- 6) Change fuel filter (water separator) (page 6.12)
- 7) Change in-line fuel strainer and remote fuel filter (page 6.12)
- 8) Clean solution line strainer (page 6.13)
- 9) Change batteries (page 6.15)
- 10) Change paper cab filter (page 6.13)
- 11) Change charcoal cab filter (page 6.13)
- 12) Check and replace spray nozzle diaphragms and spray tip (page 6.23)

Every 50 HOURS



- 1) Check tire pressure (page 6.22)
- 2) Check lug nut torque (page 6.18)
- 3) Visually inspect tread adjust bearing bolts (page 6.19)
- 4) Grease all lubrication zerks (page 6.14)
- 5) Knock particles from fresh air intake cab filter (page 6.13)
- 6) Check air dryer cartridge (page 6.22)

Every 100 HOURS



- 1) Check wheel hub oil level (page 6.7)
- 2) Clean batteries (page 6.15)
- 3) Torque check tread adjust bearing bolts (6.19)

VI. SERVICE AND MAINTENANCE

A. SERVICE POINT QUICK REFERENCE CHART

Every 250 HOURS

- 1) Check A/C compressor belt (page 6.17)
- 2) Change hydrostatic charge pressure and suction filter (page 6.11)

Every 500 HOURS or

- 1) Check coolant concentration (page 6.8)
- 2) Change fuel filter (water separator) (page 6.12)
- 3) Change hydraulic reservoir oil (page 6.6)
- 4) Change wheel hub oil (page 6.7)
- 5) Check spray nozzle diaphragms and spray tips (page 6.23)
- 6) Change engine oil (page 6.6) and lube filter (6.12)
- 7) Change the in-line fuel strainer (page 6.12)
- 8) Change the remote fuel filter (page 6.12)

Every 1000 HOURS or

- 1) Change radiator coolant (page 6.8)
- 2) Change air dryer cartridge (page 6.22)
- 3) Change spray nozzles and tips (page 6.23)

VI. SERVICE AND MAINTENANCE

A. SERVICE POINT QUICK REFERENCE CHART

DAILY INSPECTION

Inspection Point	Action (if necessary)
Check	
Engine oil level	Add oil
Radiator coolant level.....	Add antifreeze solution
Engine drive belt.....	Replace belt
Filter Minder®	Replace air filter element/ reset gauge
Hydraulic reservoir oil level.....	Add hydraulic oil
Solution line strainer	Remove and clean
Batteries	Clean and/or tighten
Radiator grille screen	Clean
Look for loose or missing items such as shields.....	Tighten or replace
Look for any fluid leaks pooled on machine or ground	Determine cause and correct

Drain

Fuel/water separator	See page 6.12
Wet tank/air tank	See page 6.22

VI. SERVICE AND MAINTENANCE

B. FLUIDS

ENGINE OIL

OIL LEVEL—The engine oil level dipstick is located on the left-hand side of the engine (fig. 6.6-1). Never operate the engine with the oil level below the “L” (low) mark or above the “H” (high) mark. Wait at least five minutes after shutting off the engine to check the oil level, this allows the oil to drain to the oil pan. Check the engine oil level daily.

CAPACITY— Low to high mark capacity is 2.0 quarts. Engine oil pan capacity is 17 quarts. Change every 500 hours. Refill with 15W40 diesel engine oil.



FIG 6.6-1

NOTE:

The engine must be level when checking the oil level to make sure the measurement is correct.

HYDRAULIC OIL RESERVOIR

OIL LEVEL— Check the sight gauge level on the hydraulic oil reservoir (fig. 6.6-2) daily. Add just enough fluid so the level is in the center of the sight gauge. Always check the hydraulic oil level when it is cool. Hydraulic oil will expand when heated.

TYPE— Premium hydraulic fluids containing high quality rust/oxidation/ and foam inhibitors are required. Hydraulic oil must conform to one of the following types: anti-wear hydraulic oil, type F automatic transmission fluid, or agricultural hydraulic transmission fluid. Replace the oil in the hydraulic reservoir at 500 hours or at the beginning of each spraying season, whichever comes first.



FIG 6.6-2

NOTE:

CLEANLINESS STANDARD: Always make sure area is clean before changing filter or hydraulic oil.

VI. SERVICE AND MAINTENANCE

B. FLUIDS

WHEEL HUB OIL

FAIRFIELD TORQUE HUB®

OIL LEVEL— Each wheel hub should maintain a level of half full at all times. Less than that would limit lubrication and over that would cause overheating and damage. To check the oil level position the hub so that there is a plug at the 12 O'clock position (fig. 6.7-2, item A) and the another at the 3 or 9 O'clock position (fig. 6.7-2, item B). Remove the lower plug (fig. 6.7-2, item B), if no oil comes out, the oil level is too low. Check the oil level every 100 hours.

If SAE 80W/90 or SAE 85W/140 with EP features oil is needed, remove the top plug and fill just until the oil starts to come out the lower hole (approximately 84 ounces on a hub without brakes or 62 ounces on a hub with brakes). With the oil at a satisfactory level, re-install plugs.

CHANGE— The wheel hub oil should be changed after the first 50 hours of field operation. Subsequently, it should be changed every 500 hours or yearly (whichever comes first). To change the wheel hub oil, position the plugs so that one is at the 6 O'clock position, and the other is at the 3 or 9 O'clock position. Remove the bottom plug to drain the oil. Once all of the oil is drained, re-install the bottom plug and remove the top plug. Re-fill wheel hub with gear oil as described above.

GENERAL MAINTENANCE (both hub types)— If your sprayer is going to sit for an extended period of time, occasionally rotate the hubs by driving the sprayer forward and backward at least 1/2 of a tire rotation to adequately coat all internal hub parts. This will prevent rusting if moisture inadvertently entered the hub during an oil change. Failure to rotate the hub and disperse oil may cause rusting and internal damage to the hub.

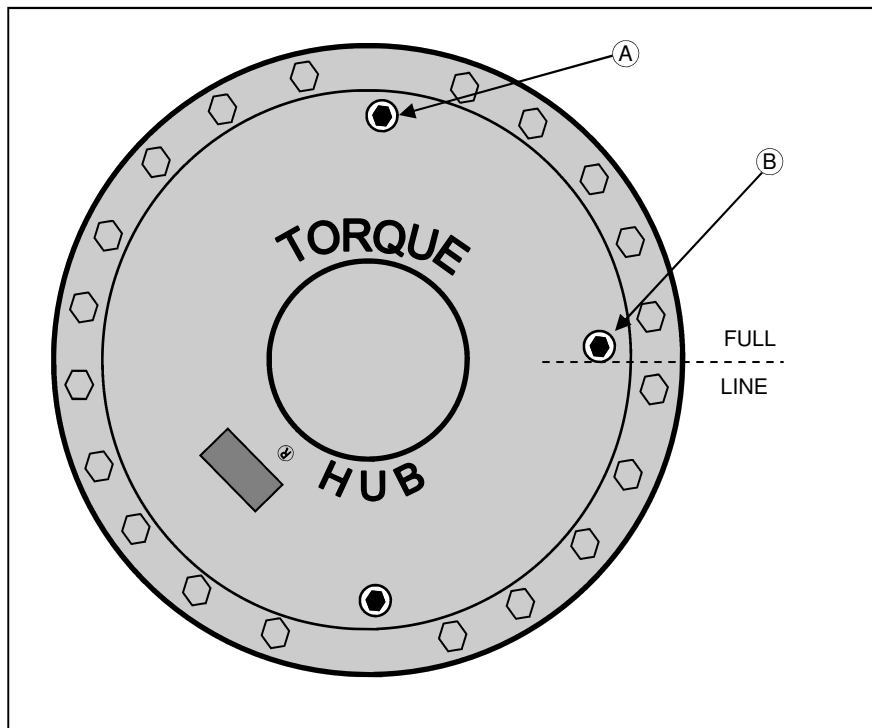

FIG 6.7-2

VI. SERVICE AND MAINTENANCE

B. FLUIDS

COOLING SYSTEM

COOLANT TYPE– Your cooling system should always be sufficiently charged with an adequate mixture of

antifreeze and water, regardless of the climate, in order to maintain a broad operating temperature range. Your cooling system has been factory charged with an ethylene-glycol based antifreeze.

CHECKING CONCENTRATION– The radiator cap is located toward the rear of the engine compartment (fig. 6.8-1). Never remove the cap from a hot engine. Always allow the engine to cool before servicing the cooling system.

A 50/50 antifreeze/water mixture is a conservative mixture which allows good protection against both overheating and freezing. If a stronger antifreeze mixture is required, be sure not to exceed the engine manufacturer's guidelines for antifreeze mixing. The table in figure 6.8-2 gives a few examples of ethylene-glycol antifreeze/water mixture protection values. Consult the engine manufacturer's handbook for further information.

Concentration should be checked every 500 hours or at the beginning of each winter, whichever comes first. A refractometer should be used to check concentration, "floating ball" type density testers are not accurate enough for use with heavy duty diesel cooling systems.

CHANGING COOLANT– Your coolant should periodically be changed to eliminate the buildup of harmful chemicals. Drain and replace the coolant every other spraying season or 1,000 hours of service, whichever comes first. Refill only with soft water because hard water contains minerals which break down the anti-corrosion properties of antifreeze.



FIG 6.8-1

Ethylene Glycol		
40%	-23°C	-10°F
50%	-37°C	-34°F
60%	-54°C	-65°F

FIG 6.8-2

WINDSHIELD WASHER FLUID

RESERVOIR– The windshield washer reservoir is located on the rear of the cab (fig. 6.8-2). Check it occasionally and refill it with non-refreezing automotive windshield cleaner as required.



FIG 6.8-2

VI. SERVICE AND MAINTENANCE

B. FLUIDS

FUEL

TYPE– No. 2 diesel fuel is recommended for the best economy and performance under most operating conditions. In operating conditions under 32°F, use a blend of No. 1 and No. 2 diesel fuel. The addition of No. 1 diesel fuel may cause loss of power and/or fuel economy.

STORING–See section 6 on storage.

REFUELING– Always turn off the engine and allow it to cool before refueling. Never smoke while fueling. Keep a fire extinguisher within reach while refueling.

The fuel cell on a STS holds 150 gallons– do not fill it completely: fuel can expand and run over. Wipe up all spilled fuel and clean with detergent and water before starting the engine.

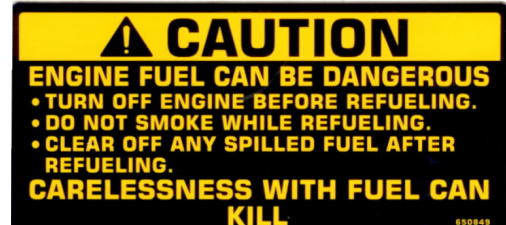

AIR CONDITIONING

TYPE– The cab on your sprayer is equipped with a R-134a air conditioning system (fig. 6.9-2).

RECHARGING– Recharge it only with R-134a refrigerant. If your air conditioning system is mistakenly charged with R-12 refrigerant, serious problems, such as compressor seizure, may result. Therefore, confirm refrigerant before recharging system.

If you do not have the proper recharging equipment, it is recommended that you allow an independent service agent service your air conditioning system.

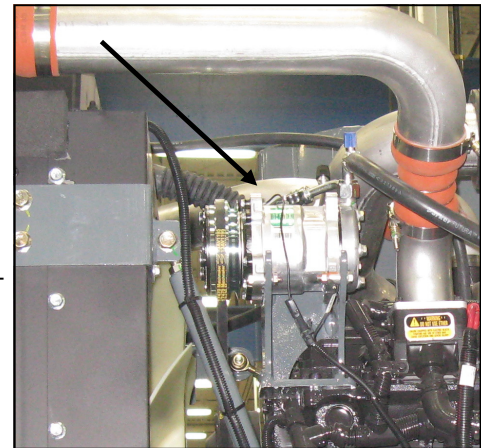

FIG 6.9-2

FLUID CAPACITIES AND TYPES

Engine oil pan, including filter	17 quarts SAE 15W-40
Engine oil dipstick, L-H mark.....	2 quarts
Hydraulic oil reservoir.....	32 gallons anti-wear hydraulic oil
Hydraulic system (reservoir, lines, filter, cooler, etc).....	55 gallons
Wheel hub oil level	
Farfield wheel hub (front 2)	approx. 84 oz. ea
(rear 2)	approx. 62 oz. ea
Engine cooling system	18 gallons ethylene glycol
Fuel cell	150 gallons No. 1 or 2 diesel

VI. SERVICE AND MAINTENANCE

C. FILTERS

ENGINE AIR INTAKE

LOCATION– The engine air intake filter is accessed by opening the door on the front of the engine compartment (fig. 6.10-1).

REMOVAL– The engine air intake filter element should only be removed if it is going to be replaced. After loosening the air cleaner clamp and removing the end cap, carefully remove the filter so as to not knock any dust off the filter and into the air intake passage (fig. 6.10-2). The secondary filter does not need to be replaced if the primary is intact.

REPLACEMENT– Your sprayer is equipped with a Filter Minder® to notify you of filter element efficiency. Follow its guidelines for servicing (see below). At appropriate service time, install the new element carefully to ensure proper sealing.

CLEANING– It is not recommended to clean the air intake filter element. However, a clean damp cloth should be used to wipe away dust and foreign material from the air cleaner housing.



FIG 6.10-1

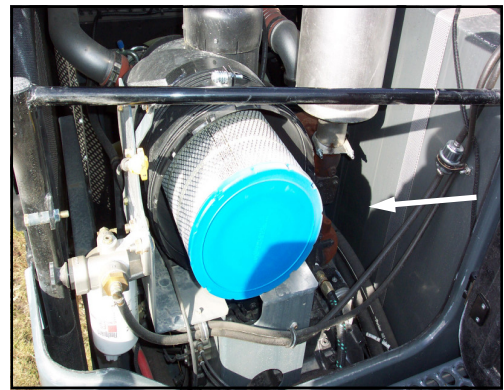

FIG 6.10-2

NOTE:

Do not tap filter to remove dust. Engine damage may occur due to crushed filter caused by tapping. If Filter Minder® indicates restriction, remove old filter, discard and install new filter only.

VI. SERVICE AND MAINTENANCE

C. FILTERS

RADIATOR SCREEN– In order to maintain air flow through the engine cooling system’s radiator, oil cooler, and air conditioning condenser, the cooling air intake grille (fig. 6.11-1) must be inspected often and periodically cleaned.

When the engine hood has been opened for servicing, use compressed air to dislodge most large trash and dirt. Blow out the screen AWAY from the machine. Water from a pressurized hose may also be used, or if necessary the screen may be soaked with soapy water and scrubbed gently with a brush.



FIG 6.11-1

NOTE:

When cleaning cooling fins of the radiator, oil cooler, or A/C condenser with compressed air or water, be careful not to damage cooling fins which may impair cooling capabilities.

NOTE:

Failure to keep cooling systems clean can cause over heating and damage to the hydrostatic system and/or engine.

HYDRAULIC FILTER AND STRAINERS

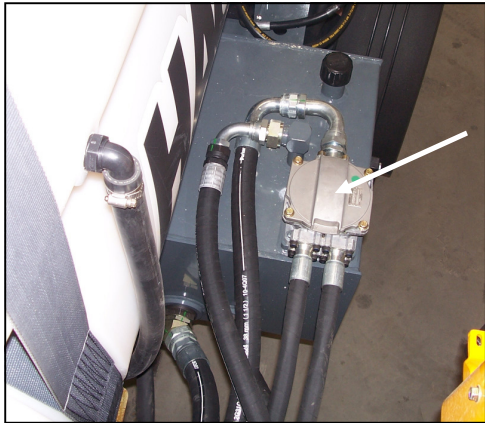

FIG 6.11-2

RETURN FILTER- Remove and install a new 10 micron rated return filter (fig. 6.11-2) at the end of the first 50 hours of use, subsequently replace the filter every 250 hours, or once a year, whichever comes first.

SUCTION STRAINERS– The suction strainers located inside of the tank should be examined for wear and blockage when the tank is empty for fluid service (see page 6.6).

FILL SCREEN-Replace the fill screen immediately if there are any signs of a tear or break. The screen is the first defense against

foreign materials entering the tank.

STRAINER BASKET– There is a strainer basket in the top fill opening of the poly solution tank (fig. 6.11-3). Check the basket for any debris before using the opening to fill the tank. Do not remove the strainer except for cleaning.

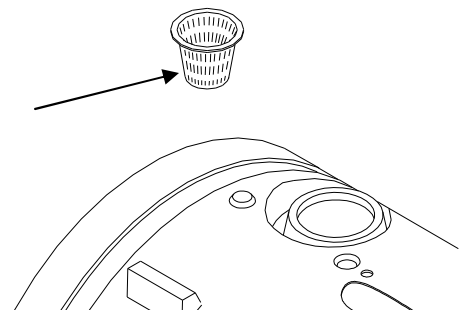

FIG 6.11-3

VI. SERVICE AND MAINTENANCE

C. FILTERS

ENGINE LUBE FILTER- The engine lube filter (oil filter) (fig. 6.12-1) should be changed every 500 hours or anytime that the oil is changed.

The filter is located under the service platform, behind the right rear wheel. It is accessible from the ground level.



FIG 6.12-1

FUEL FILTERS AND STRAINERS-

REMOTE FUEL FILTER- (fig. 6.12-2, item 1) Located near the air intake filter, this filter should be replaced every 500HRS or once a year, whichever comes first.



FIG 6.12-2



FIG 6.12-3

PRIMARY FUEL FILTER (WATER SEPARATOR)- (fig. 6.12-4) Located on the right side of the engine, this filter should be drained daily of the water and other deposits. Replace the filter every 500 hours or as necessary.

IN LINE STRAINER- (fig. 6.12-3) Located on the right hand side of the engine, above the air filter. Note the direction of the fuel flow arrow when replacing.



FIG 6.12-4

VI. SERVICE AND MAINTENANCE

C. FILTERS

OTHER STRAINERS

POLY RINSE TANK STRAINER– If you have the pressure washer option on your sprayer you will have a 100 mesh strainer in the line from the rinse tank to the pressure washer (refer to Hagie Parts Manual for location). Check the strainer for blockage if you are unable to get pressure.



FIG 6.13-1

RINSE STRAINER– The poly tanks have a 150PSI (32 mesh) strainer in the line from the rinse valve to the solution tank rinse. If you are experiencing issues with pressure through your rinse cycle, you may check this strainer.

SOLUTION LINE “Y” STRAINER– To help maintain consistent application rates, check the solution line strainer (fig. 6.13-1) daily for blockage. Clean the strainer screen as required. Be sure to wear appropriate clothing while removing and cleaning the line strainer screen. Confirm the gasket is in place before re-installing the screen.

Check all strainers occasionally for blockage and replace them if they show signs of deterioration. Refer to the Hagie Parts Manual for replacement part numbers and specific locations.

FRESH AIR CAB FILTERS

PAPER FILTER– The paper filter should be cleaned every 50 hours, or more often if necessary. Remove the paper element and gently tap it against a flat surface. Direct low pressure compressed air through the filter to remove larger particles. Replace the paper filter if necessary.

CHARCOAL FILTER– Remove and replace the charcoal filter at the first signs of chemical odor entering the cab.



FIG 6.13-3

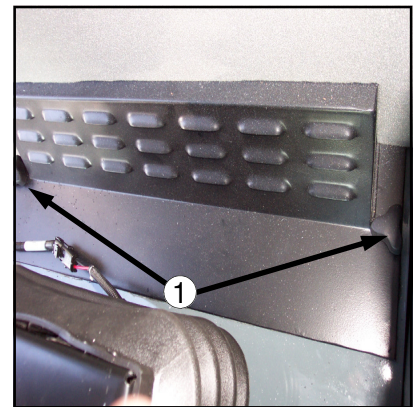

FIG 6.13-2

To remove, clean, or replace the filters in the cab, undo the thumb screws on the cover (figure 6.13-2, item 1) and carefully remove the filters. Wipe the cover clean with a damp cloth and allow to dry before replacing.

Figure 6.13-3 shows the air tube that allows fresh air into the cab. Check it often for any material blocking the opening.

VI. SERVICE AND MAINTENANCE

D. LUBRICATION

LEGS AND STEERING– The front legs have a grease zerk in the tie rod ball (figure 6.14-1, item 1) that needs greased every 50 hours or weekly.



FIG. 6.14-2

Both the front and rear legs have two grease zerks, one in each of the tower bearings (figure 6.14-1, item 2) that must be greased every 50 hours or as necessary. There is a zerk in the collar (figure 6.14-1, item 3) that also needs greased every 50 hours or as necessary.

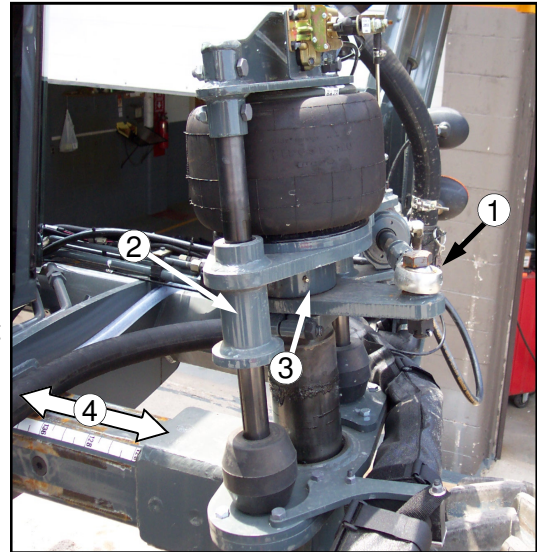

FIG. 6.14-1

The slide path of the tread adjust (figure 6.14-1, item 4) should be greased every 50 hours depending on the amount of usage.

Each leg also has a grease zerk on the inside of the leg (fig. 6.14-2) that should be greased every 50 hours. Tall crops may wipe away much of the grease, be sure to check each leg daily.

NOTE:

Failure to properly lube pivot points may result in unnecessary wear and damage.

NOTE:

DO NOT use air-type grease gun to lube leg towers, may result in seal distortion.

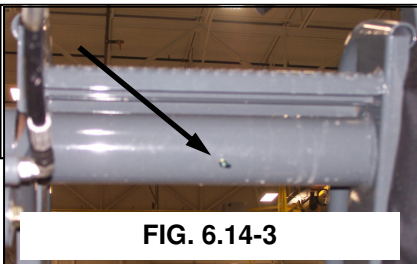

FIG. 6.14-3

LADDER– The ladder pivot tube (figure 6.14-3) has a grease zerk that needs to be lubed every 50 hours or as needed.

TRANSOM PIVOT TUBES– The transom pivot tube that attaches the booms to the transom has a grease zerk that should be greased every 50 hours or as needed depending on the amount of use.

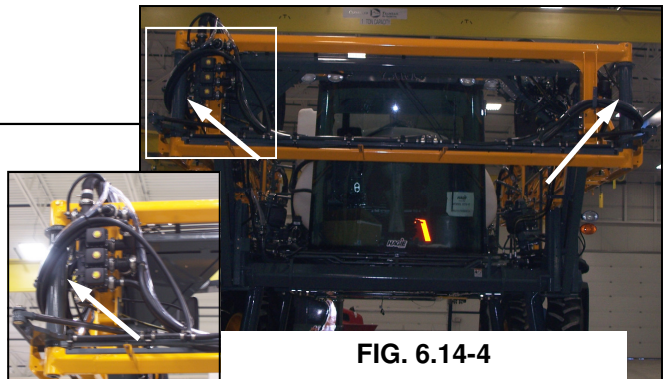

FIG. 6.14-4

VI. SERVICE AND MAINTENANCE

E. ELECTRICAL

BATTERIES

SERVICE ACCESS– The batteries are located at the rear of the machine behind the battery service access panel. (fig. 6.15-1)

CLEANING– Disconnect the battery cables from the batteries. Remove all corrosion with a wire brush or battery post brush. Wash the cable connections and battery posts with a weak solution of baking soda or ammonia. Apply dielectric or grease to prevent further corrosion. Reconnect the cables to the batteries making sure that they are tight. Clean every 100 hours.

CHARGING– To ease charging of the batteries, there is a set of auxiliary battery charging posts on the rear of the sprayer's mainframe (fig. 6.15-2). Connect your charging cables to them just as you would to the battery, positive cable to positive terminal, and negative cable to negative terminal. Keep these terminals clean and their caps in place when not in use.



FIG 6.15-1

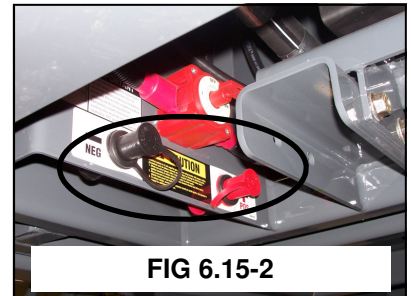

FIG 6.15-2



CAUTION

Batteries contain sulfuric acid. Avoid contact with skin, eyes, or clothing. Do not inhale fumes or ingest liquid. Batteries contain gases which can explode. Keep sparks and flame away while servicing.

Install replacement batteries with ratings equivalent to the specs below.

VOLTAGE 12 V (only)

CCA (30 sec. at 0° F)..... 950

RESERVE CAPACITY 185 min.
at 25 amps

NOTE:

To ensure the best electrical contact, battery terminal connections should be as clean and as tight as possible.

NOTE:

When servicing the electrical system always disconnect the batteries. Remove the ground cable first and connect it last.

VI. SERVICE AND MAINTENANCE

E. ELECTRICAL

CIRCUIT BREAKERS & FUSES– The STS has circuit breaker and fuse systems in various locations.

Under the right hand console (fig. 6.16-1) for the cab functions, under the cab (fig. 6.16-2) for the light functions, and the engine compartment (fig. 6.16-3) for the engine functions.

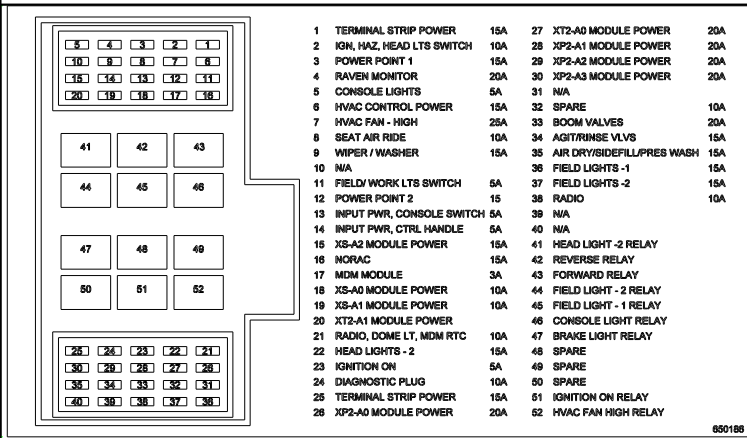

FIG 6.16-1

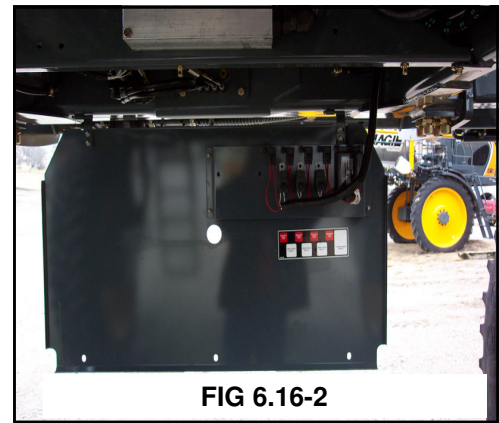
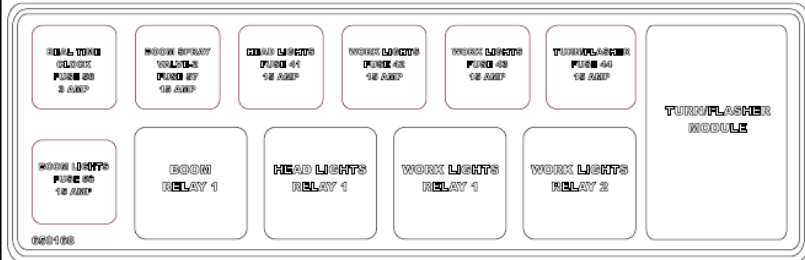

FIG 6.16-2

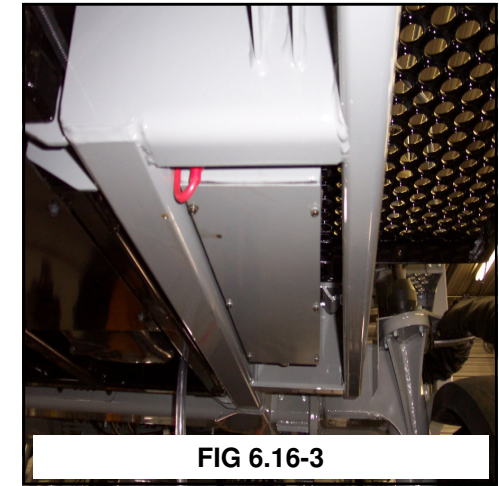
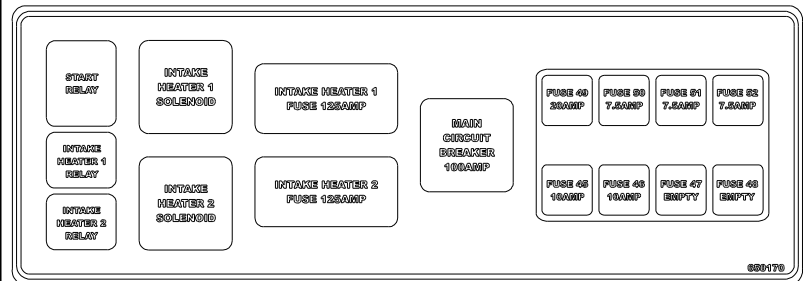

FIG 6.16-3

VI. SERVICE AND MAINTENANCE

F. BELTS

ENGINE DRIVE BELT

REMOVAL– Insert a 1/2 inch square ratchet drive (fig. 6.17-1) into the belt tensioner (fig. 6.17-2, item 1) and lift upward to remove the belt (fig. 6.17-2, item 2).

INSPECTION– Visually inspect the belt daily. Check the belt for intersecting cracks (fig.

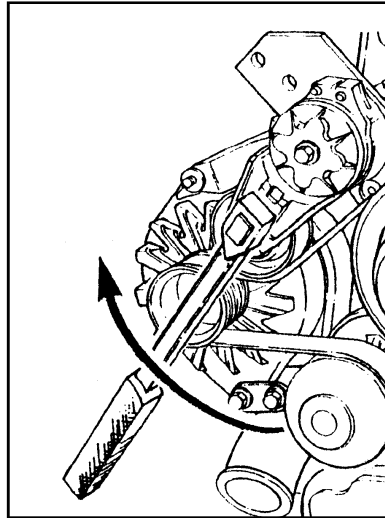

FIG 6.17-1

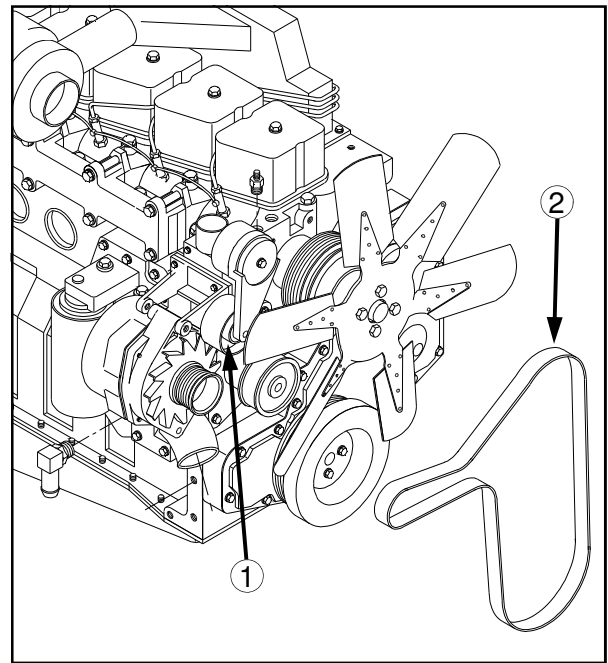

FIG 6.17-2

6.17-3). Transverse (across the belt width) cracks are acceptable. Longitudinal (direction of the belt length) cracks that intersect with transverse cracks are not acceptable. Replace the belt if it is frayed or has pieces of material missing.

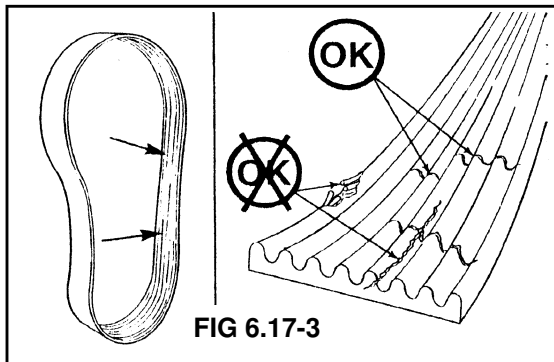

FIG 6.17-3

A/C COMPRESSOR BELT– To tighten air conditioner compressor belt, loosen the two pivot bolts (fig. 6.17-4, item 1) and the two slide bolts (fig. 6.17-4, item 2). Using a suitable prying tool, adjust tension on the belt to the desired tautness. While maintaining tension, re-tighten all four bolts. Inspect belt every 250 hours.

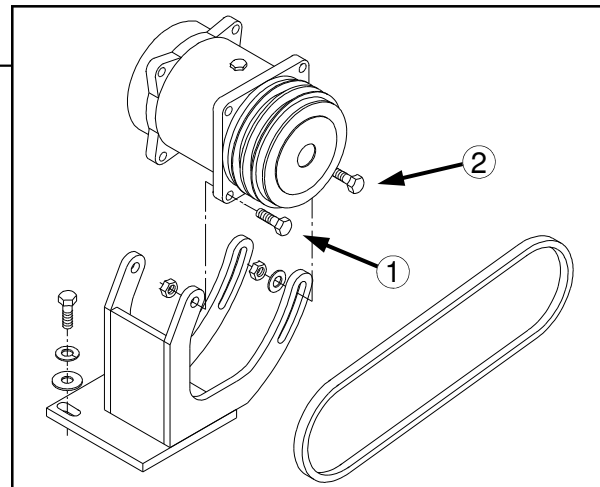

FIG 6.17-4

VI. SERVICE AND MAINTENANCE

G. BOLT TORQUE

WHEEL BOLTS– If you do not have the proper equipment to mount a tire, let your local qualified tire sales/service dealer mount the tire for you. The tire should be mounted on the rim according to figure 6.18-1 for best traction and tread cleaning action. To install wheel and tire assembly on the wheel hub lubricate studs with an anti-seize grease. Align the wheel bolt holes with the wheel hub studs and mount the wheel on the hub.

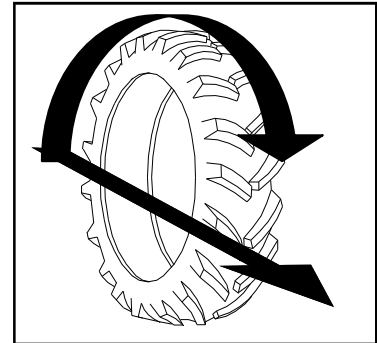

FIG 6.18-1

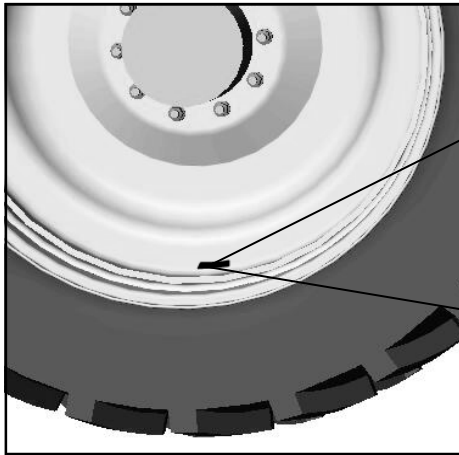

FIG 6.18-2

**Keep wheel bolts tight.
See owner's manual for
torque specifications.**

NOTE:

To achieve even torquing consistency, the tire should be completely off the ground.

Start all of the lug nuts and tighten them until they are just snug. Following the torque sequence in figure 6.18-3, first turn each lug nut to a torque value of 120 dry foot– pounds. Use slow, even pressure on the torque wrench. Quick or jerky movements cause inaccurate values. Repeat the same sequences to 150 dry foot– pounds and again finally to 400 to 500 dry foot– pounds.

If the wheel turns during lug nut torquing, lower the machine to the ground just enough for the tire to touch and prevent rotation or more preferably, place a suitable wedge between the tire and the ground.

Lower the machine and resume operation. Recheck torque after 30 minutes of operation.

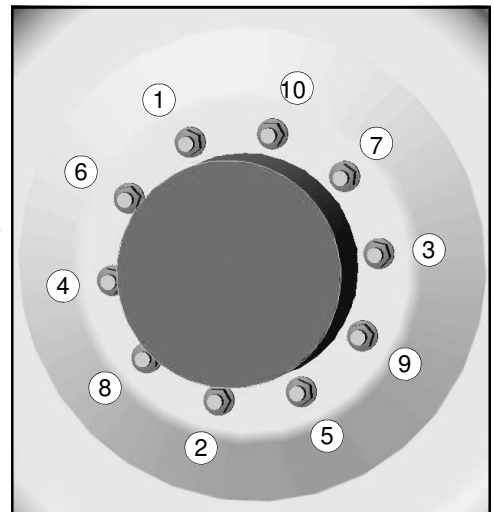

FIG 6.19-3



CAUTION

Check lug nut torque immediately after receiving machine and every 50 hours thereafter.

VI. SERVICE AND MAINTENANCE

G. BOLT TORQUE

HYDRAULIC TREAD ADJUST UNITS– With the engine turned off, visually inspect the tread bearing bolts on both the bottom and side tread adjust bearing plates (fig. 6.19-1) every 50 hours. Torque check them every 100 hours.

To torque check the tread adjust bearing bolts:

1. Loosen the jam nut (fig. 6.19-1, item 2) on each tread adjust bearing bolt.
2. Using an “X” pattern (fig. 6.19-2), verify that current torque on each tread adjust bearing bolt is equivalent to the last check from 100 hours previous.
3. Repeat pattern 3 to 4 times until last sequence shows no movement of the bolts to achieve desired torque.
4. Tighten jam nut.

Typically a torque value of 20 to 25 foot pounds is required to stabilize the axle and still allow tread width adjustment.

Even pressure of the tread adjust bearing plates is required for proper operation! (fig. 6.19-3) Figure A shows the correct position of the tread adjust bearing plates and bolts as well as the outer leg. Figure B shows the plates when there is not even torque on each of the tread adjust bearing bolts. Figure C shows a situation in which there is not enough torque on the tread adjust bearing bolts. Both figure B and C will cause the tread adjust to operate incorrectly or not at all.

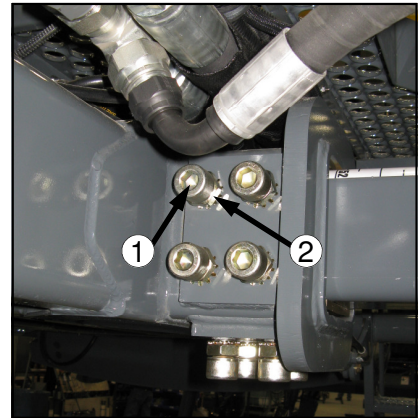

FIG 6.19-1

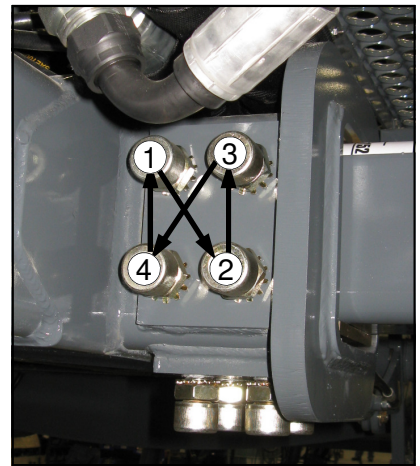

FIG 6.19-2

NOTE:

If hydraulic tread adjustment will never be used on your machine or you do not have hydraulic tread adjust, set all bearing bolt torque settings to 50 foot-pounds using the same procedure as stated above.

NOTE:

Never operate the unit with loose or missing tread adjust bearing bolts.

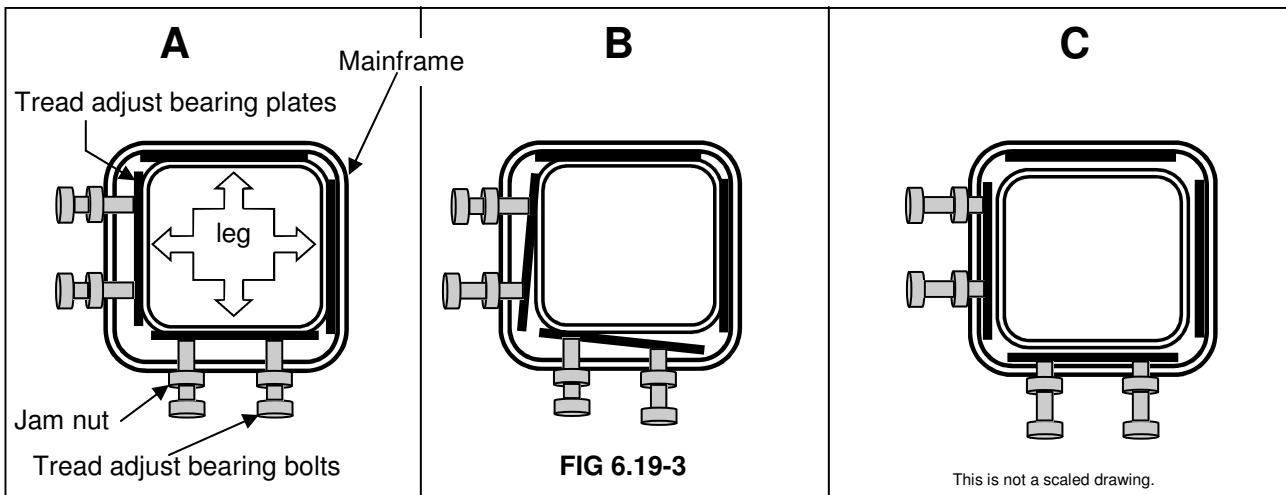

VI. SERVICE AND MAINTENANCE

H. TOE-IN

GAUGING TOE-IN— To correctly gauge toe-in, phase the cylinders first (page 4.22). Then use a tape measure placed at one-half the height on the front center seam of the front tire compared to the same measurement of the rear of the front tire (subtract the front measurement from the rear measurement— it must be a positive number). Correct toe-in should fall between one half and three quarters of an inch.

Toe-in is preset at the factory and should not have to be adjusted unless the steering cylinders are removed.

Difficulty steering one way versus the other or “darting” during operation, may indicate incorrect toe-in and may require adjustment.

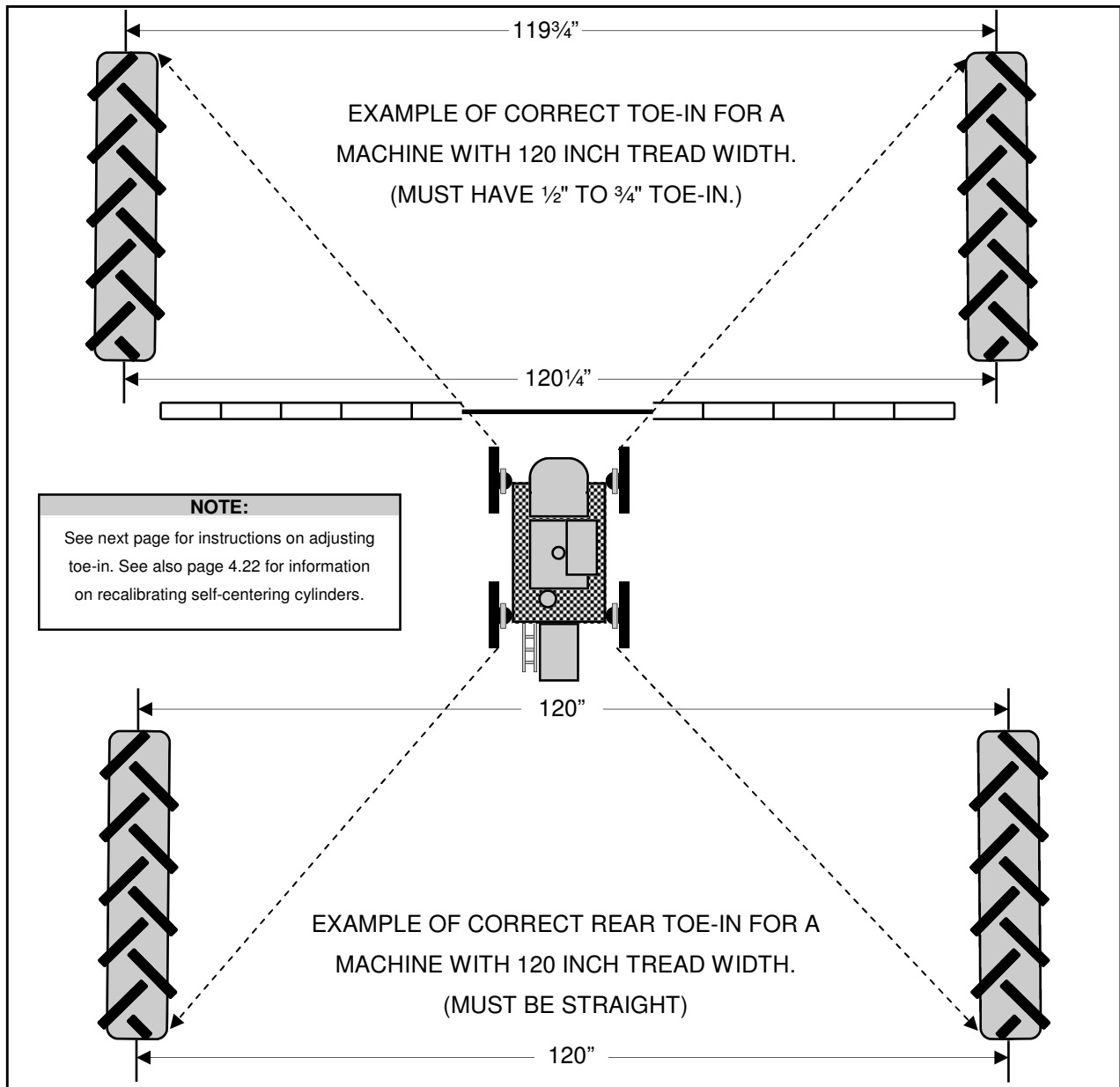

FIG 6.20-1

VI. SERVICE AND MAINTENANCE

H. TOE- IN

TOE-IN ADJUSTMENT– To adjust toe-in of the front tires follow these instructions for both front steering cylinders carefully:

1. Phase the cylinders (page 4.22), stopping at “center” .
2. Loosen jam nut (fig. 6.21-1).
3. Screw swivel assembly in or out on steering cylinder until the measurement from the center of the rod end to the collar (fig. 6.21-1, item 2) is the same on both of the front steering cylinders.
4. Tighten jam nut.
5. Phase cylinders again, re-check toe-in measurement. The cylinders must be phased anytime an adjustment is made to the cylinders.
6. Drive forward 30 to 50 feet and recheck toe-in.
7. Repeat steps 2-6 until a correct toe-in measurement is reached.

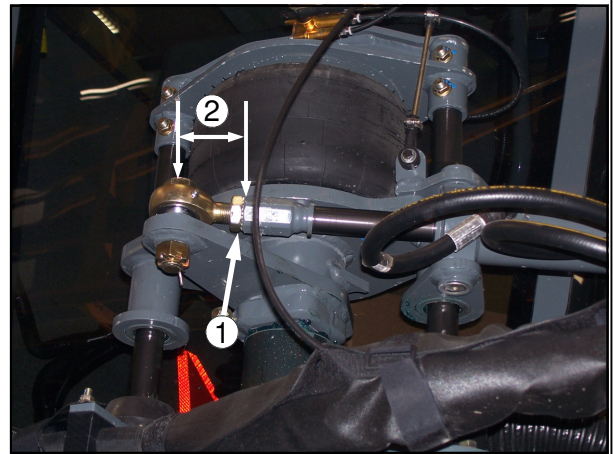

FIG 6.21-1

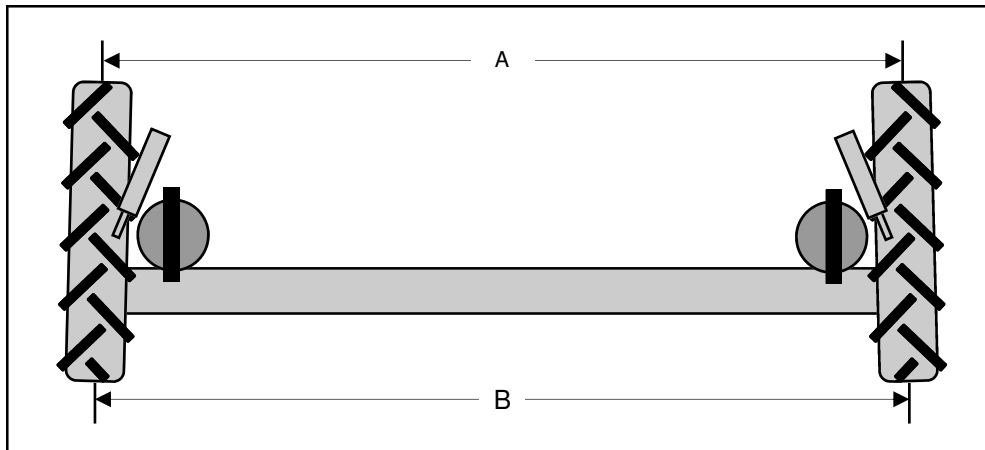

FIG 6.21-2

NOTE:

Dimension “A” should be 1/2” to 3/4” less than dimension “B.” For more information regarding toe-in, see page 6.20.

VI. SERVICE AND MAINTENANCE

I. AIR PRESSURE

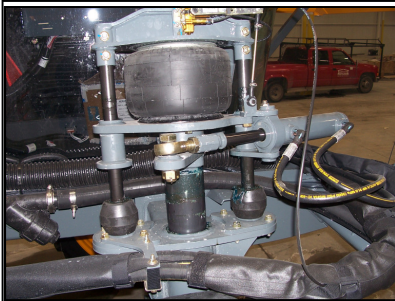

FIG 6.22-1

AIR BAG PRESSURE– The airbags (6.22-1) automatically adjust pressure to compensate for load weight and field conditions.

The system includes an air dryer (fig. 6.22-2) that dries the air coming from the air compressor before sending it to a collection tank. Check the dryer cartridge every 50 hours to make sure that it is purging with compressor unload. Change the cartridge as needed or every other season (1000 hours).



FIG 6.22-2

From the collection tank, the air is sent to the airbags located on the legs (fig. 6.22-1) as needed to maintain a level pressure. There are control valves on each leg that open and close to allow air in.

Visually check the air bags daily for leaks and cracking. If an air bag seems to be low check the bag for any punctures or leaks. Call Hagie Customer Service for repairs.



FIG 6.22-3

WET TANK– Drain the wet tank (fig. 6.22-3) daily to prevent system condensation from contaminating the engine air compressor or dryer.

AIR TANK– Drain the air tank (fig. 6.22-4) daily by slowly releasing the drain cock. Check for moisture in the system.

If there is excessive moisture in this tank, there may be a problem with the system. Call Hagie Customer Support for assistance.

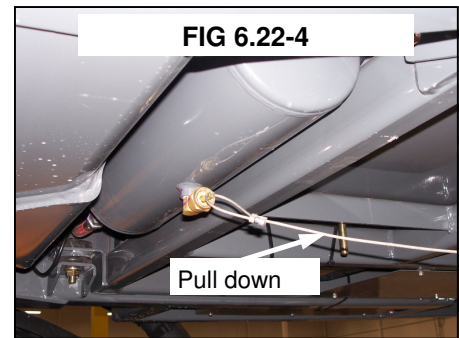

FIG 6.22-4

TIRE PRESSURE– Check the pressure once a week or every 50 hours of operation (fig. 6.22-5). Never inflate a tire more than the recommended maximum air pressure. Use an air line with a locking air chuck and stand behind the tire tread while filling (fig. 6.22-6).



FIG 6.22-5



FIG 6.22-6

NOTE:

Tire pressure will depend on tire type and load quantity in solution tanks. Refer to page 3.6 for tire specifications.



WARNING

When inflating tire use extension hose with in-line air gauge and clip-on air chuck, which allow operator to stand clear of tire side wall explosion trajectory.

VI. SERVICE AND MAINTENANCE

J. SPRAY SYSTEM

SPRAY TIPS— At the beginning of each season, or as required, remove a random sample of spray tip caps (fig. 6.23-3, item 3) and inspect the nozzle tips. If they are plugged or worn, clean or replace them. **DO NOT** put your mouth to a spray tip to try to unplug it!

NOZZLE DIAPHRAGMS— At the beginning of each season, remove each nozzle body cap (fig. 6.23-3, item 1) and inspect the diaphragm (fig. 6.23-3, item 2) for wear or fit. Replace if necessary. Refer to accompanying manual containing nozzle information.

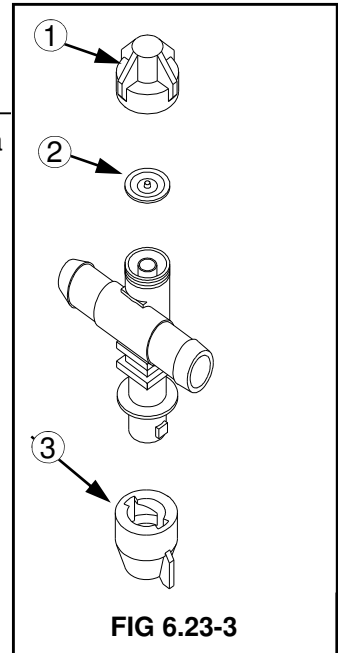

WIPER BLADE— Change the wiper blade as often as necessary. Do not allow the wiper blade to run on a dry windshield as this will shorten the life of the blade or cause scratching of the windshield.

Replace the blade (fig. 6.23-2) with a 39 inch heavy duty blade of your choice.



VII. STORAGE

A. PREPARING FOR STORAGE

1. Perform daily level checks, lubrication, and bolt and linkage inspections as required in this manual in section seven on maintenance.
2. Every other season, drain the coolant from the engine and radiator. Probe the drain holes during draining to ensure they are not clogged by sludge, scale, or other deposits. Fill the cooling system to the top with a 50/50 water/ antifreeze mixture. Run the engine to operating temperature and re-check the level.
3. Add a fuel stabilizer to the fuel and fill the tank.
4. Run the engine until it is at operating temperature, then drain the engine oil. Refill with fresh oil of recommended weight and install a new lubricating oil filter element.
5. With the engine at normal operating temperature, cycle all hydraulic functions including the steering.
6. Release tension on all belts.
7. Use plastic bags and water resistant adhesive tape to seal the air intake opening, all exhaust manifold openings, engine oil filter cap, hydraulic oil tank breather cap, and fuel tank caps.
8. Disconnect and remove batteries. Completely clean and charge the batteries. Coat the terminals with dielectric grease and store the batteries in a cool, above freezing place.
9. Thoroughly clean the sprayer. Touch up any painted surfaces that are scratched or chipped. For touch up paint recommendations contact the Hagie Manufacturing Customer Support Department.
10. Replace worn or missing decals. See Section 1 for proper location of warning decals and their corresponding part number. Warning decals and all other Hagie decals are available through the Hagie Customer Support Department.
11. Use a multi-purpose grease to coat exposed hydraulic cylinder rods.
12. To winterize the spray system, it is recommended that you use an environmentally safe type antifreeze and water mixture that will give you adequate protection to minus 30 degrees below zero. Drain any remaining solution in the spray system and run the antifreeze mixture through the spray system until it comes out all boom openings. Repeat the above process with both the foam marker and rinse systems.
13. Refer to the Raven manual for detailed information on storage procedures for the console and flow meters.
14. If the sprayer must be stored outside, cover it with a waterproof cover.

NOTE:

If antifreeze is added, make sure the engine is then run to operating temperature to assure proper mixing of solution.

NOTE:

For replacement decals contact:
Hagie Manufacturing Company
721 Central Ave. West
Box 273
Clarion, IA 50525-0273
Ph. 1-800-247-4885

VII. STORAGE

B. REMOVING THE SPRAYER FROM STORAGE

1. Inspect the condition, and test the air pressure of all the tires.
2. Carefully unseal all openings that were sealed in the storage process.
3. Clean and reinstall the batteries. Be sure to attach the battery cables to the proper terminals.
4. Tighten all belts. Inspect and replace any worn belts.
5. Check the engine oil, hydraulic oil, and engine coolant levels; add if necessary. A mixture of 50/50 anti-freeze and water will cool adequately in summer as well as protect in winter.
6. Completely clean the sprayer.
7. Review section seven on maintenance and perform all needed services as instructed.
8. For starting instructions, refer to section 4 on operating information.

NOTE:

Protective compounds such as grease can harden under exposure to weather conditions. Be sure to remove any dried grease and re-apply new if necessary.

NOTE:

See Warranty on page 9.1 concerning **improper storage**.

VIII. TROUBLE SHOOTING

A. ENGINE



CAUTION

Start engine from operator's seat only. When running engine in a building, be sure there is adequate ventilation.

PROBLEM	POSSIBLE CAUSE	SUGGESTED REMEDY
Engine won't crank	<ul style="list-style-type: none"> • Dead battery • Poor battery connections • Starter or starter relay • Blown fuse in engine electric box • Battery switch in OFF position 	<ul style="list-style-type: none"> • Recharge or replace battery • Clean and tighten • Test; rebuild or replace • Check 20 amp fuse • Turn battery switch to ON position
Engine won't start	<ul style="list-style-type: none"> • Out of fuel • Clogged fuel filter • Cold weather • Low starter speed • Blown fuse in engine electric box 	<ul style="list-style-type: none"> • Fill fuel tank • Replace fuel filters • Refer to engine manual for cold weather starting • Check starter and battery • Check 20 amp fuse
Engine overheats	<ul style="list-style-type: none"> • Engine overloaded • Dirty radiator core or dirty grill screen • Faulty radiator cap • Loose or faulty fan belt • Faulty thermostat • Low coolant level 	<ul style="list-style-type: none"> • Reduce load • Remove all foreign material and clean all items • Replace cap • Tighten or replace fan belt • Replace thermostat • Refill to proper level with recommended coolant

VIII. TROUBLE SHOOTING

A. ENGINE



Start engine from operator's seat only. When running engine in a building, be sure there is adequate ventilation.

PROBLEM	POSSIBLE CAUSE	SUGGESTED REMEDY
Engine misfires: runs uneven, low power	<ul style="list-style-type: none">• Water in fuel• Dirty air cleaner element• Poor grade of fuel• Fuel tank vent clogged• Clogged fuel filter	<ul style="list-style-type: none">• Drain, flush, replace filter, fill system• Replace element• Drain system, change to a better grade fuel• Open fuel tank vent in cap• Replace fuel filter
Engine knocks	<ul style="list-style-type: none">• Low oil level in crankcase• Cold engine	<ul style="list-style-type: none">• Add oil to full mark• Allow proper warm-up period; refer to engine owner's handbook

VIII. TROUBLE SHOOTING

B. SPRAY SYSTEM



WARNING

CHEMICALS ARE DANGEROUS

Read The Chemical manufacturer's labels to avoid injury or damage.

PROBLEM	POSSIBLE CAUSE	SUGGESTED REMEDY
Solution pump will not prime	<ul style="list-style-type: none"> • Low water level in pump • Air leak in suction line • Solution tank valve closed 	<ul style="list-style-type: none"> • Make sure the solution tank is not empty, solution pump is self-priming • Inspect and tighten all fittings on suction line • Open solution tank valve, allow air to leave the system
Erratic reading on pressure gauge	<ul style="list-style-type: none"> • Orifice in back of gauge clogged • Faulty gauge • Air leak in suction line • Glycerin leaking from gauge 	<ul style="list-style-type: none"> • Remove gauge; clean orifice; reinstall • Replace gauge • Inspect and tighten all fittings in suction line • Replace gauge
Malfunction of electric solution valve	<ul style="list-style-type: none"> • Faulty ground • Dirty contact terminals • Separation in wire • Faulty switch • Short in solenoid coil • Bad valve 	<ul style="list-style-type: none"> • Clean and tighten ground • Clean contact terminals • Check continuity and replace wire • Replace switch • Replace valve • Replace valve

VIII. TROUBLE SHOOTING

B. SPRAY SYSTEM

NOTE:

If your unit is equipped with a high-pressure system, call the Hagie Manufacturing Customer Support Department for possible causes and suggested remedies.

PROBLEM	POSSIBLE CAUSE	SUGGESTED REMEDY
Solution pump not producing normal pressure	<ul style="list-style-type: none"> • Clogged line strainer screen • Air leak in suction flow to pump • Restricted solution flow to pump • Suction hose collapsed • Internal restriction of diaphragm such as build up of chemical • Hydraulic failure 	<ul style="list-style-type: none"> • Remove screen; clean thoroughly; tighten strainer cap to avoid air leak • Inspect and tighten all fittings on suction line • Main solution tank shut-off valve not completely open • Obstruction at inlet end of hose causing high vacuum on hose • Disassemble; inspect; clean; reassemble • Call Hagie Customer Service

NOTE:

Refer to the Raven installation and operation manual for trouble shooting guide on Raven console and system

VIII. TROUBLE SHOOTING

C. HYDROSTATIC SYSTEM



PROBLEM	POSSIBLE CAUSE	SUGGESTED REMEDY
Machine won't move in either direction	<ul style="list-style-type: none"> • Speed control is set too low • Engine speed too low • Oil level in reservoir too low • Clogged filter • Hydrostatic system failure 	<ul style="list-style-type: none"> • Adjust the setting of the speed control knob • Set engine at operating RPM before trying to move machine • Fill reservoir to proper level with approved oil; see section on service and maintenance • Replace filter • Call Hagie Customer Service

VIII. TROUBLE SHOOTING

C. HYDROSTATIC SYSTEM



PROBLEM	POSSIBLE CAUSE	SUGGESTED REMEDY
Machine will move in only one direction	<ul style="list-style-type: none"> • Speed control is set too low • Hydrostatic system failure 	<ul style="list-style-type: none"> • Adjust the setting of the speed control knob • Call Hagie Customer Service
Hydrostatic system responding slowly	<ul style="list-style-type: none"> • Engine speed too low • Oil in reservoir low • Cold oil • Plugged filter • Partially restricted suction line • Hydrostatic system failure 	<ul style="list-style-type: none"> • Set engine at operating RPM before trying to move machine • Fill reservoir to proper level with approved oil; see section on service and maintenance • Allow adequate warm up period • Check and replace filter • Inspect for collapsed suction hose • Call Hagie Customer Service
Noisy hydrostatic system	<ul style="list-style-type: none"> • Cold oil • Low engine speed • Oil level in reservoir low • Hydrostatic system failure 	<ul style="list-style-type: none"> • Allow adequate warm up period • Increase engine speed • Fill reservoir to proper level with approved oil; see section on service and maintenance • Call Hagie Customer Service

VIII. TROUBLE SHOOTING

D. HYDRAULIC SYSTEM

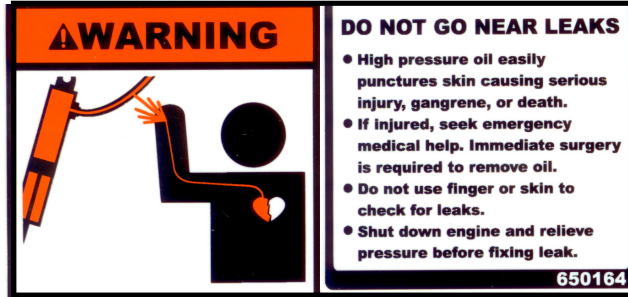

PROBLEM	POSSIBLE CAUSE	SUGGESTED REMEDY
Entire hydraulic system fails to function	<ul style="list-style-type: none"> Oil level in reservoir too low Auxiliary hydraulic system failure 	<ul style="list-style-type: none"> Fill reservoir to proper level with approved oil; see section on service and maintenance Call Hagie Customer Service
Noisy hydraulic pump	<ul style="list-style-type: none"> Oil level in reservoir too low Auxiliary hydraulic system failure 	<ul style="list-style-type: none"> Fill reservoir to proper level with approved oil; see section on service and maintenance Call Hagie Customer Service

NOTE:
Refer to the Raven installation and operation manual for trouble shooting guide on Raven console and system

VIII. TROUBLE SHOOTING

E. ELECTRICAL

 **CAUTION**
 Batteries contain sulfuric acid. Avoid contact with skin, eyes, or clothing. Do not inhale fumes or ingest liquid. Batteries contain gases which can explode. Keep sparks and flame away while servicing.

NOTE:
 Disconnect battery when servicing any part of electrical system to prevent system damage.

PROBLEM	POSSIBLE CAUSE	SUGGESTED REMEDY
Entire electrical system is dead	<ul style="list-style-type: none"> • Dead battery • Poor battery connection • Low charging rate • No charging rate • Battery master switch is in OFF position 	<ul style="list-style-type: none"> • Replace battery • Clean and tighten battery connections • Tighten alternator belt • Replace alternator • Turn battery master switch to ON position
Light system does not function	<ul style="list-style-type: none"> • Poor ground • Burned out bulb • Separation or short in wire • Blown fuse • Faulty switch • Ignition switch is off 	<ul style="list-style-type: none"> • Clean and tighten ground • Replace bulb • Check continuity and replace wire • Replace fuse • Replace switch • Turn ignition switch to ON position

NOTE:
 Refer to the Raven installation and operation manual for trouble shooting guide on Raven console and system

VIII. TROUBLE SHOOTING

NOTES

IX. LIMITED WARRANTY

Hagie Manufacturing Company Product Warranty

Hagie Manufacturing Company warrants each new Hagie (including Vammas by Hagie) product to be free under normal use and service from defects in workmanship and materials for a period of lesser of: two (2) years or 1000 hours from the date of delivery on all Agricultural Products and two (2) years or 2000 hours on all Vammas By Hagie Snow Removal Equipment (SRE). Hagie Manufacturing Company makes this warranty from the original delivery date and is transferable to a purchaser from the original purchaser of this equipment, given there is remaining time left under the year and hour warranty standard stated above. This warranty shall be fulfilled by repairing or replacing free of charge any part that shows evidence of defect or improper workmanship, provided the part is returned to Hagie Manufacturing Company within thirty (30) days of the date that such defect or improper workmanship is discovered, or should have been discovered. Labor to repair said items will be covered by standard labor time rates. Freight charges of defective parts are not covered by this warranty and are the responsibility of the purchaser. No other express warranty is given and no affirmation of Hagie Manufacturing Company, by words or action, shall constitute a warranty.

Hagie Manufacturing Company limits its warranty to only those products manufactured by Hagie Manufacturing Company (including Vammas by Hagie) and does not warrant any part or component not manufactured by Hagie Manufacturing Company (including Vammas by Hagie), such as parts or components being subject to their manufacturer's warranties, if any. Excluded from this warranty are parts subjected to accident, alteration, or negligent use or repair. This warranty does not cover normal maintenance such as engine tune ups, adjustments, inspections, nor any consumables such as tires, rubber products, solution system valves, wear parts, wiper blades, etc.

Hagie Manufacturing Company shall not be responsible for repairs or replacements which are necessitated, in whole or in part; by the use of parts not manufactured by or obtainable from Hagie Manufacturing Company nor for service performed by someone other than Hagie authorized personnel, unless authorized by Hagie Manufacturing Company. Customer acknowledges that it is not relying on Hagie Manufacturing Company's skill or judgment to select finish goods for any purpose and that there are no warranties which are not contained in this agreement.

In no event shall Hagie Manufacturing Company's tort, contract, or warranty liability exceed the purchase price of the product. The foregoing limitation will not apply to claims for personal injury caused solely by Hagie Manufacturing Company's negligence.

Hagie Manufacturing Company shall not be liable for damages, including special, incidental or consequential damages or injuries (damage and repairs of equipment itself, loss of profits, rental or substitute equipment, loss of good will, etc.) arising out of or in connection with performance of the equipment or its use by customer, and Hagie Manufacturing Company shall not be liable for any special, incidental or consequential damages arising out of or in connection with Hagie Manufacturing Company's failure to perform its obligation hereunder. HAGIE MANUFACTURING COMPANY'S ENTIRE LIABILITY AND THE CUSTOMER'S EXCLUSIVE REMEDY SHALL BE REPAIR OR REPLACEMENT OF PARTS COVERED UNDER THIS WARRANTY. THIS WARRANTY IN LIEU OF ALL OTHER WARRANTIES, EXPRESSED OR IMPLIED, INCLUDING, BUT NOT LIMITED TO THE IMPLIED WARRANTY OF MERCHANTABILITY OR FITNESS FOR A PARTICULAR PURPOSE.

NOTES
