

LS475 Liquid System Application (North American Edition)



CALIFORNIA Proposition 65 Warning

Diesel engine exhaust and some of its constituents are known to the State of California to cause cancer, birth defects, and other reproductive harm.

If this product contains a gasoline engine:

WARNING

The engine exhaust from this product contains chemicals known to the State of California to cause cancer, birth defects, or other reproductive harm.

OPERATOR'S MANUAL LS475 LIQUID SYSTEM APPLICATION (NORTH AMERICAN EDITION) 493885 REV A (ENGLISH)

Hagie Manufacturing Company, LLC
North American, Printed in U.S.A

Original instructions. All information, illustrations, and specifications in this manual are based on the latest information available at the time of publication. The right is reserved to make changes at any time without notice.



HAGIE
CONTENTS

1 – INTRODUCTION

Foreword	1-1
Pre-Delivery	1-2
Delivery	1-2
After-Sale	1-3
Owner Register	1-3
Service and Assistance	1-3

2 – SAFETY

Recognize Safety Information	2-1
Understand Signal Words	2-1
Follow Safety Instructions	2-1
Prepare For Emergencies	2-2
Wear Protective Clothing	2-2
Protect Against Noise	2-2
Practice Safe Maintenance	2-2
Park Machine Safely	2-3
Remove Paint Before Welding or Heating	2-3
Avoid Heating Near Pressurized Fluid Lines	2-3
Avoid High-Pressure Fluids	2-4
Decommissioning - Proper Recycling and Disposal of Fluids and Components	2-4
Handle Chemical Products Safely	2-5
Service Application Equipment Safely	2-5
Use Proper Tools	2-5
Work in Ventilated Area	2-6
Handle Batteries Safely	2-6
Service Drive Belts Safely	2-7
Use Compressed Air For Cleaning	2-7
Maintain a Safe Area Around the Machine	2-7
Working Area	2-7
Avoid Backover Accidents	2-7
Before Operating	2-8
Operate Safely	2-8
Avoid Injury From Dispensed Objects	2-8
Use Safety Lights and Devices	2-9
Keep Riders off Machine	2-9
Instructional Seat	2-9
Use Steps and Handholds Correctly	2-9
Use Seat Belt Properly	2-10
Use Caution on Hillsides	2-10
Transport and Operate Safely	2-10

Prevent Machine Runaway	2-10
Handle Fuel Safely - Avoid Fires	2-11
Handle Agricultural Chemicals Safely	2-11
Avoid Exposure to Chemicals	2-12
Clean Vehicle of Hazardous Chemicals, Including Pesticides	2-13
Non-Permissible Use	2-13
Emergency Exit	2-13

3 – SAFETY SIGNS

Replace Safety Signs	3-1
Rinse Tank Decal	3-1
Hand Wash Tank Decal	3-1
Chemical Exposure Decal	3-1
Charge Port Decal	3-2
Hydraulic Oil Under Pressure Decal	3-2
Electrical Power Lines Decal	3-2
Do Not Enter Solution Tank Decal	3-2
Chemical Hazard Decal	3-2
Do Not Pressure Wash Decal	3-3
Transport Decal	3-3

4 – SAFETY FEATURES

5 – BOOMS

Access Boom and Nozzles	5-1
Boom and Nozzles Main Page	5-1
Boom Sections Custom	5-3
Working Width	5-4
Specific Gravity	5-4
Nozzle Setup	5-5
NORAC®	5-6
Re-Engage NORAC® Through Multi-Function Lever	5-9
Section Setup	5-13
Nozzle Spacing Layout - 60”(152.4 cm) / 30”(76.2 cm)	5-14

6 – CALIBRATIONS

Access Calibrations and Procedures	6-1
Calibrations and Procedures Overview	6-1
Boom Maintenance Mode	6-2
Nozzle Flow Check	6-3
Boom Calibration Auto Boom Fold/Unfold	6-6
Boom Calibration Center Frame Position	6-9
Boom Calibration Level Position	6-10
Boom Calibration Tilt Sensors	6-11
Boom Calibration Tilt Valves	6-13
Reset Calibrations Boom Calibrations	6-15
Spray Calibration Flow Meters	6-15

Spray Calibration Pressure Sensors	6-16
Spray Calibration Solution Pumps	6-18
Reset Calibrations Spray Calibrations	6-19

7 – RINSE SYSTEM

Access Rinse System	7-1
Rinse System Main Page	7-1
Rinse System (Boom Only)	7-2
Rinse System (Solution System)	7-4
Rinse System (Solution Tank Only)	7-6
Rinse System (Rinse Tank Transfer)	7-8

8 – LIQUID SYSTEM

Access Liquid Application System	8-1
Spray System Main Page	8-1
Minimum Pressure	8-3
Target Rate/Rx	8-4
Flow Rate Mode	8-5
Flow Recommendations	8-6
Spray Off Pressure	8-7
Pressure Relief	8-8
Advanced Settings	8-9

9 – TANK SYSTEM

Access Tank System	9-1
Tank System Main Page	9-1
Tank Fill Preset	9-3
Current Tank Volume	9-3
Low Tank Alarm	9-4
Target Fill	9-4
Agitation	9-5
Eductor Level	9-6

10 – OPERATE LIQUID SYSTEM

Service and Operate Chemical Sprayers Safely	10-1
Avoid Exposure to Chemicals	10-1
Prepare for Field Operation	10-2
Field Operation	10-3
Operate Indexed Boom Sections (IBS)	10-5

11 – WET SYSTEM

Service and Operate Chemical Sprayers Safely	11-1
Avoid Exposure to Chemicals	11-1
Avoid Contact with Chemicals, Including Pesticides	11-2
Solution System Schematic	11-3
Solution System - Overview	11-3
Solution Command System Panel	11-5

Solution Tank	11-6
Solution Tank Fill Opening	11-7
Liquid Level Indicator (Solution Tank)	11-7
Solution Tank Level Pressure Sensor	11-7
Agitation	11-8
Chemical Eductor	11-8
Chemical Eductor - Rinsing Empty Containers	11-10
Chemical Eductor Rinse	11-11
Pressure and Flow Measurement	11-11
Electric Boom Section Valves	11-12
Hand Wash Tank	11-12
Rinse Water Tank	11-13
Solution Tank Rinse Nozzles	11-14
Solution Tank Filling	11-14
Solution Tank Draining	11-16
Rinse Tank Filling	11-16
Rinse Tank Draining	11-18
Solution Pumps	11-19
Solution Pump Recommendations	11-19
Agitation of Solution Tank Contents	11-19
Rinse System - System Rinse/Boom Rinse	11-19
High-Pressure Washer	11-21
Solution Pump Maintenance and Operation Recommendations	11-22
Troubleshooting	11-23
Replace Nozzles	11-24
Spray Tip Types	11-24
Flat Fan Spray Tip	11-25
Straight Stream Ceramic Spray Tip	11-25
Flat Fan High-Flow (Flood) Spray Tip	11-26
Use Spray Tip Calculator and Selector	11-26
Check and Replace Worn Nozzles	11-28
27.4 M (90 ft) Boom Flow Characteristics - Application Rate vs. Speed	11-28
Boom Spray Width	11-29
Nozzle Calibration	11-29
Calibration Procedure	11-29
Conversion Factors (Calibrating For Carriers Other Than Water)	11-30
Install and Position Nozzle Tips and Strainers	11-30
Standard Factory Equipment	11-31
Clean SprayMaster™ 5-Position Nozzle Bodies - Standard Flow	11-32
Solution Strainers	11-33
Eliminating Air from Solution System	11-33
Troubleshooting Nozzles that Drip, Leak, or Seep After Valve is Shut Off	11-34
Spray Pipe Aspirators	11-34
Boom Supply Air Bleed	11-34

12 – 27.4 M (90 FT) BOOMS

Boom Unfold/Fold - 27.4 m (90 ft) Booms	12-1
Spray with Boom at 18.3 m (60 ft)	12-5
Full Boom Breakaway	12-5
Adjust Breakaway Section Springs	12-5
Adjust Outer Boom Section Stop Bolt	12-6
Adjust Breakaway Stop	12-6
Adjust Outer Fold Cylinder	12-6
Adjust Inner Fold Cylinder	12-8
Adjust Outer Wing Rest	12-9

13 – LIQUID SYSTEM REMOVAL/INSTALLATION

Liquid System Removal and Installation	13-1
--	------

14 – LUBRICATION AND MAINTENANCE

Clean Vehicle of Hazardous Chemicals, Including Pesticides	14-1
Prevent Hydraulic System Contamination	14-1
Dispose of Waste Properly	14-1
Service Intervals	14-2
Check Hydraulic Oil Level - Daily	14-3
Clean Oil Cooler - Daily	14-3
Lubricate Boom Lift Arm Pins - Daily	14-4
Clean Solution Strainers - Daily	14-4
Clean Aspirators, Nozzle Bodies, and Tips - As Required	14-6
Check Solution Tank Straps - As Required	14-7
Solution System Cleaning - 25 Hours	14-7
Inspect Hydraulic Hoses - 50 Hours	14-8
Inspect Liquid System and Boom Structure - 200 Hours	14-9
Change Hydraulic Oil - 1000 Hours	14-9
Inspect Hydraulic Relief Valves - 1000 Hours	14-11
Inspect Boom Pivot Bushings - Annually	14-11
Clean Sprayer and Coat Exposed Surfaces - Annually	14-11

15 – LUBRICANT SPECIFICATIONS

Transmission and Hydraulic Oil	15-1
Multipurpose Extreme Pressure (EP) Grease	15-1

16 – STORAGE

Avoid Exposure to Chemicals	16-1
Service and Operate Chemical Sprayers Safely	16-2
Clean Vehicle of Hazardous Chemicals, Including Pesticides	16-2
Recommended Cleaners and Coatings	16-3
Prepare Machine for Storage	16-3
Remove Machine from Storage	16-3

17 – SPECIFICATIONS

Specifications	17-1
----------------------	------

Dimensions	17-3
Unified Inch Bolt and Screw Torque Values	17-6
Metric Bolt and Screw Torque Values	17-7
Face Seal Fittings Assembly and Installation - All Pressure Applications	17-8
Metric Face Seal and O-Ring Stud End Fitting Torque Values	17-9
Metric Face Seal and O-Ring Stud End Fitting Torque Values	17-10
SAE Face Seal and O-Ring Stud End Fitting Torque Values	17-12
SAE Face Seal and O-Ring Stud End Fitting Torque Values	17-13
Four Bolt Flange Fittings Assembly and Installation - All Pressure Applications	17-14
SAE Four Bolt Flange Cap Screw Torque Values	17-14
SAE Four Bolt Flange Cap Screw Torque Values	17-15
External Hexagon Port Plug Torque Values	17-16



SECTION 1 – INTRODUCTION

Foreword



READ THIS MANUAL carefully to learn how to operate and service your machine correctly. Failure to do so could result in personal injury or equipment damage. This manual and safety signs on your machine may also be available in other languages. See your John Deere dealer to order.

THIS MANUAL SHOULD BE CONSIDERED a permanent part of your machine and should remain with the Liquid System when you sell it.

MEASUREMENTS in this manual are given in both metric and customary U.S. unit equivalents. Use only correct replacement parts and fasteners. Metric and inch fasteners may require a specific metric or inch wrench.

RIGHT-HAND and LEFT-HAND sides are determined by facing in the direction of forward travel.

WRITE PRODUCT IDENTIFICATION NUMBERS (PIN) in the Specification or Identification Numbers section. Accurately record all the numbers to help in tracing the machine should it be stolen. Your dealer also needs these numbers when you order parts. File the identification numbers in a secure place off the machine.

WARRANTY is provided as part of the Hagie support program for customers who operate and maintain their equipment as

described in this manual. The warranty is explained on the warranty certificate which you should have received from your dealer.

This warranty provides you the assurance that Hagie backs its products where defects appear within the warranty period. In some circumstances, Hagie also provides field improvements, often without charge to the customer, even if the product is out of warranty. If the equipment is abused, or modified to change its performance beyond the original factory specifications, the warranty becomes void and field improvements can be denied. Installing an unauthorized application system, or modifying the Hagie-authorized Liquid System to exceed design weight limitations also voids warranty.

The LS475 has been constructed for the application of crop protection chemicals in ground cultivation and agriculture (“Intended Use”). The application of crop protection chemicals must be done according to the manufacturers’ instructions and legal user regulations. Intended Use also implies the observance of all use and maintenance instructions prescribed by the manufacturer. Any other use is regarded as non-compliant with its purpose, including:

SECTION 1 – INTRODUCTION



- Improper use of agrochemicals (herbicides, fungicides, insecticides, and growth regulators)
- Non-compliance with instructions issued by the manufacturers or fertilizer and crop protection chemicals
- Non-compliance with legal requirements applicable to the use of fertilizers and crop protection chemicals, including their combination with other chemicals

THE LS475 MUST ONLY be used and serviced by authorized persons who are informed about the hazards and correct operation of the system. The relevant safety regulations and all other accepted safety, technical, medical, and traffic instructions must be observed.

If you are not the original owner of this machine, it is in your interest to contact your local John Deere dealer to inform them of this unit's serial number. The serial number helps John Deere notify you of any issues or product improvements.

Pre-Delivery

After the machine has been assembled, inspect to verify that it is in good running order before delivering to the customer. The following checklist is a reminder of points to inspect. Check off each item as it is found satisfactory or after proper adjustment is made.

- SMV emblem and reflectors installed.
- Verify all safety decals are in place (see Safety Signs section in this manual for decal locations).
- Verify correct speed limit decal is installed for your location.
- All fluid levels have been checked.
- All grease fittings have been lubricated.
- Tires are properly inflated.
- Tighten wheel bolts to specified torque.
- Hydraulic systems operate properly and do not leak.
- Any parts scratched in shipment have been touched up with paint.

- Factory made entries in the Gen4 display have been confirmed and/or reset to agree with calibration values.
- All mandatory open Product Improvement Programs (PIP) should be completed before delivering the machine to the customer.

This machine has been thoroughly checked and to the best of my knowledge is ready for delivery to the customer.

Signed: _____

Date: _____

Delivery

At the time the machine is delivered, the following checklist is a reminder of information which should be conveyed directly to the customer. Check off each item as it is fully explained to the customer.

- Tell the customer to use the proper tools.
- Explain to the customer that the life expectancy of this or any other machine depends on regular lubrication as directed in the operator's manual.
- Give the operator's manual to the customer and explain all operating adjustments.
- Make the customer aware of all the safety precautions that must be exercised while using this machine.
- When the machine is transported on a road or highway, lights or devices must be used for an adequate warning to operators of other vehicles. In this regard, tell the customer to check local governmental regulations.

To the best of my knowledge, this machine has been delivered ready for field use. The customer has been fully informed as to proper care and operation.

Signed: _____

Date: _____

After-Sale

The following is a suggested list of items to be checked at a dealer-customer meeting during the first operating season, usually after 50 to 100 hours of operation.

- Check with the customer as to the performance of the machine. Make certain the proper operating adjustments are understood.
- If possible, operate the machine to see that it is functioning properly.
- Go over the entire machine for loose or missing hardware.
- Check for broken or damaged parts.
- Ask the customer if the recommended periodic lubrication has been performed.
- Review the operator's manual with the customer and stress the importance of proper lubrication and safety precautions.

Signed: _____

Date: _____

Owner Register

Name: _____

Address: _____

City: _____

State: _____

Model
Number: _____

Serial
Number: _____

Date
Purchased: _____

Service and Assistance



John Deere Is At Your Service

Customer satisfaction is important to Hagie and John Deere. Our dealers strive to provide you with prompt, efficient parts and service:

- Maintenance and service parts to support your equipment.
- Trained service technicians and the necessary diagnostic and repair tools to service your equipment.

Customer Satisfaction Problem Resolution Process

Your John Deere dealer is dedicated to supporting your equipment and resolving any problem you may experience.

1. When contacting your dealer, be prepared with the following information:
 - Machine model and product identifica-

SECTION 1 – INTRODUCTION



- tion number.
- Date of purchase.
 - Nature of problem.
2. Discuss problem with dealer service manager.
 3. If unable to resolve, explain problem to dealership manager and request assistance.
 4. If you have a persistent problem your dealership is unable to resolve, ask your dealer to contact John Deere for assistance, or contact the Ag Customer Assistance Center at 1-866-99DEERE (866-993-3373) or e-mail us at www.deere.com/en_US/ag/contactus.
-



SECTION 2 – SAFETY

Recognize Safety Information



This is a safety alert symbol. When you see this symbol on your machine or in this manual, be alert to the potential for personal injury. Follow recommended precautions and safe operating practices.

Understand Signal Words

 **DANGER**

 **WARNING**

 **CAUTION**

DANGER - The signal word DANGER indicates a hazardous situation which, if not avoided, will result in death or serious injury.

WARNING - The signal word WARNING indicates a hazardous situation which, if not avoided, could result in death or serious injury.

CAUTION - The signal word CAUTION indicates a hazardous situation which, if not avoided, could result in minor or moderate injury. CAUTION may also be used to alert against unsafe practices associated with events which could lead to personal injury.

A signal word - DANGER, WARNING, or CAUTION is used with the safety alert symbol. DANGER identifies the most serious hazards. DANGER or WARNING safety signs are located near specific hazards.

General precautions are listed on CAUTION safety signs. CAUTION also calls attention to safety messages in this manual.

Follow Safety Instructions



Carefully read all safety messages in this manual and on your machine safety signs. Keep safety signs in good condition. Replace missing or damaged safety signs. Be sure new equipment components and repair parts include the current safety signs. Replacement safety signs are available from your John Deere dealer.

There can be additional safety information contained on parts and components sourced from suppliers that is not reproduced in this operator's manual.

Learn how to operate the machine and how to use controls properly. Do not let anyone operate without instruction.

Keep your machine in proper working condition. Unauthorized modifications to the machine may impair the function and/or safety and affect machine life.

If you do not understand any part of this manual and need assistance, contact your John Deere dealer.

Prepare For Emergencies

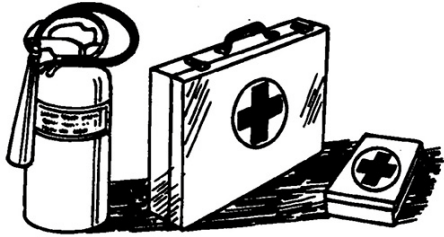

- Be prepared if a fire starts.
- Keep a first aid kit and fire extinguisher handy.
- Keep emergency numbers for doctors, ambulance service, hospital, and fire department nearby.

- There are many variables that affect the sound level range, including machine configuration, condition and maintenance level of the machine, ground surface, operating environment, duty cycles, ambient noise, and attachments.
- Exposure to loud noise can cause impairment or loss of hearing.
- Always wear hearing protection. Wear a suitable hearing protective device such as earmuffs or earplugs to protect against objectionable or uncomfortable loud noises.

Wear Protective Clothing

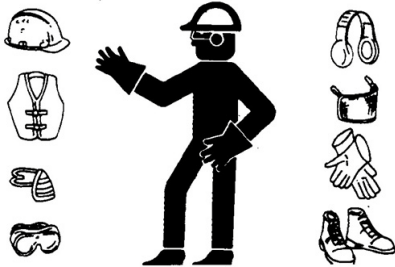

- Wear close fitting clothing and safety equipment appropriate to the job.
- Operating equipment safely requires the full attention of the operator. Do not wear radio or music headphones while operating machine.

Practice Safe Maintenance



- Understand service procedure before doing work. Keep area clean and dry.
- Never lubricate, service, or adjust machine while it is moving. Keep hands, feet, and clothing away from power-driven parts. Disengage all power and operate controls to relieve pressure. Lower equipment to the ground. Stop the engine. Remove the key. Allow machine to cool.
- Securely support any machine elements that must be raised for service work.
- Keep all parts in good condition and properly installed. Fix damage immediately. Replace worn or broken parts. Remove any buildup of grease, oil, or debris.
- On self-propelled equipment, disconnect battery ground cable (-) before making adjustments on electrical systems or welding on machine.

Protect Against Noise



- On towed implements, disconnect wiring harnesses from tractor before servicing electrical system components or welding on machine.
- Falling while cleaning or working at height can cause serious injury. Use a ladder or platform to easily reach each location. Use sturdy and secure footholds and handholds.

Park Machine Safely

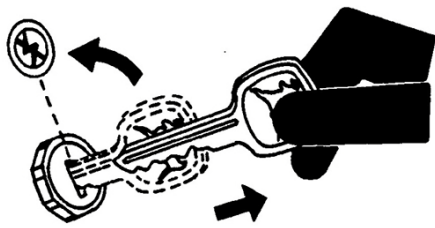

Before working on the machine:

- Lower all equipment to the ground.
- Park machine on a level surface.
- Stop the engine and remove the key.
- Hang a “DO NOT OPERATE” tag in the operator’s station.
- Disconnect the battery ground strap.
- Wait until all moving parts have stopped.

Remove Paint Before Welding or Heating

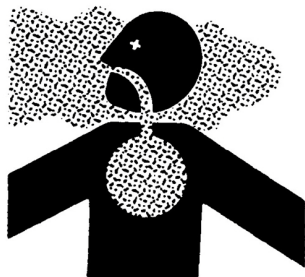

Avoid potentially toxic fumes and dust. Hazardous fumes can be generated when paint is heated by welding, soldering, or using a torch.

Remove paint before heating:

- Remove paint a minimum of 100 mm (4 in) from area to be affected by heating. If paint cannot be removed, wear an approved respirator before heating or welding.
- If you sand or grind paint, avoid breathing the dust. Wear an approved respirator.
- If you use solvent or paint stripper, remove stripper with soap and water before welding. Remove solvent or paint stripper containers and other flammable material from area. Allow fumes to disperse at least 15 minutes before welding or heating.
- Do not use a chlorinated solvent in areas where welding will take place.
- Do all work in an area that is well ventilated to carry toxic fumes and dust away.
- Dispose of paint and solvent properly.

Avoid Heating Near Pressurized Fluid Lines



Flammable spray can be generated by heating near pressurized fluid lines, resulting in severe burns to yourself and bystanders. Do not heat by welding, soldering, or using a torch near pressurized fluid lines or other flammable materials. Pressurized lines can accidentally burst when heat goes beyond the immediate flame area.

Avoid High-Pressure Fluids

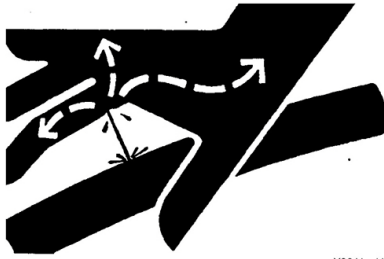

- Inspect hydraulic hoses periodically - at least once per year - for leakage, kinking, cuts, cracks, abrasion, blisters, corrosion, exposed wire braid, or any other signs of wear or damage.
- Replace worn or damaged hose assemblies immediately with Hagie-approved replacement parts.
- Escaping fluid under pressure can penetrate the skin causing serious injury.
- Avoid the hazard by relieving pressure before disconnecting hydraulic or other lines. Tighten all connections before applying pressure.
- Search for leaks with a piece of cardboard. Protect hands and body from high-pressure fluids.
- If an accident occurs, see a doctor immediately. Any fluid injected into the skin must be surgically removed within a few hours or gangrene may result. Doctors unfamiliar with this type of injury should reference a knowledgeable medical source. Such information is available in English from Deere & Company Medical Department in Moline, Illinois, U.S.A., by calling 1-800-822-8262 or +1 309-748-5636.

Decommissioning - Proper Recycling and Disposal of Fluids and Components

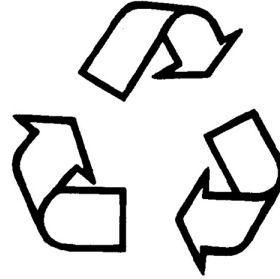

Safety and environmental stewardship measures must be taken into account when decommissioning a machine and/or components. These measures include the following:

- Use appropriate tools and personal protective equipment such as clothing, gloves, face shields, or glasses during the removal or handling of objects and materials.
- Follow instructions for specialized components.
- Release stored energy by lowering suspended machine elements, relaxing springs, disconnecting the battery or other electrical power, and releasing pressure in hydraulic components, accumulators, and other similar systems.
- Minimize exposure to components which may have residue from agricultural chemicals, such as fertilizers and pesticides. Handle and dispose of these components appropriately.
- Carefully drain engines, fuel tanks, radiators, hydraulic cylinders, reservoirs, and lines before recycling components. Use leak-proof containers when draining fluids. Do not use food or beverage containers.
- Do not pour waste fluids onto the ground, down a drain, or into any water source.
- Observe all national, state, and local laws, regulations, or ordinances governing the handling or disposal of waste fluids (example: oil, fuel, coolant, brake fluid); filters; batteries; and, other substances or

parts. Burning of flammable fluids or components in other than specially designed incinerators may be prohibited by law and could result in exposure to harmful fumes or ashes.

- Service and dispose of air conditioning systems appropriately. Government regulations may require a certified service center to recover and recycle air conditioning refrigerants, which could damage the atmosphere if allowed to escape.
- Evaluate recycling options for tires, metal, plastic, glass, rubber, and electronic components, which may be recyclable, in part or completely.
- Contact your local environmental or recycling center or your John Deere dealer for information on the proper way to recycle or dispose of waste.

Handle Chemical Products Safely



Direct exposure to hazardous chemicals can cause serious injury. Potentially hazardous chemicals used with Hagie equipment include such items as lubricants, coolants, paints, and adhesives.

A Material Safety Data Sheet (MSDS) provides specific details on chemical products: physical and health hazards, safety procedures, and emergency response techniques.

Check the MSDS before you start any job using a hazardous chemical. That way you will know exactly what the risks are and how to do the job safely. Then follow procedures and recommended equipment.

See your John Deere dealer for MSDS's on chemical products used with Hagie equipment.

Service Application Equipment Safely

CAUTION

Treat all chemicals with great caution. DO NOT take chances. When in doubt, proceed as though contamination is present.

Before performing any service activity:

- Wear appropriate personal protective equipment (see “Handle Agricultural Chemicals Safely” in this section).
- Clean vehicle (see “Clean Vehicle of Hazardous Chemicals, Including Pesticides” in this section).

Use Proper Tools



- Use tools appropriate to the work. Makeshift tools and procedures can create safety hazards.
- Use power tools only to loosen threaded parts and fasteners.
- For loosening and tightening hardware, use the correct size tools. DO NOT use U.S. measurement tools on metric fasteners. Avoid bodily injury caused by slipping wrenches.

- Use only service parts meeting Hagie specifications.

Work in Ventilated Area



- Engine exhaust fumes can cause sickness or death. If it is necessary to run an engine in an enclosed area, remove the exhaust fumes from the area with an exhaust pipe extension.
- If you do not have an exhaust pipe extension, open the doors and get outside air into the area.

Handle Batteries Safely

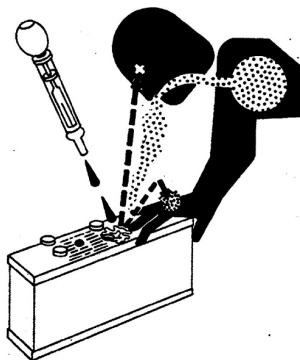

Battery gas can explode. Keep sparks and flames away from batteries. Use a flashlight to check battery electrolyte level.

Never check battery charge by placing a metal object across the posts. Use a voltmeter or hydrometer.

Always remove grounded (-) battery clamp first and replace grounded clamp last.

Sulfuric acid in battery electrolyte is poisonous and strong enough to burn skin, eat holes in clothing, and cause blindness if splashed into eyes.

Avoid hazards by:

- Filling batteries in a well-ventilated area
- Wearing eye protection and rubber gloves
- Avoiding use of air pressure to clean batteries
- Avoiding breathing fumes when electrolyte is added
- Avoiding spilling or dripping electrolyte
- Using correct battery booster or charger procedure

If acid is spilled on skin or in eyes:

1. Flush skin with water.
2. Apply baking soda or lime to help neutralize the acid.
3. Flush eyes with water for 15-30 minutes. Get medical attention immediately.

If acid is swallowed:

1. Do NOT induce vomiting.
2. Drink large amounts of water or milk, but do not exceed 2 L (2 qt).
3. Get medical attention immediately.

WARNING

Battery posts, terminals, and related accessories contain lead and lead compounds, chemicals known to the State of California to cause cancer and reproductive harm. **Wash hands after handling.**

Service Drive Belts Safely

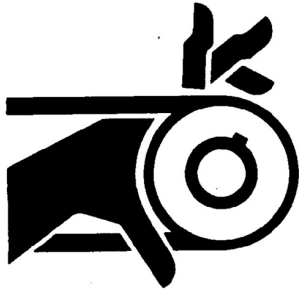

When servicing drive belts, always observe these precautions:

- Avoid serious injury from hand or arm entanglement. Never attempt to clean, check, or adjust belts while the machine is running. Always shut off the engine, set the parking brake, and remove the key.
- Do not attempt to clean belts with flammable cleaning solvents.

Use Compressed Air For Cleaning

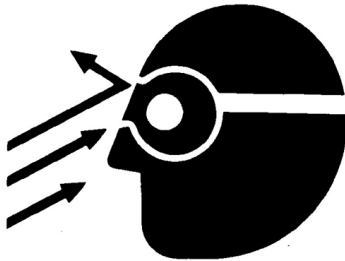

⚠ CAUTION

Reduce compressed air to 210 kPa (2 bar) (30 psi) or less when using for cleaning purposes. Clear area of bystanders, guard against flying debris, and wear personal protective equipment, including eye protection.

Maintain a Safe Area Around the Machine

Machine movements and parts in motion can cause serious injury. Product cannot be completely shielded due to application. Keep away from the application system while it is engaged.

Working Area

The working area is defined and required as follows:

- An area of 1 m (3.3 ft) around the machine for servicing the machine, filling product, and cleaning the application system.
- The seat on the machine from where the crop protection work is carried out.

Danger zones are taken to mean:

- The working area of the operator in which servicing the machine, filling product, and cleaning the machine takes place.
- The maneuvering zone of the machine, in particular a 1m (3.3 ft) zone around the machine as a whole and the application area.

Avoid Backover Accidents



Before moving machine, be sure that all persons are clear of machine path. Turn around and look directly for best visibility. Use a signal person when backing if view is obstructed or when in close quarters.

Do not rely on a camera to determine if personnel or obstacles are behind the machine. The system can be limited by many factors, including maintenance practices, environmental conditions, and operating range.

Before Operating

- Become familiar with operator's manual, machine decals, and Safety section of this manual.
- Remove foreign objects from machine.
- Become familiar with all controls effecting machine functions.
- Make sure everyone is clear of the machine. Never allow riders on the machine or near machine while it is running.
- Inspect machine for loose, missing, or damaged hardware and parts. Replace any missing or damaged parts with proper specification items.
- Verify shields and guards are in place and in good condition before starting.

Operate Safely

- Always check general operating safety of the machine before using.
- Before operating machine, always check immediate vicinity of machine for people and obstructions. Ensure adequate visibility.
- Operate vehicle only when all guards are fitted and in their correct position.
- DO NOT start engine with speed control lever engaged.
- DO NOT operate close to a ditch or creek.
- DO NOT fold or unfold boom near overhead wires.

- Avoid distractions such as reading, eating, or operating personal electronics that take your attention away while operating the unit.
- Always come to a complete stop before reversing directions.
- Drive slowly over rough ground.
- Slow down when turning.
- Always shut off engine when leaving machine. Remove key when leaving machine unattended. Parking brake will engage when engine is turned off, regardless of speed control lever position.
- Keep hands, feet, and clothing away from moving parts.
- Wear relatively tight and belted clothing to prevent from being caught on some part of the machine.

Avoid Injury From Dispensed Objects



Extreme care must be exercised to avoid injury from dispensed objects. Do not, under any circumstances, operate the application hydraulics when other people are in the vicinity. Stay out of discharge area.

Use Safety Lights and Devices

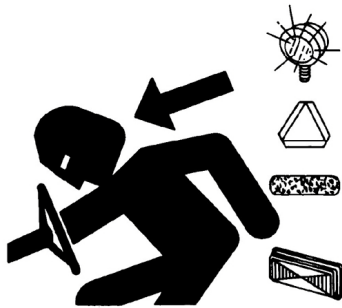

Prevent collisions between other road users, slow moving tractors with attachments or towed equipment, and self-propelled machines on public roads. Frequently check for traffic from the rear, especially in turns, and use turn signal lights.

Use headlights, flashing warning lights, and turn signals day or night. Follow local regulations for equipment lighting and marking. Keep lighting and marking visible, clean, and in good working order. Replace or repair lighting and marking that has been damaged or lost. An implement safety lighting kit is available from your John Deere dealer.

Keep Riders off Machine

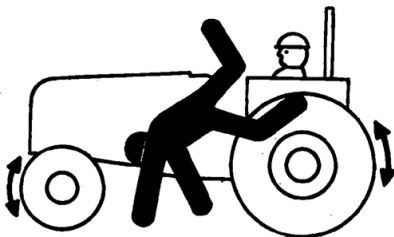

Only allow the operator on the machine. Keep riders off. Riders on machine are subject to injury such as being struck by foreign objects and being thrown off of the machine. Riders also obstruct the operator's view, resulting in the machine being operated in an unsafe manner.

Instructional Seat



The instructional seat has been provided only for training operators or diagnosing machine problems.

Use Steps and Handholds Correctly

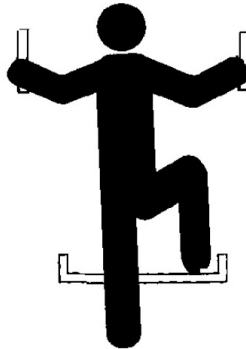

Prevent falls by facing the machine when getting on and off. Maintain 3-point contact with steps, handholds, and handrails.

Use extra care when mud, snow, or moisture present slippery conditions. Keep steps clean and free of grease or oil. Never jump when exiting machine. Never mount or dismount a moving machine.

Use Seat Belt Properly

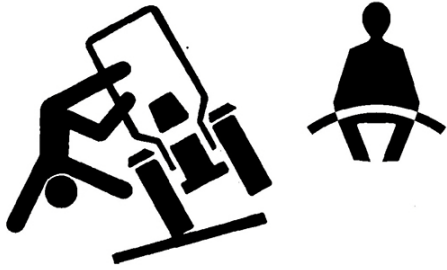

Avoid crushing injury or death during rollover.

- Hold the latch and pull the seat belt across the body.
- Insert the latch into the buckle. Listen for a click.
- Tug on the seat belt latch to make sure that the belt is securely fastened.
- Snug the seat belt across the hips.

Replace entire seat belt if mounting hardware, buckle, belt, or retractor shows signs of damage.

Inspect seat belt and mounting hardware at least once a year. Look for signs of loose hardware or belt damage, such as cuts, fraying, extreme or unusual wear, discoloration, or abrasion. Replace only with replacement parts approved for your machine. See your John Deere dealer.

Use Caution on Hillsides

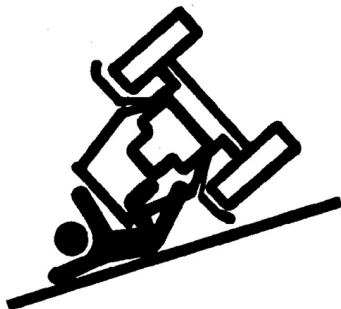

- Avoid holes, ditches, and obstructions which may cause machine roll-over, especially on hillsides. Avoid sharp turns on hills.
- Never drive near the edge of a gully or steep embankment.

- Stay off slopes that are too steep for operation.

Transport and Operate Safely

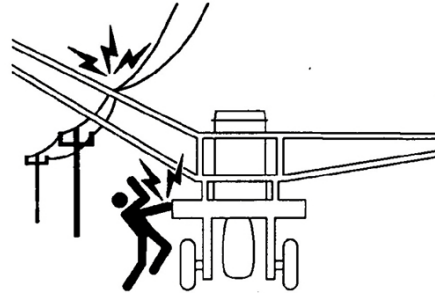

- Keep away from overhead power lines. Serious injury or death to you or others can result if machine contacts electrical wires. Know the transport and operating height of your machine.
- Perform a complete assessment of the field before performing any operations to determine the best working method.
- Stop slowly to avoid “nose diving”.
- Keep SMV emblem and reflectors clean and in place.
- Do not exceed maximum transport speed specified in the operator’s manual.
- Reduce speeds for icy, wet, graveled, or soft roadway surfaces.
- Check and follow local regulations for equipment size, lighting, and marking before driving on public roadways.

Prevent Machine Runaway



- Avoid possible injury or death from machinery runaway.

- Do not start engine by shorting across starter terminals. Machine will start in gear if normal circuitry is bypassed.
- NEVER start engine while standing on ground. Start engine only from operator's seat, with transmission in neutral or park.

Handle Fuel Safely - Avoid Fires



- Handle fuel with care - it is highly flammable. Do not refuel the machine while smoking or when near open flame or sparks.
- Always stop engine before refueling machine. Fill fuel tank outdoors.
- Prevent fires by keeping machine clean of accumulated trash, grease, and debris. Always clean up spilled fuel.
- Use only an approved fuel container for transporting flammable liquids.
- Never fill fuel container in pickup truck with plastic bed liner. Always place fuel container on ground before refueling. Touch fuel container with fuel dispenser nozzle before removing can lid. Keep fuel dispenser nozzle in contact with fuel container inlet when filling.
- Do not store fuel container where there is an open flame, spark, or pilot light, such as within a water heater or other appliance.

Handle Agricultural Chemicals Safely



Chemicals used in agricultural applications such as fungicides, herbicides, insecticides, pesticides, rodenticides, and fertilizers can be harmful to your health or the environment if not used carefully.

Always follow all label directions for effective, safe, and legal use of agricultural chemicals.

Reduce risk of exposure and injury:

- Wear appropriate personal protective equipment as recommended by the manufacturer. In the absence of manufacturer's instructions, follow these general guidelines:
 - Chemicals labeled **DANGER**: Most toxic. Generally require use of goggles, respirator, gloves, and skin protection.
 - Chemicals labeled **WARNING**: Less toxic. Generally require use of goggles, gloves, and skin protection.
 - Chemicals labeled **CAUTION**: Least toxic. Generally require use of gloves and skin protection.
- Avoid inhaling spray or dust.
- Always have soap, water, and towel available when working with chemicals. If chemical contacts skin, hands, or face,

wash immediately with soap and water. If chemical gets into eyes, flush immediately with water.

- Wash hands and face after using chemicals and before eating, drinking, smoking, or urination.
- Do not smoke or eat while applying chemicals.
- After handling chemicals, always bathe or shower and change clothes. Wash clothing before wearing again.
- Seek medical attention immediately if illness occurs during or shortly after use of chemicals.
- Keep chemicals in original containers. Do not transfer chemicals to unmarked containers or to containers used for food or drink.
- Store chemicals in a secure, locked area away from human or livestock food. Keep children away.
- Always dispose of containers properly. Triple rinse empty containers and puncture or crush containers and dispose of properly.

Avoid Exposure to Chemicals



⚠ CAUTION

Exposure to chemicals, including pesticides, can cause injury or death. **DO NOT RELY ON CAB, CAB PRESSURE INDICATOR, OR CAB AIR FILTERS TO PROTECT AGAINST CHEMICAL EXPOSURE.**

To reduce risk of chemical exposure:

- Wear **PERSONAL PROTECTIVE EQUIPMENT** in accordance with chemical manufacturer's label
- Allow only trained, certified applicators to apply chemicals
- Always close the windows and doors during application
- Verify that John Deere-activated carbon filters, or appropriate substitutes, are installed at all times (see "Check and Replace Cab Air Filters" in the Cab and Air Conditioning section of your machine operator's manual)
- Keep chemicals out of the cab
- Clean or remove contaminated shoes or clothing before entering the cab
- Keep cab interior clean

Read and follow all instructions in:

- Manufacturer's label for each chemical applied
- U.S. Environmental Protection Agency (EPA) Worker Protection Standard for Agricultural Pesticides
- State or regional guidelines for worker safety and health
- Operator's Manual for this machine
- Numerous requirements must be met, including but not limited to EPA regulations
- Even while inside cab, always wear long sleeves, long pants, shoes, and socks when applying chemicals, including pesticides

- If necessary to leave cab when chemicals, including pesticides are present, always use personal protective equipment recommended by the chemical manufacturer
- Before re-entering the cab, remove personal protective equipment used to handle chemicals, including pesticides, and store equipment in accordance with EPA guidelines to prevent contaminating cab

Clean Vehicle of Hazardous Chemicals, Including Pesticides

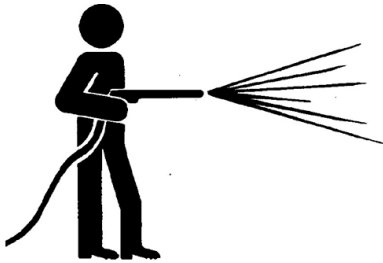

⚠ CAUTION

During application of hazardous chemicals, including pesticides, residue can build up on the inside and outside of the machine. Clean vehicle according to use instructions of hazardous chemical.

When exposed to hazardous chemicals, clean exterior and interior of machine daily to keep free of accumulation of visible dirt and contamination.

1. Sweep or vacuum the cab floor.
2. Clean headliners and inside cowlings of cab.

IMPORTANT: Directing pressurized water at electronic/electrical components or connectors, bearings and hydraulic seals, fuel injection pumps, or other sensitive parts

and components may cause product malfunctions. Reduce pressure and spray at a 45 to 90-degree angle.

3. Wash entire exterior of machine.
4. Dispose of any wash water with hazardous concentrations of active or non-active ingredients according to published regulations and directives.

Non-Permissible Use

Pay attention to the following applications for which the machine is NOT SUITABLE.

- Spreading of substances other than crop protection chemicals, dry fertilizers, and agriculture products.
- Use of the tank as a storage medium for substances not intended for crop protection or fertilization purposes.

⚠ CAUTION

Working on an unclean machine poses unnecessary danger and is therefore forbidden.

Emergency Exit

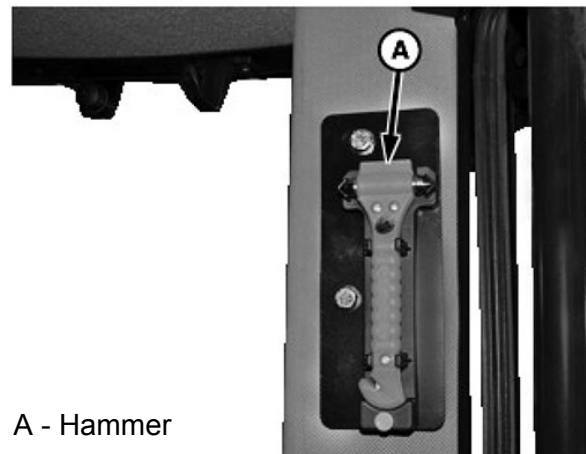

A - Hammer

⚠ CAUTION

Cover eyes, face, and uncovered skin from jagged or broken glass when using hammer to break the glass.

In an emergency, exit the cab through the entrance door when possible. In the event an exit cannot be achieved via the entrance door, a Hammer (A) is fitted in the cab that can be used to break a window to use as an exit.



SECTION 3 – SAFETY SIGNS

Replace Safety Signs



Replace missing or damaged safety signs. Use this operator's manual for correct safety sign placement.

There can be additional safety information contained on parts and components sourced from suppliers that is not reproduced in this manual.

Rinse Tank Decal

(650114 - Located near fill station)

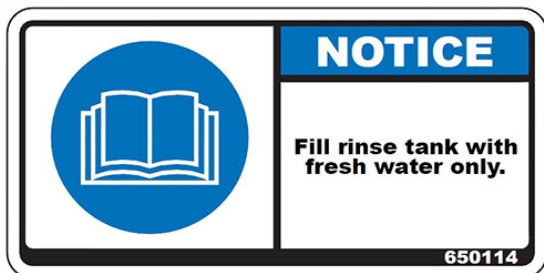

Hand Wash Tank Decal

(N408864 - Located near hand wash tank)



Chemical Exposure Decal

(N303688 - Located on rear right-hand cab post)



Charge Port Decal

(650516 - Located near eductor)

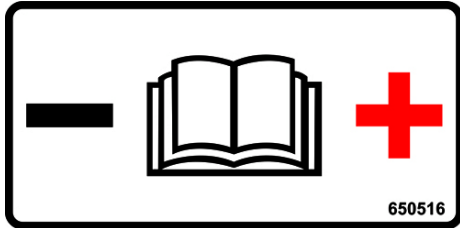

Negative Terminal Positive Terminal

Do Not Enter Solution Tank Decal

(N404968 - Located near solution tank lid)



Hydraulic Oil Under Pressure Decal

(HXE28534 - Located on left-hand side of transom)

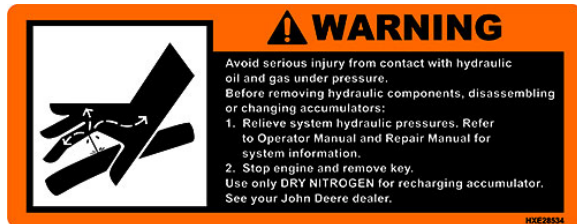

Chemical Hazard Decal

(N203265 - Located near solution tank lid)

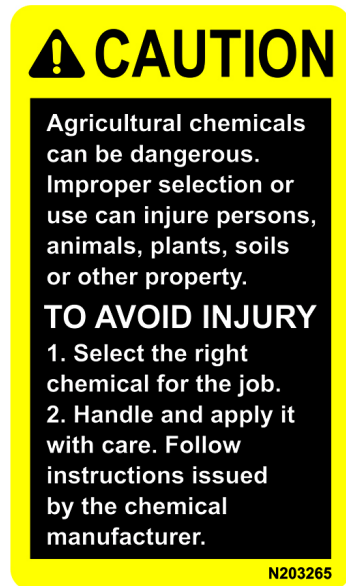

Electrical Power Lines Decal

(N204628 - Located on front left-hand cab post)



Do Not Pressure Wash Decal

(N408933 - Located near each boom
section valve)

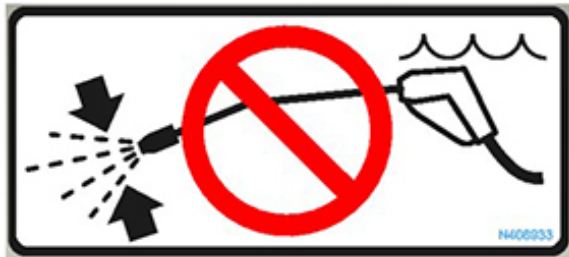

Transport Decal

(651031 - Located on Liquid System
transport cart)





SECTION 4 – SAFETY FEATURES

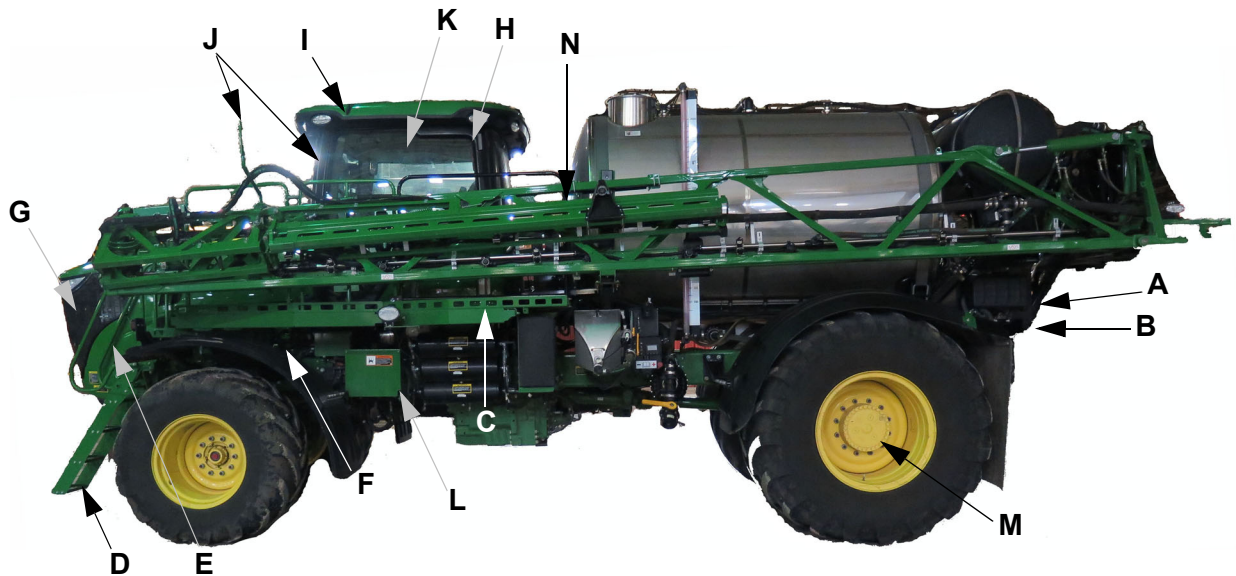

- **A - SMV EMBLEM** - Alerts following traffic of your presence on roads.
- **B - FRONT AND REAR HAZARD LIGHTS** - Alert oncoming and following traffic of your presence on roads.
- **C - SLIP RESISTANT SURFACES** - Help prevent slippage when walking on platform.
- **D - INDENTED STEPS AND PLATFORMS** - Help prevent slipping when on platform or ladders, also diminishes dirt and mud buildup.
- **E - HAND RAILS** - Give support when climbing onto machine or walking on platforms.
- **F - STARTER SOLENOID SHIELDING** - For bypass start prevention.
- **G - FAN GUARDING** - Provides protection from the engine fan.
- **H - EMERGENCY EXIT** - Allows exit from the right-hand side of cab, if necessary.
- **I - SPRAYER STYLE CAB WITH SEAT BELT** - For operator comfort and safety.
- **J - WINDSHIELD WIPERS AND LARGE REARVIEW MIRRORS** - For clear view of surroundings.
- **K - AUTOMATIC PARK BRAKE** - Prevents unintended machine movement. Automatically engages when machine stops and the speed control lever is moved to neutral.
- **L - BATTERY DISCONNECT** - Ability to shut off all electrical power to machine.
- **M - AIR BRAKES** - Engaged when power zero is maintained for five (5) seconds.
- **N - STEP** - Allows access to the top of the solution tank.

NOTE: Right-hand side emergency exit (H) is available using the glass hammer on the rear left-hand cab post.

In addition to the safety features described here, other components and systems, safety signs on the machine, safety messages in the operator's manual and elsewhere, as well as the care and concern of a capable operator, contribute to the safety of operators and others nearby.



SECTION 5 – BOOMS

Information in this manual pertains to the Hagie Liquid System installed on your machine. Refer to your machine operator's manual for complete information on CommandCenter™ display features and operating instructions.

Access Boom and Nozzles

Access Application Through Display

1. Press the Menu Button.



Menu Button

2. Press the Machine Settings Tab.



Machine Settings Tab

3. Press the Boom and Nozzles Button.



Boom and Nozzles Button

Access Application Through Navigation Bar

Press Boom and Nozzles Button on navigation bar below display.

Boom and Nozzles Main Page

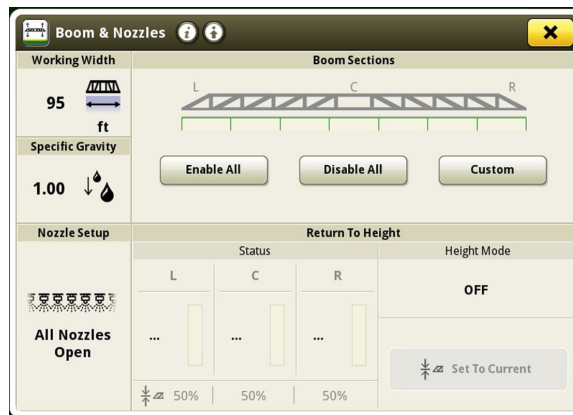

Boom and Nozzles Main Page

NOTE: Underscored text identifies that additional information is available within this section or another section of this publication.

NOTE: Main page shown is for example only. Your main page may differ, depending on options or connected equipment.

Boom and Nozzles application is used to configure boom sections, nozzles, and boom height control mode. Adjust to maintain proper boom height above the crop or ground and to obtain the desired application rate. Adjust when the crop or terrain conditions change and when the number of nozzles or sections spraying have been altered from previous setting.

Items Accessible on the Boom and Nozzles Main Page:

Section Status - Indicates the status of each boom section.

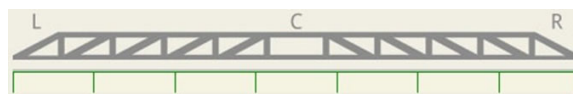

Boom Sections

SECTION 5 – BOOMS



Enable All - Enable all boom section control valves. Sections are controlled by the Spray System Master Switch.



Enable All

Disable All - Disable all boom section control valves. Sections are not controlled by the Spray System Master Switch.



Disable All

Custom - Enable or disable desired sections. Only enabled sections are controlled by the Spray System Master Switch.



Custom

Working Width - Displays the actual width the sprayer will apply product.

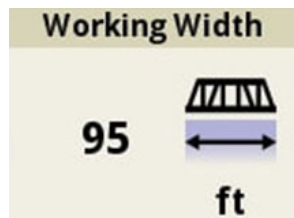

Working Width

Specific Gravity - Ensures that the pressure-based tank level sensor accurately reports current solution tank volume.



Specific Gravity

Nozzle Setup - View and change nozzle configuration.

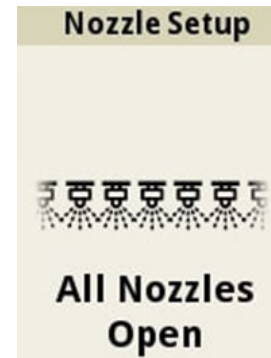

Nozzle Setup

Advanced Settings - Access further adjustments and less common settings.



Advanced Settings

Run Page Modules

Modules for this application can be added to run pages using Layout Manager. (See “Layout Manager” in the display operator’s manual for further information).

NOTE: Different modules are available for your application.

Shortcut Keys

Sections - Quickly opens Boom Sections | Custom page for adjustments.



Sections

Shortcut Keys for this application can be added to the shortcut bar using Layout Manager. (See “Layout Manager” in the display operator’s manual for further information).

NOTE: Different shortcut keys can be available for your application.

Boom Sections | Custom

Boom Sections | Custom allows you to enable or disable all boom sections. Boom sections can also be individually turned on/off.

Modify When:

- Spraying at a reduced width is required.
- Sections must be turned on one at a time.

Items Accessible on Boom Sections | Custom Page:

Enable All - Enable all boom section control valves. Sections are controlled by the Spray System Master Switch.



Enable All

Disable All - Disable all boom section control valves. Sections are not controlled by the Spray System Master Switch.



Disable All

Section Status Preview - Indicates the status of each boom section.



Section Status Preview

Section Enable/Disable - Enable/Disable an individual section.



Section Enable/Disable

Customize Sections - Change the number of nozzles in each section or the number of sections on the boom.



Customize Sections

Procedure to Modify:

1. Select sections to modify.



Section Status Preview

NOTE: Up to five (5) sections can be modified at one time; those sections are outlined on the screen. Sections are also selectable using the dial on the navigation bar.

2. Enable/disable the desired sections in the current selection by selecting the check box for that section.



Section Enable/Disable

3. Repeat for the remaining sections.
4. Select Close Button to return to previous page.



Close

Working Width

Working Width is automatically calculated by the spray rate control unit based on the number of sections, section configuration, and number of outer nozzles turned off.

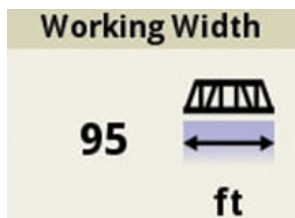

Working Width

Adjustments to Working Width (1) may require changes in Track Spacing (2) as a result.

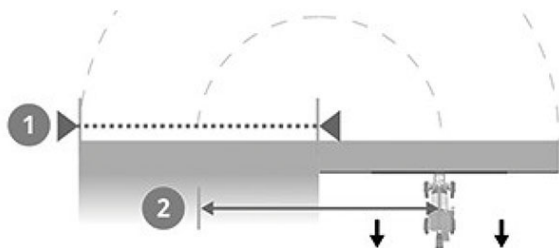

Working Width

If Working Width displayed is not equal to expected width, verify the following:

- Nozzle Setup is correct.
- Proper number of Boom Sections are enabled.
- Total number of boom sections entered in Advanced Settings is correct.
- Section Setup information is entered correctly in Advanced Settings.

Specific Gravity

Specific Gravity - Ensures that the pressure-based tank level sensor accurately reports current solution tank volume.

NOTE: Rate Control may use it to modify prediction for pressure or pump speed to expect for more or less dense fluid.

Modify When:

- Filling the solution tank with a chemical of different density (especially when using on-board filling pump and level sensing to shut off the fill).

Procedure to Modify:

1. Select Specific Gravity.



Specific Gravity

2. Enter desired value on keypad (ranging from 0.85 to 2.5).
3. Select OK to confirm.



OK

Nozzle Setup

Nozzle Setup allows you to view and change nozzle configurations. Nozzles must be properly configured for the spray rate control unit to apply the desired rate of solution.

Modify When:

- Performing broadcast application.
- Spraying at a reduced width that cannot be achieved with section shut-offs.
- Performing band spraying application.

Active Nozzle Configurations:

All Nozzles Open - All nozzles on the boom are open and spray when activated.



All Nozzles Open

Number of Outer Nozzles Closed - Number of outer nozzle bodies turned off by manually turning the nozzle body.

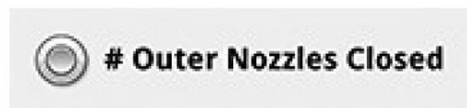

Outer Nozzles Closed

Procedure to Modify All Nozzles Open:

1. Select the Nozzle Setup area on the Boom and Nozzles Main Page.



Nozzle Setup

2. Select All Nozzles Open.



All Nozzles Open

3. Select Close Button to return to previous page.



Close

Procedure to Modify Number of Outer Nozzles Closed:

1. Select the Nozzle Setup area on the Boom and Nozzles Main Page.

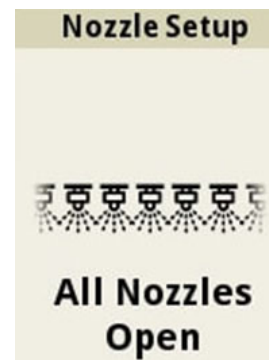

Nozzle Setup

2. Select Number of Outer Nozzles Closed.



Outer Nozzles Closed

3. Select input box.



Input

SECTION 5 – BOOMS



4. Enter the number of outer nozzles closed using the keypad.
5. Select OK to confirm.



OK

6. Select Close Button to return to previous page.



Close

NORAC®

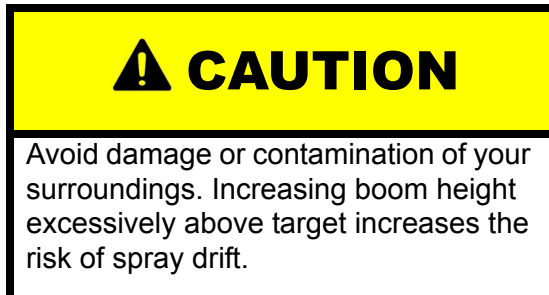

The NORAC system automatically controls boom height functions relative to contours of the ground and crop canopy.

Modify When:

- Crop height changes
- Terrain contour changes
- Spraying in dusty or muddy conditions

Getting Started

1. On the Gen 4 display, press the Isobus VT (Virtual Terminal) Button on either the Main Run Page (A) or the Applications Menu (B).

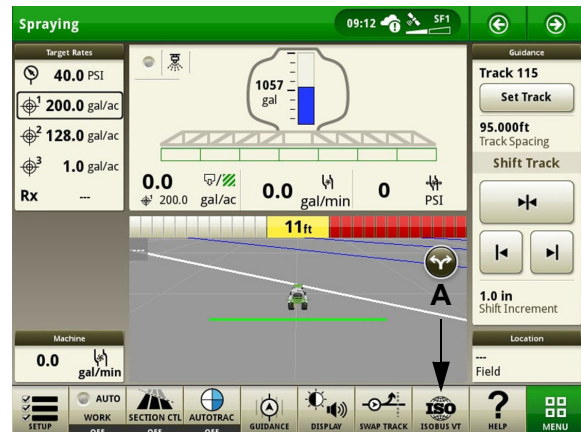

A - Isobus Button (Main Run Page)

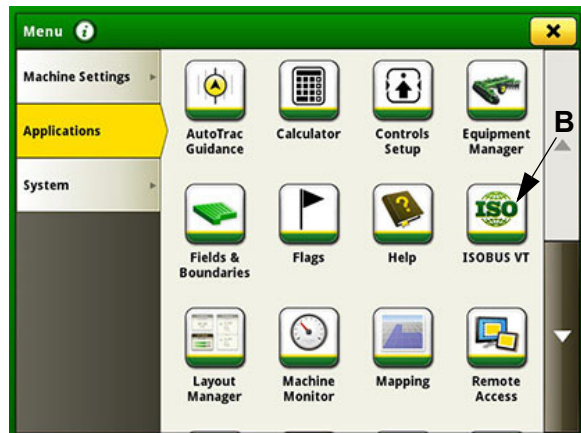

B - Isobus Button (Applications Menu)

2. On the Isobus VT Page, press the Menu Button (A) (to allow you to select controller on the Isobus connection).

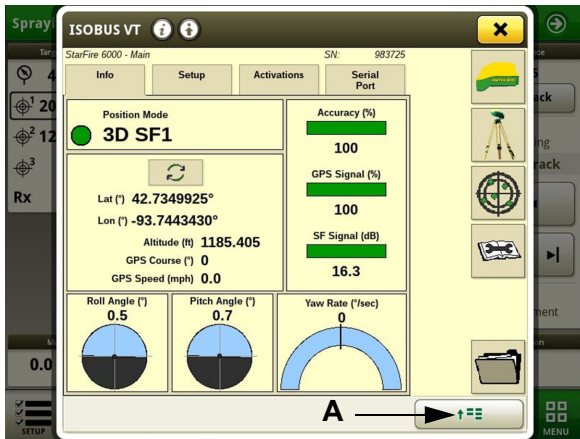

A - Menu Button

3. On the Connected Isobus Implements Page, select NORAC controller (A).

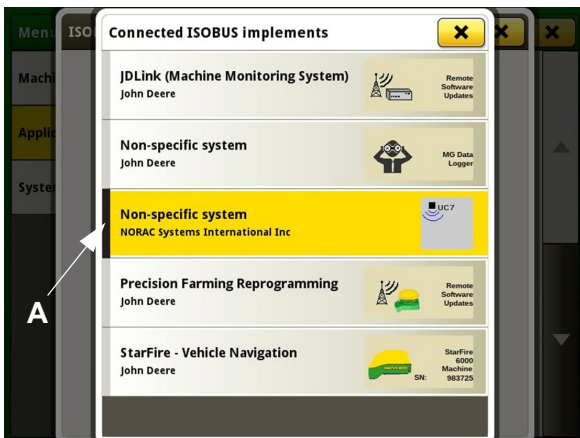

A - NORAC Controller Selection

4. Acknowledge the NORAC liability warning (A).

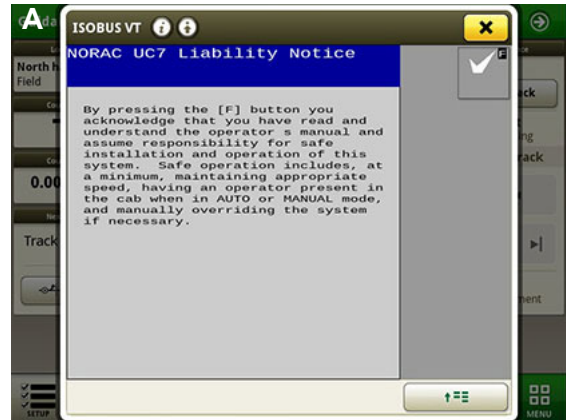

A - NORAC Liability Warning

NOTE: If the liability warning does not appear, navigate to the “UC7” screen. Press the checkmark to confirm, then acknowledge liability warning.

5. To Enable NORAC, press the desired Auto Button (A) or Manual Button (B) on the NORAC Home Page to the ON (illuminated) position.

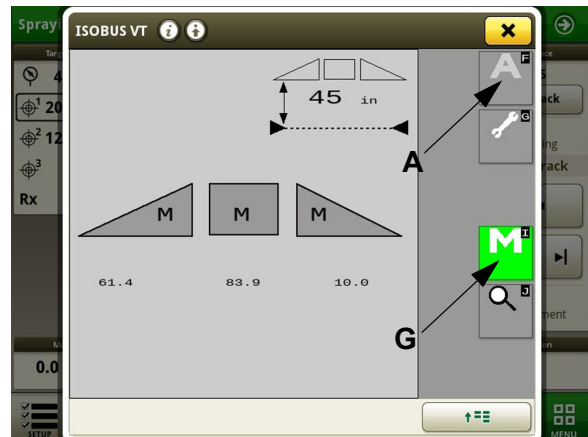

A - Auto Button
B - Manual Button

6. To Disable NORAC, press the corresponding Auto or Manual Button on the NORAC Home Page to the OFF (non-illuminated) position.

Further Information

Refer to the manufacturer’s operation manual for complete operating/calibrating instructions, troubleshooting information, and safety precautions.

NORAC System Settings

(Sensitivity, Soil/Crop Mode, and Target Height)

Sensitivity

Sensitivity is how responsive the system is. The lower the number, the lower the sensitivity. The higher the number, the higher the response time and hydraulic demand.

NOTE: Default sensitivity setting is 5.

On the Gen 4 Display:

- Press Settings Button (A) to navigate to the Settings Page.

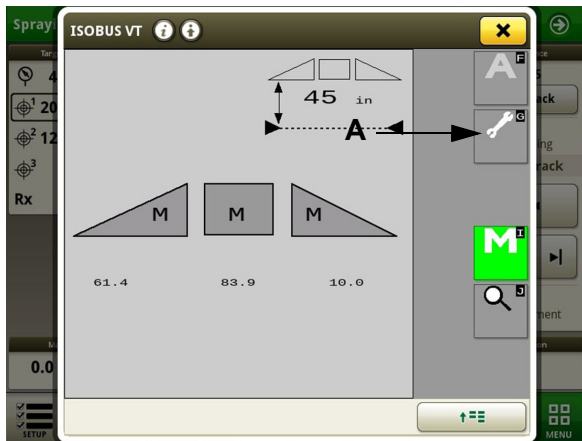

A - Settings Button

- Press Sensitivity cell (A) and increase or decrease system sensitivity value from 1-10.

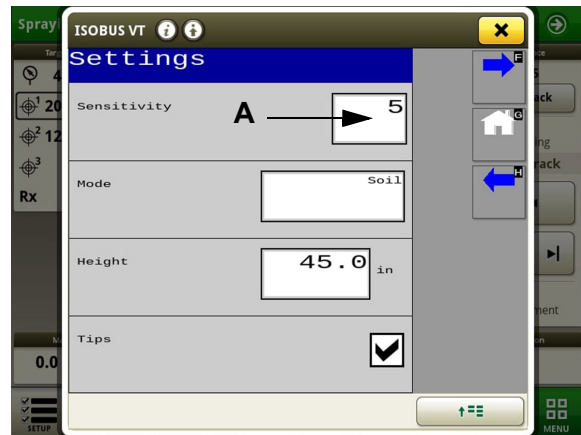

A - Sensitivity

Soil/Crop Mode

Soil Mode allows the sensors to read the height from the spray nozzles to the ground. Crop Mode allows the sensors to read the height from the spray nozzles to the top of the crop canopy.

On the Gen 4 Display:

- Press the Settings Button (wrench icon) on the NORAC Home Page to navigate to the Settings Page.
- Press the cell (next to “Mode”) and select Soil, Crop, or Hybrid.

NOTE: Hybrid Mode is an improved Crop Mode, which uses a combination of the crop and soil readings to improve control. This setting is recommended in place of Crop Mode.

Target Height

Target Height is the height you desire the boom to be set at when spraying.

NOTE: When operating in Soil Mode, the Target Height is measured from the spray nozzles to the soil. In Crop Mode, the target height is measured from the crop canopy to the spray nozzles.

On the Gen 4 Display:

- Press the Settings Button (wrench icon) on the NORAC Home Page to navigate to the Settings Page.
- Press the cell (next to “Height”) and increase or decrease value to desired boom height.

Tips

The Tips selection box allows the operator to disable the outer boom sensors. When this box is unchecked (tips off), the operator may fold in the outer fold sections and spray with the main fold sections.

NOTE: The Tips selection box is defaulted to be checked (tips on).

Further Information

Refer to the manufacturer’s operation manual for complete operating/calibration instructions, troubleshooting information, and safety precautions.

**Re-Engage NORAC®
Through Multi-Function
Lever**

Re-Engaging Auto Mode after manually moving the boom may be achieved by adjusting NORAC setup options for Double Tap Wings, or Headland Mode and/or Terrain Assist.

Double Tap Wings

1. Press Settings Button (A).

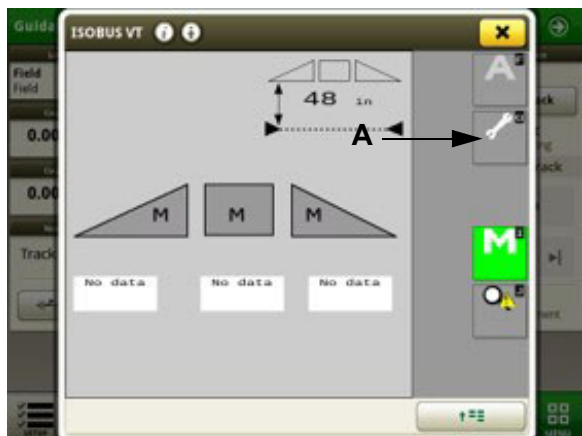

A - Settings Button

2. Press Advance Button (A) twice.

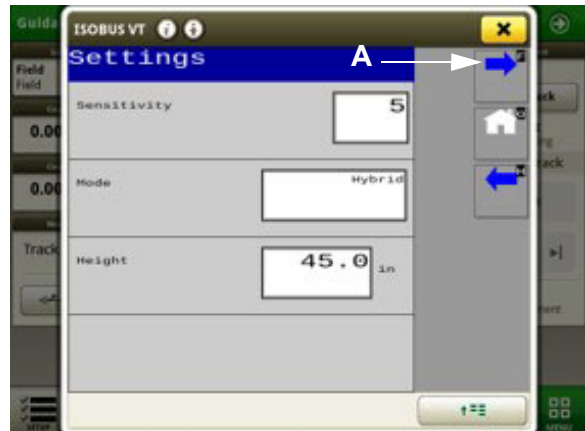

A - Advance Button

3. Press Check Page Button (A).

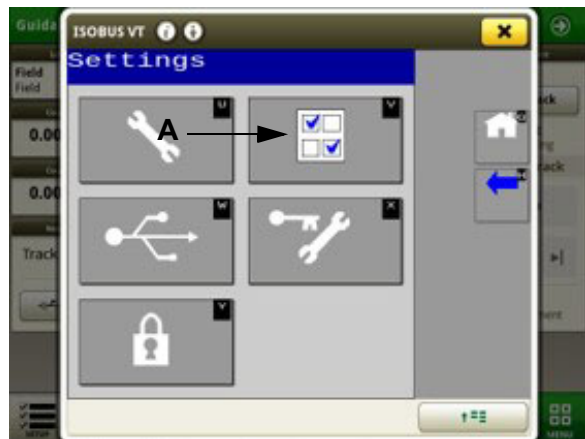

A - Check Page Button

4. Select Remote Switches (A).
5. Press Advance Button (B) twice.

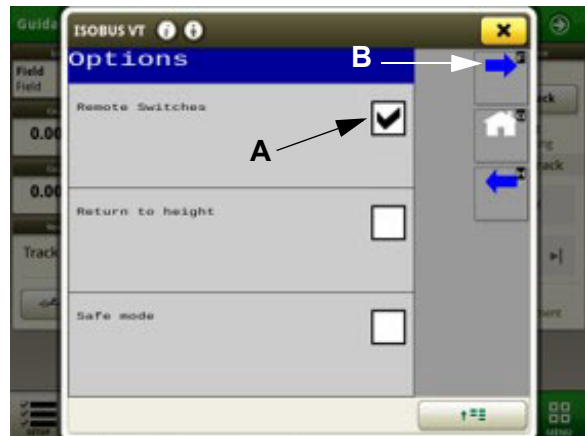

A - Remote Switches
B - Advance Button

6. Select Double Tap Wings (A).

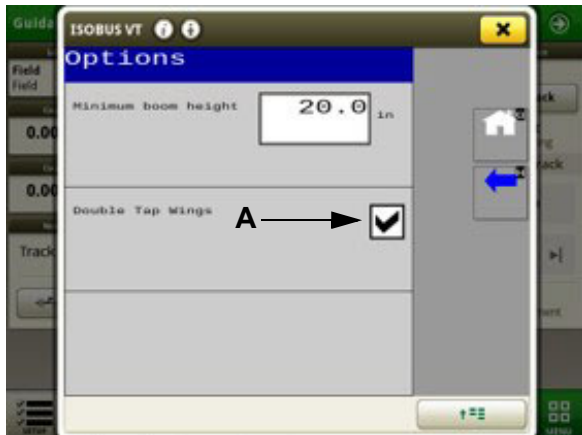

A - Double Tap Wings

7. On the Home Page, press Auto Mode Button (A) to enable NORAC automatic mode.

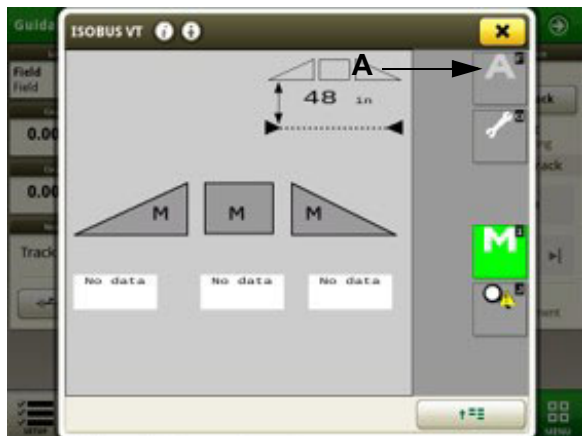

A - Auto Mode Button

8. With one wing raised (to avoid any obstacle), wing can return to auto mode by “double tapping” desired Left Boom Lower Switch (A) or Right Boom Lower Switch (B) on the Multi-Function Lever.



A - Left Boom Lower Switch
B - Right Boom Lower Switch

Headland Assist™/Terrain Assist™

When Main Lift Trigger is enabled, the feature selected (Headland Mode – Main, Headland Mode – Wings, or Terrain Assist) will be engaged when the Main Up Switch on the Multi-Function Lever is pressed, and disengaged when the Main Lower Switch on the Multi-Function Lever is pressed (when in auto mode).

1. Press Settings Button (A).

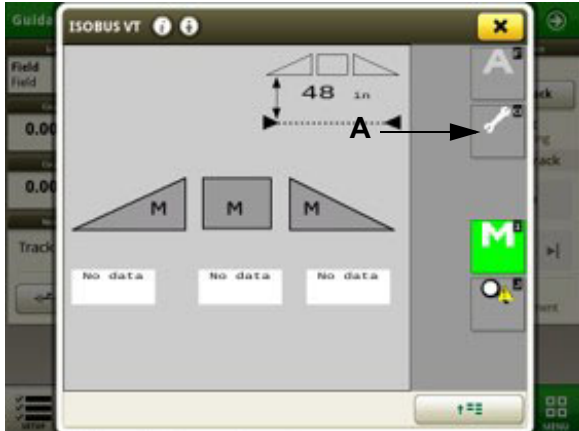

A - Settings Button

4. Press Advance Button (A) twice.

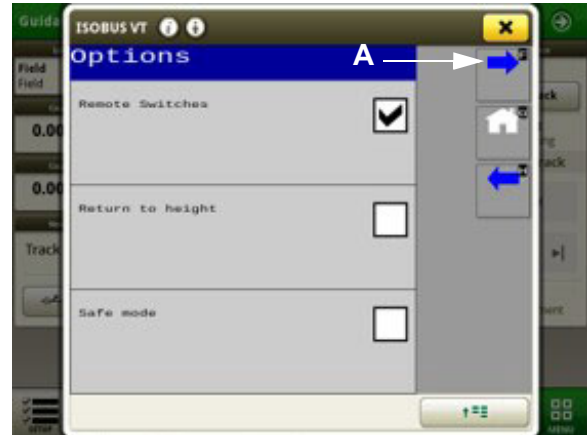

A - Advance Button

2. Press Advance Button (A) twice.

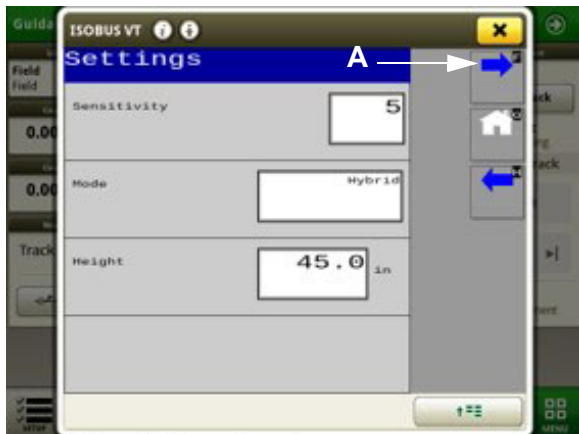

A - Advance Button

5. Press Main Lift Trigger cell (A) and select desired option (Headland Mode – Main, Headland Mode – Wings, or Terrain Assist).

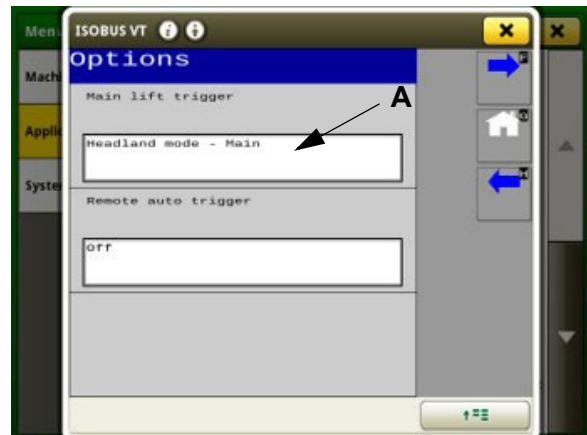

A - Main Lift Trigger

3. Press Check Page Button (A).

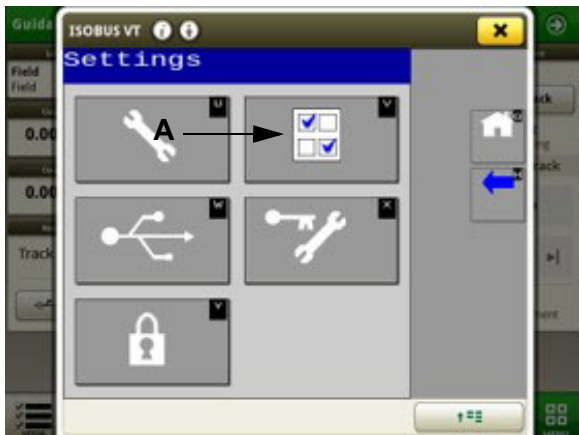

A - Check Page Button

NOTE: Headland Assist and Terrain Assist cannot both be set to Main Lift Trigger at the same time.

NOTE: Remote Auto Trigger is not available on the LS475. Leave set to Off.

SECTION 5 – BOOMS



6. On the Home Page, press Auto Mode Button (A) to enable NORAC automatic mode.

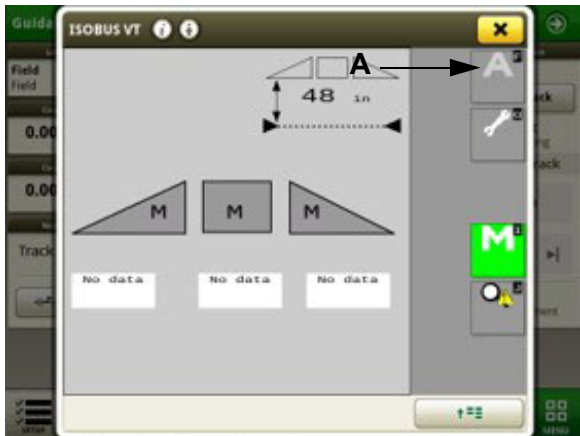

A - Auto Mode Button

7. When Main Lift Trigger is set to “Headland Mode – Main” and when coming up to a headland, press Main Up Switch (A) on the Multi-Function Lever once to raise entire main lift to set headland height. To revert back to normal operating height, press Main Down Switch (B) on the Multi-Function Lever.

NOTE: When Main Lift Trigger is set to “Headland Mode – Wings”, only the wing sections will raise to set headland height.

NOTE: When Main Lift Trigger is set to “Terrain Assist”, the boom will function similarly to Headland Mode – Main, but will have a longer delay for re-engaging.



A - Main Up Switch
B - Main Down Switch

Further Information

Refer to the NORAC manufacturer’s operation manual for further information on Headland Assist and Terrain Assist.

Section Setup

Section Setup allows you to enter the number of nozzles and nozzle spacing for each section. Sections must be properly configured to obtain the desired application rate.

Your boom is equipped with two (2) sets of nozzles on the same pipe. Depending on which set of nozzles is being used, the values set up in the Gen 4 display must match. Refer to the Nozzle Spacing Layout illustration at the end of this section for further information.

NOTE: Cam-lock flood tips are set up for 60" spacing on-center. Factory default can be set up for 36 high-flow turrets that are off-center.

Modify When:

- Switching between the two nozzle types.
- The number of sections has changed.
- Band spraying.
- Custom plumbing configurations are installed.

Section Setup Procedure:

1. Select the Section Setup Button.



Section Setup Button

2. Select section to change.

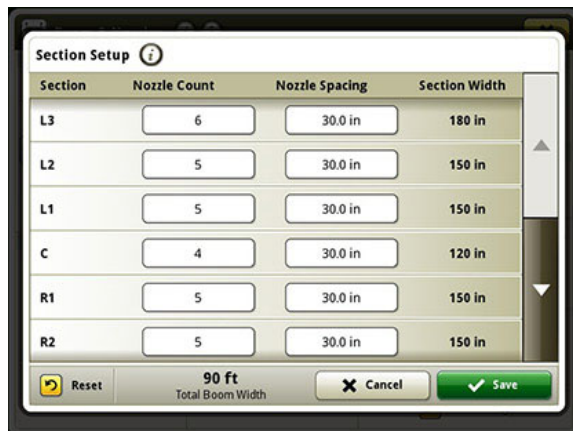

Section Setup

3. Change nozzle count (nozzles spraying on each section) and/or nozzle spacing (distance between nozzle bodies), as required.

NOTE: Section Width is automatically calculated based on the input number of nozzles and nozzle spacing.

4. Select the Save Button to complete section setup.



Save

Select the Cancel Button to revert to the previous screen without making changes to configuration.



Cancel

Select the Reset Button to return the machine to factory configurations. Any previous changes are lost.



Reset

Nozzle Spacing Layout - 60”(152.4 cm) / 30”(76.2 cm)

Total Application Width

Turret = 90'

Cam-Lock = 95'

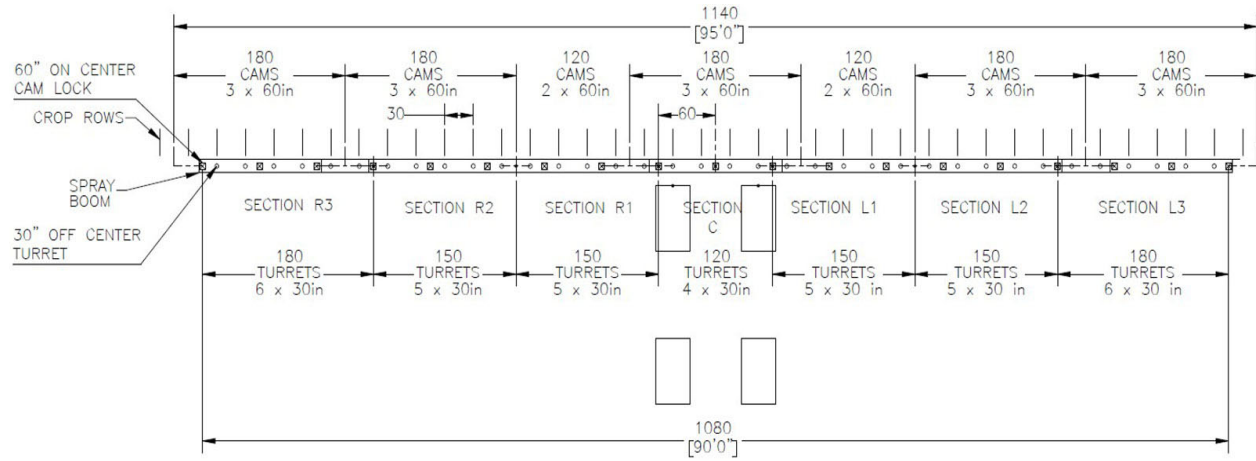



SECTION 6 – CALIBRATIONS

Information in this manual pertains to the Hagie Liquid System installed on your machine. Refer to your machine operator's manual for complete information on CommandCenter™ display features and operating instructions.

Access Calibrations and Procedures

Access Application Through Display

1. Press the Menu Button.



Menu Button

2. Press the Machine Settings Tab.



Machine Settings Tab

3. Press the Calibrations Button.



Calibrations Button

Calibrations and Procedures Overview

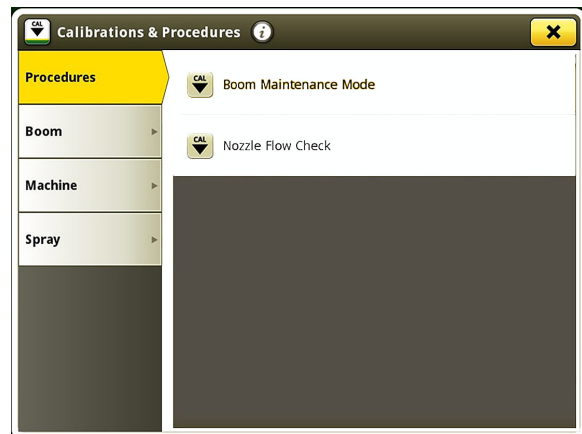

Calibrations and Procedures Page

NOTE: Underscored text identifies that additional information is available within this section or another section of this publication.

NOTE: Main page shown is for example only. Your main page may differ, depending on options or connected equipment.

Calibration application provides centralized access to maintenance calibrations for the machine.

Procedures Tab

Boom Maintenance Mode

Nozzle Flow Check



Procedures Tab

SECTION 6 – CALIBRATIONS



Boom Calibration Tab

Auto Boom Fold/Unfold

Center Frame Position

Level Position

Tilt Sensors

Tilt Valves

Reset Calibrations



Boom Calibration Tab

Spray Calibration Tab

Flow Meters

Pressure Sensors

Solution Pumps

Pressure Valves

Reset Calibrations



Spray Calibration Tab

Boom Maintenance Mode

This procedure can be used to manually control the individual movement of boom sections and the center frame. Operating in boom maintenance mode moves the boom at a slower speed than normal folding operation.

Use When:

- Repair or service is necessary.

- Unfolding or folding boom outside of the normal sequence.
- Unfolding or folding boom in tight areas.
- Diagnosing boom folding problems.

Boom Maintenance Mode Procedure

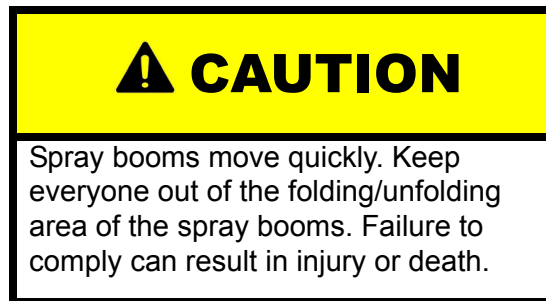

IMPORTANT: Booms can contact and may damage the exhaust stack and/or walkway handrail when using maintenance mode to fold and unfold booms. Do not allow booms to go higher than the top of the cradle support when operating boom in maintenance mode.

NOTE: This procedure enables fully folding/unfolding the boom and raising tilts to highest positions. Ensure that adequate space is available.

1. Select Boom Maintenance Mode.
2. Select Begin Procedure to operate boom in maintenance mode.

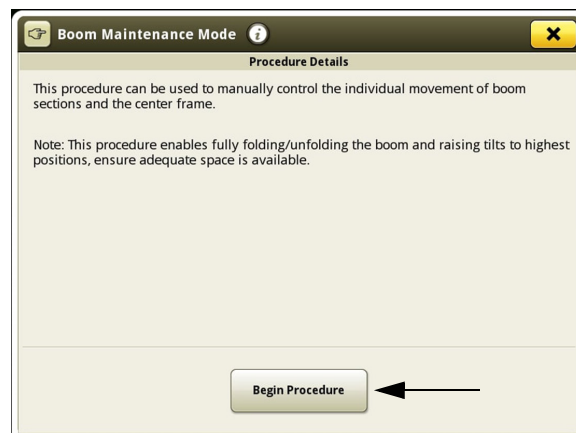

Begin Procedure

3. Press the list box.

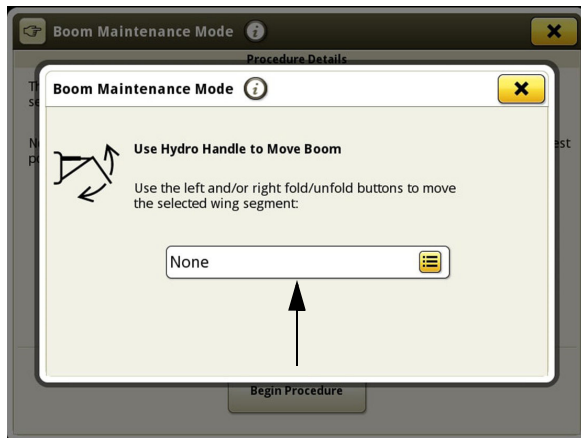

List Box

6. Unfold or fold the selected boom segment using the corresponding Boom Fold Switch on the multi-function lever.

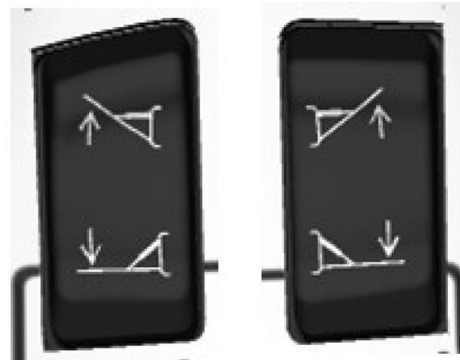

Boom Fold Switches

4. Select desired boom segment (inner boom or outer boom).

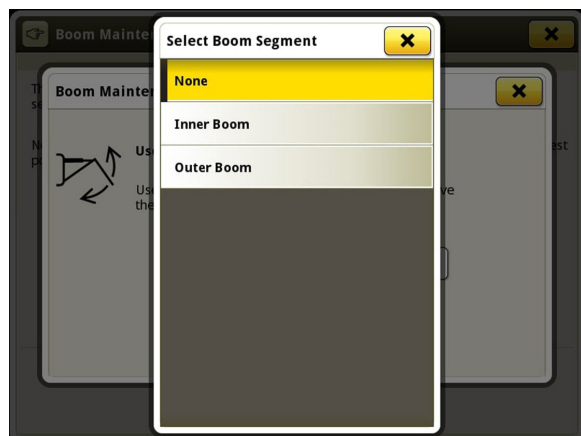

Select Boom Segment

7. Select Close Button to exit.



Close

5. Press and hold Boom Fold Mode Lever on cab floor.

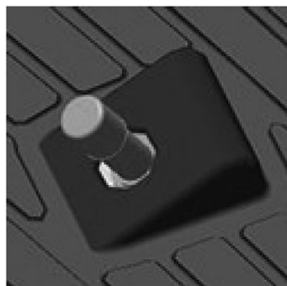

Boom Fold Mode Lever

Nozzle Flow Check

This procedure allows you to quickly determine if the current spray tips installed are worn, damaged, or partially plugged or if they can apply the target rate. Spray type must function properly to achieve the correct application rate and coverage.

Perform When:

- Beginning the season.
- Spray tips, solution pump, or pressure transducers are replaced.
- Actual rate and target rate are not equal.

How to Interpret Test Results:

If detected nozzle size is smaller than the installed spray tips, then tips may be partially plugged or the tips are not capable of applying the selected target rate.

If detected nozzle size is larger than the installed tip size, then the tips may be worn, damaged, or too large for the selected target rate.

SECTION 6 – CALIBRATIONS



Nozzle Flow Check Procedure Requirements:

Machine State:	Parked
Solution Tank State:	Filled with Clean Water
Engine State:	Running at High Idle
Solution Pump	On

Items Accessible on Procedure | Nozzle Flow Check Page:

Test Speed - desired application speed.



Test Speed

Active Target Rate - desired application rate.

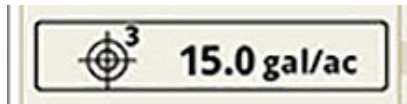

Active Target Rate

Status Indicator - displays status of the test.



Status Indicator

Tank Volume - displays the calculated or entered tank volume.



Tank Volume

Boom Section Status - displays the status of each boom section.

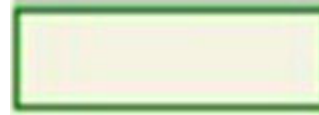

Boom Section Status

Actual Application Rate - rate applied during test.



Actual Application Rate

Solution Flow - current solution flow rate.



Solution Flow

Solution Pump Pressure - pressure measured at pump, displayed when spray system master switch is OFF.



Solution Pump Pressure

Boom Pressure - pressure measured at boom, displayed when spray system master switch is ON.

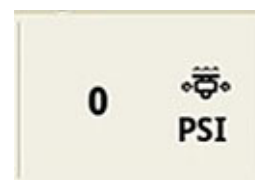

Boom Pressure

Detected Nozzle Size Performance - calculated size of nozzles installed on the machine.

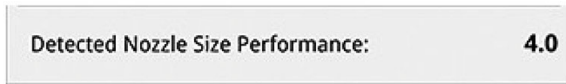

Detected Nozzle Size Performance

Nozzle Flow Check Procedure

IMPORTANT: Do not perform nozzle flow check with chemicals in tank. Incorrect application may result in crop damage or environmental contamination.

NOTE: The nozzle flow check procedure will use whatever the current pump operating mode is.

1. Select Nozzle Flow Check.
2. Select Begin Procedure.



Begin Procedure

3. Adjust test speed to desired level. Select plus (+) to increase or minus (-) to decrease desired level.



Test Speed

NOTE: Test Speed can also be adjusted using the navigation bar adjustment dial.

4. Select desired active target rate using the Rate Select Switches on the CommandARM™.

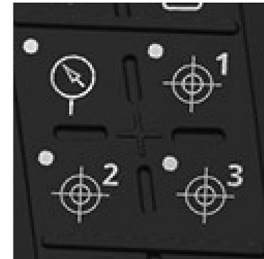

Rate Select

NOTE: If necessary, select Active Target Rate to edit Target Rate Presets.

5. Verify the number of desired sections. See Boom Sections | Custom.

NOTE: Nozzle Flow Check only activates enabled sections.

6. Press the Spray System Master Switch to begin test.



Spray System Master Switch

NOTE: Status Indicator displays the current status of the Nozzle Flow Check. A message is displayed about the status.

NOTE: Detected nozzle size is displayed on-screen.

7. Press Spray System Master Switch to stop test.
8. Select Close Button to return to previous page and end procedure.



Close

SECTION 6 – CALIBRATIONS



Indicator Status

The Status Indicator displays the current status of the Nozzle Flow Check. A message is displayed about the status.



Status Indicator - Gray
(Testing Stopped)

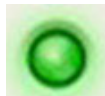

Status Indicator - Green
(Testing in Progress)

Boom Section Status

Boom Section Status is shown for each section on the spray boom.

Section Ready - spray section is enabled and will begin spraying when spray system master switch is depressed.



Section Ready - Green Outline

Section Applying - spray section is currently applying product.



Section Applying - Green

Section Applying Fault - spray section fault detected.



Section Applying Fault - Red Underline

Section Control Auto OFF - spray section is commanded off by section control system and is not applying product.



Section Control Auto OFF

Section Indexed OFF - spray section is commanded off by indexed boom section (IBS) switches on the multi-function lever and is not applying product.



Section Indexed OFF - Black

Section Disabled - spray section is disabled using the boom and nozzles application. Spray section will not apply product when spray system master switch is depressed.

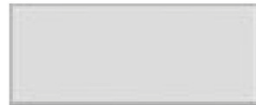

Section Disabled - Gray

Boom Calibration | Auto Boom Fold/Unfold

This procedure calibrates the sensors on the boom that allow for automatic boom folding/unfolding. Sensors must be calibrated for the boom to fold and unfold properly when in automatic mode.

Perform Calibrations When:

- The boom is not folding or unfolding properly.
- Any boom sensor or linkage has been replaced.
- The fold/unfold cylinder that adjusts the boom sensor linkage has been replaced.
- The control unit has been replaced.

Details Displayed on Page:

Last Calibration:	Date and Time
Recommended Interval:	As Needed
Estimated Time Required:	Approx. 5 Minutes

Auto Boom Fold/Unfold Calibration Procedure

For best results, perform the following calibrations before Auto Boom Fold/Unfold calibration:

- Tilt Sensors Calibration - perform when sensors or linkage is replaced.

Procedure Requirements:

Engine State:	Running
Wheel Speed:	0 km/h (0 mph)
Operating State:	Parked, Not Applying Product
Boom State:	Folded

⚠ CAUTION

Spray booms move quickly. Keep all bystanders out of the folding and unfolding area of the spray booms. Failure to comply can result in injury or death.

IMPORTANT: Booms can contact and may damage the exhaust stack and/or walkway handrail when using manual mode to fold and unfold booms. Do not allow booms to go higher than the top of the cradle support when operating boom in manual mode.

IMPORTANT: This procedure requires fully unfolding the boom. Ensure that adequate space is available.

1. Press the Calibrate Button to begin procedure.

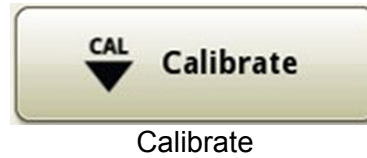

2. Follow message on-screen to complete procedure.
3. Press the Save Button to confirm calibration.



If Calibration Fails:

1. Press the Retry Button.



2. Verify all requirements listed on-screen have been met.
3. If calibration fails twice, see your John Deere dealer or qualified service provider for assistance.

Auto Boom Fold/Unfold | Boom Sensor Voltages

Sensor Voltages - displays voltage readings for boom sensors.

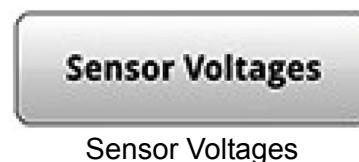

SECTION 6 – CALIBRATIONS



There is an indicator for each sensor, which displays the current voltage reading and the previously calibrated voltage range of the sensor.

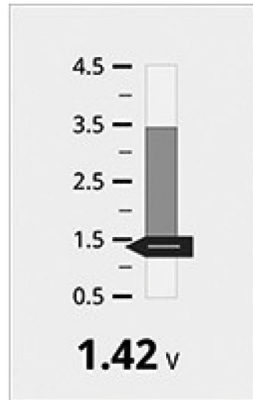

Voltage Indicator

Current Voltage Indicator - voltage reading from each sensor.



Black Marker

Voltage Range - the shaded area displays the range of previously calibrated voltages by each sensor.

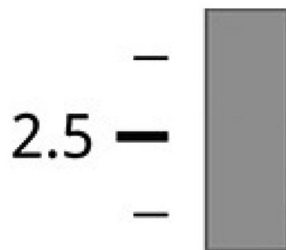

Voltage Range

Current Voltage Value - voltage is also displayed numerically at the bottom of the indicator.



Current Voltage Value

NOTE: If the current voltage value is red, then current reading is outside the calibrated range.

Auto Boom Fold/Unfold | Cradle Positions

Cradle Positions - displays reading of the tilt sensors.



Cradle Positions

There are indicators for right and left-hand tilt, which display the current amount of boom tilt as a percentage.

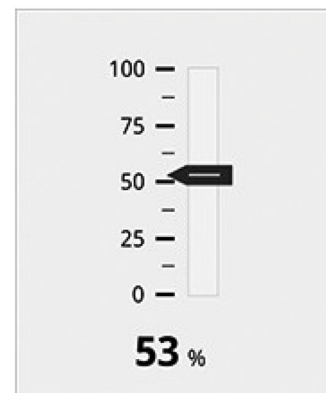

Left Tilt

Current Position Indicator - position reading from each boom tilt sensor.



Black Marker

Current Position Value - position is also displayed numerically at the bottom of the indicator.



Current Position Value

- **Minimum** - 0 percent, boom wing tilted fully down.
- **Maximum** - 100 percent, boom wing tilted fully up.

Boom Calibration | Center Frame Position

This procedure calibrates the center frame position sensor. Sensor must be calibrated for Return to Height and automatic boom fold/unfold to function properly.

Perform Boom Calibration When:

- Automatic boom fold or unfold not working properly.
- Return to Height not working properly.
- Center frame position sensor has been replaced.

Details Displayed on Page:

Last Calibration:	Date and Time
Recommended Interval:	As Needed
Estimated Time Required:	Approx. 1 Minute

Readings Displayed on Page:

Sensor Voltage - current voltage readings and voltage range for the center frame position sensor.

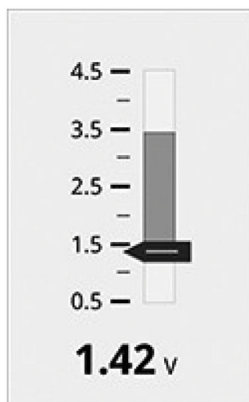

Sensor Voltage

Center Frame Position Calibration Procedure

Procedure Requirements:

Engine State:	Running
Operating State:	Parked on level surface, not applying product

CAUTION

Spray booms move quickly. Keep all bystanders out of the folding and unfolding area of the spray booms. Failure to comply can result in injury or death.

IMPORTANT: Booms can contact and may damage the exhaust stack and/or walkway handrail when using manual mode to fold and unfold booms. Do not allow booms to go higher than the top of the cradle support when operating boom in manual mode.

IMPORTANT: This procedure requires fully unfolding the boom. Ensure that adequate space is available.

1. Press the Calibrate Button to begin procedure.

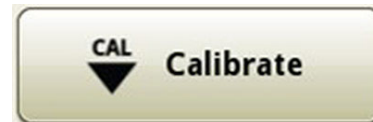

Calibrate

2. Follow messages on-screen to complete procedure.

3. Press the Save Button to confirm calibration.



Save

If Calibration Fails:

1. Press the Retry Button.



Retry

2. Verify all requirements listed on-screen have been met.
3. If calibration fails twice, see your John Deere dealer or qualified service provider.

NOTE: If readings are displayed in red, then that reading is outside the allowable range.

Boom Calibration | Level Position

This procedure calibrates the roll angle in the boom sensor. Roll angle must be calibrated so that NORAC® operates correctly.

Perform Calibration When:

- NORAC® is not working properly.
- Roll angle sensor replaced.

Details Displayed on Page:

Last Calibration:	Date and Time
Recommended Interval:	As Needed
Estimated Time Required:	< 1 Minute

Readings Displayed on Page:

Sensor Voltage - displays the current voltage reading for the roll angle sensor.

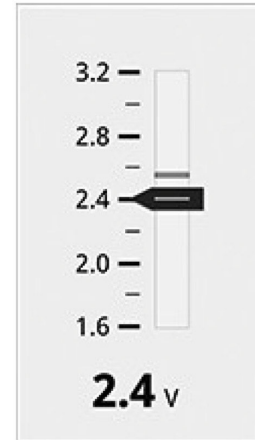

Sensor Voltage

Level Position Calibration Procedure

Procedure Requirements:

Engine State:	Running
Wheel Speed:	0 km/h (0 mph)
Operating State:	Not Applying Product
Ground Conditions:	Firm, Dry, and Level

⚠ CAUTION

Spray booms move quickly. Keep all bystanders out of the folding and unfolding area of the spray booms. Failure to comply can result in injury or death.

IMPORTANT: Booms can contact and may damage the exhaust stack and/or walkway handrail when using manual mode to fold and unfold booms. Do not allow booms to go higher than the top of the cradle support when operating boom in manual mode.

IMPORTANT: This procedure requires fully unfolding the boom. Ensure that adequate space is available.

1. Press the Calibrate Button to begin procedure.



Calibrate

2. Follow messages on-screen to complete procedure.
3. Press the Save Button to confirm calibration.



Save

If Calibration Fails:

1. Press the Retry Button.



Retry

2. Verify all requirements listed on-screen have been met.
3. If calibration fails twice, see your John Deere dealer or qualified service provider.

NOTE: If readings are displayed in red, then that reading is outside the allowable range.

Level Position | Sensor Voltage Indicator

There is a voltage indicator for the roll angle sensor, which displays the current voltage reading.

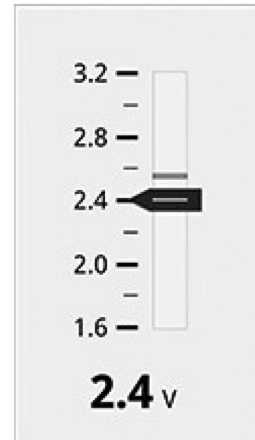

Sensor Voltage

Current Voltage Indicator - voltage reading from sensor.



Black Marker

Current Voltage Value - voltage is also displayed numerically at the bottom of the indicator.



Current Voltage Value

NOTE: If Current Voltage Value is red, then current reading is outside the acceptable range.

Boom Calibration | Tilt Sensors

This procedure calibrates the boom tilt sensors. Tilt sensors must be calibrated so that automatic boom fold/unfold and Return to Height operate correctly.

SECTION 6 – CALIBRATIONS



Perform Calibration When:

- Automatic boom fold/unfold is not operating correctly.
- Return to Height feature for tilt is not working properly.
- Sensor has been replaced.

Details Displayed on Page:

Last Calibration:	Date and Time
Recommended Interval:	As Needed
Estimated Time Required:	Approx. 1 Minute

Readings Displayed on Page:

Sensor Voltages - displays the current voltage reading and the voltage range of the left and right-hand tilt sensors.

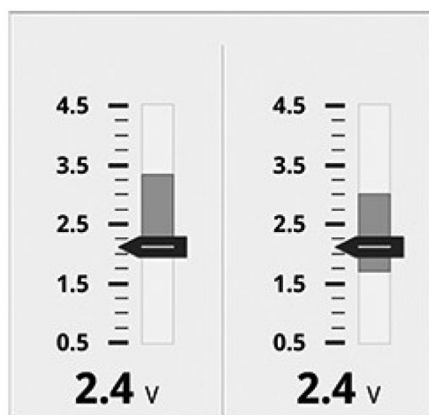

Sensor Voltages

Tilt Sensor Calibration Procedure

Procedure Requirements:

Engine State:	Running
Wheel Speed:	0 km/h (0 mph)
Operating State:	Parked, Not Applying Product

⚠ CAUTION

Spray booms move quickly. Keep all bystanders out of the folding and unfolding area of the spray booms. Failure to comply can result in injury or death.

IMPORTANT: Booms can contact and may damage the exhaust stack and/or walkway handrail when using manual mode to fold and unfold booms. Do not allow booms to go higher than the top of the cradle support when operating boom in manual mode.

1. Press the Calibrate Button to begin procedure.



Calibrate

2. Follow messages on-screen to complete procedure.
3. Press the Save Button to confirm calibration.



Save

If Calibration Fails:

1. Press the Retry Button.



Retry

2. Verify all requirements listed on-screen have been met.
3. If calibration fails twice, see your John Deere dealer or qualified service provider.

Tilt Sensor | Sensor Voltages

Sensor Voltages displays the readings from the spray boom tilt sensors. Sensor voltages can be used when diagnosing spray boom movement problems.

Items Accessible on Sensor Voltages Page:

Left-Hand Tilt Raised - voltage recorded with the spray boom wing raised.

3.6 v

Raised

Left-Hand Tilt Lowered - voltage recorded with the spray boom wing lowered.

1.6 v

Lowered

Left-Hand Tilt Range - range between raised and lowered voltage readings.

2.0 v

Range

Right-Hand Tilt Raised - voltage recorded with the spray boom wing raised.

3.6 v

Raised

Right-Hand Tilt Lowered - voltage recorded with the spray boom wing lowered.

1.6 v

Lowered

Right-Hand Tilt Range - range between raised and lowered voltage readings.

2.0 v

Range

NOTE: If readings are displayed in red, then that reading is outside the allowable range.

Boom Calibration | Tilt Valves

This procedure calibrates the boom tilt valves. Tilt valves must be calibrated so that the boom response is the correct speed and NORAC® operates correctly when installed.

Perform Calibration When:

- Boom tilt response is too slow or fast.
- A valve cartridge has been replaced.
- NORAC® is not performing as expected.
- Boom tilt cylinders are replaced.

Details Displayed on Page:

Last Calibration:	Date and Time
Recommended Interval:	As Needed
Estimated Time Required:	1 Minute

Readings Displayed on Page:

- Value Amps - displays tilt valve amperage value for boom tilt movement on right and left-hand boom wings.

Tilt Valve Calibration Procedure

Procedure Requirements:

Engine State:	Running
Wheel Speed:	0 km/h (0 mph)
Operating State:	Parking, Not Applying Product
Boom State:	Unfolded

⚠ CAUTION

Spray booms move quickly. Keep all bystanders out of the folding and unfolding area of the spray booms. Failure to comply can result in injury or death.

IMPORTANT: Booms can contact and may damage the exhaust stack and/or walkway handrail when using manual mode to fold and unfold booms. Do not allow booms to go higher than the top of the cradle support when operating boom in manual mode.

IMPORTANT: This procedure requires unfolding the inner boom and will automatically control tilt valves. Ensure adequate space is available.

1. Press the Calibrate Button to begin procedure.



Calibrate

2. Follow messages on-screen to complete procedure.

3. Press the Save Button to confirm calibration.



Save

If Calibration Fails:

1. Press the Retry Button.



Retry

2. Verify all requirements listed on-screen have been met.
3. If calibration fails twice, see your John Deere dealer or qualified service provider.

NOTE: If readings are displayed in red, then the reading is outside the allowable range.

Tilt Valve Calibration | Manual Adjustment

Manual tilt valve calibration adjustment allows you to enter customized calibration values if calibration procedure does not provide the desired machine function.

Use Manual Tilt Valve Calibration Adjustment When:

- Boom reactions are unsatisfactory after response time adjustments have been made.
- Requiring more hydraulic flow for faster reactions, increase the values.
- Requiring less hydraulic flow for slower reactions, decrease the values.

Manually Adjust Tilt Valve Calibration Procedure:

IMPORTANT: Calibration procedures allow for optimal machine performance. Adjustments to these values may be necessary, depending on field conditions. Improper adjustment may negatively affect system performance or damage machine. Do not manually adjust calibration values

without instruction or supervision from your John Deere dealer or qualified service provider.

1. Press the Manually Adjust Button.



Manually Adjust

2. Select desired input box.
3. Enter desired value using keypad.



Manually Adjust

4. Press the OK Button to confirm.



OK

5. Press the Close Button to return to previous page.



Close

Reset Calibrations | Boom Calibrations

This procedure resets all boom calibration values to the factory defaults.

Perform When:

- Accurate calibration values cannot be achieved.
- Major boom structure components are replaced.

Reset Boom Calibration Procedure

IMPORTANT: This process cannot be undone. Once calibrations have been reset, you will have to perform each calibration again.

1. Press the Reset Button.



Reset

2. The following calibrations are reset:
 - Center Frame
 - Tilt Sensor (if equipped)
 - Tilt Valve (if equipped)
 - Auto Boom Fold/Unfold (if equipped)
 - Boom Level Position

3. Press the OK Button to reset calibrations.



OK

4. Press the Cancel Button to return to previous page.



Cancel

Spray Calibration | Flow Meters

This procedure calibrates the flow meters. The flow meters must have the correct calibration numbers entered in order to provide the desired application rate.

Perform Calibration When:

- Flow meter(s) have been replaced.
- Actual application is not equal to target application rate.

NOTE: Flow Meter 2 is the outer flow meter with an in-line shutoff valve.

SECTION 6 – CALIBRATIONS



Details Displayed on Page:

Last Calibration:	Date and Time
Recommended Interval:	As Needed
Estimated Time Required:	< 1 Minute

Flow Meter Calibration Procedure

NOTE: Input for flow meter calibration is defaulted from factory for the actual flow meter installed. Calibration is only required if an aftermarket flow meter is installed.

Procedure Requirements:

Engine State:	Key ON
Wheel Speed:	0 km/h (0 mph)
Operating State:	Parked, Not Applying Product

1. Select input box for desired flow meter (1 or 2).



Flow Meter

2. Enter calibration value using keypad.

NOTE: Calibration values are stamped on tags attached to the flow meters.

NOTE: Actual flow meter position must correspond with the selected input box. Flow Meter 2 is used for high-flow applications.

3. Press the OK Button to reset calibrations.



OK

Spray Calibration | Pressure Sensors

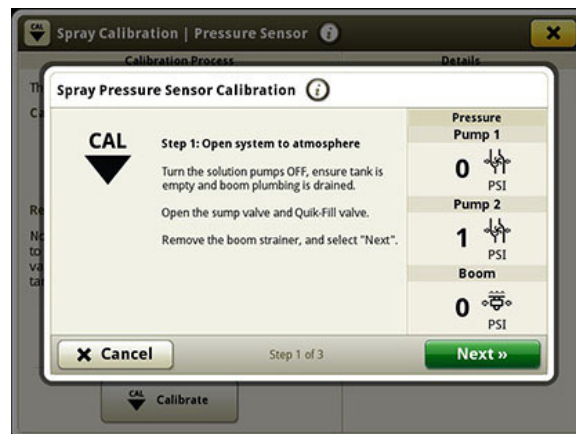

Spray Pressure Sensor Calibration Page

This procedure calibrates the pressure sensors for the solution system.

NOTE: This procedure requires exposing the system to the atmosphere by opening the sump and Quik-Fill™ valves and removing the solution strainers. Ensure that the solution tank is empty and boom plumbing is drained before performing procedure.

Perform Calibration When:

- Pressure sensor reading does not return to 0 when system is open to atmosphere.
- The pressure sensor has been replaced.
- Applied rate does not equal target rate.
- Boom pressure relief does not function.

Details Displayed on Page:

Last Calibration:	Date and Time
Recommended Interval:	As Needed
Estimated Time Required:	More than 5 minutes

Readings Displayed on Page:

Solution Pump Pressure - displays system pressure at solution pumps (Pumps 1 and 2).

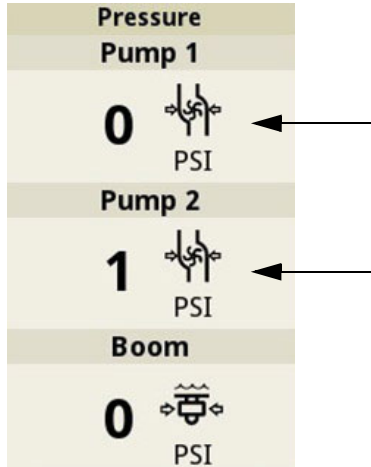

Solution Pump Pressures

Spray Boom Pressure - displays system pressure in the spray boom.

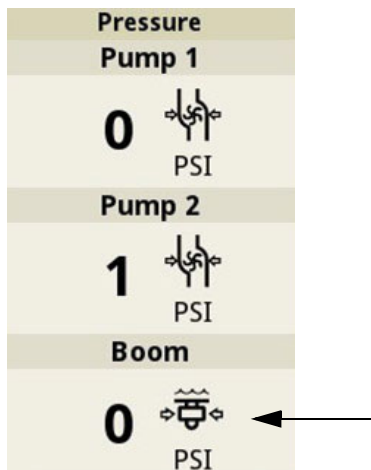

Spray Boom Pressure

**Pressure Sensor Calibration
Procedure**

Procedure Requirements:

Engine State:	Engine OFF, key in "Run" position
Wheel Speed:	0 km/h (0 mph)
Operating State:	Parked, not applying product
Solution System:	Empty and open to atmosphere

⚠ CAUTION

Do not drain solution onto the ground. Drain into a container. Drain solution in an area where people, animals, vegetation, and water supply cannot be contaminated.

1. Press the Calibrate Button to begin procedure.



Calibrate

2. Follow messages on-screen to complete procedure.
3. Press the Save Button to confirm calibration.



Save

If Calibration Fails:

1. Press the Retry Button.



Retry

2. Verify all requirements listed on-screen have been met.
3. If calibration fails twice, see your John Deere dealer or qualified service provider.

If current voltage value is red, then current reading is outside the calibrated range.



Current Voltage Value

Spray Calibration | Solution Pumps

This procedure calibrates the solution pumps. Solution pumps must be calibrated in order to achieve the desired application rate and maintain the desired solution pressure.

Perform Calibration When:

- Solution pump is replaced.
- Hydraulic motor assembly is replaced.
- Proportional valve is replaced.
- Hydraulic combo valve is replaced.
- Spray rate control unit is replaced.
- Pump values A and B are not within correct ranges.

Details Displayed on Page:

Last Calibration:	Date and Time
Recommended Interval:	As Needed
Estimated Time Required:	Approx. 5 Minutes

Readings Displayed on Page:

- Pump - displays A and B readings for low and high pump operating speeds and electrical current from the sensor.

Solution Pump Calibration Procedure

Procedure Requirements:

Engine State:	Running at low idle
Wheel Speed:	0 km/h (0 mph)
Operating State:	Parked, not applying product
Hydraulic Fluid Temperature:	Normal operating temperature
Solution System:	<ul style="list-style-type: none"> • Contains enough water to prevent pump cavitation (minimum volume - 567.8L/150 gal) • Solution pumps OFF. • System pressure less than 34.4 kPa/ 0.34 bar/5 psi

NOTE: Do not perform this procedure for erratic solution pump rate of pressure if the A and B numbers are within range. If A and B numbers are within range, see operator's manual.

NOTE: Perform calibration using ONLY water. Using other solutions causes inaccurate calibration values.

	Speed (rpm)	Current (mA)
A	800-1400	350-650
B	5500-6000	1275-1625

1. Press the Calibrate Button to begin procedure.



Calibrate

NOTE: The Next Button is disabled when requirements listed on-screen are not met.

2. Follow messages on-screen to complete procedure.
3. Press the Save Button to confirm calibration.



Save

If Calibration Fails:

1. Press the Retry Button.



Retry

2. Verify all requirements listed on-screen have been met.
3. If calibration fails twice, see your John Deere dealer or qualified service provider.

Reset Calibrations | Spray Calibrations

This procedure resets all machine calibration values to the factory defaults.

Perform When:

- Accurate calibration values cannot be replaced.
- Major machine components are replaced.

Reset Spray Calibration Procedure

NOTE: This process cannot be undone. Once calibrations have been reset, you will have to perform each calibration again.

1. Press the Reset Button.



Reset

2. The following calibrations are reset:
 - Flow Meters
 - Pressure Sensors
 - Solution Pumps
3. Press the OK Button to reset calibrations.



OK

4. Press the Cancel Button to return to previous page.



Cancel



SECTION 7 – RINSE SYSTEM

Information in this manual pertains to the Hagie Liquid System installed on your machine. Refer to your machine operator's manual for complete information on CommandCenter™ display features and operating instructions.

Access Rinse System

Access Application Through Display

1. Press the Menu Button.



Menu Button

2. Press the Machine Settings Tab.



Machine Settings Tab

3. Press the Rinse System Button.



Rinse System Button

Access Application Through Navigation Bar

Press Rinse System Button on navigation bar below display.

Rinse System Main Page

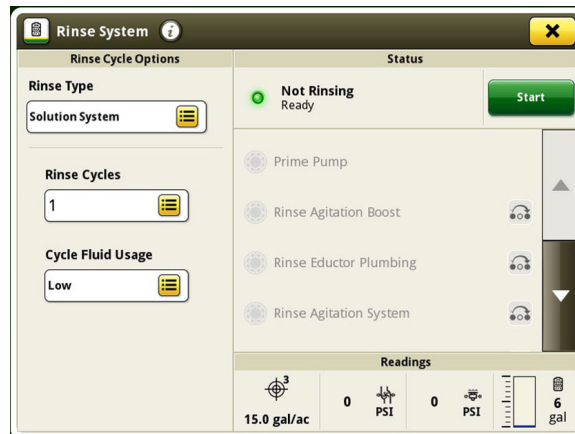

Rinse System Main Page

NOTE: Underscored text identifies that additional information is available within this section or another section of this publication.

NOTE: Main page shown is for example only. Your main screen may differ, depending on options or connected equipment.

Rinse System application allows you to choose the desired rinse mode and configure rinse system settings. Solution system components must be rinsed to avoid crop damage, contamination from chemicals, and machine damage.

Perform Rinse Procedure When:

- Applying to different crops.
- Changing product mixes.
- Repairing or servicing machine.
- Preparing machine for storage.

Select Rinse Type Procedure:

Select to choose the desired rinse type from the following options:

- Boom Only - rinses solution pumps, flow meters, and boom plumbing.
- Solution System - rinses all solution system plumbing, solution tank, solution pumps, flow meters, and boom plumbing.

SECTION 7 – RINSE SYSTEM



- Solution Tank Only - rinses only the solution tank.
- Rinse Tank Transfer - transfers rinse water to the solution tank. No rinsing occurs.



Rinse Type

Rinse System (Boom Only)

Boom Only rinse allows you to remove spray solution from the solution pumps, flow meters, and boom plumbing when the solution tank still contains spray solution.

Perform Boom Only Rinse When:

- Before servicing solution pumps, flow meters, or boom plumbing.
- As necessary to clean nozzle bodies and prevent tip plugging.

Items Accessible on Rinse System (Boom Only) Page:

Rinse Type - displays current rinse type selected.

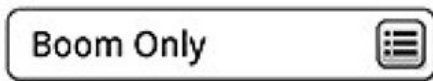

Rinse Type - Boom Only

Target Rate - change selected target rate. Adjust target rate as desired to avoid crop damage when rinsing in the field.



Target Rate

Status Indicator - displays status of the rinse procedure.

- **Green** - Not Rinsing/Transferring (rinse/transfer procedure has not been started)
- **Blue** - Rinsing Active (rinse procedure in process)
- **Blue** - Transferring (rinse tank transfer in process)
- **Amber** - Not Rinsing (rinse process is stopped. Action required to continue)

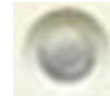

Status Indicator

Progress Indicator - displays the rinse step in progress. Rotating indicator means that the listed components are currently being rinsed.



Progress Indicator

Checkmark - indicates completed steps.



Checkmark

Step Aborted - process was aborted during the current step.



Abort

Solution Pump Pressure - solution pressure at the pump sensor.



Solution Pump Pressure

Boom Pressure - solution pressure at the boom sensor.



Boom Pressure

Boom Only Rinse Procedure

⚠ CAUTION

Spray System can contain hazardous material, which can cause serious injury or death to you or others. Wear protective clothing, eyewear, and gloves. Operate Rinse System in an area where people, animals, vegetation, and water supply cannot be contaminated.

IMPORTANT: During the boom rinse cycle, a warning message may appear stating that there is not enough pressure and the boom rinse procedure may need to be split to where only one or two sections of the boom are rinsed at a time. This may likely be due to the large spray tips used with the floater application and does not allow the system to maintain enough back-pressure on the pump. Turn boom sections OFF to where no more than two (2) sections are on at a time.

IMPORTANT: Chemical buildup in section end caps can occur if not cleaned out thoroughly and regularly, especially when using “combo” boom plumbing. To clean, close all nozzles and cam-locks. Remove end caps and cams on the ends of the spray pipes and flush with water.

NOTE: Engine speed reverts to the previous level when solution pump(s) are turned OFF if throttle position has not been adjusted.

NOTE: Rinse System can be operated from the load station using the keypad. See your operator’s manual for further information.

1. Verify that desired boom sections are enabled.
2. Press the Start Button. Solution pump priming begins.

NOTE: End rinse procedure by pressing the Abort Button at any time.

NOTE: A checkmark is displayed next to each step once complete.



Start Button

3. Press the Solution Pump Switch on the CommandARM™ to turn the solution pumps ON.

NOTE: Select either Standard/Low Flow (1 pump), or High Flow (2 pumps) through the Flow Rate Mode Page. The Solution Pump Switch on the CommandARM will then enable/disable the pumps selected.



Solution Pump Switch

4. Press the Spray System Master Switch on the multi-function lever to begin boom rinsing.



Spray System Master Switch

The rinse process will end automatically when the pump is detected as running dry.

NOTE: A message confirming “boom rinse complete” appears on-screen and can be viewed in the Status Center on the display.

5. Close all nozzle bodies not on an aspirator (see operator’s manual for further information).
6. Set aspirator nozzles to open positions (see operator’s manual for further information).
7. Press the Start Button to perform a second boom rinse.

NOTE: Rinse only one boom section at a time for approximately 5-10 seconds until all sections are flushed. Rinsing all sections at once may not produce enough system pressure to properly flush boom plumbing. Active boom sections must be controlled from the cab using the Boom and Nozzles application or the section shutoff encoders on the CommandARM™.

NOTE: The rinse process will end automatically when the pump is detected as running dry.

8. Return nozzle bodies to previous positions.

Rinse System (Solution System)

Solution System rinse allows you to clean spray solution from the solution system and boom.

Perform Solution System Rinse When:

- Before servicing the solution system.
- Changing chemicals being applied.
- Changing crop being sprayed.

Items Accessible on Rinse System (Solution System) Page:

Rinse Type - displays the current rinse type selected.



Rinse Type - Solution System

Rinse Cycles - number of rinse cycles desired.



Rinse Cycles

Cycle Fluid Usage - volume of fluid used during each rinse cycle.



Cycle Fluid Usage

Skip Button - advances procedure to the next component before current component is finished rinsing.



Skip Button

Target Rate - change selected target rate. Adjust target rate as desired to avoid crop damage when rinsing in the field.



Target Rate

Status Indicator - displays status of the rinse procedure.

- **Green** - Not Rinsing/Transferring (rinse/transfer procedure has not been started)
- **Blue** - Rinsing Active (rinse procedure in process)
- **Blue** - Transferring (rinse tank transfer in process)
- **Amber** - Not Rinsing (rinse process is stopped. Action required to continue)



Status Indicator

Progress Indicator - displays the rinse step in progress. Rotating indicator means that the listed components are currently being rinsed.



Progress Indicator

Checkmark - indicates completed steps.



Checkmark

Step Aborted - process was aborted during the current step.



Abort

Solution Pump Pressure - solution pressure at the pump sensor.



Solution Pump Pressure

Boom Pressure - solution pressure at the boom sensor.



Boom Pressure

Solution System Rinse Procedure

⚠ CAUTION

Spray System can contain hazardous material, which can cause serious injury or death to you or others. Wear protective clothing, eyewear, and gloves. Operate Rinse System in an area where people, animals, vegetation, and water supply cannot be contaminated.

NOTE: Engine speed reverts to the previous level when solution pump(s) are turned OFF if throttle position has not been adjusted.

NOTE: Rinse System can be operated from the load station using the keypad. See your operator's manual for further information.

IMPORTANT: To rinse entire system, solution tank must be empty.

SECTION 7 – RINSE SYSTEM



1. Verify that desired boom sections are enabled. See Boom and Nozzles Main Page.
2. Select desired number of rinse cycles from the Rinse Cycle display box.



Rinse Cycles

3. Select desired cycle fluid usage from the Cycle Fluid display box.



Cycle Fluid Usage

4. Verify that both solution pumps are OFF.
5. Press the Start Button.

NOTE: Solution System rinse turns on both solution pumps automatically, regardless of spray mode.

NOTE: End rinse procedure by pressing the Abort Button at any time during the procedure.

NOTE: A checkmark is displayed next to each step once complete.



Start Button

NOTE: If desired, press the Skip Button to advance to the next step in procedure.



Skip Button

6. Press the Spray System Master Switch on the multi-function lever. Rinse solution is sprayed through the boom.



Spray System Master Switch

NOTE: Rinse system advances to the next step, or ends automatically after the last cycle.

7. A message confirming “system rinse complete” appears on-screen and can be viewed in the Status Center on the display.
8. Perform a Boom Only rinse.

Rinse System (Solution Tank Only)

Solution Tank Only rinse allows you to rinse the solution tank (and pumps) without rinsing any other systems.

Perform Solution Tank Only Rinse When:

- Spray off rinse solution is not possible.

Items Accessible on Rinse System | Solution Tank Only Page:

Rinse Type - displays the current rinse type selected.



Rinse Type - Solution Tank Only

Items Displayed on Page:

Status Indicator - displays status of the rinse procedure.

- **Green** - Not Rinsing/Transferring (rinse/transfer procedure has not been started)
- **Blue** - Rinsing Active (rinse procedure in process)
- **Blue** - Transferring (rinse tank transfer in process)
- **Amber** - Not Rinsing (rinse process is stopped. Action required to continue)



Status Indicator

Progress Indicator - displays the rinse step in progress. Rotating indicator means that the listed components are currently being rinsed.



Progress Indicator

Checkmark - indicates completed steps.



Checkmark

Step Aborted - process was aborted during the current step.



Abort

Solution Pump Pressure - solution pressure at the pump sensor.



Solution Pump Pressure

Boom Pressure - solution pressure at the boom sensor.



Boom Pressure

Solution Tank Only Rinse Procedure

⚠ CAUTION

Spray System can contain hazardous material, which can cause serious injury or death to you or others. Wear protective clothing, eyewear, and gloves. Operate Rinse System in an area where people, animals, vegetation, and water supply cannot be contaminated.

NOTE: Engine speed reverts to the previous level when solution pump(s) are turned OFF if throttle position has not been adjusted.

NOTE: Rinse System can be operated from the load station using the keypad. See your operator's manual for further information.

IMPORTANT: Solution tank must be empty before rinsing.

1. Verify that both solution pumps are OFF.
2. Press the Start Button.



Start Button

NOTE: End rinse procedure by pressing the Abort Button at any time before completion.



Abort Button

3. Procedure ends automatically when complete.
4. A message confirming “complete rinse cycle” appears on-screen and can be viewed in the Status Center on the display.

NOTE: Solution tank must be emptied by draining into a suitable container or by spraying out through the boom.

Rinse System (Rinse Tank Transfer)

Rinse Tank Transfer allows you to transfer the rinse tank contents to the solution tank without rinsing any systems.

Perform Rinse Tank Transfer When:

- Extra solution is needed to complete application job.

Items Accessible on Rinse System | Rinse Tank Transfer Page:

Rinse Type - displays the current rinse type selected.



Rinse Type - Rinse Tank Transfer

Items Displayed on Page:

Status Indicator - displays status of the rinse procedure.

- **Green** - Not Rinsing/Transferring (rinse/transfer procedure has not been started)
- **Blue** - Rinsing Active (rinse procedure in process)
- **Blue** - Transferring (rinse tank transfer in process)
- **Amber** - Not Rinsing (rinse process is stopped. Action required to continue)



Status Indicator

Progress Indicator - displays the rinse step in progress. Rotating indicator means that the listed components are currently being rinsed.



Progress Indicator

Checkmark - indicates completed steps.



Checkmark

Step Aborted - process was aborted during the current step.



Abort

Solution Pump Pressure - solution pressure at the pump sensor.



Solution Pump Pressure

Boom Pressure - solution pressure at the boom sensor.



Boom Pressure

NOTE: Transfer procedure can be ended by selecting the Abort Button at any time before completion.



Abort Button

Rinse Tank Transfer Procedure

⚠ CAUTION

Spray System can contain hazardous material, which can cause serious injury or death to you or others. Wear protective clothing, eyewear, and gloves. Operate Rinse System in an area where people, animals, vegetation, and water supply cannot be contaminated.

3. Procedure ends automatically when complete.
 4. A message confirming “tank transfer complete” appears on-screen and can be viewed in the Status Center on the display.
-

NOTE: Engine speed reverts to the previous level when solution pump(s) are turned OFF if throttle position has not been adjusted.

NOTE: Rinse System can be operated from the load station using the keypad. See your operator’s manual for further information.

1. Verify that both solution pumps are OFF.
2. Press the Start Button.



Start Button



SECTION 8 – LIQUID SYSTEM

Information in this manual pertains to the Hagie Liquid System installed on your machine. Refer to your machine operator's manual for complete information on CommandCenter™ display features and operating instructions.

Access Liquid Application System

3. Press the Spray System Button.



Spray System Button

Access Application Through Navigation Bar

Press Spray System Button on navigation bar below display.

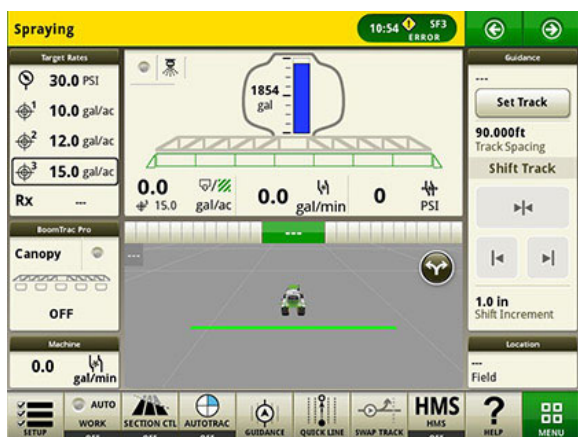

Main Run Page

Spray System Main Page

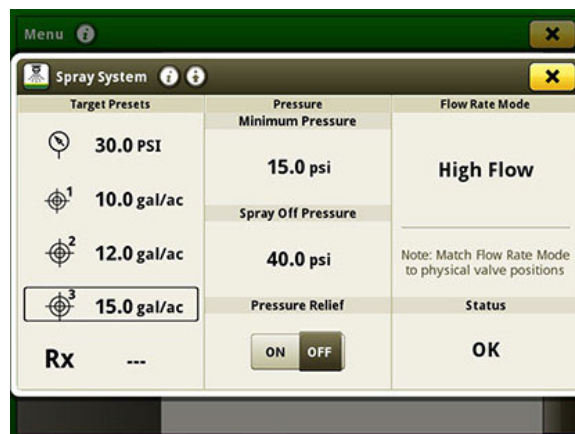

Spray System Main Page

Access Application Through Display

1. Press the Menu Button.



Menu Button

2. Press the Machine Settings Tab.



Machine Settings Tab

NOTE: Underscored text identifies that additional information is available within this section or another section of this publication.

NOTE: Main page shown is for example only. Your main page may differ, depending on options or connected equipment.

Liquid System application allows you to configure the liquid system controls to ensure proper application of solution.

Modify When:

- Changing application rates.

SECTION 8 – LIQUID SYSTEM



- Higher levels of agitation are needed.
- Application rate requires a change to flow valve configuration.

Items Accessible on Spray System Main Page:

Target Presets/Rx - Edit Target Rate, Manual Pressure, or prescription for liquid application control.

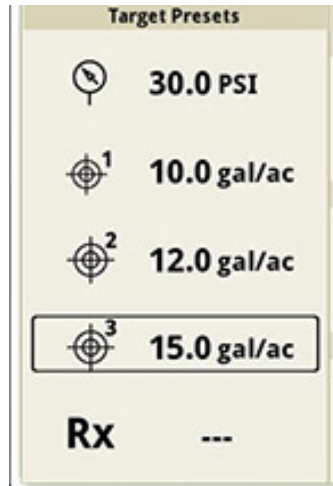

Target Presets

Minimum Pressure - Pressure maintained while spraying.

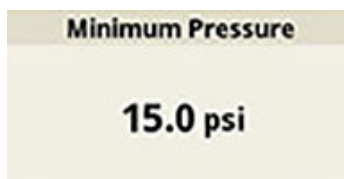

Minimum Pressure

Spray Off Pressure - Pressure maintained while not spraying (but with pump(s) running).

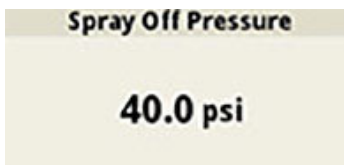

Spray Off Pressure

Pressure Relief - Relieve pressure in booms to the tank.



Pressure Relief

Flow Rate Mode - Current flow rate mode selected.

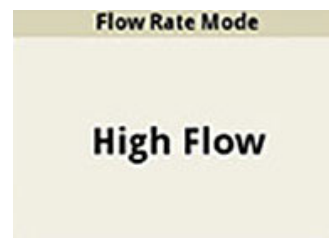

Flow Rate Mode

Status - Informs you if adjustment to the physical valve positions or liquid system settings are needed.



Status

Advanced Settings - Access further adjustments and less common settings.



Advanced Settings

Minimum Pressure

Minimum Pressure is maintained when spray pressure for desired application rate is too low. This pressure setting must be higher than the nozzle tip size selected and higher than the nozzle check valve pressure to keep all check valves open, but not too high to prevent over application during normal speed adjustments in the field.

Modify When:

- Changing carrier solutions.
- Nozzle check valves are changed.
- Spray tip size or type is changed.

Minimum Pressure Modification Procedure

1. Fill solution tank with carrier to be used.
2. Unfold booms (see 27.4 m/90 ft Booms section for boom unfolding instructions).
3. Enable all spray sections (see Boom and Nozzles application in the Booms section for further information).
4. Select the Minimum Pressure area on the Spray System Main Page.

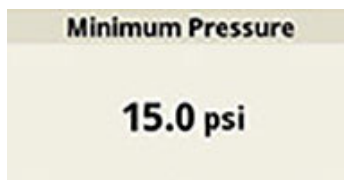

Minimum Pressure

5. Set Minimum Pressure to 0.
6. Select OK to confirm.



OK

7. Select the Spray Off Pressure area on the Spray System Main Page.



Spray Off Pressure

8. Set Spray Off Pressure to 0.
9. Select OK to confirm.



OK

10. Press the Manual Rate Switch on the CommandARM™.



Manual Rate Switch

11. Press the Solution Pump Switch on the CommandARM™ to turn the solution pump(s) ON.

NOTE: Select either *Standard/Low Flow (1 pump)*, or *High Flow (2 pumps)* through the *Flow Rate Mode Page*. The *Solution Pump Switch* on the *CommandARM* will then enable/disable the pumps selected.

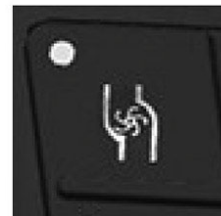

Solution Pump Switch

12. Press the Spray System Master Switch to begin spraying.



Spray System Master Switch

13. Increase Manual Target Preset by 6.9 kPa (0.7 bar) (1 psi) increments until all nozzle body check valves open and all nozzles are spraying at full pattern. Record pressure when this occurs.

14. Select the Minimum Pressure area on the Spray System Main Page.

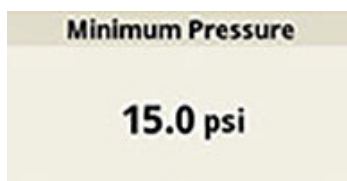

Minimum Pressure

15. Enter previously recorded pressure.

16. Select OK to confirm.



OK

Target Rate/Rx

Target application rate can be edited for presets 1, 2, and 3. The pressure setting for use with the manual rate setting can also be modified. A prescription for map-based application can be selected if previously loaded to machine.

Modify When:

- Changing products being applied.
- Prescription application is desired.
- Manual rate control is desired.

- Application rate desired is not one of the current presets.

Target Rate Modification Procedure

1. Select desired rate preset on the Spray System Main Page.

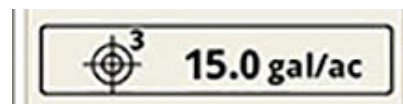

Rate Preset

2. Enter rate using keypad.
3. Select OK to confirm.



OK

4. Select Close Button to return to previous page.



Close

Manual Pressure Modification Procedure

1. Select Manual Pressure on the Spray System Main Page.



Manual Pressure

2. Enter pressure using keypad.
3. Select OK to confirm.



OK

- Select Close Button to return to previous page.

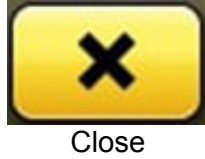

Prescription Modification Procedure

NOTE: Prescriptions must be loaded to the display from an external source. You cannot create a prescription on the display.

- Select Rx on the Spray System Main Page to change prescription.

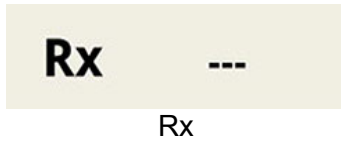

- Edit prescription through the Work Setup Page (see Work Setup in your machine operator’s manual for further information).

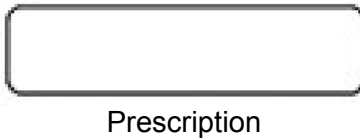

- Select OK to confirm.



Flow Rate Mode

Flow Rate Mode allows you to choose between High, Standard, and Low-Flow rate. Correct flow rate must be selected to obtain the desired application rate.

Modify When:

- Changing application rates.

- Application speed changes significantly.

Flow Rate Mode Modification Procedure

- On the Main Run Page, touch anywhere in the circled area below to navigate to the Spray System Main Page.



- On the Spray System Main Page, touch anywhere in the Flow Rate Mode box to modify.



- On the Flow Rate Mode Page, press the Recommendations Button to calculate the correct flow rate mode for your application. Otherwise, select desired setting (High Flow, Standard Flow, or Low Flow).

NOTE: High Flow mode uses both solution pumps and both flow meters. Standard and Low Flow mode use only one solution pump and one flow meter.



Recommendations Button

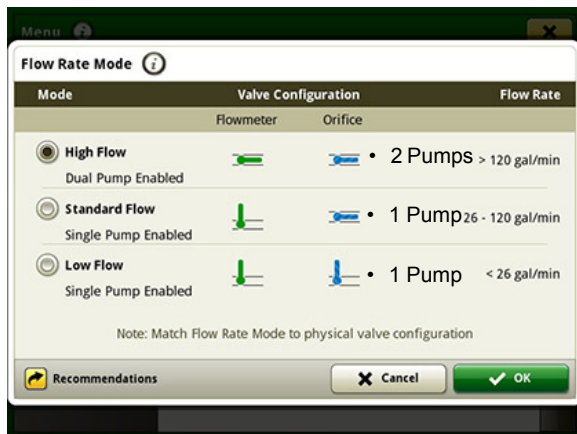

The Liquid System is equipped with two (2) electric boom isolation valves for standard and high-flow applications. When standard flow is selected on the Flow Rate Mode Page, the Standard Flow Valve (A) is active. When high flow is selected, both the Standard Flow Valve (A) and High-Flow Valve (B) are active. The manual Orifice Valve (C) is provided for Low-Flow application.

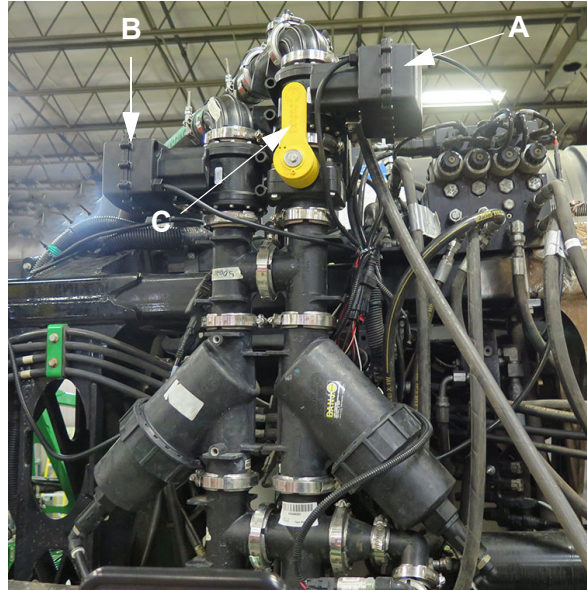

Boom Isolation Valves

- (A) - Electric Standard Flow Valve
- (B) - Electric High Flow Valve
- (C) - Orifice Valve (Low Flow Application)



Flow Recommendations

Flow Recommendations determine the correct flow rate mode and valve positions for the desired application rate and speed.

- Select OK to confirm.



OK

Calculate Flow Recommendations Procedure

1. Press anywhere in the Flow Rate Mode box on the Spray System Main Page.



Flow Rate Mode

2. Select Recommendations.



Recommendations

3. Select Working Speed.

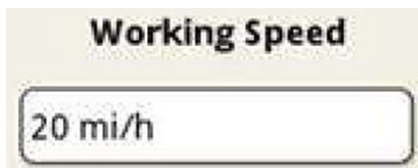

Working Speed

4. Enter anticipated working speed using keypad.
5. Select OK to confirm.



OK

6. Select Target Rate.



Target Rate

7. Enter desired application rate using keypad.
8. Select OK to confirm.



OK

NOTE: Display calculates and shows recommendations.

9. Select Close when finished viewing recommendations.



Close

Spray Off Pressure

Spray Off Pressure is the pressure the solution pump maintains when not spraying. Spray Off Pressure is primarily intended to increase agitation when not spraying. It should not be used as a means for boom charge compensation.

Increase Spray Off Pressure When:

- Applying dry flowable, heavy, or thick liquid chemicals.
- You desire increased agitation pressure.

Decrease Spray Off Pressure When:

- Using easily foaming chemicals.
- High agitation rates are not necessary to keep solution mixed.

Spray Off Pressure Modification Procedure

1. Select Spray Off Pressure on the Spray System Main Page.

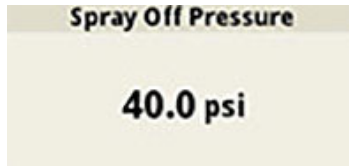

Spray Off Pressure

2. Enter desired pressure using keypad.
3. Select OK to confirm.



OK

4. Select Cancel to exit without making a change.



Cancel

Pressure Relief

The Boom Pressure Relief function allows the pressure trapped in the boom to be bled off after spraying is complete. The main purpose of this function is to minimize the possibility of the sprayer nozzle bodies leaking while in transit.

⚠ CAUTION

Avoid unintended spray from nozzles. Do not use when non-Hagie aftermarket solution system equipment is installed. These include, but are not limited to, direct injection and section control systems.

Boom Pressure Relief Procedure

1. Press Boom Pressure Relief on the Spray System Main Page to ON.



Pressure Relief

2. Press the Boom Raise/Lower Switch on the multi-function lever to raise the boom center frame to highest position.



Boom Raise/Lower Switch

3. Verify that solution system pressure is 27 kPa (0.27 bar) (4 psi).
4. Enable all boom sections (see [Boom and Nozzles](#) application in the Booms section for further information).
5. Press the Spray System Master Switch. Section valves open for three (3) seconds to relieve pressure.

NOTE: Section valves automatically close after three (3) seconds.



Spray System Master Switch

Advanced Settings (Rate Control/Display Speed, Boom Charge, Spray System Response)

Advanced Settings allows access to further adjustments and less common settings, such as Rate Control/Display Speed, Boom Charge, and Spray System Response.

Modify When:

- Field conditions change.
- Solution does not respond to rate changes as desired.
- Solution rate does not reach the target rate quickly after spray system master switch is turned ON.

To Access the Advanced Settings Page:

Press the Advanced Settings icon along the top right-hand side of the Spray System Main Page.



Advanced Settings

Items Accessible on Advanced Settings Page:

Rate Control/Display Speed - Current speed source for the spray rate control unit.

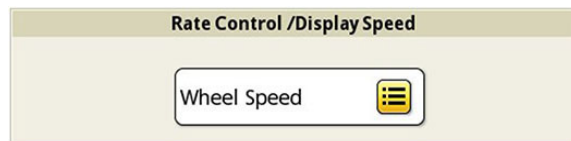

Rate Control/Display Speed

Boom Charge - Desired mode of operation.

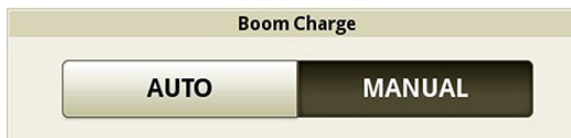

Boom Charge

Spray System Response - Swipe LEFT (turtle icon) to decrease, or RIGHT (rabbit icon) to increase spray system response.



Spray System Response

Rate Control/Display Speed

The correct speed source must be selected in order for the spray rate control unit to achieve the desired spray rate. Speed source must be adjusted based on ground conditions, availability of Global Positioning System (GPS) signal, and options installed.

Available Speed Sources

GPS Speed

Select as the speed source when:

- Wheel slip is likely to occur.
- Radar is not installed.
- In tall crop conditions that cause poor radar signal.

Wheel Speed

Select as the speed source when:

- Radar is not installed.
- GPS signal is degraded.
- In tall crop conditions that cause poor radar signal.
- Wheel slip is not likely to occur.

Boom Charge

Boom Charge will pressurize the boom plumbing to a preset value for three (3) seconds after the spray system master switch is turned ON. This compresses any air in the boom to ensure that the nozzles are spraying at the desired rate as soon as possible.

Select From One of the Following Modes

Automatic

Allows the system to charge the boom at an automatically predetermined pressure and flow. This is calculated by the control unit based on the previous speed, boom section width, and flow rate output with the spray system master switch OFF. It also allows the system to operate on a pressure-based application rate control versus a flow-based rate below 15 gal/min. This allows the spray rate control system to reach the target application rate faster when smaller flow rate nozzles are used. Use for normal spraying operations.

NOTE: It is also best to operate in this mode when using Gen 4 Section Control.

Manual

Allows the system to charge the boom at the Manual Target Pressure set for the rate select switch for three (3) seconds after the spray system master switch is turned ON. After three (3) seconds, the automatic rate control system will take over. This may cause over or under application if manual target pressure is not equal to spray speed after headland turns. Use when troubleshooting irregular application rates, such as when rates and speeds vary drastically at headlands.

Spray System Response

Spray System Response is the time it takes for the actual application rate to reach the target rate. Response setting must be correct to ensure that the correct application rate is achieved.

Increase Response When:

- Target Rate is never reached.
- Time to acquire Target Rate is longer than four (4) seconds.

Decrease Response When:

- Application rate is erratic.

Procedure to Modify:

- Swipe LEFT (turtle icon) to decrease, or RIGHT (rabbit icon) to increase desired sensitivity.

NOTE: The slider scale indicates speed of the response setting selected. In most cases, the Spray System Response should be set to three (3).



SECTION 9 – TANK SYSTEM

Information in this manual pertains to the Hagie Liquid System installed on your machine. Refer to your machine operator's manual for complete information on CommandCenter™ display features and operating instructions.

IMPORTANT: Maximum fill pump circuit pressure is 6.9 kPa (.07 bar) (50 psi). Exceeding this pressure will cause the fill pump case to crack.

Access Tank System

Access Application Through Display

1. Press the Menu Button.



Menu Button

2. Press the Machine Settings Tab.

Machine Settings Tab

3. Press the Tank System Button.



Tank System Button

Access Application Through Navigation Bar

Press Tank System Button on navigation bar below display.

Tank System Main Page

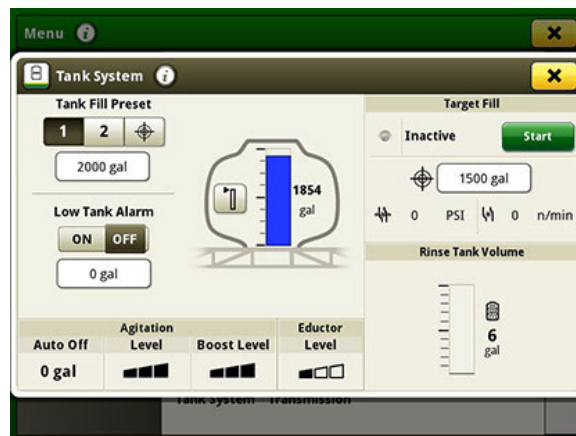

Tank System Main Page

NOTE: Underscored text identifies that additional information is available within this section or another section of this publication.

NOTE: Main page shown is for example only. Your main page may differ, depending on options or connected equipment.

Tank System application allows you to manage Solution Level, Agitation Level, Eductor Level, and Evacuation.

Modify When:

- Filling or adding solution to the tank.
- Changing low tank alarm level.
- Using target fill.
- Changing eductor and agitation levels.

SECTION 9 – TANK SYSTEM



Items Accessible on Tank System Main Page:

Tank Fill Preset - current solution tank level. Three preset levels are available. You can edit the preset volumes if the desired level is not available.



Tank Fill Preset

Low Tank Alarm - informs you that tank volume is below preset value. Press Low Tank Alarm Button to toggle alarm ON/OFF.



Low Tank Alarm Button

Current Tank Volume - displays the anticipated tank volume based on input and calculated solution usage or target fill sensor (if equipped).

NOTE: The operator can manually enter tank volume up to 2200 gal (8327 L) (maximum).



Current Tank Volume

Target Fill - automatically fills tank to desired level.



Target Fill

Status Indicator - displays status of Target Fill procedure. In addition, a message will appear about that status.

- **Green** - Active (Target Fill system is actively filling the solution tank)
- **Gray** - Inactive (Target Fill system is not active. If solution tank is being filled, you must monitor level using the sight gauge.



Status Indicator

Agitation - amount of solution flow during agitation.



Agitation

Eductor Level - amount of suction at the eductor.



Eductor Level

Run Page Modules

Modules for this application can be added to run pages using Layout Manager (see “Layout Manager” in your machine operator’s manual for further information).

Example:

Agitation Level - circulates solution in the tank to aid in keeping chemicals in suspension.

NOTE: Different shortcut keys can be available for your application.

Tank Fill Preset

Tank Fill Preset allows you to enter the current solution tank level using one of three presets. Tank Fill Preset must be used after adding solution to the tank to display the current tank volume accurately. Tank Fill Preset must be used to allow the low tank alarm to function properly and allow you to verify that proper application rates are being achieved.

The third button (target icon) on the toggle bar allows the operator to change the entry box to a “read-only” value. When the Reset Button (the tank graphic on the Tank System Main Page) is pressed, it will reset the tank level readout to whatever the level sensor in the tank is currently reading.

Modify When:

- Filling solution tank from empty.
- Adding to the solution in the tank.

Tank Fill Preset Procedure

1. Select desired Tank Fill Preset.

NOTE: Preset value is displayed in the input box.



Tank Fill Preset

2. If desired tank fill preset is not shown, then you can edit the presets (see [Edit Tank Fill Preset Procedure](#)).

Edit Tank Fill Preset

Edit Tank Fill Preset allows you to manually enter the current solution tank level if not available in the existing presets.

Modify When:

- Tank volume does not match the selected preset value.

Edit Tank Fill Preset Procedure

1. Select Tank Fill Preset on toggle bar to edit.

NOTE: The operator can manually enter tank volume up to 2200 gal (8327 L) (maximum).



Tank Fill Preset

2. Select input box and enter desired value using keypad. New value becomes the tank fill preset.

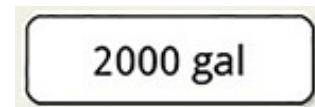

Preset Value

3. Select OK to confirm.



OK

Current Tank Volume

Current Tank Volume displays the anticipated solution tank volume based on your input and the calculated solution usage. You must reset the current tank volume every time solution is added to the tank using the Tank Fill Preset and editing as desired.

SECTION 9 – TANK SYSTEM



NOTE: The displayed volume is NOT the actual tank volume. Always verify tank volume using sight gauge on tank.

The following requirements must be met to provide an accurate tank volume:

- Correct Tank Fill Preset selected.
- Flow Meter Calibration correctly performed.
- Correct Flow Rate Mode selected.

Low Tank Alarm

An audible Low Tank Alarm alerts you that the solution tank volume is below the preset level. The alarm is used to indicate when to turn off agitation to reduce foaming, tank loading is needed, or when solution level is not sufficient for operating on hills.

Modify When:

- Changing solution level where alarm triggers.
- Terrain requires a certain amount of solution to maintain constant application.

Low Tank Alarm Procedure

1. Select Low Tank Alarm input box.



Low Tank Alarm Button

2. Enter desired preset value using keypad.
3. Select OK to confirm.



OK

Target Fill

The Target Fill system allows you to automatically fill the solution tank to desired level. The correct volume must be entered to ensure proper concentration of chemical and to have enough solution to complete your job.

NOTE: This application can only be used when the sprayer pump is being used to load the tank.

Modify When:

- Filling solution tank from empty.
- Adding solution to the tank.

Target Fill Procedure

1. Select the Target Fill Entry box to edit.



Target Fill Entry

2. Verify that desired fill level is shown in the input box.

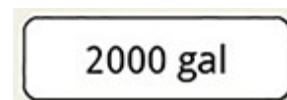

Preset Value

NOTE: If the Target Fill Preset is not displayed, you may edit. See Edit Target Fill Preset.

IMPORTANT: Verify that the nurse tank hose is connected to the machine and all necessary valves are open prior to filling the solution tank.

3. Select Start to begin filling the solution tank.

NOTE: The Start Button changes to “Stop” when selected.



Start

If necessary, select Stop to end Target Fill procedure before selected level is reached.



Stop

Edit Target Fill Preset

Edit Target Fill Preset allows you to enter the desired fill level if it is not displayed in the input box.

Modify When:

- Current preset does not match the desired fill level.

Edit Target Fill Preset Procedure

1. Select the Target Fill Entry box to edit.



Target Fill Entry

2. Select input box and enter desired value using the keypad.

NOTE: The new value becomes the target fill preset and is saved over key cycle.



Preset Value

3. Press OK to confirm.



OK

Agitation

Agitation circulates solution in the tank to aid in keeping chemicals in suspension. It is also used to mix chemical solution in the tank when required.

Modify When:

- Solution contents require more or less agitation.
- Manual agitation is desired (turn automatic agitation OFF).
- Reduce the risk of foaming at low solution levels (turn automatic agitation ON).

The system offers three agitation levels. Select from the following:

LOW - to minimize foaming with easily mixed product.

MEDIUM - for easily mixed products not likely to foam.

HIGH - to keep dry flowable and heavy or thick liquids in suspension.

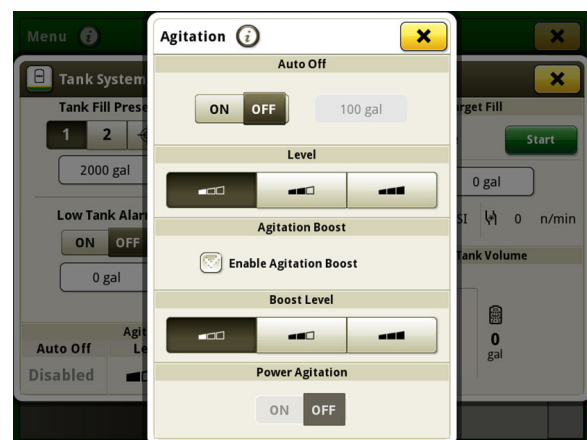

Agitation Settings Page

Auto Agitation Procedure

1. Press Auto ON using toggle button.



Auto On/Off

2. Select input box to change the solution tank level where agitation turns OFF using the keypad.

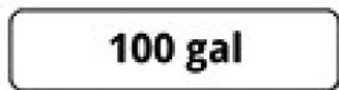

Preset Value

NOTE: Solution tank volume must be reset when tank is filled or solution is added for automatic agitation to operate correctly. See [Tank Fill Preset](#).

3. Select Close to return to previous page.



Close

Agitation Level Procedure

1. Select desired agitation level.



Agitation Level

NOTE: Turn off agitation when tank volume is below 100 gal (378.5 L) to reduce foaming.

2. Select Close to return to previous page.



Close

3. Press the Agitation Switch on the CommandARM™ to activate.

NOTE: Agitation level indicator on corner post display shows agitation level selected.

NOTE: Agitation can also be activated from the load station using the keypad. See your operator's manual for further information.



Agitation Switch

4. Press the Solution Pump Switch on the CommandARM™ to turn the solution pump(s) ON.

NOTE: Select either Standard/Low Flow (1 pump), or High Flow (2 pumps) through the Flow Rate Mode Page. The Solution Pump Switch on the CommandARM will then enable/disable the pumps selected.



Solution Pump Switch

Eductor Level

Eductor Level setting allows you to change the amount of suction produced in the eductor. The suction level must be correctly set to ensure proper loading of chemical while minimizing foaming.

Modify When:

- Foaming is a concern during loading.

- Product is not easily pulled into the solution tank.
- Product loading time is too fast or too slow.

Eductor Level allows you three (3) settings to create more or less suction in the eductor. Select from the following:

LOW - use to reduce chemical foaming during loading procedure.

MEDIUM - use for easy flowing chemicals.

HIGH - use for dry flowables and heavy or thick liquid chemicals.

Set Eductor Level Procedure

1. Select Eductor Level on the Tank System Main Page.



Eductor Level

2. Select desired eductor level. Value is automatically saved.



Eductor Level

3. Select Close to return to previous page.



Close



SECTION 10 – OPERATE LIQUID SYSTEM

Service and Operate Chemical Sprayers Safely

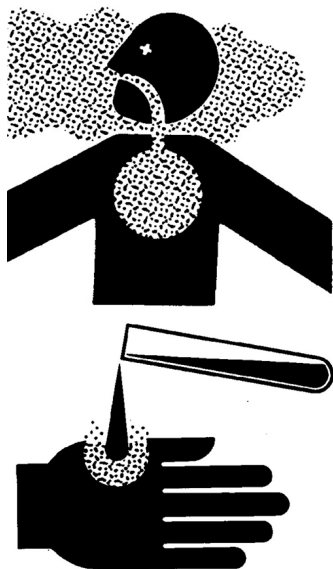

Chemicals used in agricultural sprayers can be harmful to your health or the environment if not used carefully. Always follow all label directions for effective, safe, and legal use of agricultural chemicals.

Reduce risk of exposure and injury:

- Wear appropriate personal protective equipment as recommended by the manufacturer, (See “Handle Agricultural Chemicals Safely” in the Safety section of this manual).
- Fill, flush, calibrate, and decontaminate sprayer in an area where runoff will not reach ponds, lakes or streams, livestock areas, gardens, or near other people.
- Keep children away from the chemicals, chemical solutions, and rinsates.
- If spray or chemical concentrate contacts skin, hands, or face, wash immediately with soap and water. If spray or chemical concentrate gets into eyes, flush immediately with water.
- If nozzle clogs or system malfunctions, stop engine and relieve spray pressure from system.

- Do not place nozzle tips or other components to the mouth to clear obstructions. Keep spare tips on hand for replacement.
- Minimize risk of spray drift.
 - Use large nozzle tips operated at lower pressures
 - Do not operate solution delivery system at pressures exceeding 345 kPa (3.5 bar) (50 psi).
 - Do not spray when winds exceed 16 km/h (10 mph)
 - Do not spray when wind is blowing towards a nearby sensitive crop, garden, or populated area.
- Properly dispose of unused chemicals, flushing solution, and empty chemical containers.
- Decontaminate equipment used in mixing, transferring, and applying chemicals after use.

Avoid Exposure to Chemicals



⚠ CAUTION

Exposure to chemicals, including pesticides, can cause injury or death. **DO NOT RELY ON CAB, CAB PRESSURE INDICATOR, OR CAB AIR FILTERS TO PROTECT AGAINST CHEMICAL EXPOSURE.**

To reduce risk of chemical exposure:

- Wear PERSONAL PROTECTIVE EQUIPMENT in accordance with chemical manufacturer's label
- Allow only trained, certified applicators to apply chemicals
- Always close the windows and doors during application
- Verify that John Deere-activated carbon filters, or appropriate substitutes, are installed at all times (see "Check and Replace Cab Air Filters" in the Cab and Air Conditioning section of your machine operator's manual)
- Keep chemicals out of the cab
- Clean or remove contaminated shoes or clothing before entering the cab
- Keep cab interior clean

Read and follow all instructions in:

- Manufacturer's label for each chemical applied
- U.S. Environmental Protection Agency (EPA) Worker Protection Standard for Agricultural Pesticides
- State or regional guidelines for worker safety and health
- Operator's Manual for this machine
- Numerous requirements must be met, including but not limited to EPA regulations
- Even while inside cab, always wear long sleeves, long pants, shoes, and socks when applying chemicals, including pesticides

- If necessary to leave cab when chemicals, including pesticides are present, always use personal protective equipment recommended by the chemical manufacturer
- Before reentering the cab, remove personal protective equipment used to handle chemicals, including pesticides, and store equipment in accordance with EPA guidelines to prevent contaminating cab

Prepare for Field Operation

⚠ CAUTION

Do not start the machine until you are sure that nobody is in the danger zone.

Verify that machine is properly prepared for field operation. Check the following items before operating:

- All maintenance has been performed.
- Correct nozzle tips are installed and set for the desired spray pattern and row spacing. (See Wet System section elsewhere in this manual for proper nozzle tip and row spacing selection).
- Display has been correctly programmed with the following:
 - Application Rates
 - Tank Volume
 - Minimum Spray Pressure
 - Spray Off Pressure
 - Number of Boom Sections
 - Nozzle Spacing
 - Spray Width
 - Check Flowmeter Calibration Number
 - Calibrate Pressure Sensor
 - Calibrate Wheel Speed Sensor
 - Calibrate Radar Sensor (if equipped)
- Perform boom air bleed procedure (see "Recommendations for Eliminating Air from Solution System" provided in the Wet System section for further information).

- Solution tank is filled, solution valves are correctly positioned, and agitation valve (if necessary) is open (see Wet System section for further information).
- Operator is familiar with all machine controls, their functions, and safe operations (see Operator's Station and Safety sections in your machine operator's manual for further information).
- Rinse water tank is filled with clean water (see "Rinse Tank Filling" in the Wet Systems section for further information).

4. Press the Solution Pump Switch (A) on the CommandARM™ to turn the solution pump(s) ON.

NOTE: Select either Standard/Low Flow (1 pump), or High Flow (2 pumps) through the Flow Rate Mode Page. The Solution Pump Switch on the CommandARM will then enable/disable the pumps selected.

Field Operation

CAUTION

Do not start the machine until you are sure that nobody is in the danger zone.

1. Unfold and position booms to desired position (see "Boom Unfold/Fold" in the 27.4 m (90 ft) Booms section for further information).
2. Set up the Gen 4 display for your particular application (see the Display Applications section in your machine operator's manual for proper setup procedure).
3. Verify that solution tank is loaded with solution.

NOTE: If no solution flow is detected, solution pump(s) will automatically shut off to prevent overheating and damage to seals.



A - Solution Pump Switch

SECTION 10 – OPERATE LIQUID SYSTEM



5. Select Rate Control Switch (A) programmed for desired application rate (1, 2, or 3) or the Manual Rate Switch (B) (see “Target Rate/Rx” in the Liquid System section for further information on modifying target rate presets).

NOTE: Rate selected is illuminated on the display.

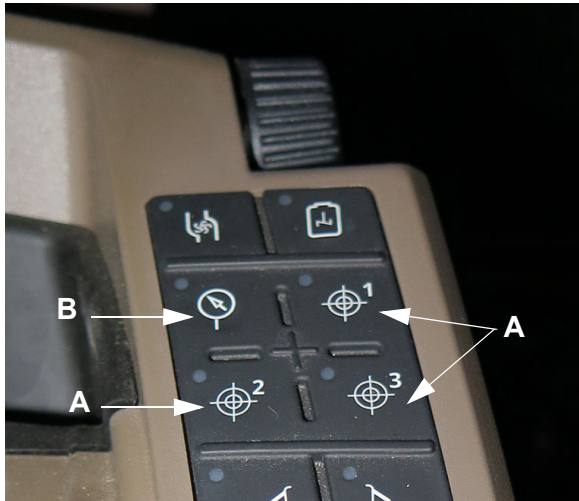

A - Rate Control Switch
B - Manual Rate Switch

7. Verify that desired boom sections are enabled (see “Boom Sections | Custom” in the Booms section for further information).

NOTE: The status of each boom section is indicated on the display.

6. Press the Multi-Function Lever (A) forward slowly to start forward motion.



A - Multi-Function Lever

8. Press the Spray System Master Switch (A) to start spray operation.

NOTE: Indicators (B and C) are illuminated when Spray System Master Switch is activated on the multi-function lever.

NOTE: Spray system shutdown is not immediate. Solution flow will continue for a few seconds after pressing the Spray System Master Switch. For best response time and coverage, turn off the Spray System Master Switch as you slow for the row end.



9. At the row end, press the Spray System Master Switch (A) to stop spraying. All other switches can remain in preset positions.

NOTE: Spray system startup is not immediate. To overcome delayed response, press the Spray System Master Switch while moving forward to start spraying just before solution is needed.



A - Spray System Master Switch

10. When aligned with the next row, press the Spray System Master Switch to resume spraying.



**A - Spray System Master Switch
B - Indicator
C - Indicator**

Operate Indexed Boom Sections (IBS)

Your machine is equipped with Indexed Boom Section (IBS) switching. This gives the operator another way to shut off boom spray sections in sequence without removing your hand from the multi-function lever. This function is useful when working with point rows and waterways.

NOTE: An audible alarm sounds when the IBS Switches are depressed.

SECTION 10 – OPERATE LIQUID SYSTEM



There are three (3) IBS Switches and operate as follows:

- Use the Left IBS Switch (A) to shut off individual boom sections sequentially, starting at the right-hand end of boom moving to left.
- Use the IBS Reset Switch (C) to restart all shutoff sections that are enabled.
- Use the Right IBS Switch (B) to shut off individual boom sections sequentially, starting at the left-hand end of boom moving to right.



A - IBS Switch (Left)
B - IBS Switch (Right)
C - IBS Reset Switch

box). Continue to press and release the Right IBS Switch to shut off remaining sections across the entire boom.

Once all sections have been shut off, press and release the Right IBS Switch (B) again to turn ON boom section (L3), then boom section (L2), and so on. If only a few sections have been turned off using the Right IBS Switch, you can turn them back on in sequence one at a time using the Left IBS Switch (A) or turn them all back on at once using IBS Reset Switch (C).

NOTE: The fence row nozzles shut off when the outermost boom sections are switched off. If a boom section is disabled using the display, it is ignored when turning boom sections on/off using the IBS function.

NOTE: Sections can be shut off from right to left using the IBS Reset Switch (C).

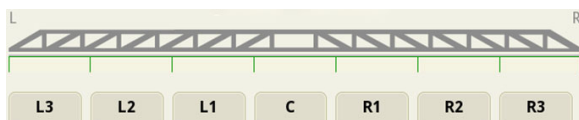

EXAMPLE: If you are coming upon an angled waterway and you would like to shut off sections in sequence from left to right, press and release the Right IBS Switch (B) once to shut off left-hand outer boom section (L3) (sections disabled by the IBS feature have a white background with an outlined



SECTION 11 – WET SYSTEM

Service and Operate Chemical Sprayers Safely

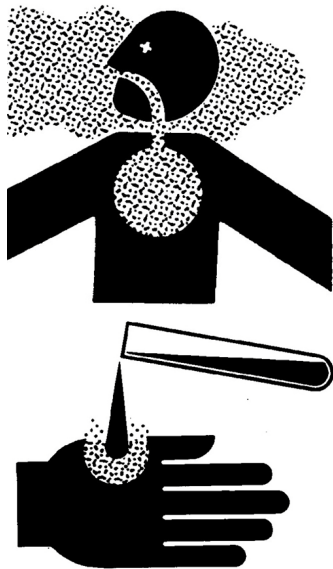

Chemicals used in agricultural sprayers can be harmful to your health or the environment if not used carefully. Always follow all label directions for effective, safe, and legal use of agricultural chemicals.

Reduce risk of exposure and injury:

- Wear appropriate personal protective equipment as recommended by the manufacturer, (See “Handle Agricultural Chemicals Safely” in the Safety section of this manual).
- Fill, flush, calibrate, and decontaminate sprayer in an area where runoff will not reach ponds, lakes or streams, livestock areas, gardens, or near other people.
- Keep children away from the chemicals, chemical solutions, and rinsates.
- If spray or chemical concentrate contacts skin, hands, or face, wash immediately with soap and water. If spray or chemical concentrate gets into eyes, flush immediately with water.
- If nozzle clogs or system malfunctions, stop engine and relieve spray pressure from system.

- Do not place nozzle tips or other components to the mouth to clear obstructions. Keep spare tips on hand for replacement.
- Minimize risk of spray drift.
 - Use large nozzle tips operated at lower pressures
 - Do not operate solution delivery system at pressures exceeding 345 kPa (3.5 bar) (50 psi).
 - Do not spray when winds exceed 16 km/h (10 mph)
 - Do not spray when wind is blowing towards a nearby sensitive crop, garden, or populated area.
- Properly dispose of unused chemicals, flushing solution, and empty chemical containers.
- Decontaminate equipment used in mixing, transferring, and applying chemicals after use.

Avoid Exposure to Chemicals



⚠ CAUTION

Exposure to chemicals, including pesticides, can cause injury or death. **DO NOT RELY ON CAB, CAB PRESSURE INDICATOR, OR CAB AIR FILTERS TO PROTECT AGAINST CHEMICAL EXPOSURE.**

To reduce risk of chemical exposure:

- Wear **PERSONAL PROTECTIVE EQUIPMENT** in accordance with chemical manufacturer's label
- Allow only trained, certified applicators to apply chemicals
- Always close the windows and doors during application
- Verify that John Deere-activated carbon filters, or appropriate substitutes, are installed at all times (see "Check and Replace Cab Air Filters" in the Cab and Air Conditioning section of your machine operator's manual)
- Keep chemicals out of the cab
- Clean or remove contaminated shoes or clothing before entering the cab
- Keep cab interior clean

Read and follow all instructions in:

- Manufacturer's label for each chemical applied
- U.S. Environmental Protection Agency (EPA) Worker Protection Standard for Agricultural Pesticides
- State or regional guidelines for worker safety and health
- Operator's Manual for this machine
- Numerous requirements must be met, including but not limited to EPA regulations
- Even while inside cab, always wear long sleeves, long pants, shoes, and socks when applying chemicals, including pesticides

- If necessary to leave cab when chemicals, including pesticides are present, always use personal protective equipment recommended by the chemical manufacturer
- Before reentering the cab, remove personal protective equipment used to handle chemicals, including pesticides, and store equipment in accordance with EPA guidelines to prevent contaminating cab

**Avoid Contact with
Chemicals, Including
Pesticides**



⚠ CAUTION

This enclosed cab does not protect against chemical exposure, including exposure to pesticides.

1. When operating in an environment where harmful chemicals are present, wear a long-sleeved shirt, long-legged trousers, shoes, and socks.

2. If chemical label requires respiratory protection, wear an appropriate respirator in the cab.
3. Wear personal protective equipment (PPE) as required by the chemical label when leaving the enclosed cab:
 - into a treated area,
 - to work with contaminated application equipment, such as nozzles, which must be cleaned, changed, or redirected,
4. Before re-entering the cab, remove personal protective equipment (PPE) and store either outside the cab in a closed box or some other type of sealed container, or inside the cab in a pesticide-resistant container.
5. Clean or remove contaminated shoes or clothing before entering the cab.

Solution System Schematic

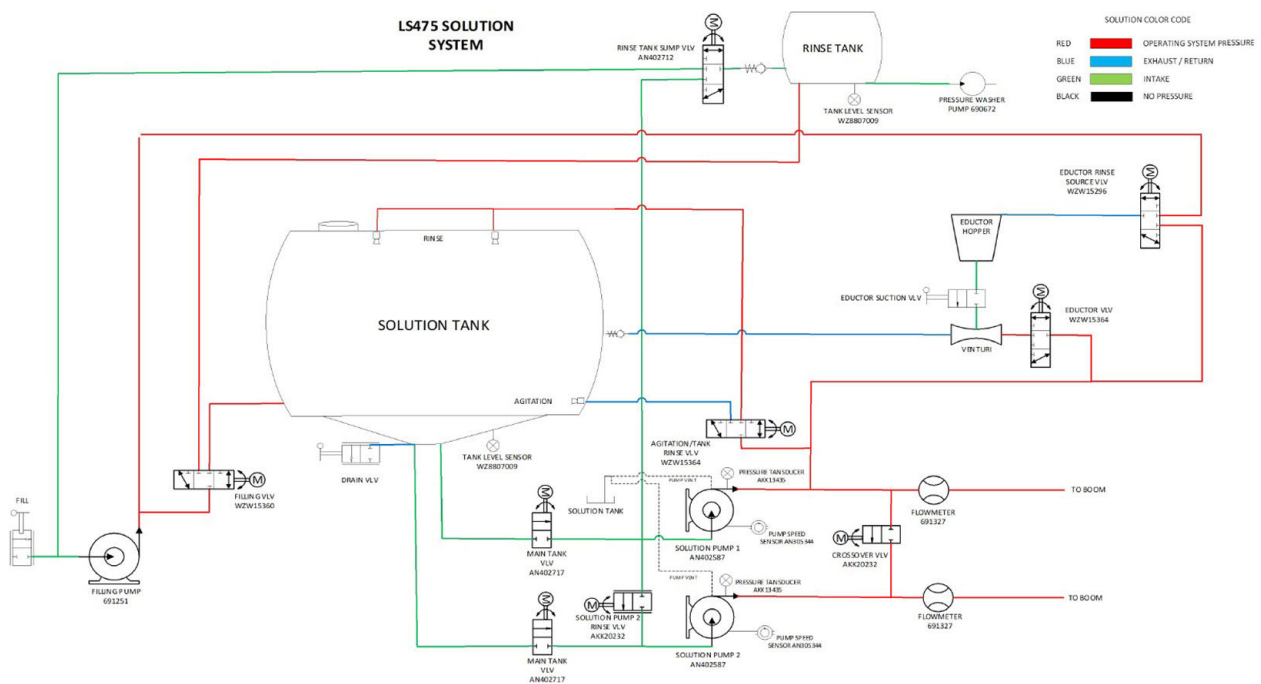

Solution System - Overview

Solution System Components

- (A) - Solution Tank
- (B) - Rinse Tank
- (C) - Rinse Tank Sump Valve
- (D) - Eductor Valve
- (E) - Eductor Rinse Source Valve
- (F) - Tank Rinse/Agitation Valve
- (G) - Crossover Valve
- (H) - Flowmeter (2)
- (I) - Solution Pump (2)
- (J) - Electric Standard Flow Valve
- (K) - Electric High Flow Valve
- (L) - Orifice Valve
- (M) - Solution Strainer (2)

**SECTION 11 –
WET SYSTEM**

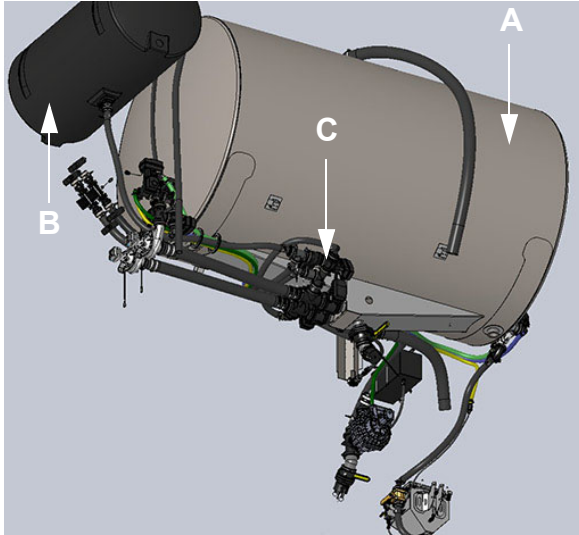

A - Solution Tank
B - Rinse Tank
C - Rinse Tank Sump Valve

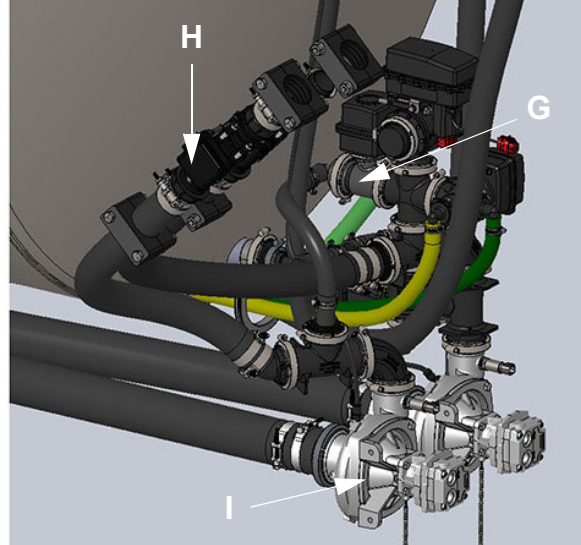

G - Crossover Valve
H - Flowmeter (2)
I - Solution Pump (2)

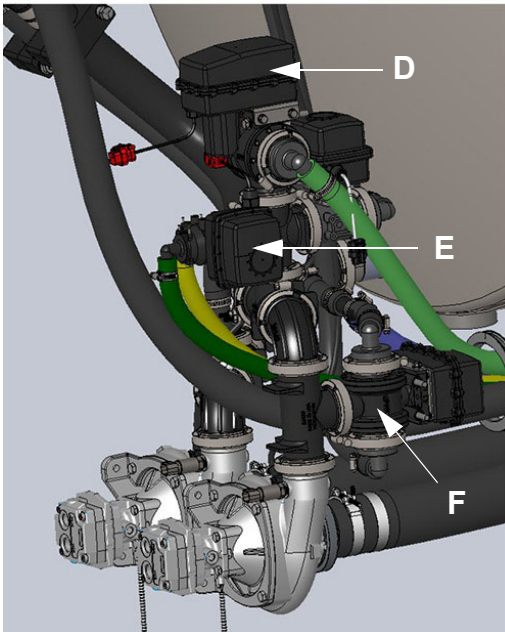

D - Eductor Valve
E - Eductor Rinse Source Valve
F - Tank Rinse/Agitation Valve

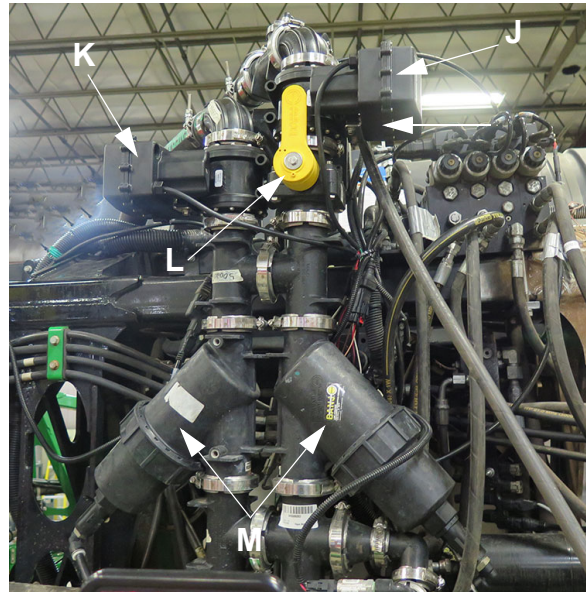

J - Electric Standard Flow Valve (standard spray rate application)
K - Electric High Flow Valve (high spray rate application)
L - Orifice Valve (low spray rate application)
M - Solution Strainers (2), 50-Mesh

Solution Command System Panel

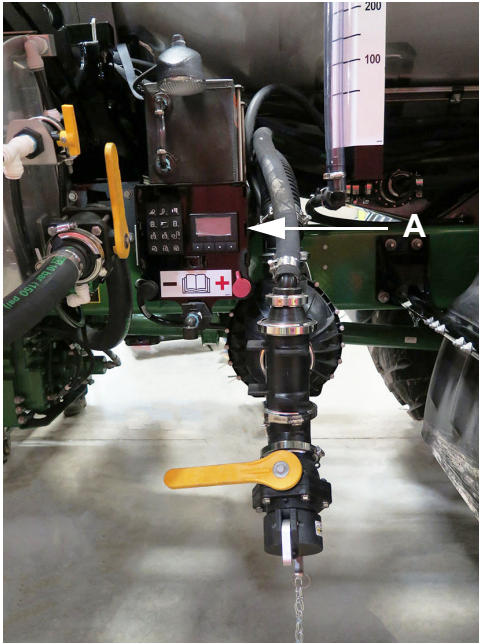

A - Solution Command System Panel

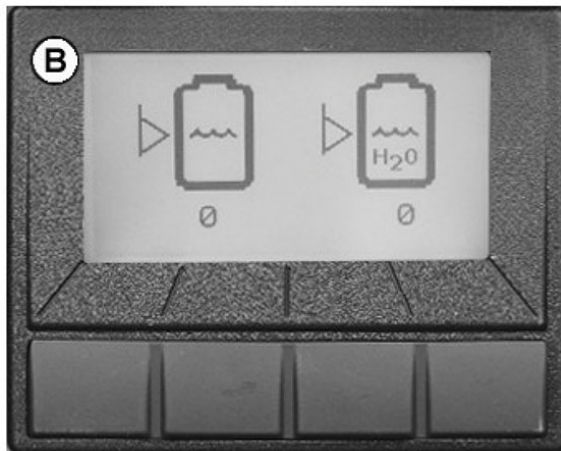

B - Solution Command Micro Display

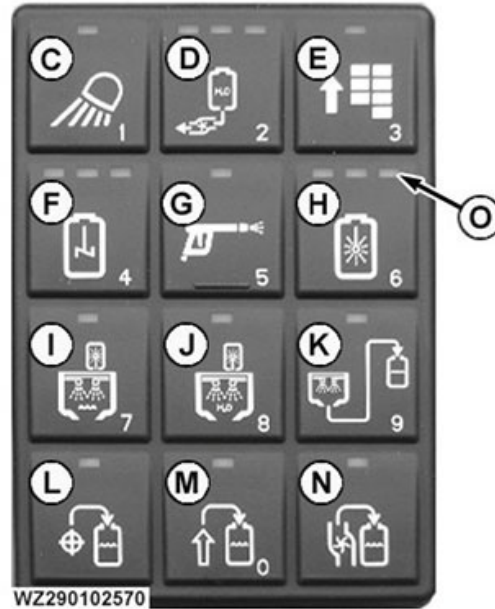

- C - Fill Station Light Button
- D - Rinse Tank Button - N/A
- E - Menu Button/Rinse Tank Fill Button
- F - Agitation Button
- G - Pressure Washer Button
- H - Rinse Button (system rinse or boom rinse)
- I - Eductor Rinse Button (using solution - filling eductor from solution tank)
- J - Eductor Rinse Button (using rinse water - filling eductor from rinse tank)
- K - Eductor Venturi Button (sending liquid from eductor to solution tank)
- L - Auto Fill Button (target fill of solution tank)
- M - Manual Fill Button (manual fill of solution tank)
- N - Select Filling Pump (pull-on fill with filling pump to nominal tank volume - 2000 gal/7570 L)
- O - Button Indicator

NOTE: Return all buttons to the OFF position (indicated with an LED indicator) after use. A warning message "Remote Load Active" appears on the Gen 4 display showing Solution Command System Panel is not in the OFF position.

The Solution Command Micro Display (B) home screen shows the solution tank content (left) and the rinse water tank content (right) in liters. Keypad functions are as follows:

- C - Fill Station Light Button.
- D - Rinse Tank Button - N/A
- E - Menu Button - Nozzle Check and Automatic Rinse Tank Filling.

SECTION 11 – WET SYSTEM



- **F** - Agitation Button - Turns agitation on-off.

NOTE: Agitation off volume is set from the display in the cab.

- **G** - Pressure Washer Button.
- **H** - Rinse Button - System Rinse or Boom Rinse.

NOTE: System Rinse performs rinse cycle at the volume setting that is set on the display in the cab. The rinse system program steps through the solution system for a complete rinse. The operator has to spray out the residual liquid at the end of the program. The program can be canceled or stepped forward on the micro display buttons. Set boom rinse in the display in the cab for the use of the Rinse Button function.

- **I** - Eductor Rinse Button - Activate flushing nozzles.

NOTE: Water is from the solution tank via the solution pump.

- **J** - Eductor Rinse Button - Activate flushing nozzles.

NOTE: Water is used from the rinse tank (unless filling while educting). Active Pause stops the filling process and uses the filling connection water for the eductor flushing nozzles.

- **K** - Eductor Venturi Button - Transfers eductor contents to the solution tank.
- **L** - Auto Fill Button - Enter required volume via numerics on keypad and confirm volume.

NOTE: Auto fill is used for filling with the filling pump. The symbol on the right shows the target value entered on the previous screen. The symbol on the right shows the current solution tank content. The content counts up as the sprayer is filled. Press the Cancel Button to stop the filling process at any time.

- **M** - Manual Fill Button - Via 3" (7.6 cm) filling connection.

- **N** - Select Filling Pump Button (N) - On/off control for the filling pump. Indicators (O) display the status (on-off) of the function controlled by that button. Indicator light ON indicates that the function is ON. Indicators can also display at what setting the function is operating. Buttons (C-K and M) can be used to enter values 0-9 on the micro display when required.

NOTE: If the Select Filling Pump Button (N) is left on, it will stop when tank level reaches nominal 2000 gal (7570 L) full mark (per the level sensor).

Solution Tank

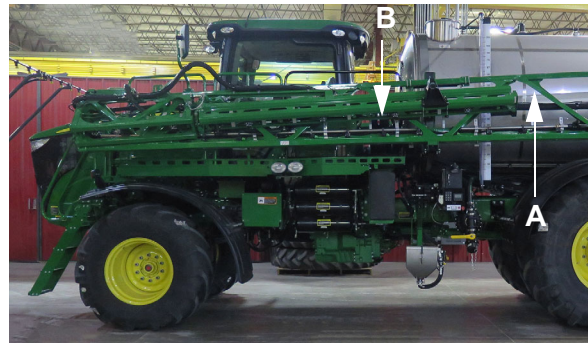

A - Solution Tank
B - Filling Platform

Your machine is fitted with a stainless steel solution tank (C) with a nominal tank volume of 7570 L (2000 gal). The maximum tank volume is at least 5% larger than the nominal volume of the solution tank. This extra volume is required for possible foaming. Allow for foaming when filling the tank - that is, do not fill the tank with more than the nominal volume.

The tank is mounted on the frame and is enclosed in supporting brackets at the back and front. The solution tank fill opening can be accessed via the filling platform (B).

NOTE: Overall dead volume = 106.7 L (28.2 gal).

Solution Tank Fill Opening

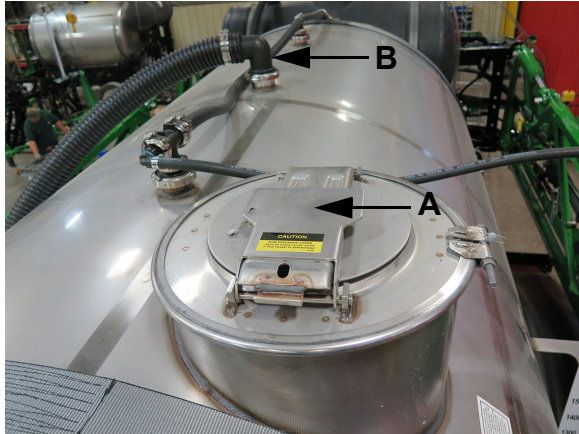

A - Tank Lid Handle
B - Tank Vent

The raised Solution Tank Fill Opening has a diameter of 40 cm (15 in) and has a hinged tank lid. The lid can be opened by pulling UP on the Tank Lid Handle (A). The lid is closed by pressing DOWN on the Tank Lid Handle (A). An additional Tank Vent (B) is fitted for sufficient ventilation when filling the tank at high capacity.

Liquid Level Indicator (Solution Tank)

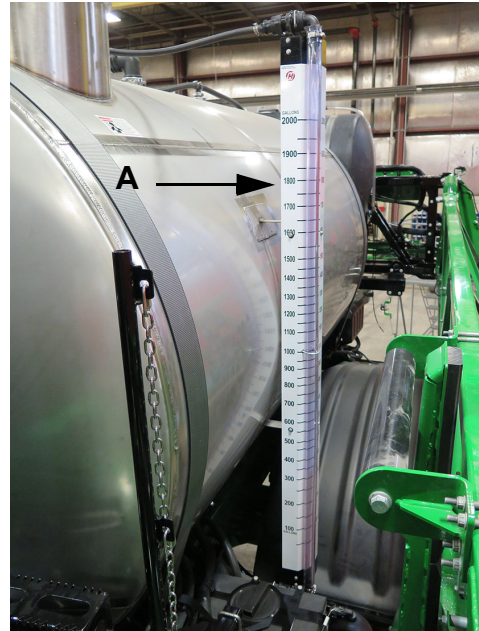

A - Liquid Level Indicator

Solution tank contents can be read on the Liquid Level Indicator (A) located on the front left-hand side of the solution tank. The indicator is graduated in 50-gallon intervals.

Solution Tank Level Pressure Sensor

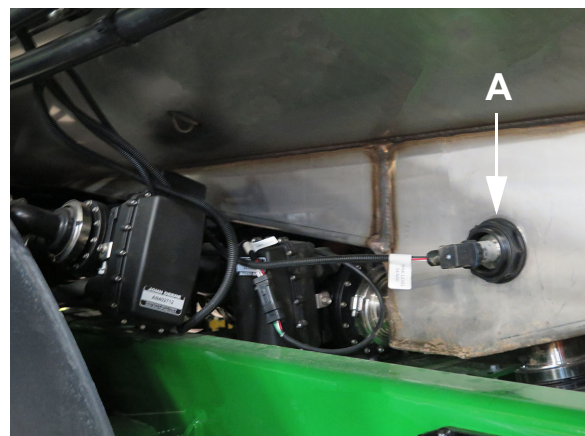

A - Solution Tank Level Pressure Sensor

The Solution Tank Level Pressure Sensor (A) fitted in the bottom of the solution tank makes it possible to read the actual tank volume accurately on the Gen 4 display. The

pressure sensor is a very sensitive electronic component and must not be struck or cleaned with high pressure, as the sensor could become damaged.

Agitation

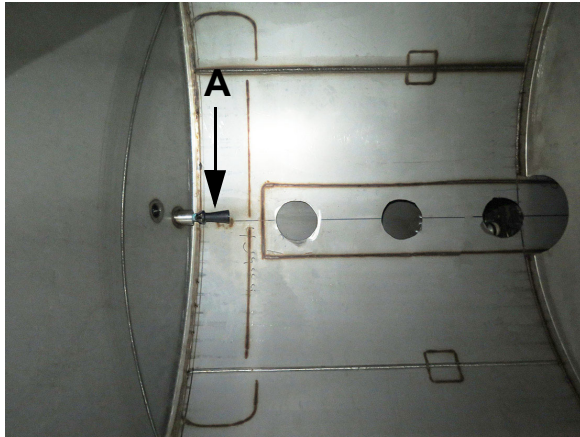

A - Agitation Nozzle (2)

Effective agitation is very important in gaining a homogenous spraying liquid, particularly for suspensions and emulsions. Inadequate agitation can result in crop damage, inadequate effect of the chemical, and blockage of the machine.

The solution tank is equipped with two (2) Agitation Nozzles (A) centered horizontally - one at the front of tank, and one at the back of tank. Agitation flow is tapped from the pump outlet. There is no primary pressure regulator. The pump provides a high volume of flow through the large nozzles to provide powerful tank agitation.

If the solution tank becomes empty and the liquid level drops under the nozzles, the nozzles can be automatically deactivated so that the tank can be sprayed empty and foaming is limited. Agitation performance can be controlled through the Gen4 display Tank System Main Page. For further information on agitation control, see “Agitation” in the Tank System section in this manual.

Chemical Educator

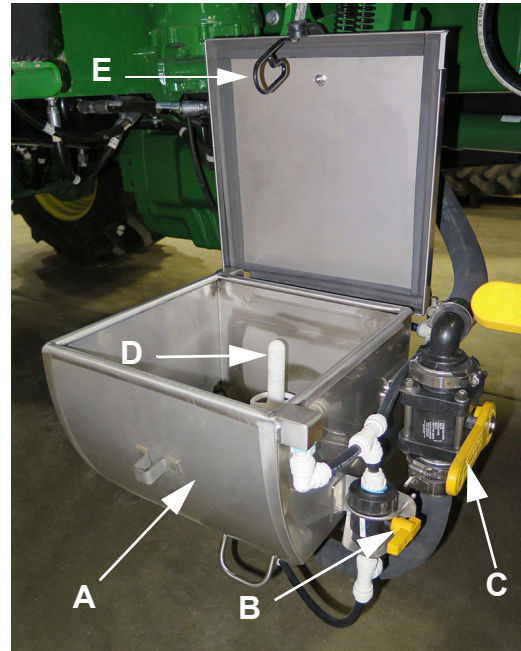

- (A) - Chemical Educator Hopper
- (B) - Educator Rinse Valve
- (C) - Educator Suction (Sump) Valve
- (D) - Rinse Head
- (E) - Locking Device
- (F) - Educator Rinse Button (solution pump)
- (G) - Educator Rinse Button (fill pump - rinse water)
- (H) - Educator Venturi Button

**⚠ CAUTION**

Keep fill opening closed while the eductor is in use to avoid splashing as liquid enters the solution tank.

IMPORTANT: Clean and rinse the chemical eductor after every use.

The chemical eductor is located on the center left-hand side of machine and makes it possible to work from ground level. The system comprises an eductor hopper with cover, with a capacity of approximately 30 L (7.9 gal). The eductor contains rinse nozzles, a rinse head with tenter frame for flexible containers, and a sieve plate for preparing powdered (solid) chemicals into solution.

IMPORTANT: Before exiting the cab to use the chemical eductor, lower engine rpm with the engine speed control lever on the CommandARM™ to slow idle.

The eductor is set to the working position by pushing the eductor slightly forward and unlocking the transport device (press catch down) while simultaneously pulling out the eductor. The eductor must be folded back to the transport position before commencing spraying work in order to avoid crop damage and damage to the eductor.

The eductor suction valve allows the contents of the eductor to enter the solution tank via the venturi. The arrow on the valve handle indicates which direction the solution is being drawn from. In the open position, the valve handle will be parallel to the valve body. In the closed position, the valve handle is perpendicular to the valve body.

To supply rinse water to the flushing nozzles, the rinse water tank selector button and the eductor rinse button on the solution command system panel has to be set (see “Solution Command System Panel” in this section). Alternatively, use the eductor rinse button while filling. Open rinse nozzle shutoff

valve in order to let water into the eductor via the flushing nozzles. The flushing nozzles also rinse the eductor walls.

The venturi is fitted in the raised filling opening of the solution tank to suck up the dissolved chemicals from the eductor and convey them into the tank via the basket strainer.

The rinse head has a shutoff valve in the supply line, which is operated by pressing down the metal ring around the rinsing head. The valve will automatically close when this ring is released. The rinsing system can be simply used by placing the container over the rinsing head and onto the metal ring. Hold the container firmly and press down to open the valve so that the rinsing head flushes the inside of the container clean. This takes approximately 30 seconds. Raise the container and the rinse water will automatically stop.

Filling/Draining the Chemical Eductor

See “Rinse Tank Draining” in this section for further information.

Chemical Eductor - Rinsing Empty Containers



*NOTE: For bags, place the tenter over the rinse head. Place the bag over the tenter, ensuring that the rinsing head is completely closed and press **DOWN** on the tenter to rinse.*

Rinsing must be done with clean water. Clean water is obtained externally via the filling hose using the select Rinse Water Tank and Eductor Rinse Button/Filling Active Pause (B). To use clean water from the rinse water tank, perform a rinse tank transfer (see “Rinse System - Rinse Tank Transfer” in the Rinse Systems section elsewhere in this manual.

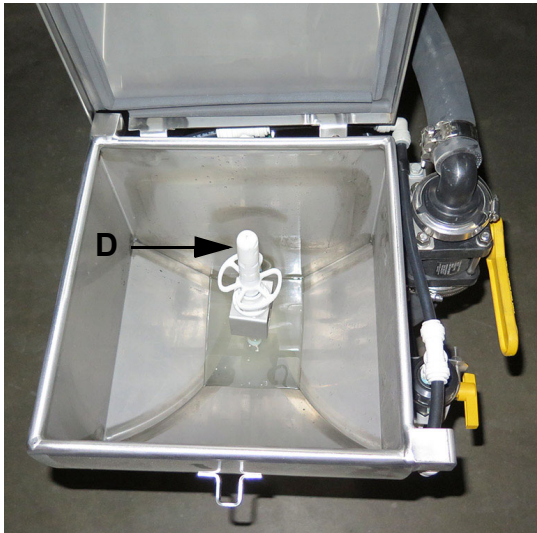

- A - Eductor Rinse Button (Activate Flushing Nozzles)
- B - Eductor Rinse Button/Filling Active Pause (Activate Flushing Nozzles)
- C - Eductor Venturi Button
- D - Eductor Container Rinse Head

To Rinse Container

1. Press the Eductor Rinse Button (A) on the solution command system keypad.
2. Place the container opening face-down over the Rinse Head (D) and push **DOWN** until clean water flows.

NOTE: Rotate the container while rinsing. Rinse for at least 30 seconds at a rinsing pressure between 3-5 bar (43-72 psi).

Chemical Educator Rinse

To Rinse the Educator Hopper

1. Press Educator Rinse Button (A) on the solution command system keypad with the water source from Educator Tank (B).

NOTE: An LED indicator on the button will illuminate when active.



A - Educator Rinse Button
B - Educator Tank (in working position)
C - Rinse Valve
D - Sump Valve

2. Rotate the Educator Rinse Valve (C) in the OPEN position and allow educator hopper to rinse.

3. When rinsing is complete, rotate the Educator Rinse Valve in the CLOSED position.
4. Rotate the Educator Sump Valve (D) in the OPEN position and pull rinse water into the solution tank.
5. When finished, press the Educator Rinse Button (A) in the OFF position.

Pressure and Flow Measurement

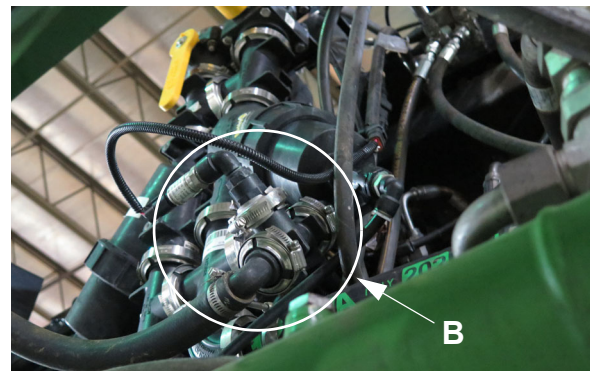
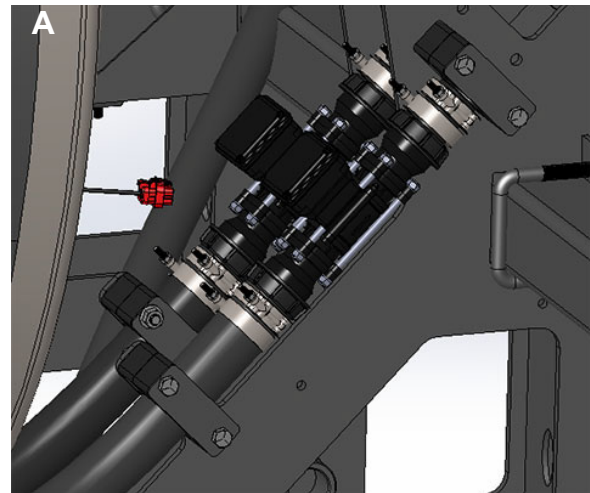

A - Flowmeter (2)
B - Boom Pressure Sensor
C - Solution Pump Pressure Sensor (2)

Spray pressure is shown on the Gen 4 display. The Liquid System has been fitted with two (2) Flowmeters (A) and three (3) Pressure Sensors - one on the boom (B) and one on each of the solution pumps (C). The spray rate control unit (SRC) uses these inputs to monitor and control the system to maintain target application rate. Refer to the Liquid System section in this manual for further information.

NOTE: The Flowmeters are equipped with an identification tag, which contain the part number, serial number, and the calibration value.

NOTE: The calibration value is used on the Gen 4 display.

Electric Boom Section Valves

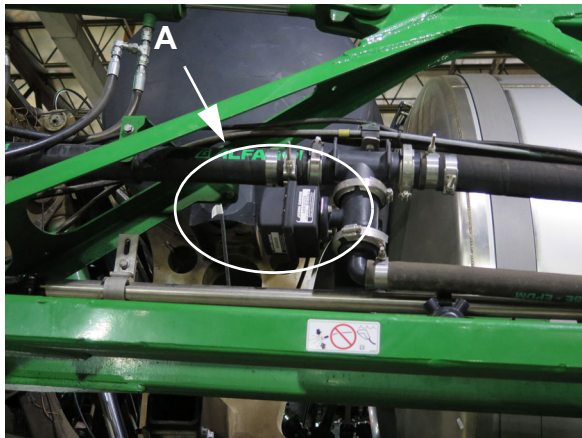

A - Electric Boom Section Valve

Fluid is transported to the left and right-hand spray boom segments from the pressure filter. Using the Boom Section Valves (A), seven (7) sections can be operated. The Gen 4 sprayer control system can control up to 15 boom sections (L7-L6-L5-L4-L3-L2-L1-C-R1-R2-R3-R4-R5-R6-R7). The sections are shut on-off by electrically operated two-way valves integrated in the spray boom.

Hand Wash Tank

CAUTION

Fill hand wash tank with clean water only. This water is intended for washing and not for drinking.

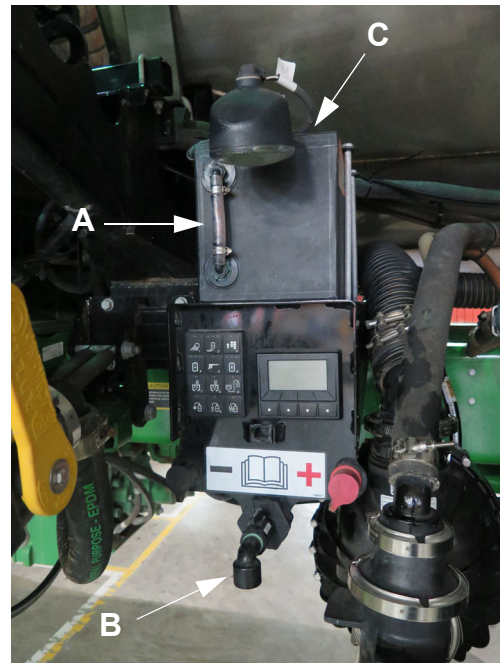

**A - Hand Wash Tank
B - Drain Outlet (with on/off valve)
C - Fill Opening (with cap)**

Your machine is equipped with a Hand Wash Tank (A) with Drain Outlet (B) located on the left-hand side of machine for personal hygiene and protection. Fill with clean water only from the main water supply through the top Fill Opening (C).

Rinse Water Tank

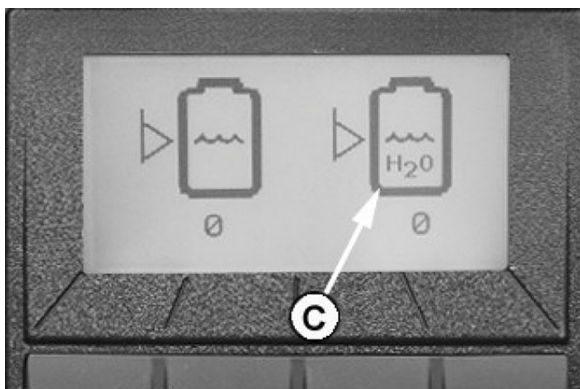
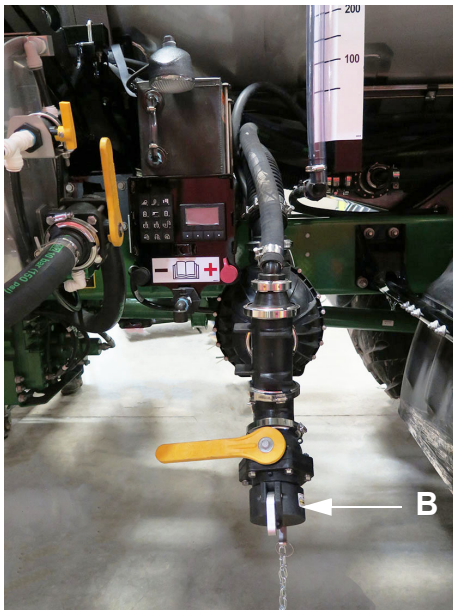
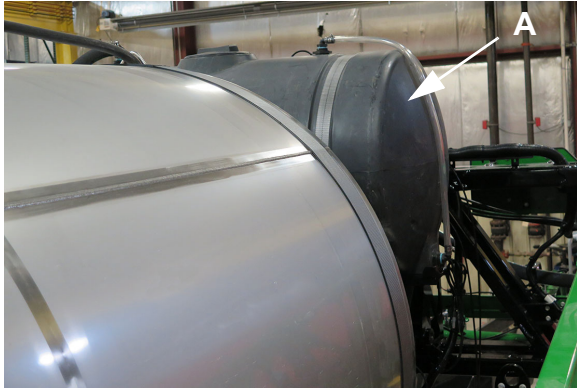

A - Rinse Water Tank
B - Rinse Water Tank Fill Connection
C - Rinse Water Tank Level Indicator (micro display)

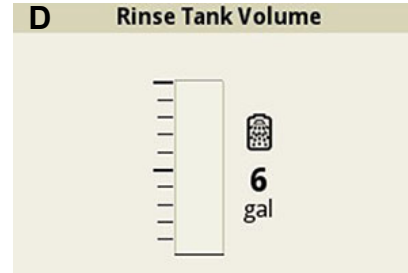

D - Rinse Water Tank Level Indicator (Gen 4 display)

⚠ CAUTION

Fill the rinse water tank with clean water only.

⚠ CAUTION

Do not exceed tire weight load ratings printed on the sidewall of tires. Verify maximum transport weight from the sidewall of tire before loading and do not exceed that weight.

Refer to the Wheels and Tires section for proper tire inflation recommendations for your machine configuration, and to the Safety Signs section in your machine operator's manual for guidelines on transporting machine.

The Rinse Water Tank (A) is located on the rear of the machine. It provides a 757 L (200 gal) supply of clean rinse water for in-field cleaning. The tank is filled via the Rinse Water Tank Fill Connection (B) or the fill opening on top of the tank. The Rinse Water Tank is also fitted with an overflow hose.

NOTE: To avoid contamination, fill the Rinse Water Tank from the main water supply.

The Tank Level Indicator (C) is located on the micro display on the right-hand side of machine. The micro display default screen shows the solution tank content (left) and the rinse water tank content (right) in liters. The Rinse Water Tank has a digital level indicator (the same sensor is used for the solution tank). An additional Rinse Water Tank Level Indicator (D) is displayed on the Gen 4 display Rinse System and Tank System Main Pages.

Solution Tank Rinse Nozzles

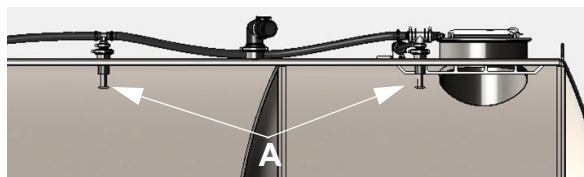

A - Rinse Nozzles (2)

Your solution tank is fitted with two (2) internal Solution Tank Rinse Nozzles to aid in cleaning the tank. The nozzles use clean water from the rinse tank to rinse the solution tank.

Solution Tank Filling

⚠ CAUTION

Chemicals may be hazardous to personal health. Carefully read the directions printed on the chemical label before handling.

⚠ CAUTION

Filling valve of solution tank fill connection can contain chemical solution, which may be hazardous to personal health. Care should be used when removing the fill connection cap.

⚠ CAUTION

Observe tank level carefully to avoid overfilling, and the possibility of tank contents (with chemicals) running out through the solution tank overflow.

IMPORTANT: Only add chemical just prior to field use and not before. Follow the chemical manufacturer's instructions for mixing the spray solution for desired application rate and effect.

IMPORTANT: Maximum fill pump circuit pressure is 6.9 kPa (.07 bar) (50 psi). Exceeding this pressure will cause the fill pump case to crack.

NOTE: Solution Tank capacity = 2,000 gal (7570 L).

1. Ensure the Shutoff Valve (A) is in the CLOSED (clockwise) position.
2. Remove Fill Cap (B).
3. Attach 3" Fill Hose (C) and clamp to secure.

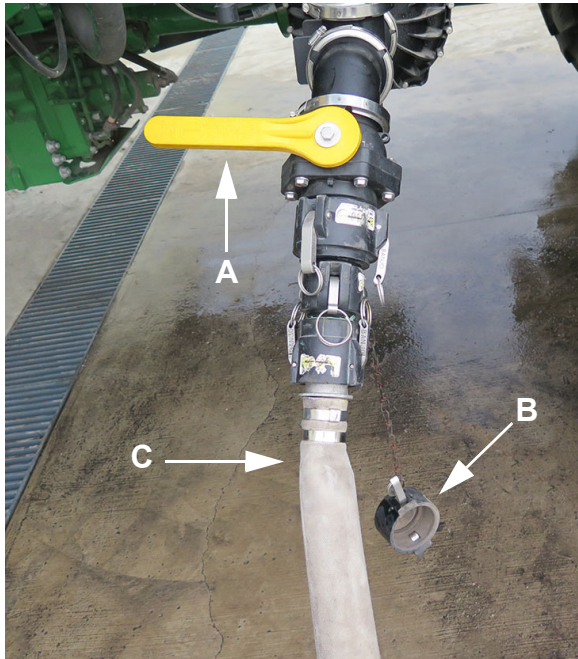

A - Shutoff Valve
B - Fill Cap
C - 3" Fill Hose

4. Start the machine.

NOTE: Current solution tank level (D) will be displayed on the exterior Solution Command Micro Display.

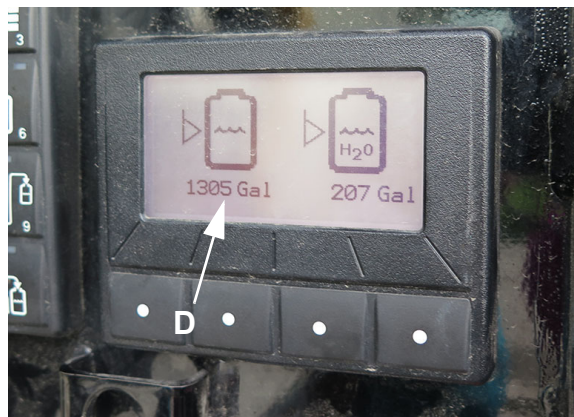

D - Solution Tank Level

5. Fill solution tank via **Target Fill** or **Manual Fill**.

Target Fill

- Enter target fill preset through the Gen 4 display (see Target Fill in the Tank System section for further information).

NOTE: Alternatively, you may use the Solution Command Keypad at the fill station to enter a target value. Press the Auto Fill Button (E) to go into number mode. The value entered is visible on the Micro Display. Press the Enter Button on the display to accept and start filling.

- Rotate the Shutoff Valve (A) in the OPEN (counter-clockwise) position.
- Press the Auto Fill Button (E) on the Solution Command Keypad and allow tank to fill.

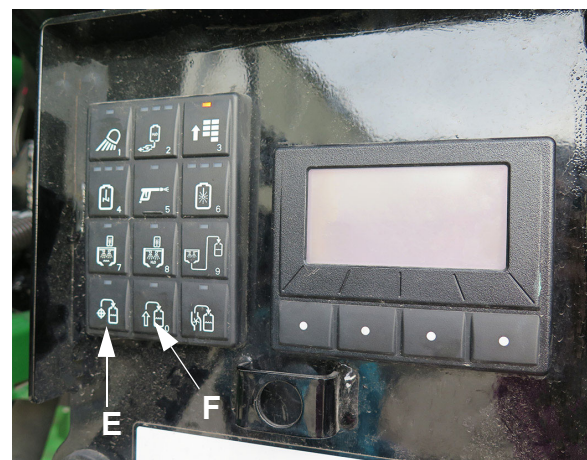

E - Auto Fill Button
F - Manual Fill Button

Manual Fill

- Rotate the Shutoff Valve (A) in the OPEN (counter-clockwise) position.
 - Press the Manual Fill Button (F) on the Solution Command Keypad to open the fill valve.
 - Fill solution tank by pushing on with external pump and allow tank to fill.
6. **When finished filling solution tank,** rotate the shutoff valve (A) in the CLOSED (clockwise) position, disconnect fill hose (C), and reinstall fill cap (B).

Solution Tank Draining

⚠ CAUTION

DO NOT drain chemical onto the ground. Drain into a suitable container or approved drain. Drain solution in an area where people, animals, vegetation, and water supply cannot be contaminated.

⚠ CAUTION

Wear personal protective equipment (PPE) in accordance with chemical manufacturer's label.

⚠ CAUTION

Ensure the vehicle is parked, level, and the engine is turned OFF before entering under the vehicle.

IMPORTANT: Spray out or transfer contents prior to draining the solution tank.

1. Place a suitable container or bucket under the Drain Outlet (A) on right-hand side of machine.
2. Ensure the Solution Tank Drain Valve (B) is in the CLOSED position.

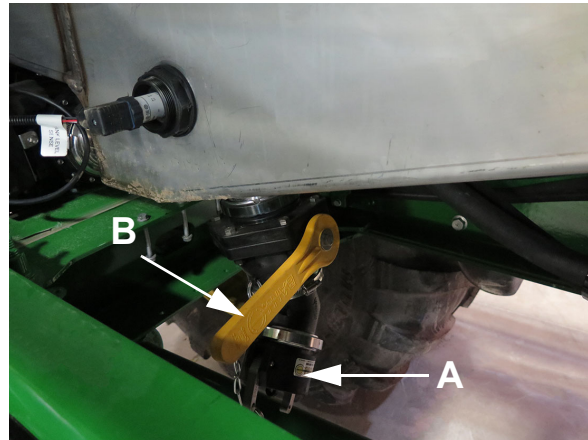

A - Drain Outlet
B - Solution Tank Drain Valve

3. Remove cap from end of drain outlet.
4. Rotate the Solution Tank Drain Valve (B) in the OPEN position to drain solution tank.
5. When finished, rotate the Solution Tank Drain Valve in the CLOSED position and reinstall cap to end of drain outlet.

Rinse Tank Filling

⚠ CAUTION

Fill the rinse tank with clean water only.

NOTE: Rinse Tank capacity = 200 gal (757 L).

1. Ensure the Shutoff Valve (A) is in the CLOSED (clockwise) position.
2. Remove Fill Cap (B).
3. Attach 3" Fill Hose (C) and clamp to secure.

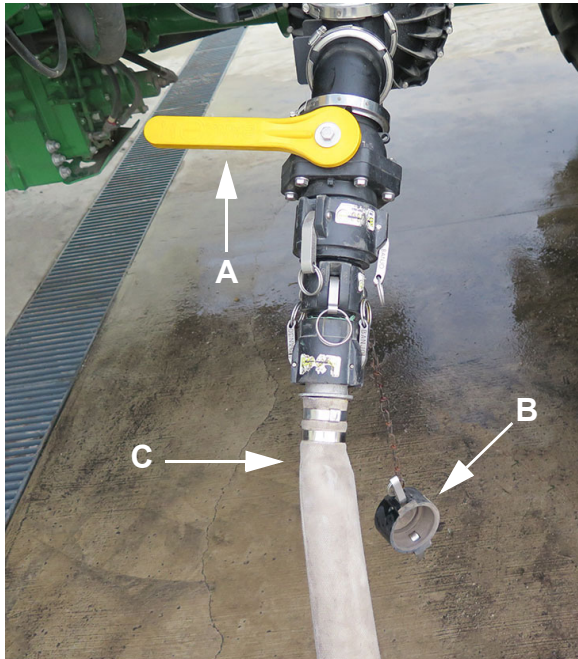

A - Shutoff Valve
B - Fill Cap
C - 3" Fill Hose

4. Start the machine.

NOTE: Current rinse tank level (D) will be displayed on the exterior Solution Command Micro Display.

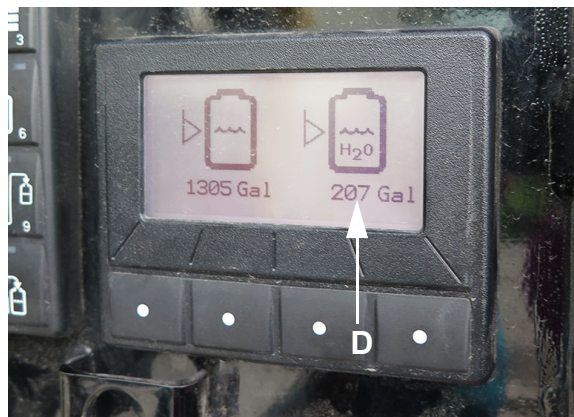

D - Rinse Tank Level

5. Fill rinse tank in **Automatic Fill** or **Manual Fill** mode.

Automatic Fill Mode

- Rotate the Shutoff Valve (A) in the OPEN (counter-clockwise) position.
- Press the Rinse Tank Fill Button (E) on the Solution Command Keypad.

- Press the Auto Fill Button (F) on the Solution Command Micro Display and allow tank to fill.

NOTE: Press the Enter Button (I) to select action, or the Cancel Button (H) to cancel action.

NOTE: Auto Fill uses the on-board fill pump to fill the rinse tank and will shut off when tank level reaches 200 gal (757 L).



E - Rinse Tank Fill Button
F - Auto Fill Button
G - Manual Rinse Button
H - Cancel Button
I - Enter Button

Manual Fill Mode

NOTE: Manual Fill opens the same valve as Auto Fill to give a path to the rinse tank, but requires an external pump to push clean water to it.

- Rotate the Shutoff Valve (A) in the OPEN (counter-clockwise) position.
- Press the Manual Rinse Button (G) on the Solution Command Keypad and allow tank to fill.

6. **When finished filling rinse tank**, rotate the shutoff valve (A) in the CLOSED (clockwise) position, disconnect fill hose (C), and reinstall fill cap (B).

NOTE: Alternatively, the rinse tank may be filled via the fill opening on top of the tank.

Rinse Tank Draining

To Fill Eductor (from rinse tank)

1. With the engine running, lower the Eductor.
2. Rotate BOTH Eductor Valves (A and B) in the OPEN (down) position.

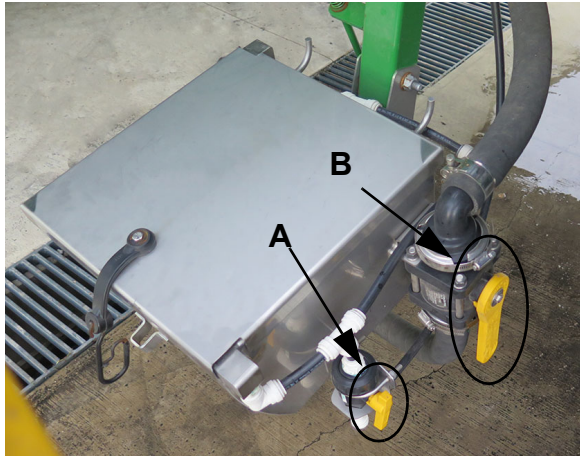

A - Eductor Valve
B - Eductor Valve

3. Press the Eductor Rinse Button (C) on the Solution Command Keypad and fill eductor from rinse tank.



C - Eductor Rinse Button (filling from rinse tank)
D - Eductor Rinse Button (filling from solution tank)

4. **When finished filling**, press the Eductor Rinse Button (C) again.

To Fill Eductor (from solution tank)

5. Perform Steps 1-4 of the “Draining Rinse Tank” procedure.

6. Press the Eductor Rinse Button (D) on the Solution Command Keypad and fill eductor from solution tank.

To Drain Eductor (to solution tank)

- Rotate the large Eductor Valve (B) in the OPEN (down) position.
- Press the Eductor Venturi Button (E) on the Solution Command Keypad and allow the eductor to drain into the solution tank.



E - Eductor Venturi Button

Solution Pumps

The Solution Pumps are automatically started and stopped with the keypad buttons on the solution command system panel without having to return to the cab to operate the pump switch on the armrest.

IMPORTANT: The solution system maximum operating pressure is 10 bar (145 psi).



A - Solution Pumps

Solution Pump Recommendations

IMPORTANT: Chemicals and chemical residue left in the solution pumps for an extended period can be damaging to pump components. Rinse pump interior with clean rinse water daily and do not let chemical solution remain in the pump overnight.

To ensure longevity of the solution pumps, follow these recommendations:

- **Do not engage centrifugal pump(s) dry.** Operating the pump(s) dry will significantly reduce pump life.
- **Winterize pump(s) properly.** Proper winterization of the solution system can increase solution pump life. See the Storage section in your machine operator's manual to clean, winterize, and store the machine for an extended period of time.

Agitation of Solution Tank Contents

To enable agitation of the solution tank contents, press the Agitation Button (A) on the solution command system keypad.

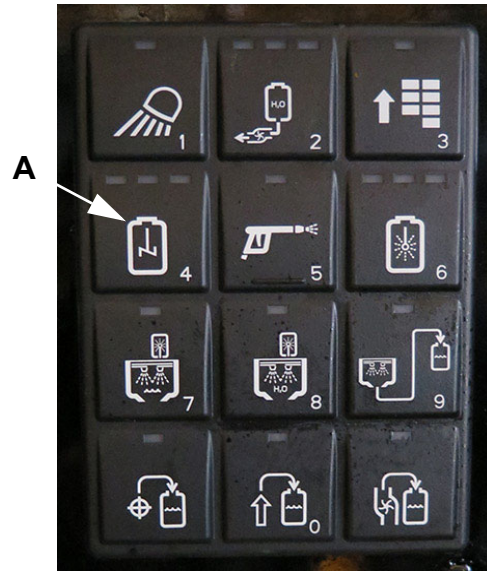

A - Agitation Button

There are three (3) LED indicators on the top of the button. Each press of the Agitation Button increases the percentage of agitation.

- When the first LED indicator is illuminated, agitation is running at 30%.
- When two (2) LED indicators are illuminated, agitation is running at 60%.
- When three (3) LED indicators are illuminated, agitation is running at 100%.

NOTE: Agitation is also enabled via the Solution Pump/Agitation Switch on the CommandARM™.

Rinse System - System Rinse/Boom Rinse

IMPORTANT: For System Rinse and Boom Rinse, ensure that all spray sections are enabled. The rinse systems need a safe area to spray out residual liquid with an unfolded boom.

SECTION 11 – WET SYSTEM



System Rinse

NOTE: After solution tank has been drained, complete the following steps when using System Rinse to rinse entire solution system or only the boom assembly.

NOTE: Using the Rinse Button (A) performs one rinse cycle for the System Rinse. The setting currently shown on the display for the Rinse Cycle Volume (Low, Medium, or High) is used for the rinse cycle.

1. Press the Rinse Button (A) on the solution command system keypad.



A - Rinse Button

2. Press Select System Rinse. The rinse procedure begins automatically and rinses the following:
 - Eductor Venturi Line (C)
 - Agitation (G)
 - Solution Tank (H)
 - Spray Out Residual Liquid (I) (open spray master valve in the cab)

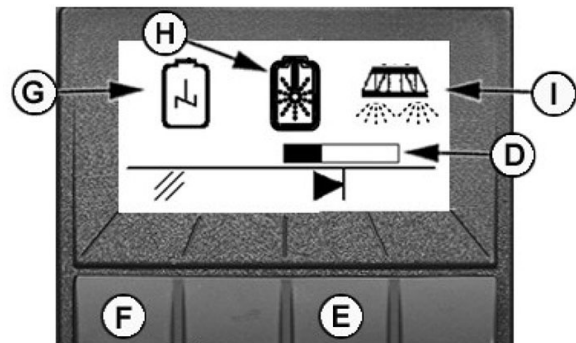
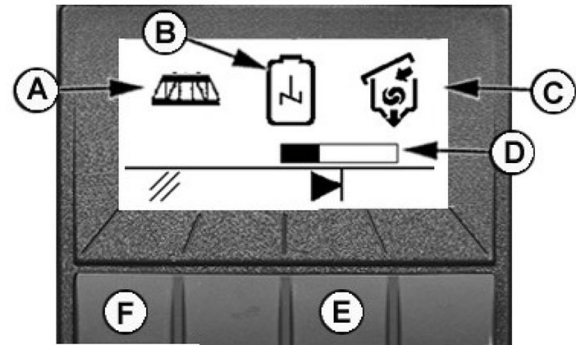

- A - Rinse Circulation System - N/A
- B - Rinse Agitation Boost (Inactive) - N/A
- C - Rinse Eductor Venturi Line
- D - Rinsing Progress Bar
- E - Skip Button
- F - Cancel Button
- G - Rinse Agitation
- H - Rinse Solution Tank
- I - Spray Out Residual Liquid

NOTE: System Rinse is monitored by the Progress Bar (D) shown on the micro display.

3. Spray out residual liquid by opening the spray master valve on the multi-function control handle in the cab.

Refer to the Rinse System section elsewhere in this manual for further information.

Boom Rinse

NOTE: After solution tank has been drained, complete the following steps when using System Rinse to rinse entire solution system or only the boom assembly.

NOTE: Using the Rinse Button (A) performs one rinse cycle for the System Rinse. The setting currently shown on the

display for the Rinse Cycle Volume (Low, Medium, or High) is used for the rinse cycle.

1. Press the Rinse Button (A) on the Solution Command System Keypad.



A - Rinse Button

2. Once the Boom Rinse is running, spray out residual liquid by opening the spray master valve on the multi-function control handle in the cab.

High-Pressure Washer

The High-Pressure Washer supplies clean water from the rinse water tank. Press the High-Pressure Washer Button (A) to turn ON. Press button again to turn OFF.

NOTE: An LED indicator on the button will illuminate when active.

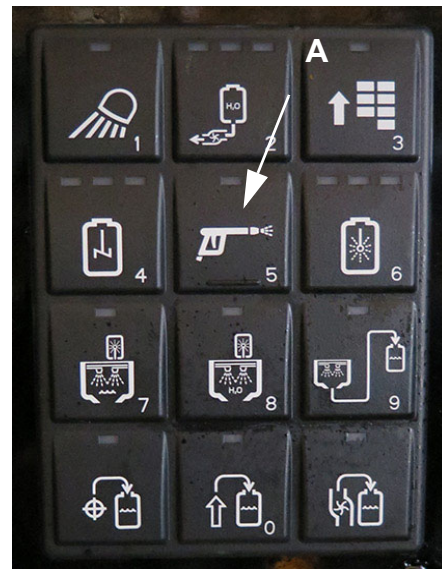

A - High-Pressure Washer Button

For further information, refer to the Accessories section in your machine operator's manual.

Solution Pump Maintenance and Operation Recommendations

Solution Pump Safety Recommendations/Decontaminate Spray Equipment

⚠ CAUTION

- Decontaminate work area before servicing. Flush, decontaminate, and drain pump(s) before servicing. Decontamination should be done in a safe area with water or neutralizing agent, or by means recommended by manufacturer of chemical last used.
- Spray materials can be extremely dangerous. Treat all spray chemicals, solutions, solution residues, or vapors with great caution. DO NOT take chances. When in doubt, proceed as though contamination is present.
- Keep spray material from contacting skin. If spray material contacts skin, wash off immediately with clean water and detergent or follow manufacturer's instructions for the chemical last used.

Avoid High-Pressure Fluids

⚠ CAUTION

- Escaping fluid under pressure can penetrate the skin causing serious injury.
- Avoid the hazard by relieving pressure before disconnecting hydraulic or other lines. Tighten all connections before applying pressure.
- Search for leaks with a piece of cardboard. Protect hands and body from high-pressure fluids.
- If an accident occurs, see a doctor immediately. Any fluid injected into the skin must be surgically removed within a few hours or gangrene can result. Doctors unfamiliar with this type of injury should reference a knowledgeable medical source. Such information is available from Deere & Company Medical Department in Moline, Illinois, U.S.A.

Avoid Flammable or Explosive Fluids

⚠ CAUTION

DO NOT pump flammable or explosive fluids such as gasoline, fuel oil, and kerosene. ONLY pump solutions compatible with pump components.

Prepare Machine

⚠ CAUTION

Remove key from the key switch before servicing pump(s).

Maintenance and Operation

(Inspect Vent Line)

IMPORTANT: To prevent pump damage from a dry run, vent line **MUST** be routed correctly and be free of obstructions so trapped air is bled from the pump chamber.

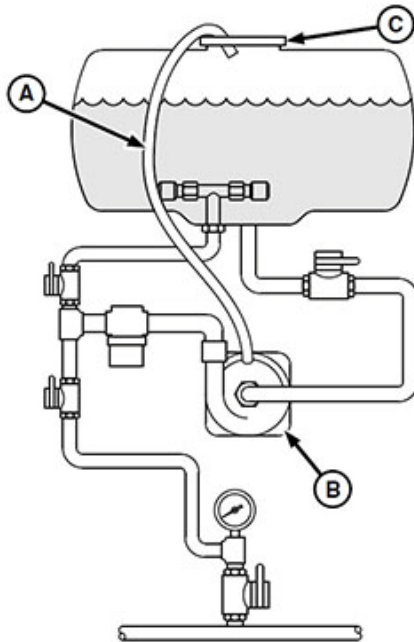

A - Vent Line
B - Solution Pump
C - Tank Top

Periodically verify the following:

- Verify Vent Line (A) runs on a continuous, upward slope (without horizontal sections or dips) from Solution Pump (B) to the Tank Top (C).
- Verify continuous stream of solution discharges from the vent line into the tank during pump operation. Best time to view discharge stream is with tank half full. Clean or replace the hose as needed.
- Verify that hoses and fittings are tight and in good condition.

Operate Machine Correctly

IMPORTANT: Chemicals and chemical residue left in the solution pump(s) for an extended period can be damaging to pump components. Rinse pump interior with clean rinse water daily and do not let chemical solution remain in the pump overnight. To

prevent pump damage from a dry run, **DO NOT** operate machine in a way that starves pump of solution and fills pump chamber with air.

As tank empties, operate machine as follows:

- Travel slowly over rough terrain to limit sloshing of solution, which causes pump inlet line to gulp air.
- Shut off pump(s) before tank is empty.

Prepare Pumps for Storage

Short-Term Storage - Flush pumps with water or neutralizing agent, such as Spray Tank Cleaner (N305631) or by means recommended by manufacturer of chemical last used. Drain pump.

Long-Term Storage - Follow same procedure as is outlined for short-term storage, then refill pump with 50-50 mix of SprayMaster™ Winterizer Fluid (N305634). **DO NOT** store pump with chamber dry.

Troubleshooting

SYMPTOM	PROBLEM	SOLUTION
Low discharge	<ul style="list-style-type: none"> • Pump(s) not primed. • Air leaks in the inlet line. • Blocked or clogged line filter. • Impeller clogged or blocked. • Impeller eye rubbing on volute (front casing) due to chemical-induced swelling. • Impeller eye rubbing on volute (front casing) due to pump running dry. 	<ul style="list-style-type: none"> • Inspect vent line. • Check and reseal inlet fittings. • Inspect strainer(s) and clear debris from screen(s). • Inspect impeller and clear obstruction. • Inspect impeller. Refer to the machine repair technical manual. • Inspect impeller for black or melted appearance. Reuse or replace impeller, depending on severity.
Mechanical Seal Leak	<ul style="list-style-type: none"> • Pump(s) ran dry. • Mechanical interruption of seal faces due to chemical solids getting in between seal faces. Leak is usually temporary. • Seal bellows torn due to chemical causing seal faces to stick together. 	<ul style="list-style-type: none"> • Replace seal. • Replace seal if leak persists. • Replace seal. Flush pump correctly in future.
Hydraulic Motor Leak	<ul style="list-style-type: none"> • Motor housing socket head screws are loose. • Oil seal failure. 	<ul style="list-style-type: none"> • Tighten screws to 20 N·m (15 lb-ft) • Replace oil seal. Inspect shaft, bearings, and oil “slinger” for damage and replace as needed.

Replace Nozzles

NOTE: Nozzles should be replaced when flow rate has increased by 10% from the desired rate at a given pressure.

Nozzles are a very important part of the sprayer. No matter how well-engineered the rest of the machine is, if the nozzles are bad, it is impossible to obtain good spray coverage. Therefore, it is extremely important to carefully choose the type and size of nozzles as well as maintain or replace them when needed.

As nozzles wear, their orifices increase in size. The monitor compensates for this by reducing pressure to maintain desired application rate. However, as nozzles wear, they begin to lose their overlap and may apply almost twice as much chemical or pesticide under the nozzles as they do between the nozzles.

Inaccurate spray pattern can cause chemical or pesticide to be ineffective in controlling weeds, pests, and disease. This can require another trip across the field with subsequent fuel and labor costs, as well as the use of more chemical or pesticide. This added expense is much more than the expense of replacing nozzles.

Spray Tip Types

Basic spray tip types are:

- High-Flow Flat Fan (fertilizer application)
- Ultra Low-Drift Flat Fan (herbicide application)
- Twin-Air Flat Fan (insecticide and fungicide application)
- Guardian Flat Fan (insecticide and fungicide application)

- Low-Drift Air (insecticide and fungicide application)
- Straight Stream Ceramic (fertilizer application)

Each spray tip type is designed to produce a specific spray pattern and are offered in different sizes to achieve desired application rate. Refer to the following information for a general description of each spray tip type.

Flat Fan Spray Tip

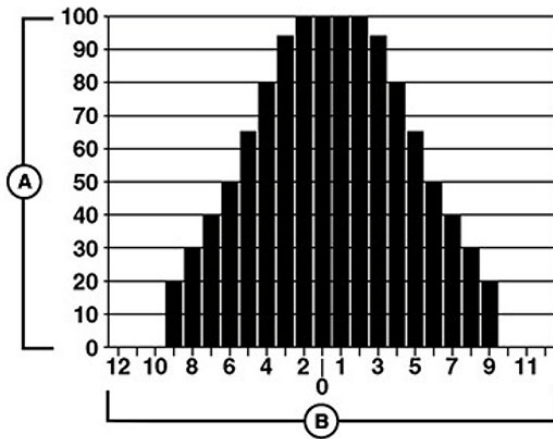
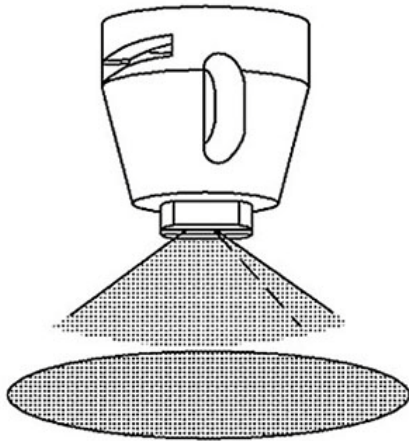

A - Coverage Percent
B - Distribution Profile

- Ultra Low-Drift
- Twin-Air
- Guardian
- Low-Drift Air

Flat Fan spray tips are an ideal choice for broadcast spraying when it is desirable to have a uniform amount of chemical applied across the entire width of the boom.

NOTE: Flat Fan spray tips apply solution in an elliptical pattern.

To achieve uniform application, it is necessary to overlap these spray tips. Usually this is done with spray tips spaced 508 mm (20 in) apart and positioned 457-559 mm (18-22 in) above the target surface. Most Flat Fan spray tips are designed to operate in the 207-414 kPa (2-4 bar) (30-60 psi) range.

Straight Stream Ceramic Spray Tip

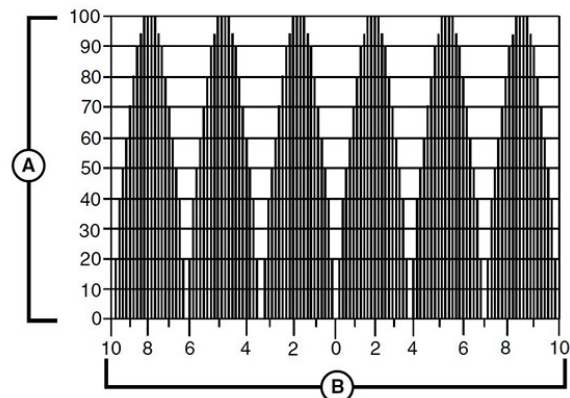
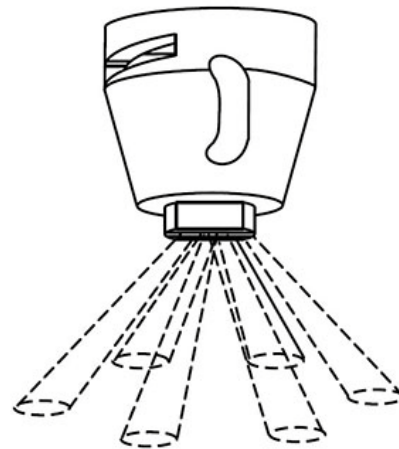

A - Coverage Percent
B - Distribution Profile

The Straight Stream Ceramic Tip is ideal for applying fertilizer into solid seeded crops. It creates six individual streams that distribute the fertilizer on the soil while

getting less on the crop. The ceramic metering orifice and unique low-pressure distribution chamber keep the streams stable to reduce atomization and prevent leaf burn and scorching. Spacing and spray height is similar to 110° broadcast tips.

Flat Fan High-Flow (Flood) Spray Tip

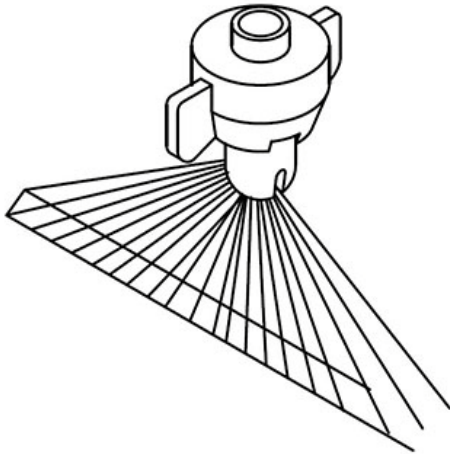

High Flow spray tips are used when high flow (2-6 gal/min is required). These application rates are typically required when applying liquid fertilizers. These provide a wide angled spray pattern (140°) to enable wider spaced machine setups while assuring excellent distribution. The multi-stepped, flow-regulating orifice and large atomization orifice produce a consistent pattern with reduced fine droplets, reducing drift potential. The product is a quick change design (one piece cap/tip with seal included) for convenient installation.

Use Spray Tip Calculator and Selector

Follow directions on the calculator to determine tip size.

Determining Effective Tip Spray Width

Instructions: Determine Effective Tip Spray Width using the appropriate diagram and formula below. Set Application Rate at Effective Tip Spray Width in window below. Read Tip Flow Rate at Vehicle Speed. See Side 2 for Tip Flow Rates at Pressure.

Broadcast Spraying
W = Nozzle Spacing (in.)

Band Spraying
W = Band Width (in.)
of Nozzles/Band

Directed Spraying
W = Row Spacing (in.)
of Nozzles/Row

DSPMS395BUS (12-10)

Side 1

Solution Density (lb/gal)

Specific Gravity (water = 1.0)

Solution Pressure (psi)

Pressure Range (◇ = rated pressure)

Instructions See Side 1 to determine necessary Tip Flow Rate.

If water-based solutions, set Solution Pressure at Water indicator, otherwise use Solution Density Scale to set Solution Pressure. Refer to Pressure Range Bars for recommended usage. Align Tip Flow Rate (from side 1) with desired Tip Type and Size.

WATER 20% SG = 1.20

Tip Type/Size

HCC: .03, .04, .06, .08, .10, .12, .17, .18

STC, TA, LDX, LDA, ULA, ULAC, LD, ER, FF, ES

FL: .20, .25, .30, .40, .5, .75, 1.0, 1.5, 2.0

HF: .20, .25, .30, .40, .5, .75, 1.0, 1.5, 2.0

HF – High Flow wide angle
STC – Straight Stream Ceramic
ULA – Ultra Low-drift Air
TA – Twin Air
LDX – Guardian
LDA – Low-drift Air
ULAC – Ultra Low-drift Air Ceramic

LD – Low Drift
ER – Extended Range
FF – Flat Fan
FL – Flood
ES – Even Spray
HCC – Hollow Cone Ceramic

Side 2

NOTE: Spray tip calculator may also be accessed at <http://nozzleselector.deere.com>. Calculator does not include all types of spray tips. Refer to the SprayMaster™ catalog if your spray tip type is not described. If damaged or lost, see your John Deere dealer for replacement.

Check and Replace Worn Nozzles

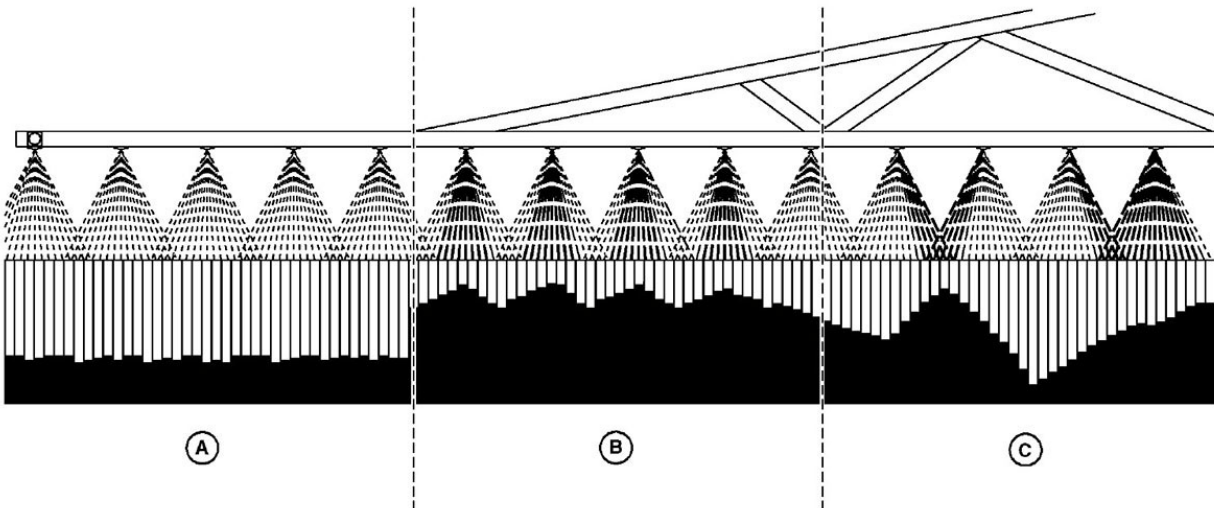

- A - NEW SPRAY TIPS** produce a uniform distribution when properly overlapped
- B - WORN SPRAY TIPS** have a higher output with more spray concentrated under each tip
- C - DAMAGED SPRAY TIPS** have a very erratic output (overlapping and under-applying)

A major cause of improper spray application is nozzle wear. Maintenance and timely inspection helps to identify worn nozzles and extend service life.

Over-application can cause:

- Crop damage
- Chemical carryover, affecting future crops
- Ground water contamination

Under-application may:

- Require additional field passes
- Cause inadequate weed, pest or disease control, all of which impact crop yields.

27.4 M (90 ft) Boom Flow Characteristics - Application Rate vs. Speed

NOTE: Ranges shown are based on water application.

Speed MPH (km/h)	Max Rate GPA (L/Ha) Single Pump/ Turrets	Max Rate GPA (L/Ha) Dual Pumps/ Turrets
0.1 (0.2)	14,055.3 (131,472.6)	23,251.3 (217,491.5)
5 (8.04)	281.1 (2,629.4)	465.03 (4,349.9)
6 (9.7)	234.3 (2,191.6)	387.5 (3,624.7)
7 (11.3)	200.8 (1,878.3)	332.2 (3,107.4)
8 (12.9)	175.7 (1,643.5)	290.6 (2,718.3)
9 (14.5)	156.2 (1,461.1)	258.4 (2,417.1)
10 (16.1)	140.6 (1,315.2)	232.5 (2,174.8)
11 (17.7)	127.8 (1,195.4)	211.4 (1,977.4)
12 (19.3)	117.1 (1,095.4)	193.8 (1,812.8)
13 (20.9)	108.1 (1,011.2)	178.9 (1,673.4)
14 (22.5)	100.4 (939.1)	166.1 (1,553.7)
15 (24.1)	93.7 (876.5)	155.01 (1,450.0)
16 (25.7)	87.9 (822.2)	145.3 (1,359.1)
17 (27.4)	82.7 (773.6)	136.8 (1,279.6)
18 (29.0)	78.1 (730.5)	129.2 (1,208.5)
19 (30.6)	74.0 (692.2)	122.4 (1,144.9)
20 (32.2)	70.3 (657.6)	116.3 (1,087.9)
21 (33.8)	66.9 (625.8)	110.7 (1,035.5)
22 (35.4)	63.9 (597.7)	105.7 (988.7)
23 (37.01)	61.1 (571.5)	101.1 (945.7)
24 (38.6)	58.6 (548.1)	96.9 (906.4)
25 (40.2)	56.2 (525.7)	93.01 (870.01)

Boom Spray Width

The following table shows the actual width of the area sprayed by each length boom with the indicated nozzle spacings.

BOOM SPRAY WIDTH		
Frame Length m (ft)	Nozzle Spacing mm (in)	Spray Width m (ft)
27.4 (90)	762 (30) - Off Center	27.4 (90)
27.4 (90)	1524 (60) - On Center	29.0 (95)

Nozzle Calibration

Frequency of Calibration

Even though a sprayer's operation can be determined using mathematical formulas, there are still many reasons to verify that the output is what it should be. For example,

- Wear (especially on nozzles)
- Damaged or malfunctioning parts (such as pressure gauges)
- Plugged or restricted passages (such as strainers and hoses)

Pre-season visual checks are not adequate for accurate application, nor is the fact that equipment and nozzle tips are new. Also, manufacturer's catalogs are only guidelines; fine-tuning a sprayer is the operator's responsibility.

A sprayer's output should be checked:

- After any adjustments
- When switching to a new chemical or application rate
- After a week of continuous use under the same circumstances

Verifying the results of an adjustment is standard procedure for all Hagie products. Never make adjustments to a sprayer without verifying the output from the nozzles.

Cost	Resulting In:
Wasted Resources	Over or under application of expensive chemicals
Reduced Yield/Quality	Chemical stress, pest pressure remaining
Effect on Future Crops	Chemical carryover

Calibration Procedure

Liters per Minute

$$\text{Tip Flow Rate (l/min)} = \frac{\text{Volume (L)} \times 60}{\text{Collection Time (sec)}}$$

OR

$$\text{Tip Flow Rate (l/min)} = \frac{\text{Volume (mm}^3\text{)} \times 60}{\text{Collection Time (sec)} \times 1000}$$

Gallons per Minute

$$\text{Tip Flow Rate (gpm)} = \frac{\text{Volume (gal)} \times 60}{\text{Collection Time (sec)}}$$

OR

$$\text{Tip Flow Rate (gpm)} = \frac{\text{Volume (ounces)} \times 60}{\text{Collection Time (sec)} \times 128}$$

To verify sprayer's output:

1. **Put clean water in the tank.** Never perform tests with chemical or fertilizer solution in the tank.
2. **Turn on the master spray and adjust pressure to desired level.** Engine speed should be the same as it would be under field conditions.
3. **Hold a graduated pitcher under a nozzle for a certain length of time.** Use a stopwatch or other watch that shows seconds to know how long the pitcher was collecting solution. Calculate the tip's flow rate as follows: $\text{Tip Flow Rate (l/min)} = \frac{\text{Volume Collected (L)}}{\text{Time to Collect (sec)}} \times 60$.
4. **Compare the tip's actual flow rate with the required flow rate.**
5. **Repeat Steps 3-4 with a couple nozzles in each section of the boom.** It is necessary to check several nozzles to get an average output. Even brand new nozzles will most likely not yield the exact flow rate expected.

SECTION 11 – WET SYSTEM



6. **Replace nozzles (if necessary).** If any nozzle varies from required flow rate by more than 10%, replace it. If two or more nozzles fail to pass, replace all nozzles.
7. **Adjust pressure (if necessary), then repeat entire procedure.** If average flow rate of the tips which were checked exceeds required flow rate, reduce pressure slightly. If average flow rate was too low, increase pressure slightly.

When spraying 32% nitrogen solution at 25 gallons per acre (GPA), the nozzle tips should be selected (using water) to deliver 28.75 GPA due to the higher density of nitrogen solution.

$25 \times 1.15 = 28.75$ (desired application rate x conversion factor = adjusted calibration rate for water)

NOTE: Target application rate remains at 95 l/min (25 GPA) since sprayer uses a flow-based system.

Conversion Factors (Calibrating For Carriers Other Than Water)

For the purpose of choosing nozzle sizes for carriers other than water, a conversion factor must be applied to desired application rate of solutions lighter or heavier than water. To match nozzle tip output to solution, multiply the desired application rate of solution (gallons per minute or gallons per acre) by the conversion factor listed to arrive at adjusted calibration rate (if using water).

Weight of Solution lb/gal (kg/l)	Example	Specific Gravity	Conversion Factor
7.00 (0.84)		0.84	0.92
8.00 (0.96)		0.96	0.98
8.34 (1.00)	Water	1.00	1.00
9.00 (1.08)		1.08	1.04
10.00 (1.20)		1.20	1.10
10.65 (1.28)	28% Nitrogen Solution	1.28	1.13
11.00 (1.32)	7-27-7 Fertilizer	1.32	1.15
11.06 (1.33)	32% Nitrogen Solution	1.33	1.15
11.40 (1.37)	10-34-0 Fertilizer	1.37	1.17
11.50 (1.38)	12-0-0-26 Fertilizer	1.38	1.17
11.60 (1.39)	11-37-0 Fertilizer	1.43	1.20
12.00 (1.44)		1.44	1.20
14.00 (1.68)		1.68	1.30

Install and Position Nozzle Tips and Strainers

1. Use the nozzle tip calculator to determine size of tips.
2. Install nozzle tips.
3. Position nozzles for desired spray pattern. Set flat or even nozzles (A-D) so the slot in the bottom is at right angles to the row.

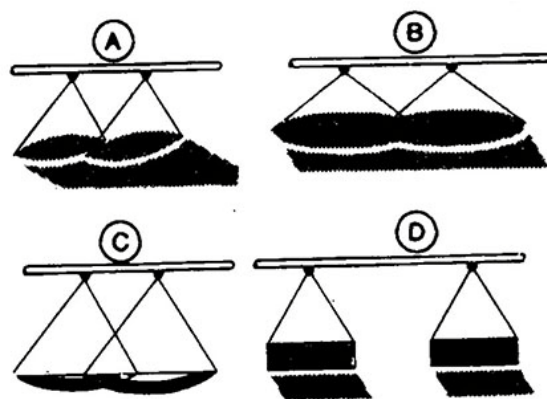

- A - Flat Spray (weed control, broadcast, pre-emerge)
 B - Cone Spray (insect control)
 C - Flood Spray (broadcast)
 D - Even Spray (banding)

4. Boom nozzle selection brackets are slotted (A) for adjustment. Loosen hardware to raise or lower the nozzle section.

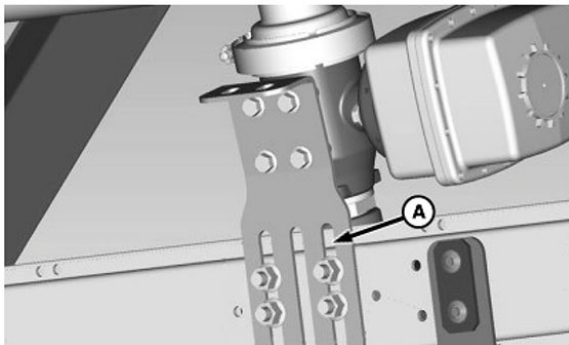
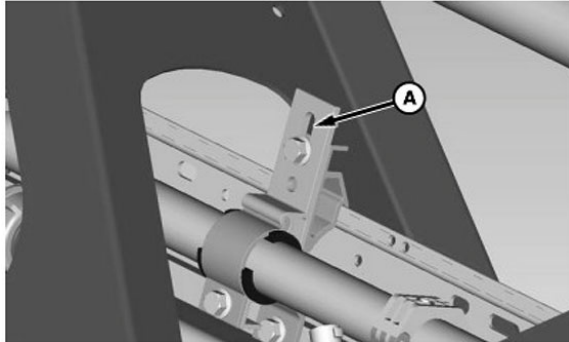

A - Slotted Adjustment Hole

5. Install strainers (if desired). Several different size mesh strainers are available (see your John Deere dealer).

6. Position nozzles for either broadcast sprayer (A-B) or banding (C-E).

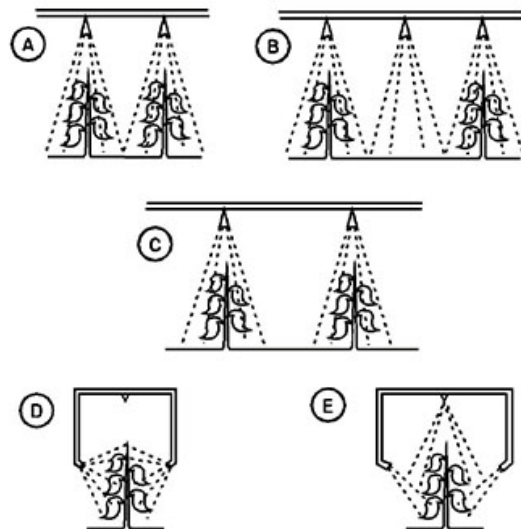

- A - One Nozzle per Row (broadcast)
 B - Two Nozzles per Row (broadcast)
 C - One Nozzle per Row (banding)
 D - Two Nozzles per Row (banding)
 E - Three Nozzles per Row (banding)

Standard Factory Equipment

The boom has 12 psi check valves as standard equipment. Optional check valves available through SprayMaster™ include 4, 8, 12, 20, and 25 psi settings. These pressures determine at what pressure nozzles shut OFF.

Optional check valve assembly size and colors

- 4 psi (orange plunger)
- 8 psi (black plunger)
- 12 psi (yellow plunger)
- 20 psi (gray plunger)
- 25 psi (blue plunger)

Diaphragms

- EPDM
- Viton (used at factory, better resistance to more chemicals)
- Cam-Lock (7 psi)

Clean SprayMaster™ 5-Position Nozzle Bodies - Standard Flow

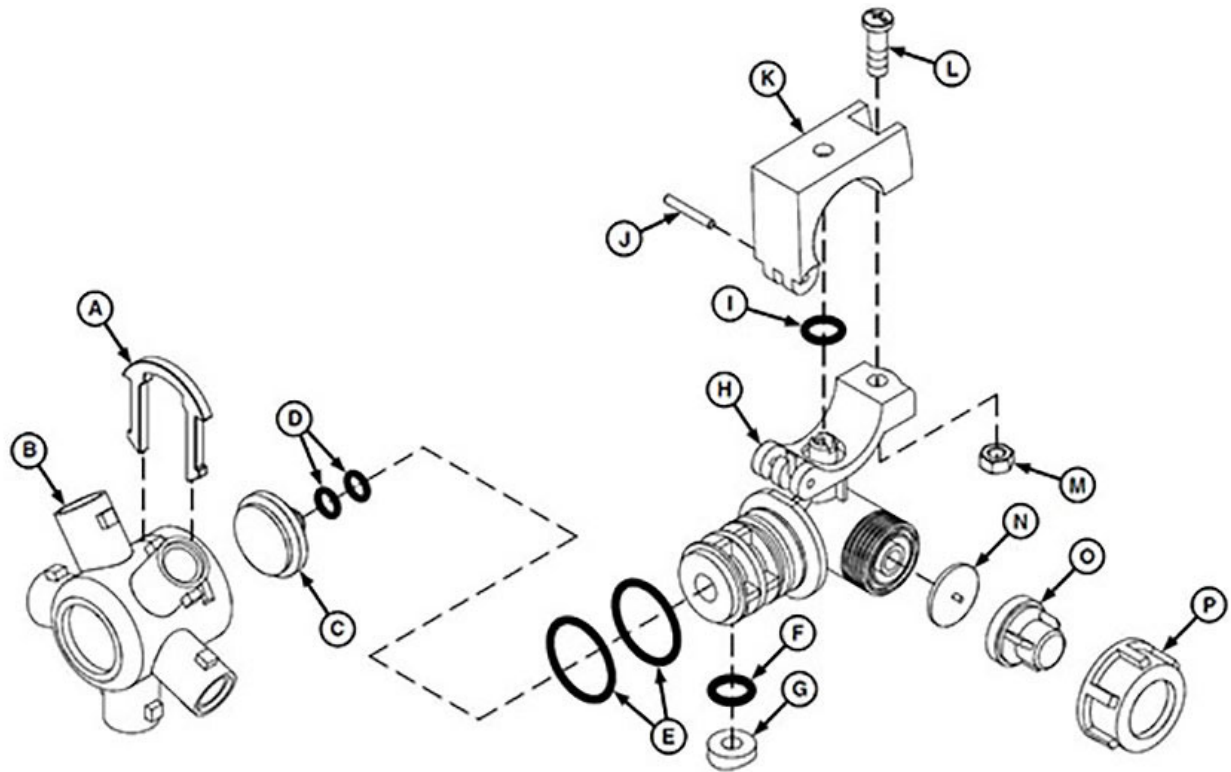

- A - Retainer
- B - Tip Holder
- C - Plug
- D - O-Rings
- E - O-Rings
- F - O-Ring
- G - Seal
- H - Nozzle Body

- I - O-Ring
- J - Pin
- K - Clamp
- L - Screw
- M - Nut
- N - Diaphragm
- O - Check Valve
- P - Cap

⚠ CAUTION

Keep spare nozzle tips for field replacement. **DO NOT** clean nozzle tips by placing in mouth and blowing or you could swallow or inhale hazardous chemicals which will poison, causing serious injury or death to you or others.

NOTE: Service life of plastic nozzle tips can be greatly extended by careful cleaning. Do not use metal tools for cleaning as they can scratch hardened surfaces, which accelerate wear and shortens service life. After cleaning nozzle body, apply a silicone-based lubricant to large o-ring on body.

IMPORTANT: Do not allow solvent or diesel fuel to contact rubber washers in caps, as it causes deterioration.

Solution Strainers

Solution Strainers are used to help keep dirt and debris from entering and damaging the solution pumps, nozzles, and other Liquid System components. Strainer screens should be removed and cleaned to maintain solution flow. (See “Clean Solution Strainers - Daily” in the Lubrication and Maintenance section).



A - Solution Strainers (2) - 50 Mesh

Eliminating Air from Solution System

Check for a suction leak using soapy water at all of the fitting and hose connections. Eliminate air coming from the nurse system by having a valve at the end of the fill hose. Always close this valve before disconnecting from the sprayer to ensure that air doesn't get into the system.

Boom Air Bleed Procedure

IMPORTANT: If performing this procedure after removing machine from storage, it needs to be performed after freezing is not an issue or done with winterizing fluid.

NOTE: Machine is equipped with spray pipe aspirators to aid in removing air from boom.

1. Fill solution tank with approximately 473 L (125 gal) of water.
2. Unfold and lower boom for access to nozzles.
3. Turn off all nozzle bodies except for the last nozzle body furthest from the machine centerline on all pipe assemblies. Remove the spray tip from these nozzle bodies.
4. Lower the center section and tilt both boom wings all the way up.
5. Run the sprayer in manual spray mode at 620.6 kPa (90 psi).
6. Cycle sprayer operation through a minimum of three (3) on-off cycles as follows to bleed trapped air from the booms:
 - a. Set the spray system master switch to ON and watch for water discharge from open nozzle bodies.
 - b. Set the spray system master switch to OFF and allow machine to sit for AT LEAST 15 seconds in OFF mode to allow air to move to high points.
7. Watch discharge from each open nozzle body for smooth, uniform output. Repeat on-off spray cycle until output is uniform. Continue spraying until only 189-283 L (50-75 gal) of water remains in the tank.
8. Rotate all nozzle bodies to spray position. Reinstall spray tips previously removed.

NOTE: If solution tank is loaded with a solution other than water and purging boom with water is not feasible, operator may tilt up booms all the way and spray for a short distance. This helps remove air from the system.

Troubleshooting Nozzles that Drip, Leak, or Seep After Valve is Shut Off

SYMPTOM	PROBLEM	SOLUTION
<p>Nozzles do not automatically shut off after the boom or master valve is turned off.</p> <p>Nozzles continue to drip or leak out several seconds after shut off.</p>	<ul style="list-style-type: none"> • Air leaks in the boom sections. • Issues in the nozzle bodies. • Suction hose damage. 	<ul style="list-style-type: none"> • Pressurize boom plumbing to check for air leaks on the hoses and fittings. Fix leaks. • Inspect nozzle bodies. Remove debris and replace damaged components. • Verify that hoses are in good condition. Replace as necessary.

Spray Pipe Aspirators

Spray Pipe Aspirators (A) are located at each end of the Spray Pipes (B). Aspirators are designed to allow air trapped at the top of spray pipes to be discharged through the first and last Nozzle Bodies (C). The aspirators have a Wide End (D) and a Narrow End (E) forming a funnel to the top side of the spray pipe. This forces solution to the top of the spray pipe, reducing the possibility of air pockets forming in the spray pipes on top of the spray solution.

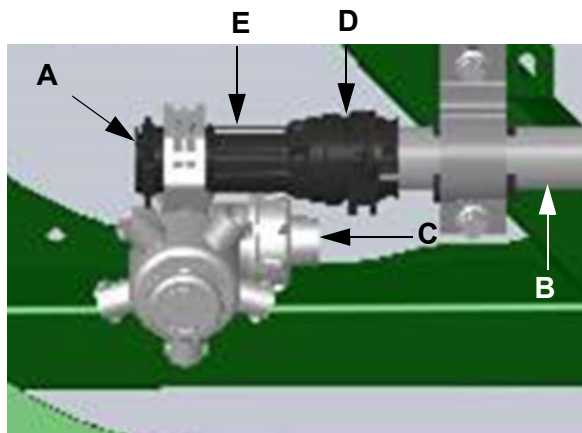

A - Spray Pipe Aspirator
B - Spray Pipe
C - Nozzle Body
D - Wide End
E - Narrow End

Boom Supply Air Bleed

The Boom Supply Air Bleed System consists of a Solenoid Valve (A) and Line (B). They are attached to the boom supply line just before the boom isolation valves and to the top of the solution tank. The system allows air trapped in the boom supply line to be released to the solution tank before entering the boom. The system activates automatically when the solution pump(s) are enabled. The solenoid opens until the first time the master ON spray function is activated. The solenoid valve then closes. This process is activated every time the solution pump switch is cycled on and off.

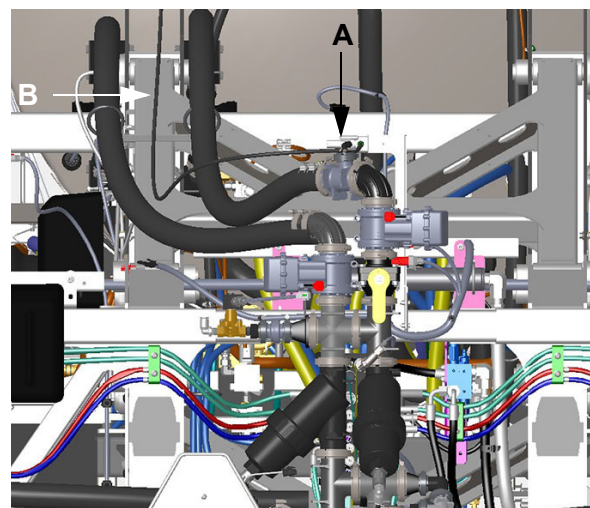

A - Solenoid Valve
B - Line



SECTION 12 – 27.4 M (90 FT) BOOMS

Boom Unfold/Fold - 27.4 m (90 ft) Booms

Full Boom Auto Unfold/Fold

CAUTION

Spray booms move quickly. Keep everyone out of the folding/unfolding area of the spray booms. Failure to comply can result in injury or death.

NOTE: Machine must be traveling less than 8 km/h (5 mph) and transport lock must be disengaged to unfold or fold the boom.

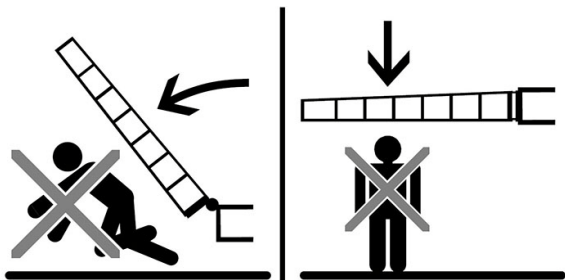

To Unfold

1. Press and hold the Boom Floor Switch (A).

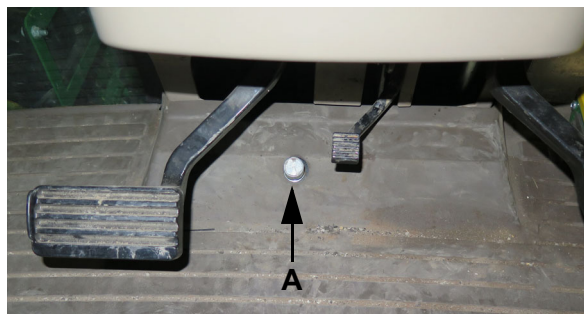

A - Boom Floor Switch

2. Press and hold bottom of the Center Boom Switch (B). All boom sections on both sides now unfold completely. Once booms have completely unfolded, release switches.
3. Press bottom of the Center Boom Switch (B) until boom is lowered to desired height. Release switch.
4. Press bottom of the Left Boom Switch (C) to lower left boom to desired height. Press bottom of the Right Boom Switch (D) to lower right boom to desired height.



B - Center Boom Switch
C - Left Boom Switch
D - Right Boom Switch

SECTION 12 – 27.4 M (90 FT) BOOMS



To Fold

5. Press and hold the Boom Floor Switch (A).

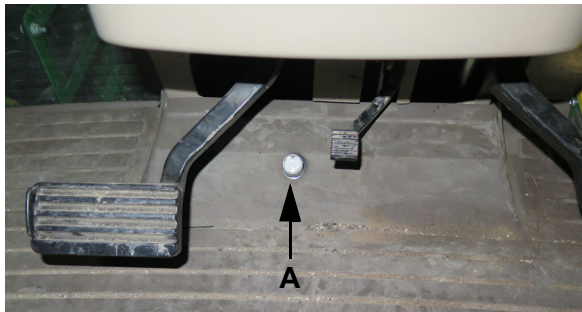

A - Boom Floor Switch

6. Press and hold Center Boom Raise Switch (B). Booms now raise completely and fold in towards the machine. Once booms are completely folded in against the machine and lowered into cradles, release switches (A and B).



B - Center Boom Raise Switch
C - Center Boom Lower Switch

Full Boom Sequential Unfold/ Fold

CAUTION

Spray booms move quickly. Keep everyone out of the folding/unfolding area of the spray booms. Failure to comply can result in injury or death.

NOTE: Machine must be traveling less than 8 km/h (5 mph) and transport lock must be disengaged to unfold or fold the boom.

NOTE: Corresponding boom sections on either side will unfold sequentially, stopping after each section is unfolded. The operator must release the unfold button and re-actuate to continue the unfold procedure.

NOTE: The booms are designed so that only one boom can be unfolded/folded if desired. (See "Unfolding/Folding One Side" elsewhere in this section).

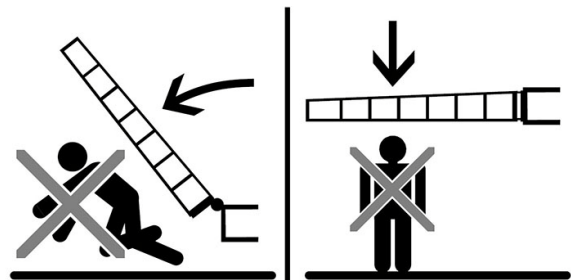

To Unfold

1. Press and hold Center Boom Raise Switch (A) to raise boom to highest position.

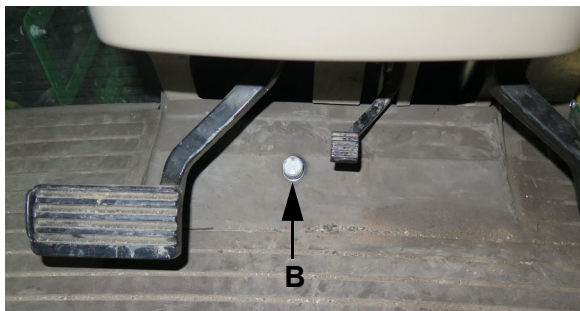

**A - Center Boom Raise Switch
B - Boom Floor Switch
C - Center Boom Lower Switch
D - Left Boom Switch
E - Right Boom Switch**

2. Press top of Right and Left Boom Switches (E and D) to raise booms out of cradles.
3. Press and hold Boom Floor Switch (B) and bottom of Right and Left Boom Switches (E and D) until inner wings are unfolded.

4. Release Right and Left Boom Switches (E and D) and press again until outer/breakaway sections are unfolded. Release switches.
5. Press Center Boom Lower Switch (C) to position nozzles at desired height.
6. Press Left Boom Lower Switch (D) to lower left boom to desired height. Press Right Boom Lower Switch (E) to lower right boom to desired height.

To Fold

7. Press and hold Center Boom Raise Switch (A) until booms are fully raised.

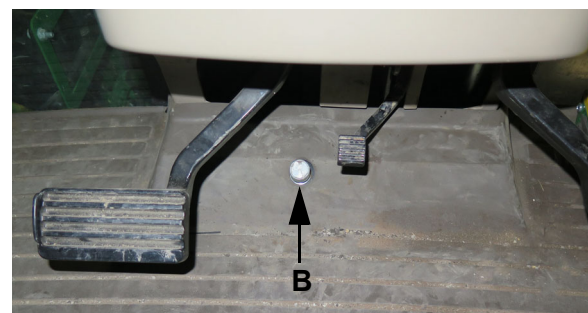

**A - Center Boom Raise Switch
B - Boom Floor Switch
C - Center Boom Lower Switch
D - Left Boom Switch
E - Right Boom Switch**

8. Press and hold Boom Floor Switch (B).

SECTION 12 – 27.4 M (90 FT) BOOMS



9. Press and hold Left and Right Boom Switches (D and E) to fold outer/breakaway sections.
10. Press and hold Left and Right Boom Switches (D and E) to fold inner sections. Release Boom Floor Switch (B).
11. Lower boom to cradles and release switches.

Unfolding One Side

1. Press and hold Center Boom Raise Switch (A) to raise boom to highest position.

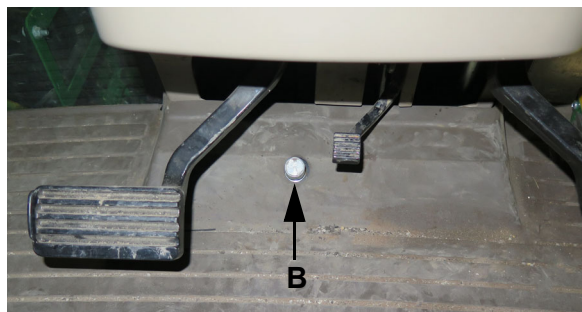

- A - Center Boom Raise Switch
- B - Boom Floor Switch
- C - Left Boom Lower Switch
- D - Right Boom Lower Switch
- E - Center Boom Lower Switch

2. Press and hold Boom Floor Switch (B) and Left or Right Boom Switches (C or D) until inner section of the corresponding boom is unfolded.
3. Release Left or Right Boom Switches (C or D) and press again until outer/breakaway section is unfolded.

NOTE: Both sides may be unfolded simultaneously if desired.

4. Release switches.

Folding One Side

1. Press and hold Boom Floor Switch (A) and Left or Right Boom Switch (B or C) until breakaway/outer wing on the corresponding side is folded.

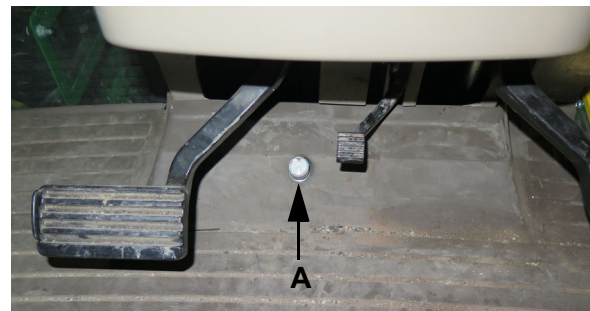

- A - Boom Floor Switch
- B - Left Boom Raise Switch
- C - Right Boom Raise Switch
- D - Center Boom Lower Switch

2. Release Left or Right Boom Switch (B or C) and press again until inner section is folded. Center section raises as inner section folds.

NOTE: Both sides may be folded simultaneously by pressing both Left and Right Boom Switches (B and C) simultaneously if desired.

3. Release switches.

Boom Maintenance Mode

Boom Maintenance Mode allows the operator to fold or unfold each section individually for boom service or repair (see “Boom Maintenance Mode” in the Calibrations section for further information).

Spray with Boom at 18.3 m (60 ft)

IMPORTANT: When Cam-Lock plumbing is being used, the operator cannot spray with the boom in the folded position, as the nozzles will spray on the boom.

1. Fold boom to 18.3 m (60 ft). See “Boom Folding - 27.4 (90 ft)” for folding instructions.
2. Disable the outer and breakaway sections using the display (see “Boom Sections | Custom” in the Booms section).

NOTE: Spray rate control automatically adjusts for spraying at 18.3 m (60 ft).

3. To spray with the entire boom, enable all boom sections and unfold boom.

Full Boom Breakaway

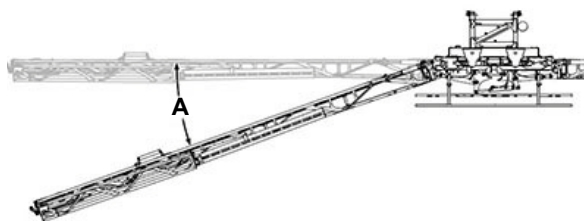

CAUTION

Serious injury or death to you or others can occur from standing in front of boom when it is returning to its original position. Full boom breakaway system is under hydraulic pressure. If the boom must be lifted or aided over an object or an obstruction, stand behind the boom to avoid injury.

The full boom breakaway system provides boom damage protection to the inner booms when the outer boom section is folded in or the inner section strikes an object. The system allows the boom to breakaway 28° (A). Once the operator backs away or clears the struck object, the boom returns to its original position.

Adjust Breakaway Section Springs

IMPORTANT: Perform breakaway stop adjustment before adjusting breakaway spring. Stop position can affect spring setting. Always verify spring setting after any adjustment to breakaway stop.

1. Adjust Nut (A) to obtain 7 mm (0.28 in) Gap (B) between Pivot Casting (C) and Chain Link (D).

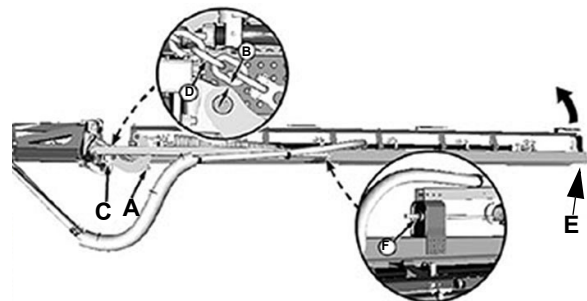

- A - Nut
- B - Gap
- C - Pivot Casting
- D - Chain Link
- E - End of Breakaway Section
- F - Nut

SECTION 12 – 27.4 M (90 FT) BOOMS



2. Attach spring scale at outer end of Breakaway Section (E).
3. Pull Breakaway Section rearward using scale. Record force required to trip the breakaway.
4. Adjust Nuts (F) and (A) to obtain a trip force of 270 N (60 lb) while maintaining proper gap between the Chain Link and Pivot Casting.

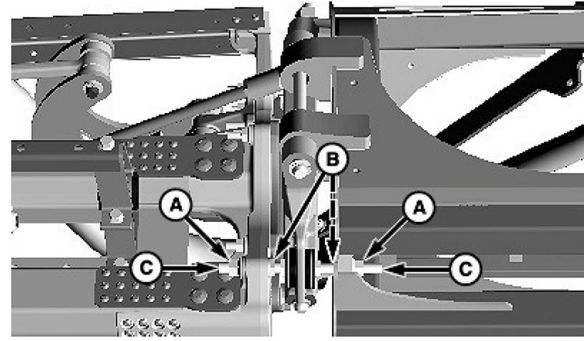

A - Nuts
B - Nuts
C - Stops

Adjust Outer Boom Section Stop Bolt

1. Loosen Lock Nut (A).

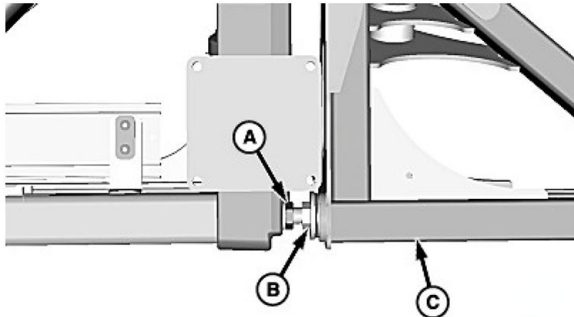

A - Lock Nut
B - Stop Bolt
C - Outer Section

2. Adjust outer boom section Stop Bolt (B) in or out so that Outer Section (C) is in line with the rest of the boom.
3. Re-tighten Lock Nut.

Adjust Breakaway Stop

IMPORTANT: Verify breakaway spring setting after adjusting breakaway stop.

Use Nuts (A) and (B) to adjust Stops (C) so that breakaway section is in alignment with outer boom section.

Adjust Outer Fold Cylinder

IMPORTANT: Park machine in an area with adequate room to fold and unfold the spray boom.

Adjusting Cylinder for Unfolded Boom Position

1. Unfold spray boom completely.
2. Verify that stop bolt is adjusted correctly (see “Adjust Outer Boom Section Stop Bolt” in this section).

3. Push spray boom forward, by hand, at outer end of the outer spray boom.
 - a. If spray boom stays in contact with the spray boom stop bolt at location (A), then cylinder is adjusted correctly.
 - b. If spray boom does not stay in contact with the spray boom stop bolt at location (A), then cylinder is adjusted incorrectly. Continue with this procedure to adjust the cylinder.

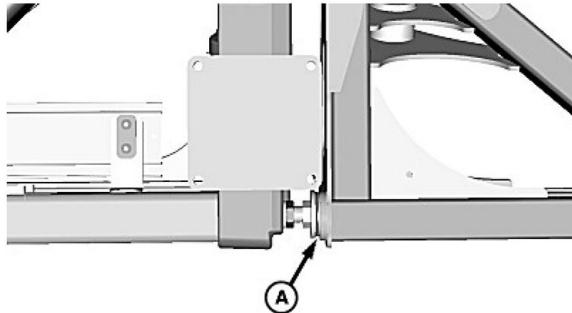

Correct Cylinder Adjustment

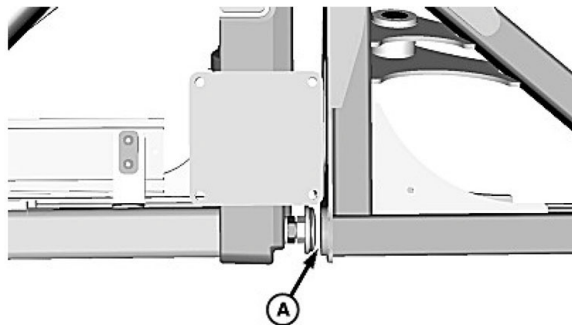

Incorrect Cylinder Adjustment

A - Location

4. Fold spray boom slightly to relieve pressure on cylinder.

5. Loosen Nut (A) and rotate the Cylinder Rod (B) to extend length.

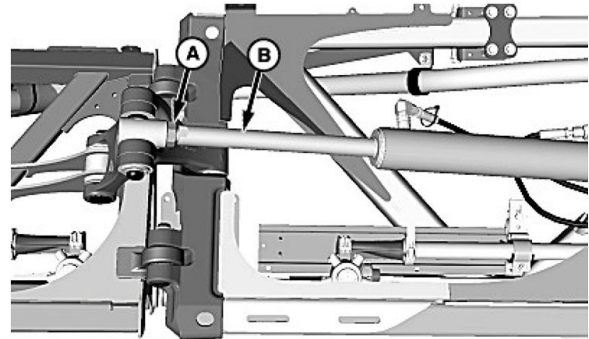

**A - Nut
B - Cylinder Rod**

6. Tighten nut to specification.

Specification	
Outer Fold Cylinder Nut - Torque.....	508 N·m (375 lb-ft)

7. Unfold spray boom completely.
8. Push spray boom forward, by hand, at outer end of the outer spray boom.
 - a. If spray boom does not stay in contact with the spray boom stop bolt, repeat steps for lengthening cylinder. Repeat as necessary.
 - b. If spray boom stays in contact with the spray boom stop bolt, then cylinder is adjusted correctly. Proceed to “Adjusting Cylinder for Folded Boom Position”.

SECTION 12 – 27.4 M (90 FT) BOOMS



Adjusting Cylinder for Folded Boom Position

1. Fold outer spray boom to the inner spray boom. Verify that Spray Boom Stop (A) is contacting Inner Wing (B).
 - a. If spray boom stop is not contacting Inner Wing, then adjust the cylinder. Continue procedure.
 - b. If spray boom stop is contacting Inner Wing, continue procedure.

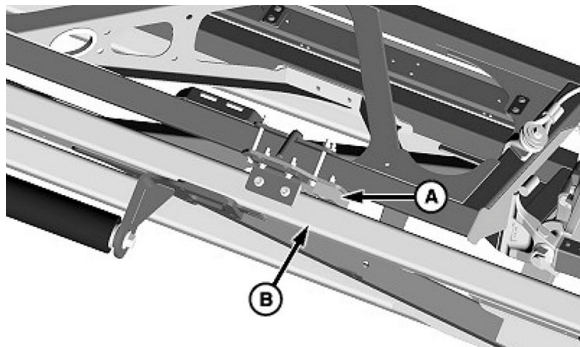

Touching - Correct Cylinder Adjustment

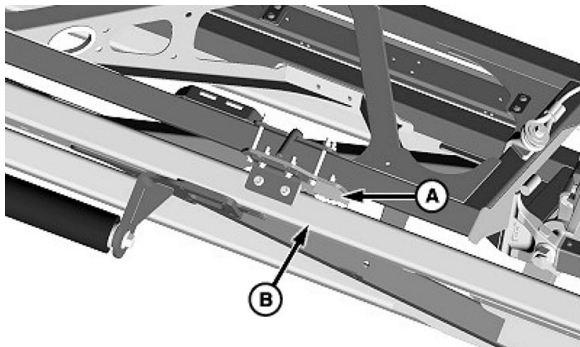

Pulled Away - Incorrect Cylinder Adjustment

A - Boom Stop
B - Inner Wing

2. Pull outer wing away from the inner wing.
 - a. If outer spray boom stop stays in contact with the inner wing, then cylinder is adjusted correctly.
 - b. If spray boom stop is not contacting inner wing, then adjust the cylinder.
3. Unfold spray boom slightly to relieve pressure on cylinder.

4. Loosen Nut (A) and rotate the Cylinder Rod (B) one turn to shorten length.

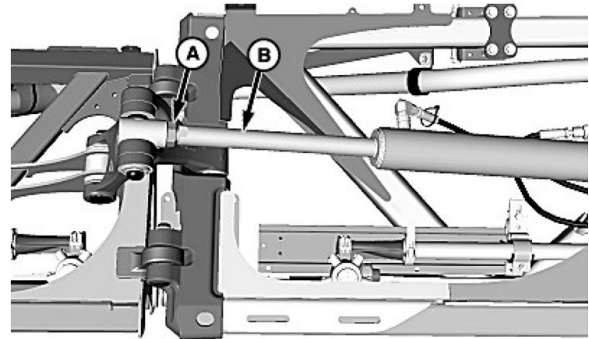

A - Nut
B - Cylinder Rod

5. Tighten nut to specification.

Specification
Outer Fold Cylinder Nut - Torque.....508 N·m (375 lb-ft)

6. Fold outer spray boom to the inner spray boom completely.
7. Pull outer wing away from the inner wing.
 - a. If outer spray boom stop stays in contact with the inner wing, then cylinder is adjusted correctly for folded position. Perform “Adjusting Cylinder for Unfolded Boom Position” to verify that cylinder adjustment is correct for unfolded position.
 - b. If outer spray boom stop does not stay in contact with the inner wing, repeat steps for shortening cylinder. Repeat as necessary.

Adjust Inner Fold Cylinder

1. Level and raise boom to highest position and fold in against boom stops.

- Loosen Lock Nut (A) and turn the Cylinder Rod (B) (in or out as needed) until boom is directly above boom rest and will not bind when lowered into the transport position.

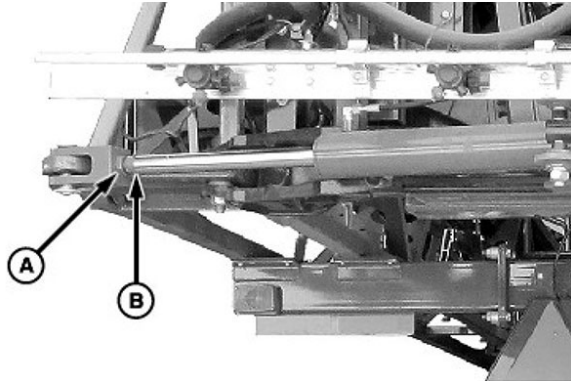

A - Lock Nut
B - Cylinder Rod

- Tighten Lock Nut to specification.

Specification	
Inner Fold Cylinder Jam Nut - Torque.....	508 N·m (375 lb-ft)

Adjust Outer Wing Rest

IMPORTANT: Do not adjust Outer Wing Rest (A) before outer fold cylinder is correctly adjusted (see “Adjust Outer Fold Cylinder” in this section for further information).

- Loosen Cap Screws (B).
- Adjust outer wing rest to obtain contact with Inner Wing (C).
- Re-tighten cap screws.

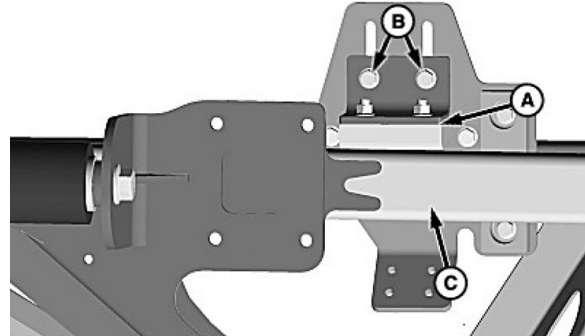

A - Outer Wing Rest
B - Cap Screws
C - Inner Wing



SECTION 13 – LIQUID SYSTEM REMOVAL/INSTALLATION

Liquid System Removal and Installation

Contact your local John Deere dealer.



SECTION 14 – LUBRICATION AND MAINTENANCE

Clean Vehicle of Hazardous Chemicals, Including Pesticides

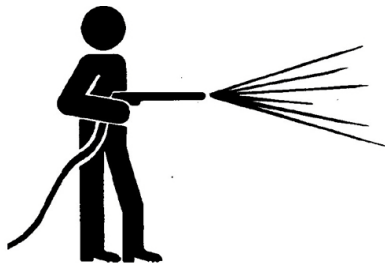

⚠ CAUTION

During application of hazardous chemicals, including pesticides, residue can build up on the inside and outside of the vehicle. Clean vehicle according to use instructions of hazardous chemical.

When exposed to hazardous chemicals, clean exterior and interior of vehicle daily to keep free of the accumulation of visible dirt and contamination.

1. Sweep or vacuum the floor of cab.
2. Clean headliners and inside cowlings of cab.

IMPORTANT: Directing pressurized water at electronic/electrical components or connectors, bearings and hydraulic seals, fuel injection pumps, or other sensitive parts and components may cause product malfunctions. Reduce pressure and spray at a 45 to 90-degree angle.

3. Wash entire exterior of vehicle.
4. Dispose of any wash water with hazardous concentrations of active or non-active ingredients according to published regulations and directives.

Prevent Hydraulic System Contamination

IMPORTANT: Cleanliness is very important when working on the hydraulic system. Prevent contamination by assembling the cylinders, hoses, couplers, and valves in a clean area of the shop. Leave protective caps on the fluid openings until ready to make the connection. When charging the system, use a tractor or other source that contains clean oil, free of abrasive materials. Keep couplers clean. Abrasive particles, like sand or metal fragments, can damage seals, barrels, and pistons, causing internal leakage.

Dispose of Waste Properly

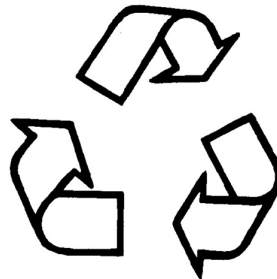

- Improperly disposing of waste can threaten the environment and ecology. Potentially harmful waste used with Hagie equipment includes such items as oil, fuel, coolant, brake fluid, filters, and batteries.
- Use leak-proof containers when draining fluids. Do not use food or beverage containers that may mislead someone into drinking from them.
- Do not pour waste onto the ground, down a drain, or into any water source.
- Air conditioning refrigerants escaping into the air can damage the earth's atmosphere. Government regulations

SECTION 14 – LUBRICATION AND MAINTENANCE



may require a certified air conditioning service center to recover and recycle used air conditioning refrigerants.

- Inquire on the proper way to recycle or dispose of waste from your local environmental or recycling center, or from your John Deere dealer.

Service Intervals

SERVICE	INTERVAL					
	10 Hours/ Daily	As Required	25 Hours	50 Hours	200 Hours	1000 Hours/ Annually
** Perform at initial break-in ▪ Required service interval *** Perform after initial interval						
Check hydraulic oil level	▪					
Clean oil cooler	▪					
Lubricate boom lift arm pins	▪					
Clean solution strainers	▪					
Adjust boom breakaway tension		▪				
Clean aspirators, nozzle bodies, and tips		▪				
Check solution tank straps (for tightness)		▪				
Clean solution system			▪			
Inspect hydraulic hoses				▪		
Inspect liquid system/boom structure					▪	
Change hydraulic oil and filters						▪
Inspect hydraulic relief valves						▪
Inspect boom pivot bushings						▪
Clean sprayer and coat exposed surfaces						▪

Check Hydraulic Oil Level - Daily

Observe oil level in Hydraulic Oil Reservoir Sight Gauge (A) with the machine on a level surface and engine OFF. Sight Gauge Decal (B) shows the proper oil level based on current oil temperature. Verify that oil level is within the proper range.

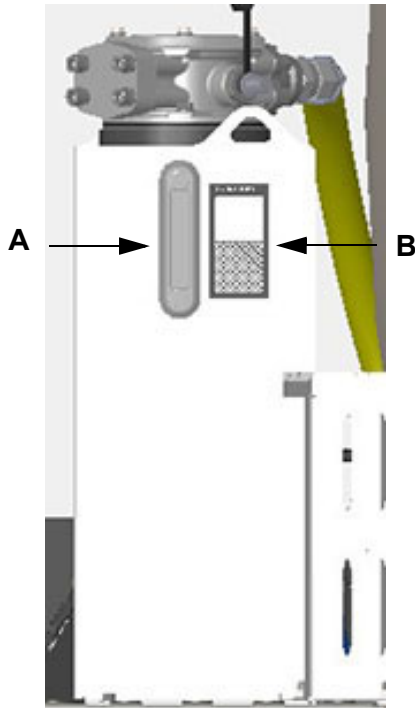

A - Hydraulic Oil Reservoir Sight Gauge
B - Sight Gauge Decal

If oil level is below the low mark for the current temperature range, add hydraulic oil (see “Transmission and Hydraulic Oil” in the Lubricant Specifications section of your machine operator’s manual).

Clean Oil Cooler - Daily

Clean dirt and debris from oil cooler (A) daily.

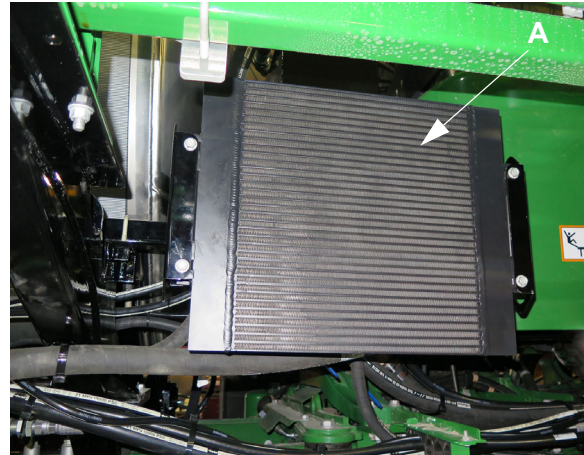

A - Oil Cooler

Lubricate Boom Lift Arm Pins - Daily

NOTE: Left-hand side shown, right-hand side similar.

Lubricate boom lift arm pins with John Deere SD Polyurea grease daily using front grease fittings (A), grease bank (B), and grease fitting (C).

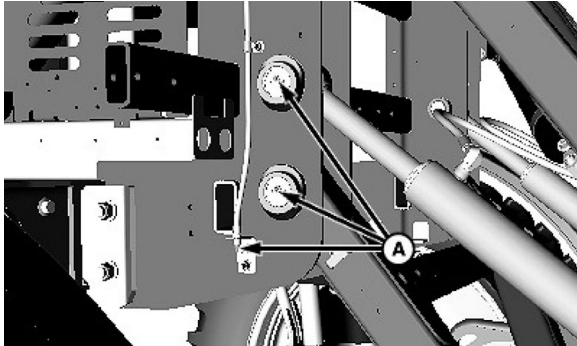

Front Grease Fittings

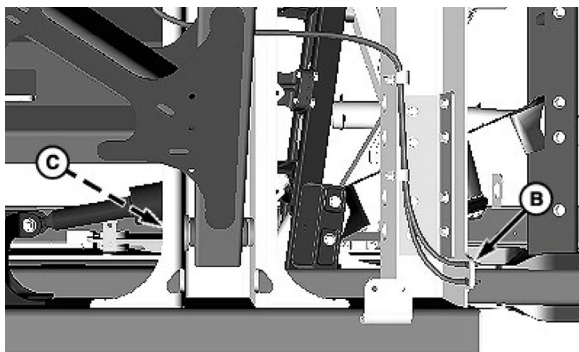

Rear Grease Fittings

A - Front Grease Fitting

B - Grease Bank

C - Grease Fitting

Clean Solution Strainers - Daily

⚠ CAUTION

The spray system contains hazardous material, which can cause serious injury or death to you or others. Wear protective clothing, eyewear, and gloves. Drain solution and clean strainers in an area where people, animals, vegetation, and water supply cannot be contaminated.

Clean solution strainers if the following conditions exist:

- Solution pump fails to obtain maximum flow rate.
- Solution pump fails to maintain dead head pressure.
- Application rates fluctuate.
- Difference between solution pump pressure and spray pressure is greater than expected for a given application.

⚠ CAUTION

Do not close the flowmeter shutoff valve with the solution pump running. This can trap pressure in the system that can be hazardous when opening strainers for cleaning.

⚠ CAUTION

Do not drain solution onto the ground. Drain into a suitable container. Drain solution in an area where people, animals, vegetation, and water supply cannot be contaminated.

1. Close valves to prevent excessive solution loss.
 - a. Shut engine OFF (when engine is off, both the electric Standard Flow Valve (A) and High Flow Valve (B) will be off).
 - b. Ensure Manual Fill Button (C) is OFF.

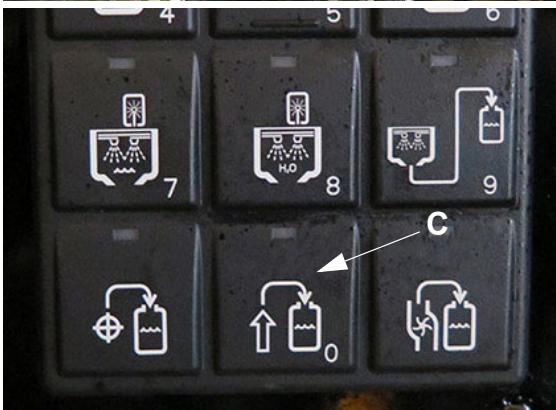
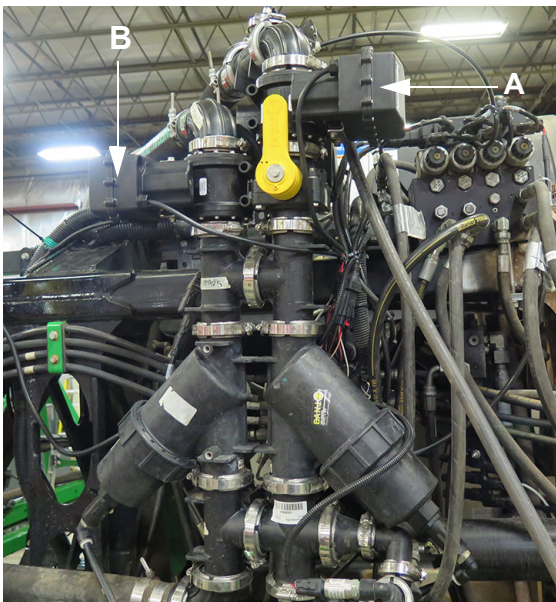

A - Standard Flow Valve
B - High Flow Valve
C - Manual Fill Button

NOTE: Electric valves require more solution be drained through the strainer. Ensure the container has sufficient capacity.

2. Open Strainer Drain Valve (A)* and drain solution into a suitable container through Drain Hose (B)*.

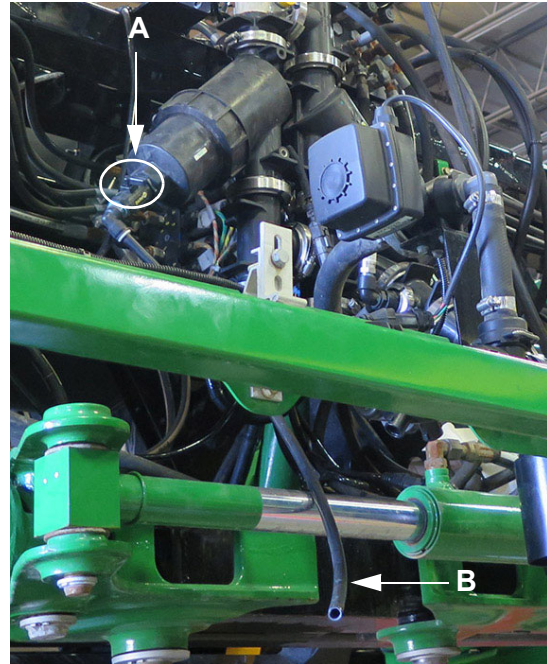

A - Strainer Drain Valve (2)
B - Strainer Drain Hose (2)

** Equipped with two (2) Strainer Drain Valves and two (2) Strainer Drain Hoses.*

3. Unscrew Strainer Ring (A)* and remove Strainer Housing (B)*.

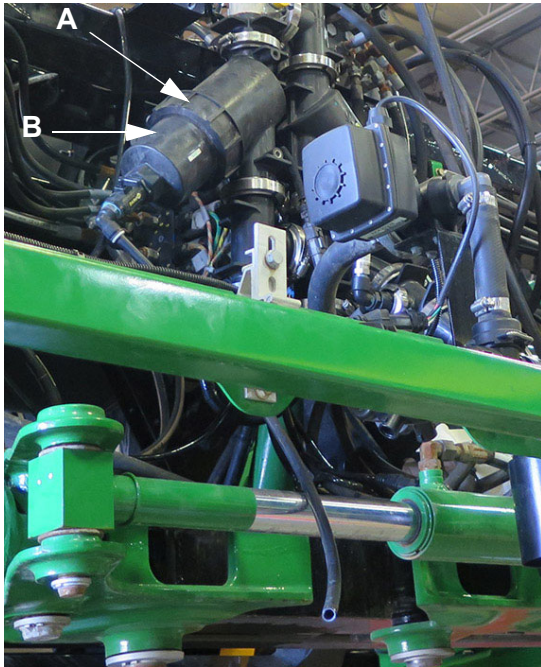

A - Strainer Ring (2)
B - Strainer Housing (2)

* Equipped with two (2) Strainer Rings and two (2) Strainer Housings.

4. Remove strainer screens and wash with clean water.
5. Reinstall strainer screens and housings.
6. Close the strainer drain valves.

1. Relieve boom pressure. (See “Pressure Relief” in the Liquid System section).
2. Remove Aspirator (A), Nozzle Body (B), or tip. Catch solution in a suitable container.

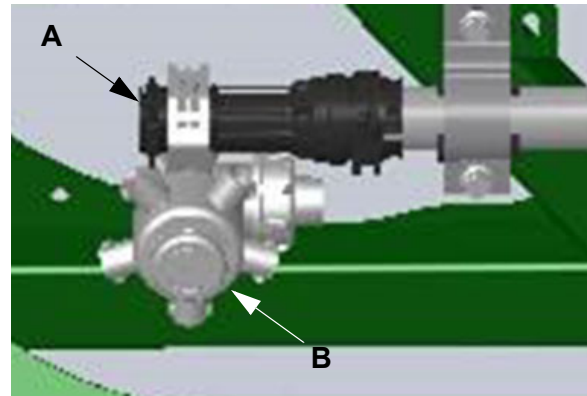

A - Aspirator
B - Nozzle Body

NOTE: Soak components in cleaning solution to dissolve chemical residue if needed.

3. Clean components of chemical deposits.
4. Install all previously removed components and check for leaks.

Clean Aspirators, Nozzle Bodies, and Tips - As Required

⚠ CAUTION

The spray system contains hazardous material, which can cause serious injury or death to you or others. Wear protective clothing, eyewear, and gloves. Drain solution in an area where people, animals, vegetation, and water supply cannot be contaminated.

Check Solution Tank Straps - As Required

NOTE: Rear strap shown, front strap similar.

Check solution tank straps (front and rear) yearly. Tighten straps as required to remain snug.

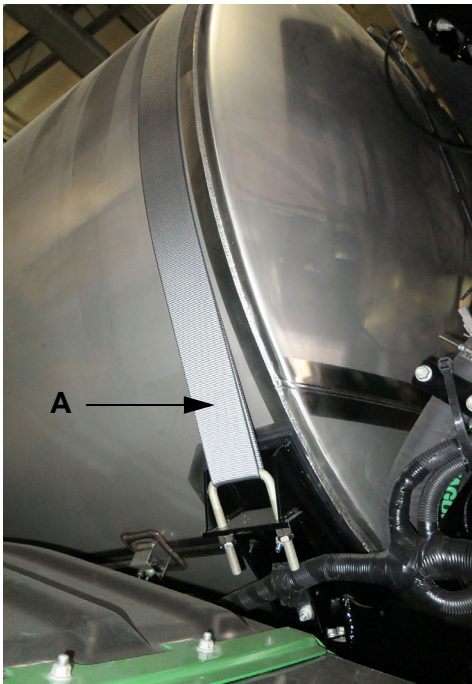

A - Tank Strap (2)

Solution System Cleaning - 25 Hours

NOTE: Perform solution system cleaning every 25 hours of operation, particularly when spraying suspended solutions.

⚠ CAUTION

Wear personal protective equipment (PPE) in accordance with chemical manufacturer's label.

⚠ CAUTION

Drain solution in an area where people, animals, vegetation, water supply, etc. cannot be contaminated. Cleaning should be done in a safe area by washing with water, neutralization, or by means recommended by the chemical manufacturer.

1. Load solution tank with 400 gallons (1514 L) of fresh water.
2. Remove tips from all nozzles (BOTH cam-locks and turrets), including fence row nozzles.
3. Remove both solution strainers from their housings.
4. Reinstall strainer housings without the strainer.
5. Soak strainers in a container with a mixture of water and John Deere tank cleaner (N305631) (follow mixing instructions on product label).
6. Open all manual valves (flow restriction valve/dual flow meter valve).
7. Operate the eductor rinse and flush with fresh water for approximately 10 minutes.
8. Allow agitation to run for approximately 15 minutes with fresh water.
9. After flushing the entire wet system, spray the contents of solution tank through the boom (BOTH cam-locks and turrets, even if not used).
10. Load the rinse tank with fresh water.
11. Complete a minimum of one rinse cycle.

IMPORTANT: DO NOT spray rinsate out of the boom at the end of this cycle.

12. Mix the correct amount of John Deere tank cleaner (N305631) with water (follow mixing instructions on product label).
13. Using the eductor hopper, load tank cleaner mixture into the system. DO NOT pour into the top of tank.

SECTION 14 – LUBRICATION AND MAINTENANCE



14. Ensure the eductor hopper rinse is operating to verify the eductor hopper is clean and decontaminated.
15. Operate the eductor hopper rinse for approximately 10 minutes.
16. Spray a small amount of the solution tank contents out of the boom to allow the cleaning fluid to reach the nozzles.

NOTE: If the machine is equipped with fence row nozzles, spray a small amount of cleaning fluid out of these nozzles as well.

17. Allow the machine to sit overnight with rinsate solution in the tank, lines, and boom before completing the following steps.

IMPORTANT: If temperature will fall below 32° F, take the proper precautions to avoid freezing, but DO NOT add winterizer fluid to the tank mixture. If no option is available to allow overnight soak, let machine soak as long as possible, then proceed with the following steps.

18. Complete a minimum of two more rinse cycles. DO NOT spray out the rinsate.
19. On the Gen 4 display, navigate to the main run page and ensure the “spray off” pressure is set to 60 psi (4.1 bar).
20. Turn both solution pumps ON.
21. Turn agitation ON and allow to run for approximately 10 minutes, then shut agitation OFF.
22. Spray rinsate out of the boom, cycling the individual boom section shutoff valves at least once through this process.

NOTE: Setting the manual target pressure to 100 psi (6.9 bar) and selecting it will aid in this process.

23. Using the sprayer pump, fill the solution tank full with clean water.
24. Turn the eductor hopper valve ON.
25. Turn the eductor hopper rinse valve ON and allow the eductor to rinse with clean water for approximately 10 minutes.
26. Turn agitation ON and allow to run for approximately 10 minutes.

27. Spray entire contents of solution tank out of the boom.
28. Inspect tank and solution system for chemical discoloration, odor, and buildup of chemical deposits. **If necessary, repeat all of the previous steps.**

If Temperature is Near Freezing:

- Add 27.5 gallons/104.1 L of John Deere winterizer fluid (N305634) (2.5 gal/9.5 L), or (TY26555 (55 gal/208.2 L)) to the solution tank via the eductor.
- Spray a small amount of this fluid out of the nozzles to ensure all solution tubing is filled with winterizer fluid before proceeding to the next step.
- Open the rinse tank fill ball valve and leave open.

NOTE: Be cautious of fluid leaving the rinse tank.

- Remove clamp from the bottom of eductor hopper.

NOTE: Retain clamp and o-ring for re-installation or draw on antifreeze from eductor hopper.

Inspect Hydraulic Hoses - 50 Hours



⚠ CAUTION

Escaping fluid under pressure can penetrate the skin causing serious injury. If an accident occurs, see a doctor immediately. Any fluid injected into the skin must be surgically removed within a few hours or gangrene may result. Doctors unfamiliar with this type of injury should reference a knowledgeable medical source. Such information is available in English from Deere & Company Medical Department in Moline, Illinois, U.S.A., by calling 1-800-822-8262 or +1 309-748-5636.

- Inspect hydraulic hoses every 50 hours for leakage, kinking, cuts, cracks, abrasion, blisters, corrosion, exposed wire braid, or any other signs of wear or damage.
- Replace worn or damaged hose assemblies immediately with Hagie-approved replacement parts.
- Avoid the hazard by relieving pressure before disconnecting hydraulic or other lines. Tighten all connections before applying pressure.
- Search for leaks with a piece of cardboard. Protect hands and body from high-pressure fluids.

Inspect Liquid System and Boom Structure - 200 Hours

Inspect the liquid system and boom structure for straightness, cracked welds, loose hardware, and other defects every 200 hours. Repair as necessary.

Change Hydraulic Oil - 1000 Hours

1. Place booms in boom cradles and retract all hydraulic cylinders, including tread adjust cylinders.
2. Park machine on a flat level surface. Shut off engine and remove key.
3. Remove plug from hydraulic oil drain hose (A) and drain hydraulic oil into a suitable container.

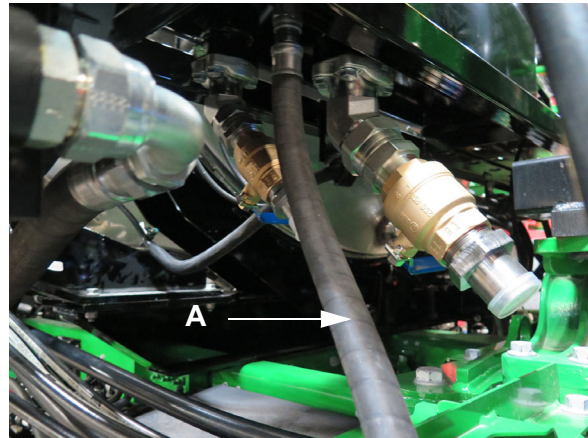

A - Hydraulic Oil Drain Hose

4. Reinstall hose plug.

SECTION 14 – LUBRICATION AND MAINTENANCE



- Using one of the following methods, fill hydraulic oil reservoir with recommended hydraulic oil until oil level in the sight gauge (A) is at the correct level on the decal (B).

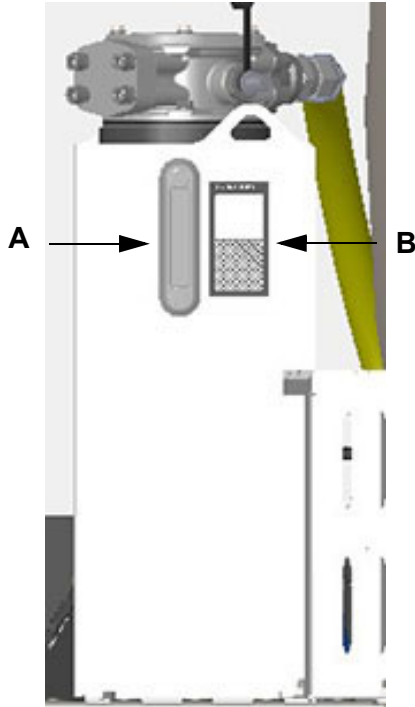

A - Hydraulic Oil Reservoir Sight Gauge
B - Sight Gauge Decal

Filling Hydraulic Oil Reservoir - Method 1 (Fill Through Hydraulic Oil Fill Port, *Preferred Method*)

NOTE: A hydraulic oil pump is required to fill through the hydraulic oil fill port, as gravity will not work and there is a small pressure to be overcome.

- Remove rubber cap from fill port (A).
- Attach hydraulic oil pump quick-connect fitting to the hydraulic oil fill port. Slowly squeeze pump handle and fill reservoir.
- When finished, disconnect quick-connect fitting from fill port and reinstall rubber cap.

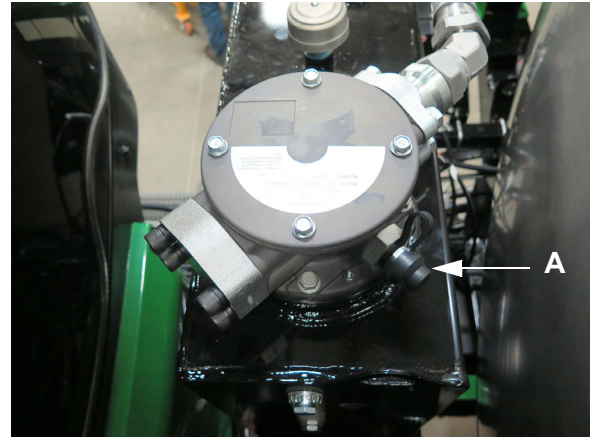

A - Fill Port

Filling Hydraulic Oil Reservoir - Method 2 (Fill Through Hydraulic Return Filter Housing)

NOTE: Clean dirt/debris from return filter housing cover before removing.

- Using a 1/2" wrench, remove the four (4) bolts from the return filter housing cover (B) and set aside.
- Remove cover and fill reservoir.
- When finished, reinstall cover and bolts.

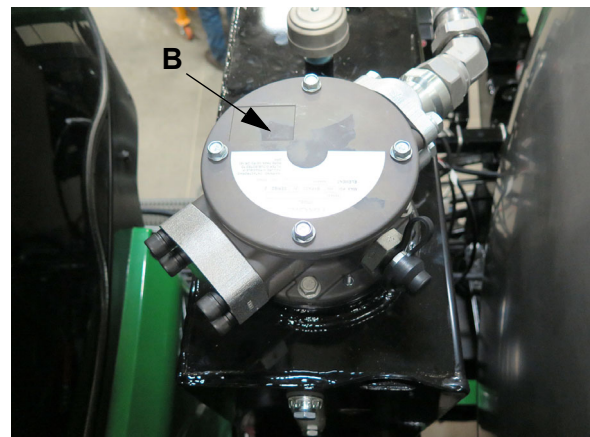

B - Return Filter Housing Cover

Inspect Hydraulic Relief Valves - 1000 Hours

Inspect hydraulic relief valves and relief pressures every 1000 hours. See your John Deere dealer or other qualified service provider for this service.

Inspect Boom Pivot Bushings - Annually

1. Check for loose joints at boom pivots (A).

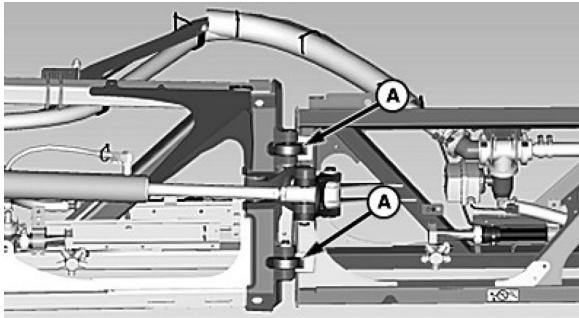

A - Boom Pivot

2. Remove pivot pins and visually check bushings if joints are loose.
3. Replace bushing if it is worn halfway through. See your John Deere dealer or qualified service provider for assistance.

Clean Sprayer and Coat Exposed Surfaces - Annually

Clean sprayer annually (see “Clean Vehicle of Hazardous Chemicals, Including Pesticides” in the Storage section). Treat exposed surfaces with coating TY25396 to prevent rust and corrosion.



SECTION 15 – LUBRICANT SPECIFICATIONS

Transmission and Hydraulic Oil

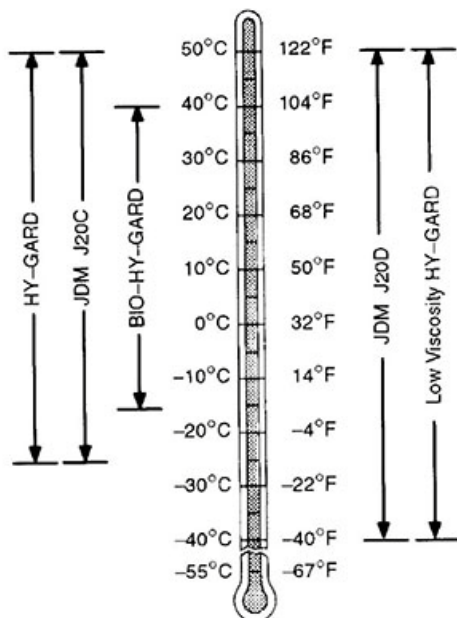

Use oil viscosity based on the expected air temperature range during the period between oil changes.

The following oils are preferred:

- John Deere HY-GARD™
- John Deere Low Viscosity HY-GARD™

John Deere BIO HY-GARD™ oil is recommended. Other oils may be used if they meet one of the following:

- John Deere Standard JDM J20C
- John Deere Standard JDM J20D

Arctic oils (such as military specification MIL-L-46167B) may be used at temperatures below -30°C (-22°F).

HY-GARD is a registered trademark of Deere & Company. BIO HY-GARD is a trademark of Deere & Company.

Multipurpose Extreme Pressure (EP) Grease

IMPORTANT: For automated lubrication systems, different ambient air temperatures need to be considered.

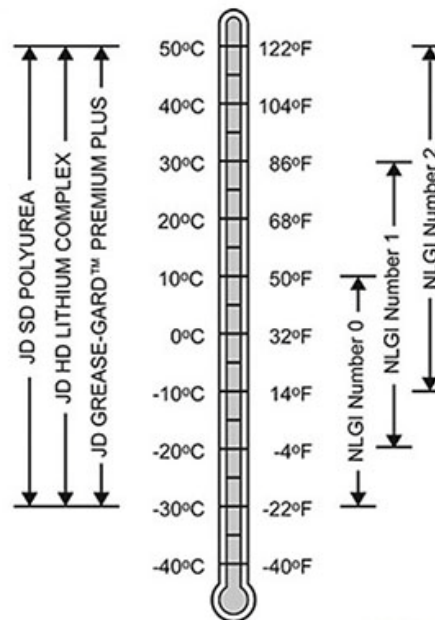

Greases for Air Temperature Ranges

Use grease based on NLGI consistency numbers and the expected air temperature range during the service interval.

John Deere SD Polyurea grease is preferred. The following greases are also recommended:

- John Deere HD Lithium Complex Grease
- John Deere Grease-Gard™ Premium Plus

Other greases may be used if they meet the following:

- NLGI Performance Classification GC-LB
- ISO-L-X-BDHB 2 or DIN KP 2 N-10 Lithium Complex, Non-Synthetic Base Oil (100 to 220 mm²/s @40°C)

IMPORTANT: Some types of thickeners, base oils, and additives used in greases are not compatible with others. Mixing greases

SECTION 15 – LUBRICANT SPECIFICATIONS



should be avoided. Consult your grease supplier before mixing different types of grease.



SECTION 16 – STORAGE

Avoid Exposure to Chemicals



⚠ CAUTION

Exposure to chemicals, including pesticides, can cause injury or death. DO NOT RELY ON CAB, CAB PRESSURE INDICATOR, OR CAB AIR FILTERS TO PROTECT AGAINST CHEMICAL EXPOSURE.

To reduce risk of chemical exposure:

- Wear PERSONAL PROTECTIVE EQUIPMENT in accordance with chemical manufacturer's label
- Allow only trained, certified applicators to apply chemicals
- Always close the windows and doors during application
- Verify that John Deere-activated carbon filters, or appropriate substitutes, are installed at all times (see "Check and

Replace Cab Air Filters" in the Cab and Air Conditioning section of your machine operator's manual)

- Keep chemicals out of the cab
- Clean or remove contaminated shoes or clothing before entering the cab
- Keep cab interior clean

Read and follow all instructions in:

- Manufacturer's label for each chemical applied
- U.S. Environmental Protection Agency (EPA) Worker Protection Standard for Agricultural Pesticides
- State or regional guidelines for worker safety and health
- Operator's Manual for this machine
- Numerous requirements must be met, including but not limited to EPA regulations
- Even while inside cab, always wear long sleeves, long pants, shoes, and socks when applying chemicals, including pesticides
- If necessary to leave cab when chemicals, including pesticides are present, always use personal protective equipment recommended by the chemical manufacturer
- Before reentering the cab, remove personal protective equipment used to handle chemicals, including pesticides, and store equipment in accordance with EPA guidelines to prevent contaminating cab

Service and Operate Chemical Sprayers Safely



Chemicals used in agricultural sprayers can be harmful to your health or the environment if not used carefully. Always follow all label directions for effective, safe, and legal use of agricultural chemicals.

Reduce risk of exposure and injury:

- Wear appropriate personal protective equipment as recommended by the manufacturer, (See “Handle Agricultural Chemicals Safely” in the Safety section of this manual).
- Fill, flush, calibrate, and decontaminate sprayer in an area where runoff will not reach ponds, lakes or streams, livestock areas, gardens, or near other people.
- Keep children away from the chemicals, chemical solutions, and rinsates.
- If spray or chemical concentrate contacts skin, hands, or face, wash immediately with soap and water. If spray or chemical concentrate gets into eyes, flush immediately with water.
- If nozzle clogs or system malfunctions, stop engine and relieve spray pressure from system.
- Do not place nozzle tips or other components to the mouth to clear obstructions. Keep spare tips on hand for replacement.

- Minimize risk of spray drift.
 - Use large nozzle tips operated at lower pressures
 - Do not operate solution delivery system at pressures exceeding 345 kPa (3.5 bar) (50 psi).
 - Do not spray when winds exceed 16 km/h (10 mph)
 - Do not spray when wind is blowing towards a nearby sensitive crop, garden, or populated area.
- Properly dispose of unused chemicals, flushing solution, and empty chemical containers.
- Decontaminate equipment used in mixing, transferring, and applying chemicals after use.

Clean Vehicle of Hazardous Chemicals, Including Pesticides

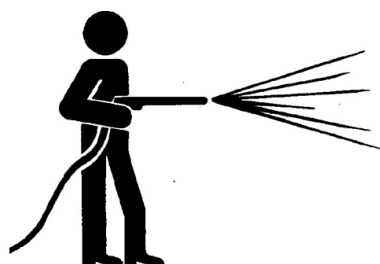

⚠ CAUTION

During application of hazardous chemicals, including pesticides, residue can build up on the inside and outside of the vehicle. Clean vehicle according to use instructions of hazardous chemical.

When exposed to hazardous chemicals, clean exterior and interior of vehicle daily to keep free of the accumulation of visible dirt and contamination.

IMPORTANT: Directing pressurized water at electronic/electrical components or connectors, bearings and hydraulic seals,

fuel injection pumps, or other sensitive parts and components may cause product malfunctions. Reduce pressure and spray at a 45 to 90-degree angle.

1. Wash entire exterior of vehicle.
2. Dispose of any wash water with hazardous concentrations of active or non-active ingredients according to published regulations and directives.

Recommended Cleaners and Coatings

IMPORTANT: As with any chemical product, always read and follow directions on label for use.

Use John Deere SprayMaster™ cleaning agents, equipment coating, and winterizer fluid for best results. These chemicals are available from your John Deere dealer.

- Spray Tank Cleaner N305631
- Winterizer Fluid N305634
- TY25396 Coating

Prepare Machine for Storage

NOTE: Refer to your machine operator's manual for proper procedure to prepare the overall machine for storage.

1. Clean machine thoroughly, inside and out. (See “Clean Vehicle of Hazardous Chemicals, Including Pesticides” in this section).
2. Perform daily level checks, lubrication, and bolt/linkage inspections.
3. Touch up painted surfaces that are scratched or chipped to prevent rust.
4. Winterize the Liquid System. (See your machine operator's manual for further information).

Remove Machine from Storage

1. Clean machine thoroughly, inside and out.
 2. Check oil level in hydraulic reservoir. If low, check for leaks. Add oil as required.
 3. Ensure all hardware is tight.
 4. Lubricate all grease fittings. (See Lubrication and Maintenance section in this manual).
 5. Drain winterizer fluid from the Liquid System and flush system thoroughly.
 6. Add clean water to the solution tank and operate system to check for leaks before installing nozzle tips and screens.
 7. Inspect nozzle tips and ensure they are all the same size. Install tips and screens.
 8. Operate Liquid System and observe spray patterns. Adjust or replace tips as necessary.
 9. Manually cycle all of the boom hydraulic functions two or three times to thoroughly lubricate components. Test the NORAC® system and all of its functions according to the manufacturer's operation manual.
 10. Review operator's manual for operating adjustments and safety information.
 11. Calibrate the Liquid System.
-



SECTION 17 – SPECIFICATIONS

Specifications

⚠ CAUTION

Do not exceed load capacity for the tires used and the maximum allowed homologated mass of the machine configuration.

SPRAY SYSTEM	
Display	John Deere Spray Rate Controller
Boom	90' (27.4 m)
	7 Sections
	1" (2.5 cm) Wet Boom Pipe
	60" (152 cm) Spacing, On-Center, CAM-Locks
	30" (76 cm) Spacing, Off-Center, High-Flow Turrets
Quik-Fill™ Connection	3" (7.6 cm) ID
Solution Tank	Stainless Steel
Solution Pump (2)	Hypro® Centrifugal Hydraulically Driven
	3" (7.6 cm) Inlet/2" (5.1 cm) Outlet Plumbing
Flow Meter (2)	Electromagnetic
	3-210 GPM (11.4-795 l/min)
Boom Solution Valves	Electric Actuation
	Stainless Ball/Stem
Maximum System Pressure	100 psi (6.9 bar)
Spray Hydraulics	LS Pump (power demand to 3000 psi/206.8 bar)
	Gas-Charged Accumulator
	Pressure Sensing Closed Loop Capable
Boom Hydraulics	PC Pump (full-time power to 3000 psi/206.8 bar)

RINSE SYSTEM	
Rinse Tank	Polyethylene
	2 Nozzles (inside tank)

ELECTRICAL SYSTEM	
Controls	Micro Display/Keypad (at exterior Solution Command station for easy fill commands)
Lighting	2 Amber, 2 Taillights
	2 Flood Lights (outward facing)
	1 Beacon Light (optional)

**SECTION 17 –
SPECIFICATIONS**



FLUID CAPACITIES	
Solution Tank	2000 Gallons (7570 L)
Rinse Tank	200 Gallons (757 L)
Hydraulic System (overall)	31.75 Gallons (120 L)
Hydraulic Oil Reservoir	24 Gallons (90 L)
Hand Wash Tank	4 Gallons (15 L)

WEIGHTS (EMPTY)	
Liquid System - Overall	11,300 lbs/5,125 kg
Skid Only	9,460 lbs/4,291 kg
Cart Only	1,840 lbs/834 kg
Machine (skid installed/boom folded)	7,780 lbs/3,528 kg (front left) 7,540 lbs/3,420 kg (front right) 9,920 lbs/4,499 kg (rear left) 9,980 lbs/4,526 kg (rear right) 35,220 lbs/15,975 kg (total)
Machine (skid installed, boom unfolded)	6,320 lbs/2,866 kg (front left) 6,280 lbs/2,848 kg (front right) 11,100 lbs/5,034 kg (rear left) 11,480 lbs/5,207 kg (rear right) 35,180 lbs/15,957 kg (total)
Rear Axle (boom folded)	19,900 lbs/9,026 kg
Rear Axle (boom unfolded)	22,580 lbs/10,242 kg

Dimensions

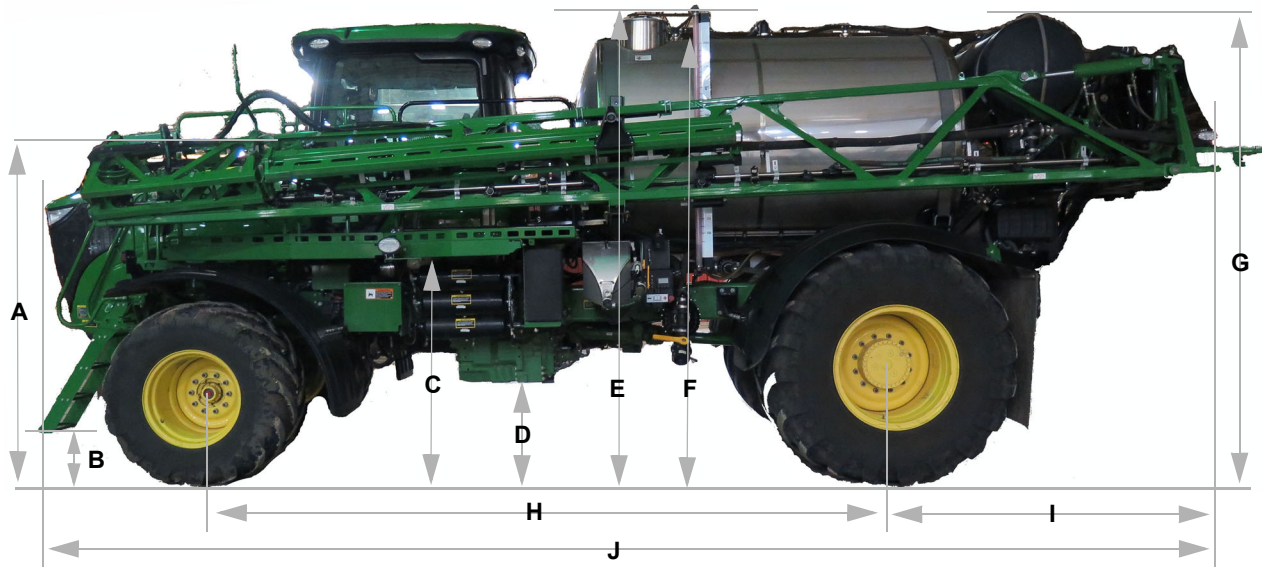

ITEM	DESCRIPTION	MEASUREMENT mm (in)
A	Top of Boom to Ground	99.6" (253 cm)
B	Bottom of Ladder to Ground	11.8" (30 cm)
C	Bottom of Platform to Ground	65.8" (167.1 cm)
D	Bottom of Transmission to Ground	23.2" (58.9 cm)
E	Top of Solution Tank to Ground (fill opening)	142.9" (363 cm)
F	Top of Solution Tank to Ground	133.9" (340.1 cm)
G	Top of Rinse Tank to Ground	139" (353.1 cm)
H	Wheel Base (center of front and rear hubs)	202.4" (514.1 cm)
I	Center of Rear Hub to Rear of Machine	124.4" (316 cm)
J	Overall Length*	394.5" (10 m)

* Overall length of Hagie Liquid System mounted on transport cart is 372" (944.9 cm).

**SECTION 17 –
SPECIFICATIONS**

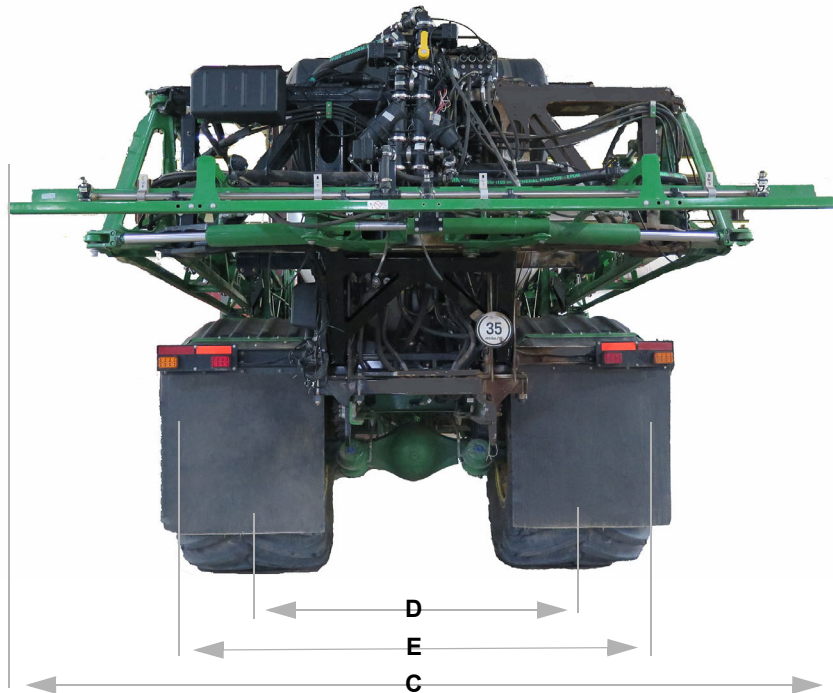
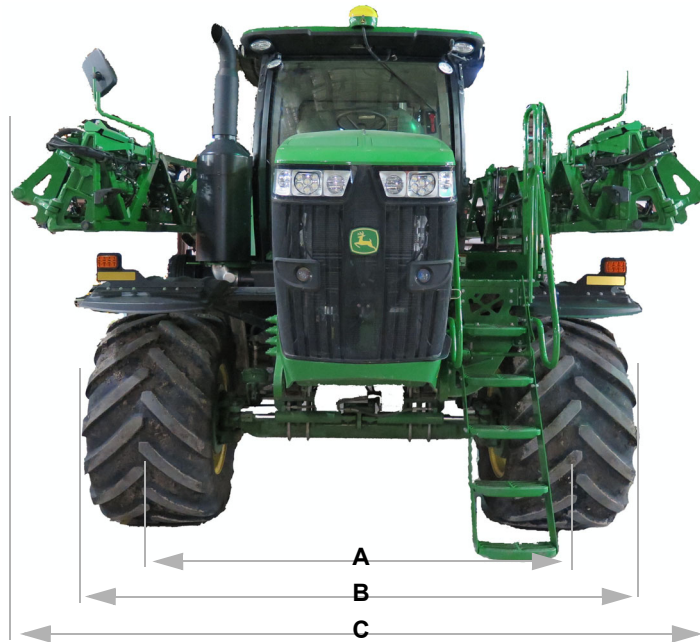

ITEM	DESCRIPTION	MEASUREMENT
A	Front Wheels (center to center)	99.6" (253 cm)
B	Front Wheels (outside to outside)	129.5" (328.9 cm)
C	Overall Width (booms folded)	165.4" (420.1 cm)
D	Rear Wheels (center to center)	93.7" (238 cm)
E	Rear Wheels (outside to outside)	134" (340.4 cm)



ITEM	DESCRIPTION	MEASUREMENT
F	Solution Tank Width	80" (203.2 cm) - with sight gauge 74" (188 cm) - without sight gauge

Unified Inch Bolt and Screw Torque Values

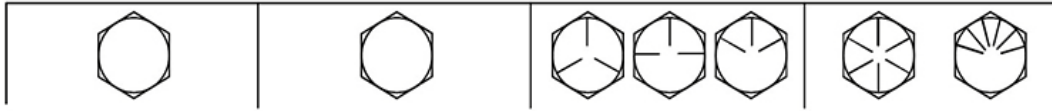

Bolt or Screw Size	SAE Grade 1				SAE Grade 2 ^a				SAE Grade 5, 5.1, or 5.2				SAE Grade 8 or 8.2			
	Lubricated ^b		Dry ^c		Lubricated ^b		Dry ^c		Lubricated ^b		Dry ^c		Lubricated ^b		Dry ^c	
	N-m	lb.-in.	N-m	lb.-in.	N-m	lb.-in.	N-m	lb.-in.	N-m	lb.-in.	N-m	lb.-in.	N-m	lb.-in.	N-m	lb.-in.
1/4	3.7	33	4.7	42	6	53	7.5	66	9.5	84	12	106	13.5	120	17	150
													N-m	lb.-ft.	N-m	lb.-ft.
5/16	7.7	68	9.8	86	12	106	15.5	137	19.5	172	25	221	28	20.5	35	26
									N-m	lb.-ft.	N-m	lb.-ft.				
3/8	13.5	120	17.5	155	22	194	27	240	35	26	44	32.5	49	36	63	46
			N-m	lb.-ft.	N-m	lb.-ft.	N-m	lb.-ft.								
7/16	22	194	28	20.5	35	26	44	32.5	56	41	70	52	80	59	100	74
	N-m	lb.-ft.														
1/2	34	25	42	31	53	39	67	49	85	63	110	80	120	88	155	115
9/16	48	35.5	60	45	76	56	95	70	125	92	155	115	175	130	220	165
5/8	67	49	85	63	105	77	135	100	170	125	215	160	240	175	305	225
3/4	120	88	150	110	190	140	240	175	300	220	380	280	425	315	540	400
7/8	190	140	240	175	190	140	240	175	490	360	615	455	690	510	870	640
1	285	210	360	265	285	210	360	265	730	540	920	680	1030	760	1300	960
1-1/8	400	300	510	375	400	300	510	375	910	670	1150	850	1450	1075	1850	1350
1-1/4	570	420	725	535	570	420	725	535	1280	945	1630	1200	2050	1500	2600	1920
1-3/8	750	550	950	700	750	550	950	700	1700	1250	2140	1580	2700	2000	3400	2500
1-1/2	990	730	1250	930	990	730	1250	930	2250	1650	2850	2100	3600	2650	4550	3350

Torque values listed are for general use only, based on the strength of the bolt or screw. DO NOT use these values if a different torque value or tightening procedure is given for a specific application. For plastic insert or crimped steel-type lock nuts, for stainless steel fasteners, or for nuts on U-bolts, see the tightening instructions for the specific application. Shear bolts are designed to fail under predetermined loads. Always replace shear bolts with identical grade.

Replace fasteners with the same or higher grade. If higher grade fasteners are used, tighten these to the strength of the original. Make sure fastener threads are clean and that you properly start thread engagement. When possible, lubricate plain or zinc plated fasteners other than lock nuts, wheel bolts or wheel nuts, unless different instructions are given for the specific application.

^aGrade 2 applies for hex cap screws (not hex bolts) up to 6 in. (152 mm) long. Grade 1 applies for hex cap screws over 6 in. (152 mm) long, and for all other types of bolts and screws of any length.

^b“Lubricated” means coated with a lubricant such as engine oil, fasteners with phosphate and oil coatings, or 7/8 in. and larger fasteners with JDM F13C, F13F or F13J zinc flake coating.

^c“Dry” means plain or zinc plated without any lubrication, or 1/4 to 3/4 in. fasteners with JDM F13B, F13E or F13H zinc flake coating.

Metric Bolt and Screw Torque Values

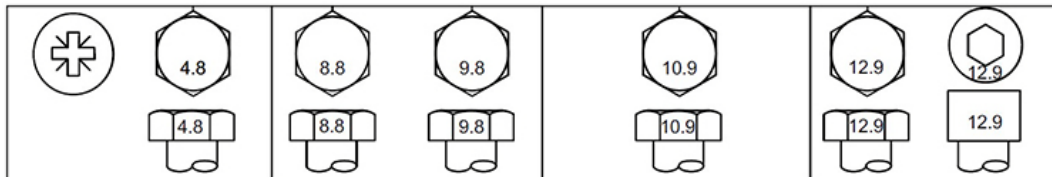

Bolt or Screw Size	Class 4.8				Class 8.8 or 9.8				Class 10.9				Class 12.9			
	Lubricated ^a		Dry ^b		Lubricated ^a		Dry ^b		Lubricated ^a		Dry ^b		Lubricated ^a		Dry ^b	
	N-m	lb.-in.	N-m	lb.-in.	N-m	lb.-in.	N-m	lb.-in.	N-m	lb.-in.	N-m	lb.-in.	N-m	lb.-in.	N-m	lb.-in.
M6	4.7	42	6	53	8.9	79	11.3	100	13	115	16.5	146	15.5	137	19.5	172
									N-m	lb.-ft.	N-m	lb.-ft.	N-m	lb.-ft.	N-m	lb.-ft.
M8	11.5	102	14.5	128	22	194	27.5	243	32	23.5	40	29.5	37	27.5	47	35
			N-m	lb.-ft.	N-m	lb.-ft.	N-m	lb.-ft.								
M10	23	204	29	21	43	32	55	40	63	46	80	59	75	55	95	70
	N-m	lb.-ft.														
M12	40	29.5	50	37	75	55	95	70	110	80	140	105	130	95	165	120
M14	63	46	80	59	120	88	150	110	175	130	220	165	205	150	260	190
M16	100	74	125	92	190	140	240	175	275	200	350	255	320	235	400	300
M18	135	100	170	125	265	195	330	245	375	275	475	350	440	325	560	410
M20	190	140	245	180	375	275	475	350	530	390	675	500	625	460	790	580
M22	265	195	330	245	510	375	650	480	725	535	920	680	850	625	1080	800
M24	330	245	425	315	650	480	820	600	920	680	1150	850	1080	800	1350	1000
M27	490	360	625	460	950	700	1200	885	1350	1000	1700	1250	1580	1160	2000	1475
M30	660	490	850	625	1290	950	1630	1200	1850	1350	2300	1700	2140	1580	2700	2000
M33	900	665	1150	850	1750	1300	2200	1625	2500	1850	3150	2325	2900	2150	3700	2730
M36	1150	850	1450	1075	2250	1650	2850	2100	3200	2350	4050	3000	3750	2770	4750	3500

Torque values listed are for general use only, based on the strength of the bolt or screw. DO NOT use these values if a different torque value or tightening procedure is given for a specific application. For stainless steel fasteners or for nuts on U-bolts, see the tightening instructions for the specific application. Tighten plastic insert or crimped steel-type lock nuts by turning the nut to the dry torque shown in the chart, unless different instructions are given for the specific application.

Shear bolts are designed to fail under predetermined loads. Always replace shear bolts with identical property class. Replace fasteners with the same or higher property class. If higher property class fasteners are used, tighten these to the strength of the original. Make sure fastener threads are clean and that you properly start thread engagement. When possible, lubricate plain or zinc plated fasteners other than lock nuts, wheel bolts or wheel nuts, unless different instructions are given for the specific application.

^a“Lubricated” means coated with a lubricant such as engine oil, fasteners with phosphate and oil coatings, or M20 and larger fasteners with JDM F13C, F13F or F13J zinc flake coating.

^b“Dry” means plain or zinc plated without any lubrication, or M6 to M18 fasteners with JDM F13B, F13E or F13H zinc flake coating.

Face Seal Fittings Assembly and Installation - All Pressure Applications

Face Seal O-Ring to Stud End Installation

1. Inspect the fitting surfaces. They must be free of dirt and/or defects.
2. Inspect the O-ring. It must be free of damage and/or defects.
3. Lubricate O-rings using system oil, and install into groove.
4. Push O-ring into groove so O-ring is not displaced during assembly.
5. Index angle fittings and tighten by hand pressing joint together to insure O-ring remains in place.
6. Tighten fitting or nut to torque value shown on the chart per dash size stamped on the fitting. DO NOT allow hoses to twist when tightening fittings.

Face Seal Adjustable Stud End O-Ring Installation

1. Back off lock nut (jam nut) and washer to full exposed turned down section of the fitting.

2. Install a thimble over the fitting threads to protect the O-ring from nicks.
3. Slide the O-ring over the thimble into the turned down section of the fitting.
4. Remove thimble.

Face Seal Straight Stud End O-Ring Installation

1. Install a thimble over the fitting threads to protect the O-ring from nicks.
2. Slide the O-ring over the thimble into the turned down section of the fitting.
3. Remove thimble.

Fitting Installation

1. Install fitting by hand until snug.
2. Position adjustable fittings by unscrewing the fitting no more than one turn.
3. Apply assembly torque per table.

Assembly Torque

1. Use one wrench to hold the connector body and one wrench to tighten nut.
2. For a hydraulic hose, it may be necessary to use three wrenches to prevent twist; one on the connector body, one on the nut, and one on the body of the hose fitting.

Metric Face Seal and O-Ring Stud End Fitting Torque Values
Standard Pressure Applications

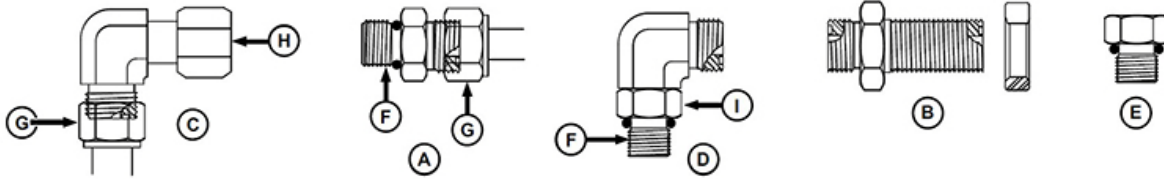

- A - Stud Straight and Tube Nut
- B - Bulkhead Union and Bulkhead Lock Nut
- C - 90° Swivel Elbow and Tube Nut
- D - 90° Adjustable Stud Elbow
- E - Port Plug
- F - Stud End
- G - Tube Nut
- H - Swivel Nut
- I - Lock Nut

Metric Face Seal and O-Ring Stud End Fitting Torque Chart - Standard Pressure (Below 27.6 MPA/4,000 PSI)

Nominal Tube OD Hose ID		O-Ring Face Seal/ Tube Swivel Nut						Bulkhead Jam Nut Torque ^A			O-Ring Straight, Adjustable, and External Port Plug Stud Ends ^A						
Metric Tube OD	Inch Tube OD			Thread Size	Swivel Nut Hex Size	Tube Nut/ Swivel Nut Torque		Jam Nut Hex Size	Jam Nut Torque		Thread Size	Straight Hex Size ^B	Adj Lock Nut Hex Size	Steel or Gray Iron Torque		Aluminum or Brass Torque ^C	
mm	Dash Size	in.	mm	in.	mm	N·m	lb.-ft.	mm	N·m	lb.-ft.	mm	mm	mm	N·m	lb.-ft.		
N·m	lb.-ft.																
4	-2	0.1 -25	3.18	---	---	---	---	---	---	---	M8x1	12	12	8	6	5	4
5	-3	0.1 -88	4.76	---	---	---	---	---	---	---	M10x1	14	14	15	11	10	7
6	-4	0.2 -50	6.35	9/16- 18	17	24	18	22	32	24	M12x1.5	17	17	25	18	17	12
8	-5	0.3 -12	7.92	---	---	---	---	---	---	---	M14x1.5	19	19	40	30	27	20
10	-6	0.3 -75	9.53	11/16- 16	22	37	27	27	42	31	M16x1.5	22	22	45	33	30	22
12	-8	0.5 -00	12.7- 0	13/16- 16	24	50	37	30	93	69	M18x1.5	24	24	50	37	33	25

SECTION 17 – SPECIFICATIONS



16	-10	0.6 -25	15.8- 8	1-14	30	69	51	36	118	87	M22x1.5	27	27	69	51	46	34
20	-12	0.7 -50	19.0- 5	1-3/16- 12	36	102	75	41	175	129	M27x2	32	32	10- 0	74	67	49
22	-14	0.8 -75	22.2- 3	1-3/16- 12	36	102	75	41	175	129	M30x2	36	36	13- 0	96	87	64
25	-16	1.0 -00	25.4- 0	1-7/16- 12	41	142	105	46	247	182	M33x2	41	41	16- 0	118	1- 07	79
28	---	---	---	---	---	---	---	---	---	---	M38x2	46	46	17- 6	130	1- 17	87
32	-20	1.2 -50	31.7- 5	1-11/ 16-12	50	190	140	50	328	242	M42x2	50	50	21- 0	155	1- 40	1- 03
38	-24	1.5 -00	38.1- 0	2-12	60	217	160	60	374	276	M48x2	55	55	26- 0	192	1- 73	1- 28
50	-32	2.0 -00	50.8- 0	---	---	---	---	---	---	---	M60x2	65	65	31- 5	232	2- 10	1- 55

A Tolerance is +15%, minus 20% of mean tightening torque unless otherwise specified.

B The straight hex wrench sizes listed apply to connectors only and may not be the same as the corresponding plug of the same thread size.

C These torques were established using steel plated connectors in aluminum and brass.

Metric Face Seal and O-Ring Stud End Fitting Torque Values

High Pressure Applications

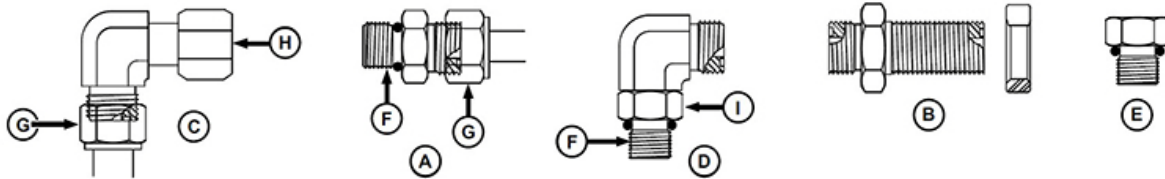

- A - Stud Straight and Tube Nut
- B - Bulkhead Union and Bulkhead Lock Nut
- C - 90° Swivel Elbow and Tube Nut
- D - 90° Adjustable Stud Elbow
- E - Port Plug
- F - Stud End
- G - Tube Nut
- H - Swivel Nut
- I - Lock Nut



SECTION 17 – SPECIFICATIONS

Metric Face Seal and O-Ring Stud End Fitting Torque Chart High Pressure (Above 27.6 MPA/4,000 PSI), Working Pressure (41.3 MPA/6,000 PSI)															
Nominal Tube OD Hose ID				O-Ring Face Seal/ Tube Swivel Nut				Bulkhead Jam Nut Torque ^A			O-Ring Straight, Adjustable, and External Port Plug Stud Ends ^A				
Metric Tube OD	Inch Tube OD			Thread Size	Swivel Nut Hex Size	Tube Nut/ Swivel Nut Torque		Jam Nut Hex Size	Jam Nut Torque		Thread Size	Straight Hex Size ^B	Adj Lock Nut Hex Size	Steel or Gray Iron Torque	
	mm	Dash Size	in.			mm	in.		mm	N-m				lb.-ft.	mm
4	-2	0.12-5	3.18	---	---	---	---	---	---	---	M8x1	12	12	8	6
5	-3	0.18-8	4.76	---	---	---	---	---	---	---	M10x1	14	14	15	11
6	-4	0.25-0	6.35	9/16-18	17	24	18	22	32	24	M12x1.5	17	17	35	26
8	-5	0.31-2	7.92	---	---	---	---	---	---	---	M14x1.5	19	19	45	33
10	-6	0.37-5	9.53	11/16-16	22	37	27	27	42	31	M16x1.5	22	22	55	41
12	-8	0.50-0	12.70	13/16-16	24	63	46	30	93	69	M18x1.5	24	24	70	52
16	-10	0.62-5	15.88	1-14	30	103	76	36	118	87	M22x1.5	27	27	100	74
20	-12	0.75-0	19.05	1-3/16-12	36	152	112	41	175	129	M27x2	32	32	170	125
22	-14	0.87-5	22.23	1-3/16-12	36	152	112	41	175	129	M30x2	36	36	215	159
25	-16	1.00-0	25.40	1-7/16-12	41	214	158	46	247	182	M33x2	41	41	260	192
28	---	---	---	---	---	---	---	---	---	---	M38x2	46	46	320	236
32	-20	1.25-0	31.75	1-11/16-12	50	286	211	50	328	242	M42x2	50	50	360	266
38	-24	1.50-0	38.10	2-12	60	326	240	60	374	276	M48x2	55	55	420	310

^ATolerance is +15%, minus 20% of mean tightening torque unless otherwise specified.

^BThe straight hex wrench sizes listed apply to connectors only and may not be the same as the corresponding plug of the same thread size.

SECTION 17 – SPECIFICATIONS



SAE Face Seal and O-Ring Stud End Fitting Torque Values Standard Pressure Applications

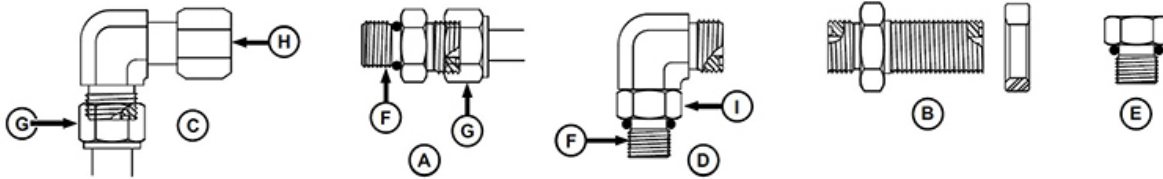

- A - Stud Straight and Tube Nut
- B - Bulkhead Union and Bulkhead Lock Nut
- C - 90° Swivel Elbow and Tube Nut
- D - 90° Adjustable Stud Elbow
- E - Port Plug
- F - Stud End
- G - Tube Nut
- H - Swivel Nut
- I - Lock Nut

SAE Face Seal and O-Ring Stud End Fitting Torque Chart - Standard Pressure (Below 27.6 MPA/4,000 PSI)

Nominal Tube OD Hose ID		O-Ring Face Seal/ Tube Swivel Nut			Bulkhead Jam Nut Torque ^A			O-Ring Straight, Adjustable, and External Port Plug Stud Ends ^A									
Metric Tube OD	Inch Tube OD			Thread Size	Swivel Nut Hex Size	Tube Nut/ Swivel Nut Torque		Jam Nut Hex Size	Jam Nut Torque	Thread Size	Straight Hex Size ^B	Adj Lock Nut Hex Size	Steel or Gray Iron Torque		Aluminum or Brass Torque ^C		
mm	Dash Size	in.	mm	in.	in.		N-m	lb.-ft.			N-m	lb.-ft.	in.	in.	in.		
N-m	lb.-ft.	N-m	lb.-ft.														
5	-3	0.188	4.78	---	---	---	---	---	---	---	3/8-24	5/8	9/16	12	9	8	6
6	-4	0.250	6.35	9/16-18	11/16	24	18	13/16	32	24	7/16-20	5/8	5/8	16	1-2	11	8
8	-5	0.312	7.92	---	---	---	---	---	---	---	1/2-20	3/4	11/16	24	1-8	16	1-2
10	-6	0.375	9.53	11/16-16	13/16	37	27	1	42	31	9/16-18	3/4	3/4	37	2-7	25	1-8
12	-8	0.500	12.70	13/16-16	15/16	50	37	1-1/8	93	69	3/4-16	7/8	15/16	50	3-7	33	2-5
16	-10	0.625	15.88	1-14	1-1/8	69	51	1-5/16	1-18	87	7/8-14	1-1/16	1-1/16	69	5-1	46	3-4
20	-12	0.750	19.05	1-3/16-12	1-3/8	1-02	75	1-1/2	1-75	1-29	1-1/16-12	1-1/4	1-3/8	10-2	7-5	68	5-0
22	-14	0.875	22.23	1-3/16-12	---	1-02	75	---	1-75	1-29	1-3/16-12	1-3/8	1-1/2	12-2	9-0	81	6-0
25	-16	1.000	25.40	1-7/16-12	1-5/8	1-42	10-5	1-3/4	2-47	1-82	1-5/16-12	1-1/2	1-5/8	14-2	1-0-5	95	7-0
32	-20	1.25	31.75	1-11/16-12	1-7/8	1-90	14-0	2	3-28	2-42	1-5/8-12	1-3/4	1-7/8	19-0	1-4-0	1-27	9-3
38	-24	1.50	38.10	2-12	2-1/4	2-17	16-0	2-3/8	3-74	2-76	1-7/8-12	2-1/8	2-1/8	21-7	1-6-0	1-45	1-0-7
50.8	-32	2.000	50.80	---	---	---	---	---	---	---	2-1/2-12	2-3/4	2-3/4	31-1	2-2-9	2-07	1-5-3

^ATolerance is +15%, minus 20% of mean tightening torque unless otherwise specified.

^BThe straight hex wrench sizes listed apply to connectors only and may not be the same as the corresponding plug of the same thread size.

^CThese torques were established using steel plated connectors in aluminum and brass.

SAE Face Seal and O-Ring Stud End Fitting Torque Values

High Pressure Applications

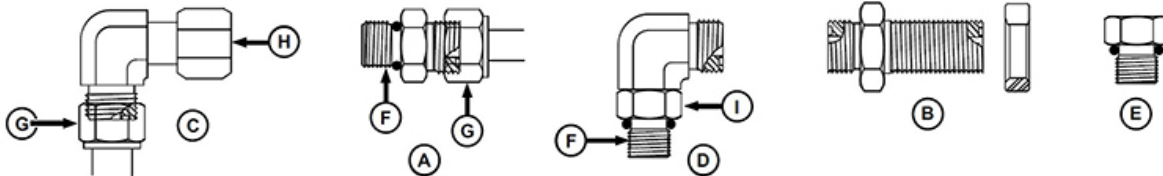

- A - Stud Straight and Tube Nut
- B - Bulkhead Union and Bulkhead Lock Nut
- C - 90° Swivel Elbow and Tube Nut
- D - 90° Adjustable Stud Elbow
- E - Port Plug
- F - Stud End
- G - Tube Nut
- H - Swivel Nut
- I - Lock Nut

SAE Face Seal and O-Ring Stud End Fitting Torque Chart High Pressure (Above 27.6 MPA/4,000 PSI), Working Pressure (41.3 MPA/6,000 PSI)															
Nominal Tube OD Hose ID				O-Ring Face Seal/ Tube Swivel Nut				Bulkhead Jam Nut Torque ^A			O-Ring Straight, Adjustable, and External Port Plug Stud Ends ^A				
Metric Tube OD	Inch Tube OD			Thread Size	Swivel Nut Hex Size	Tube Nut/ Swivel Nut Torque		Jam Nut Hex Size	Jam Nut Torque		Thread Size	Straight Hex Size ^B	Adj Lock Nut Hex Size	Steel or Gray Iron Torque	
	mm	Dash Size	in.			mm	in.		N-m	lb.-ft.				N-m	lb.-ft.
5	-3	0.18-8	4.78	---	---	---	---	---	---	---	3/8-24	5/8	9/16	18	13
6	-4	0.25-0	6.35	9/16-18	11/16	24	18	13/16	32	24	7/16-20	5/8	5/8	24	18
8	-5	0.31-2	7.92	---	---	---	---	---	---	---	1/2-20	3/4	11/16	30	22
10	-6	0.37-5	9.53	11/16-16	13/16	37	27	1	42	31	9/16-18	3/4	3/4	37	27
12	-8	0.50-0	12.70	13/16-16	15/16	63	46	1-1/8	93	69	3/4-16	7/8	15/16	75	55
16	-10	0.62-5	15.88	1-14	1-1/8	103	76	1-5/16	118	87	7/8-14	1-1/16	1-1/16	103	76
20	-12	0.75-0	19.05	1-3/16-12	1-3/8	152	112	1-1/2	175	129	1-1/16-12	1-1/4	1-3/8	177	131
22	-14	0.87-5	22.23	1-3/16-12	---	152	112	---	175	129	1-3/16-12	1-3/8	1-1/2	231	170
25	-16	1.00-0	25.40	1-7/16-12	1-5/8	214	158	1-3/4	247	182	1-5/16-12	1-1/2	1-5/8	270	199
32	-20	1.25	31.75	1-11/16-12	1-7/8	286	211	2	328	242	1-5/8-12	1-3/4	1-7/8	286	211
38	-24	1.50	38.10	2-12	2-1/4	326	240	2-3/8	374	276	1-7/8-12	2-1/8	2-1/8	326	240

^ATolerance is +15%, minus 20% of mean tightening torque unless otherwise specified.

^BThe straight hex wrench sizes listed apply to connectors only and may not be the same as the corresponding plug of the same thread size.

**Four Bolt Flange Fittings
Assembly and Installation - All
Pressure Applications**

1. Inspect the sealing surfaces for nicks or scratches, roughness or out-of-flat condition. Scratches cause leaks. Roughness causes seal wear. Out-of-flat causes seal extrusion. If these defects cannot be polished out, replace the component.
2. Install the correct O-ring (and backup washer if required) into the groove using petroleum jelly to hold it in place.
3. For split flange; loosely assemble split flange halves, being sure that the split is centrally located and perpendicular to the port. Hand-tighten cap screws to hold parts in place. Do not pinch O-ring.
4. For single piece flange; put hydraulic line in the center of the flange and install four cap screws. With the flange centrally located on the port, hand-tighten cap screws to hold it in place. Do not pinch O-ring.
5. For both single piece flange and split flange, be sure the components are properly positioned and cap screws are hand tight. Tighten one cap screw, then tighten the diagonally opposite cap screw. Tighten the two remaining cap screws. Tighten all cap screws within the specified limits shown in the chart. **DO NOT** use air wrenches. **DO NOT** tighten one cap screw fully before tightening the others. **DO NOT** over-tighten.

SAE Four Bolt Flange Cap Screw Torque Values

Standard Pressure Applications

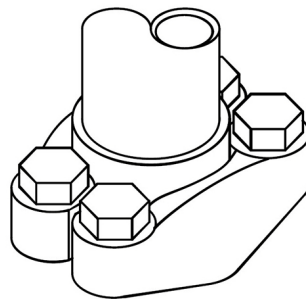

SAE Four Bolt Flange Cap Screw Torque Values - 27,600 KPA (4,000 PSI) Pressure Applications					
		Torque			
		Newton Meters		Foot Pounds	
Nominal Flange Size	Screw Size ^{ab}	Min	Max	Min	Max
1/2	5/16-18 UNC	20	31	15	23
3/4	3/8-16 UNC	28	54	21	40
1	3/8-16 UNC	37	54	27	40

1-1/4	7/16-14 UNC	47	85	35	63
1-1/2	1/2-13 UNC	62	131	46	97
2	1/2-13 UNC	73	131	54	97
2-1/2	1/2-13 UNC	107	131	79	97
3	5/8-11 UNC	187	264	138	195
3-1/2	5/8-11 UNC	158	264	117	195
4	5/8-11 UNC	158	264	117	195
5	5/8-11 UNC	158	264	117	195

^aJDM A17D, SAE Grade 5 or better cap screws with plated hardware.

^b1.5.1.2 Lock washers are permissible but not recommended.

SAE Four Bolt Flange Cap Screw Torque Values

High Pressure Applications

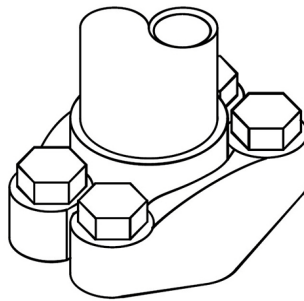

SAE Four Bolt Flange Cap Screw Torque Values - 41,400 KPA (6,000 PSI) Pressure Applications					
		Torque			
		Newton Meters		Foot Pounds	
Nominal Flange Size	Screw Size ^{ab}	Min	Max	Min	Max
1/2	5/16-18 UNC	20	31	15	23
3/4	3/8-16 UNC	34	54	25	40
1	7/16-14 UNC	57	85	42	63
1-1/4	1/2-13 UNC	85	131	63	63
1-1/2	5/8-11 UNC	159	264	117	195
2	3/4-10 UNC	271	468	200	345

^aJDM A17D, SAE Grade 5 or better cap screws with plated hardware.

^b1.5.1.2 Lock washers are permissible but not recommended.

External Hexagon Port Plug Torque Values

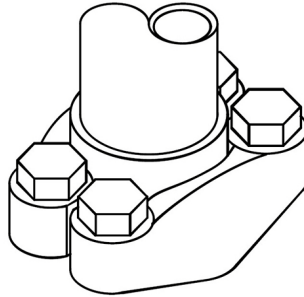

Port or Stud End Thread Size ^a	Torque (+15%/-20%)
M8 x 1	10 N·m (89 lb.-in.)
M10 x 1	17 N·m (150 lb.-in.)
M12 x 1.5	28 N·m (20.6 lb.-in.)
M14 x 1.5	39 N·m (28.7 lb.-in.)
M16 x 1.5	48 N·m (35.4 lb.-in.)
M18 x 1.5	60 N·m (44.2 lb.-in.)
M20 x 1.5	60 N·m (44.2 lb.-in.)
M22 x 1.5	85 N·m (62.7 lb.-in.)
M27 x 2	135 N·m (99.6 lb.-in.)
M30 x 2	165 N·m (121.7 lb.-in.)
M33 x 2	235 N·m (173.3 lb.-in.)
M38 x 2	245 N·m (180.7 lb.-in.)
M42 x 2	260 N·m (191.8 lb.-in.)
M48 x 2	290 N·m (213.9 lb.-in.)
M60 x 2	330 N·m (243.4 lb.-in.)

^aPort to JDS-G173.1; stud end to JDS-G173.3.



27.4 M (90 ft) Boom Flow	
Characteristics - Application	
Rate vs. Speed	11-28
Access Boom and Nozzles	5-1
Access Calibrations and Procedures	6-1
Access Liquid Application System	8-1
Access Rinse System	7-1
Access Tank System	9-1
Adjust Breakaway Section Springs	12-5
Adjust Breakaway Stop	12-6
Adjust Inner Fold Cylinder	12-8
Adjust Outer Boom Section Stop Bolt .	12-6
Adjust Outer Fold Cylinder	12-6
Adjust Outer Wing Rest	12-9
Advanced Settings	8-9
After-Sale	1-3
Agitation	11-8
Agitation	9-5
Agitation of Solution Tank Contents ..	11-19
Avoid Backover Accidents	2-7
Avoid Contact with Chemicals,	
Including Pesticides	11-2
Avoid Exposure to Chemicals	10-1
Avoid Exposure to Chemicals	11-1
Avoid Exposure to Chemicals	16-1
Avoid Exposure to Chemicals	2-12
Avoid Heating Near Pressurized Fluid	
Lines	2-3
Avoid High-Pressure Fluids	2-4
Avoid Injury From Dispensed Objects ...	2-8
Before Operating	2-8
Boom and Nozzles Main Page	5-1
Boom Calibration Auto Boom Fold/ Unfold	6-6
Boom Calibration Center Frame	
Position	6-9
Boom Calibration Level Position	6-10
Boom Calibration Tilt Sensors	6-11
Boom Calibration Tilt Valves	6-13
Boom Maintenance Mode	6-2
Boom Sections Custom	5-3
Boom Spray Width	11-29
Boom Supply Air Bleed	11-34
Boom Unfold/Fold - 27.4 m (90 ft)	
Booms	12-1
Calibration Procedure	11-29
Calibrations and Procedures Overview .	6-1
Change Hydraulic Oil - 1000 Hours	14-9
Charge Port Decal	3-2
Check and Replace Worn Nozzles	11-28
Check Hydraulic Oil Level - Daily	14-3
Check Solution Tank Straps - As Required	14-7
Chemical Eductor - Rinsing Empty	
Containers	11-10
Chemical Eductor	11-8
Chemical Eductor Rinse	11-11
Chemical Exposure Decal	3-1
Chemical Hazard Decal	3-2
Clean Aspirators, Nozzle Bodies, and Tips - As Required	14-6
Clean Oil Cooler - Daily	14-3
Clean Solution Strainers - Daily	14-4
Clean Sprayer and Coat Exposed Surfaces - Annually	14-11
Clean SprayMaster™ 5-Position Nozzle Bodies - Standard Flow	11-32
Clean Vehicle of Hazardous Chemicals, Including Pesticides	14-1
Clean Vehicle of Hazardous Chemicals, Including Pesticides	16-2
Clean Vehicle of Hazardous Chemicals, Including Pesticides	2-13
Conversion Factors (Calibrating For Carriers Other Than Water)	11-30
Current Tank Volume	9-3
Decommissioning - Proper Recycling and Disposal of Fluids and Components ..	2-4
Delivery	1-2
Dimensions	17-3
Dispose of Waste Properly	14-1
Do Not Enter Solution Tank Decal	3-2
Do Not Pressure Wash Decal	3-3
Eductor Level	9-6

Electric Boom Section Valves	11-12	Maintain a Safe Area Around the	
Electrical Power Lines Decal	3-2	Machine	2-7
Eliminating Air from Solution System	11-33	Metric Bolt and Screw Torque Values	.17-7
Emergency Exit	2-13	Metric Face Seal and O-Ring Stud	
External Hexagon Port Plug Torque		End Fitting Torque Values	17-10
Values	17-16	Metric Face Seal and O-Ring Stud	
Face Seal Fittings Assembly and		End Fitting Torque Values	17-9
Installation - All Pressure		Minimum Pressure	8-3
Applications	17-8	Multipurpose Extreme Pressure (EP)	
Field Operation	10-3	Grease	15-1
Flat Fan High-Flow (Flood) Spray Tip	11-26	Non-Permissible Use	2-13
Flat Fan Spray Tip	11-25	NORAC®	5-6
Flow Rate Mode	8-5	Nozzle Calibration	11-29
Flow Recommendations	8-6	Nozzle Flow Check	6-3
Follow Safety Instructions	2-1	Nozzle Setup	5-5
Foreword	1-1	Nozzle Spacing Layout - 60”(152.4 cm) /	
Four Bolt Flange Fittings Assembly and		30”(76.2 cm)	5-14
Installation - All Pressure		Operate Indexed Boom Sections (IBS)	10-5
Applications	17-14	Operate Safely	2-8
Full Boom Breakaway	12-5	Owner Register	1-3
Hand Wash Tank	11-12	Park Machine Safely	2-3
Hand Wash Tank Decal	3-1	Practice Safe Maintenance	2-2
Handle Agricultural Chemicals Safely	.2-11	Pre-Delivery	1-2
Handle Batteries Safely	2-6	Prepare For Emergencies	2-2
Handle Chemical Products Safely	2-5	Prepare for Field Operation	10-2
Handle Fuel Safely - Avoid Fires	2-11	Prepare Machine for Storage	16-3
High-Pressure Washer	11-21	Pressure and Flow Measurement11-11
Hydraulic Oil Under Pressure Decal3-2	Pressure Relief	8-8
Inspect Boom Pivot Bushings -		Prevent Hydraulic System	
Annually	14-11	Contamination	14-1
Inspect Hydraulic Hoses - 50 Hours14-8	Prevent Machine Runaway	2-10
Inspect Hydraulic Relief Valves -		Protect Against Noise	2-2
1000 Hours	14-11	Recognize Safety Information	2-1
Inspect Liquid System and Boom		Recommended Cleaners and Coatings	16-3
Structure - 200 Hours	14-9	Re-Engage NORAC® Through	
Install and Position Nozzle Tips and		Multi-Function Lever	5-9
Strainers	11-30	Remove Machine from Storage	16-3
Instructional Seat	2-9	Remove Paint Before Welding or	
Keep Riders off Machine	2-9	Heating	2-3
Liquid Level Indicator (Solution Tank)	.11-7	Replace Nozzles	11-24
Liquid System Removal and		Replace Safety Signs	3-1
Installation	13-1	Reset Calibrations Boom Calibrations	6-15
Low Tank Alarm	9-4	Reset Calibrations Spray Calibrations	6-19
Lubricate Boom Lift Arm Pins - Daily	...14-4	Rinse System - System Rinse/Boom	
		Rinse	11-19

Rinse System (Boom Only)	7-2	Spray Calibration Flow Meters	6-15
Rinse System (Rinse Tank Transfer)	7-8	Spray Calibration Pressure Sensors .	6-16
Rinse System (Solution System)	7-4	Spray Calibration Solution Pumps	6-18
Rinse System (Solution Tank Only)	7-6	Spray Off Pressure	8-7
Rinse System Main Page	7-1	Spray Pipe Aspirators	11-34
Rinse Tank Decal	3-1	Spray System Main Page	8-1
Rinse Tank Draining	11-18	Spray Tip Types	11-24
Rinse Tank Filling	11-16	Spray with Boom at 18.3 m (60 ft)	12-5
Rinse Water Tank	11-13	Standard Factory Equipment	11-31
SAE Face Seal and O-Ring Stud End		Straight Stream Ceramic Spray Tip ...	11-25
Fitting Torque Values	17-12	Tank Fill Preset	9-3
SAE Face Seal and O-Ring Stud End		Tank System Main Page	9-1
Fitting Torque Values	17-13	Target Fill	9-4
SAE Four Bolt Flange Cap Screw		Target Rate/Rx	8-4
Torque Values	17-14	Transmission and Hydraulic Oil	15-1
SAE Four Bolt Flange Cap Screw		Transport and Operate Safely	2-10
Torque Values	17-15	Transport Decal	3-3
Section Setup	5-13	Troubleshooting	11-23
Service and Assistance	1-3	Troubleshooting Nozzles that Drip, Leak, or Seep After Valve is Shut Off	11-34
Service and Operate Chemical Sprayers		Understand Signal Words	2-1
Safely	10-1	Unified Inch Bolt and Screw Torque	
Service and Operate Chemical Sprayers		Values	17-6
Safely	11-1	Use Caution on Hillsides	2-10
Service and Operate Chemical Sprayers		Use Compressed Air For Cleaning	2-7
Safely	16-2	Use Proper Tools	2-5
Service Application Equipment Safely ...	2-5	Use Safety Lights and Devices	2-9
Service Drive Belts Safely	2-7	Use Seat Belt Properly	2-10
Service Intervals	14-2	Use Spray Tip Calculator and	
Solution Command System Panel	11-5	Selector	11-26
Solution Pump Maintenance and		Use Steps and Handholds Correctly	2-9
Operation Recommendations	11-22	Wear Protective Clothing	2-2
Solution Pump Recommendations	11-19	Work in Ventilated Area	2-6
Solution Pumps	11-19	Working Area	2-7
Solution Strainers	11-33	Working Width	5-4
Solution System - Overview	11-3		
Solution System Cleaning - 25 Hours .	14-7		
Solution System Schematic	11-3		
Solution Tank	11-6		
Solution Tank Draining	11-16		
Solution Tank Fill Opening	11-7		
Solution Tank Filling	11-14		
Solution Tank Level Pressure Sensor .	11-7		
Solution Tank Rinse Nozzles	11-14		
Specific Gravity	5-4		
Specifications	17-1		

NOTES

NOTES

NOTES
