



TABLE OF CONTENTS

1 – INTRODUCTION

A Word From Hagie Manufacturing Company	1-1
About This Manual	1-1
Safety Messages Used In This Manual	1-2
Service and Assistance	1-2
Identification	1-2
Specifications	1-5
2017 Product Warranty	1-14

2 – SAFETY AND PRECAUTIONS

Intended Use	2-1
Safety Precautions	2-1
Seat Belt	2-6
Rotating Beacons	2-7
Emergency Stop	2-7
Emergency Exit	2-8
Fire Extinguisher	2-8
First Aid Kit	2-8
Safety Decals	2-9

3 – CAB

Seat - Operator (Premium)	3-1
Seat - Instructor	3-3
Operator's Station	3-3
Machine Display	3-25
Plow - Operation	3-51

4 – ENGINE AND DRIVE SYSTEMS

Engine - Starting	4-1
Engine Aftertreatment - Tier 4 Final	4-3
Hydrostatic Drive	4-10
All-Wheel Steer (AWS)	4-14

5 – HYDRAULIC SYSTEMS

Hydraulic System Components	5-1
Reversible Fan	5-4
Ladder	5-5

6 – ELECTRICAL SYSTEMS

Batteries	6-1
Battery Disconnect Switch	6-2
Battery Tender	6-3
Fuses and Relays	6-4

Fuse and Relay Ratings	6-9
Video Camera Input Connections	6-12
7 – SPRAY SYSTEMS	
Spray Booms - 90/100'	7-1
Solution System Components	7-6
Solution System - Operation	7-13
Filling Your Solution Tank	7-16
Draining Your Solution Tank	7-17
Application	7-18
8 – MAINTENANCE AND STORAGE	
Service - Fluids	8-1
Service - Filters	8-10
Service - Lubrication	8-21
Service - Engine Drive Belt	8-23
Service - Bolt Torque	8-24
Service - Toe-In	8-25
Service - Miscellaneous	8-27
Service Intervals	8-30
Storage	8-34
9 – MISCELLANEOUS	
Transporting	9-1
Lifting Your Machine	9-3
Quick-Tach System - Plow	9-5
Deluge System	9-13
Hand Wash System	9-14
Air Suspension Exhaust	9-16
Hood Operation	9-17
Troubleshooting	9-19



SECTION 1 – INTRODUCTION

A WORD FROM HAGIE MANUFACTURING COMPANY

Congratulations on the purchase of your GST20! Read this operator's manual and become familiar with operating procedures and safety precautions before attempting to operate your machine.

As with any piece of equipment, certain operating procedures, service, and maintenance are required to keep your machine in top running condition. We have attempted herein to cover all of the adjustments required to fit varying conditions. However, there may be times when special care must be considered.

NOTE: The operator is responsible for inspecting the machine and its attachments, as well as having parts repaired or replaced when continued use of the product causes damage or excessive wear to other parts.

Hagie Manufacturing Company reserves the right to make changes in the design and material of any subsequent GST20 without obligation to existing units.

Thank you for choosing a Hagie and we ensure you of our continued interest and support in its optimal performance for you. We are proud to have you as a customer!

ABOUT THIS MANUAL

NOTICE

This manual is only intended to cover the GST20 machine and the operation of plow and flail attachment controls. Refer to your attachment operator's manual for more detailed information, which could include complete operating instructions, safety precautions, specifications, and maintenance information.

NOTICE

Any pictures or illustrations contained within this manual that depict situations with shields, guards, rails, or lids removed are for demonstration only. Keep all shields and safety devices in place at all times.

This manual will aid you in the proper operation and service of your machine. It is the responsibility of the user to read the operator's manual and comply with the correct and safe operating procedures, as well as maintain the product according to the service information provided in the *Maintenance and Storage Section* elsewhere in this manual.

Photographs and illustrations used in this manual are of general nature only. Some of the equipment and features shown may not be available on your machine.

Information described in this manual was correct at the time of printing. Because of Hagie Manufacturing Company's continuous product improvement, certain information may not be included in this manual. To obtain the most current operator's manual for your machine, please visit www.hagiehelp.com.

Keep this manual in a convenient place for easy reference. This manual is considered a permanent fixture of the product. In the event of resale, this manual must accompany the machine.

If you do not understand any part of this manual or require additional information or service, contact your local John Deere dealer for assistance.

SAFETY MESSAGES USED IN THIS MANUAL

The following safety messages found throughout this manual alert you of situations that could become potentially dangerous to the operator, service personnel, or equipment.

 DANGER
This symbol indicates a hazardous situation which, if not avoided, will result in serious injury or death.

 WARNING
This symbol indicates a potentially hazardous situation which, if not avoided, could result in moderate/serious injury or death.

 CAUTION
This symbol indicates a potentially hazardous situation which, if not avoided, may result in minor or moderate injury. It may also be used to alert against unsafe practices.

NOTICE
This symbol indicates operator awareness which, if not avoided, may result in personal or property damage.

NOTE: A “Note” is intended to make special mention of, or remark on.

SERVICE AND ASSISTANCE

Please contact your local John Deere dealer for service and assistance.

IDENTIFICATION

NOTICE
Reference to right and left-hand used throughout this manual refers to the position when seated in the operator’s seat facing forward.

Each machine is identified by means of a frame serial number. This serial number denotes the model, year in which it was built, and the number of the machine.

For further identification, the engine, solution pump, hydraulic pumps, and attachments each have serial numbers, and the planetary wheel hubs have identification plates that describe the type of mount and gear ratio.

To ensure prompt, efficient service when ordering parts or requesting service repairs, record the serial numbers and identification numbers in the following spaces provided.

Machine

The machine serial number is stamped on the front right-hand side of frame (behind the front leg).



Machine Serial Number
-Typical View

Serial No. _____

Engine

The engine has an identification plate mounted on top of engine near the oil fill port that provides engine serial number, as well as other manufacturer information. Refer to your Parts Manual for specific part number.



Engine Identification Plate
-Typical View

Serial No. _____

Solution Pump

The solution pump has an identification plate mounted on the side of pump that provides pump serial number, as well as other manufacturer information. Refer to your Parts Manual for specific part number.



Solution Pump Identification Plate
* View shown from beneath machine
-Typical View

Serial No. _____

Hydraulic Pumps

The PC, LS, and Drive Pumps each have an identification plate mounted on the side of pump that provides pump serial number, as well as other manufacturer information. Refer to your Parts Manual for specific part number.



• PC Pump 1 • PC Pump 2 • LS Pump • Drive Pump

Hydraulic Pumps
* Top view shown
-Typical View

- _____ PC Pump 1
- _____ PC Pump 2
- _____ LS Pump
- _____ Drive Pump

Wheel Motors

The wheel motors each have an identification plate mounted on the side of motor that provides motor serial number, as well as other manufacturer information. Refer to your Parts Manual for specific part number.

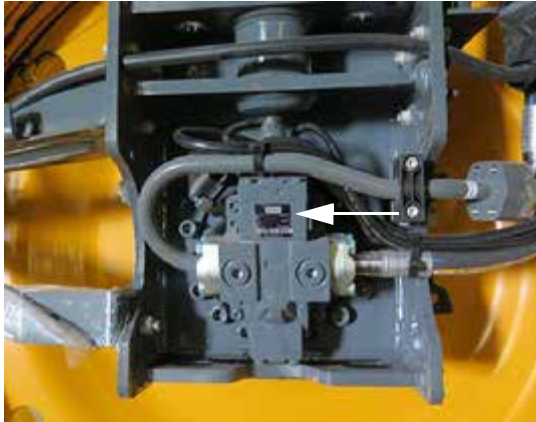

Wheel Motor Identification Plates
-Typical View

- _____ Right Front
- _____ Right Rear
- _____ Left Front
- _____ Left Rear

Wheel Hubs

The wheel hubs each have an identification plate mounted on the front of hub that provides hub serial number, as well as other manufacturer information, including gear ratio. Refer to your Parts Manual for specific part number.

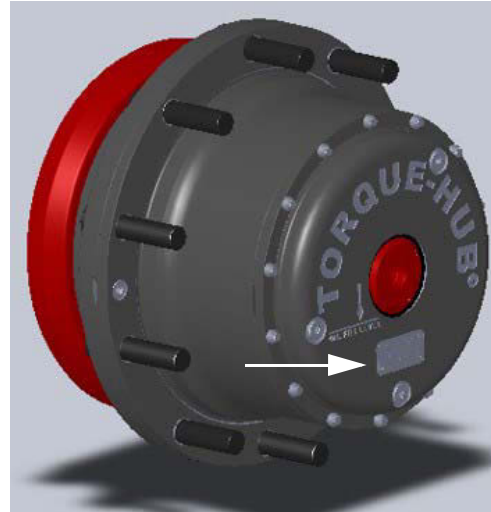

Wheel Hub Identification Plate
-Typical View

- _____ Right Front
- _____ Right Rear
- _____ Left Front
- _____ Left Rear

Spray Boom

Steel Spray Booms (90/100')

The steel spray boom serial number is stamped on the bottom right-hand side of transom.

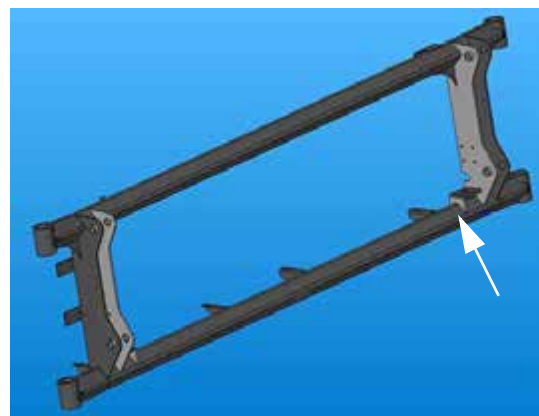

Steel Spray Boom Serial Number
-Typical View

Serial No. _____

SPECIFICATIONS

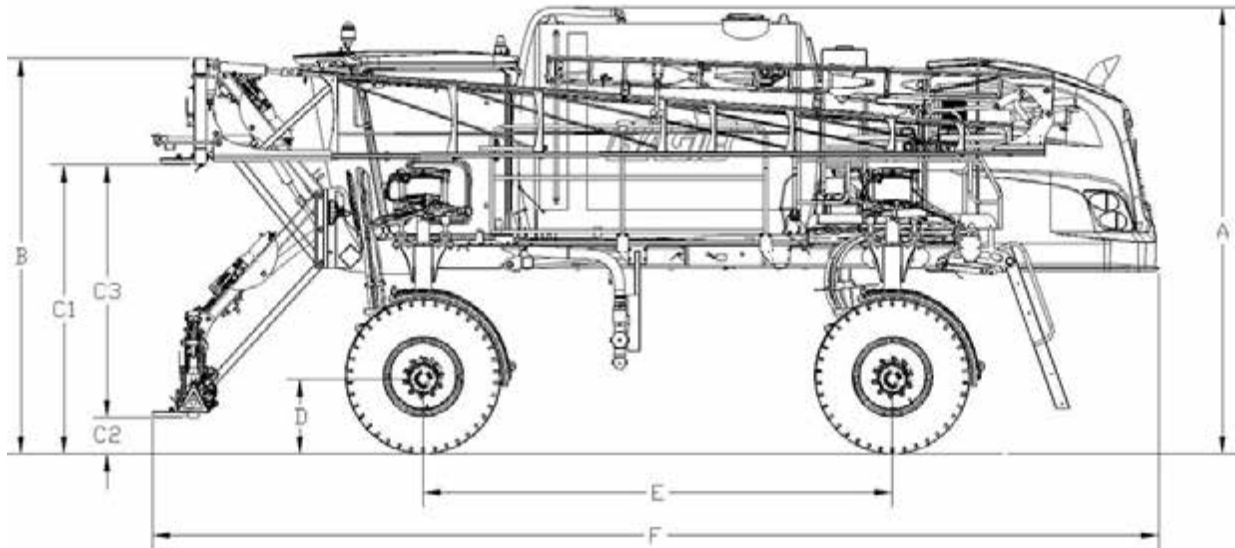

Detail	Description	Specification
		90-ft. Boom
A	Overall Machine Height (from top of tank) <i>NOTE: Machine height dimension does not include the cab-mounted rotating beacons or the optional GPS unit.</i>	154.25" (391.8 cm)
B	Raised Transom Height	141" (358.1 cm)
C3	Transom Lift Range (C1 minus C2)	89.5" (100.5" - 11") 227.3 cm (255.3 - 27.9 cm)
D	Static Loaded Hub Height	26" (66 cm)
E	Wheel Base	166" (421.6 cm)
F	Machine Length	360" (914.4 cm)
G	Width (booms folded)	144.25" (366.4 cm)
H	Frame Clearance (to tread adjust bolts)	61" (154.9 cm)
I	Lower Leg Clearance (from shield)	18" (45.7 cm)
J	Tread Width*	In = 120" (304.8 cm) Out = 154" (391.2 cm)

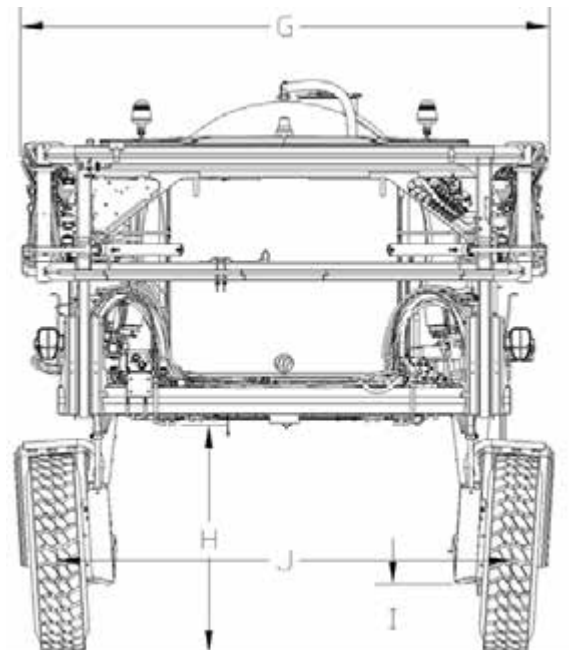

* Tread width is measured from center of tire at ground.

General Information

NOTICE

Because Hagie Manufacturing Company offers a variety of options, the illustrations in this manual may show a machine equipped other than standard. Height and weight values may vary, depending on available equipment.

- **Frame Type:** 4 x 8" (10.2 x 20.3 cm) modular platform frame
- **Suspension:** 4-wheel, individual, auto air-ride
- **Shipping Width:** 144.25"/366.4 cm (with 90/100' boom)
- **Approximate Dry Weight:**
 - 23,140 lbs./10,496 kg (machine only)
 - 27,160 lbs./12,319 kg (with 90' boom)

Spray System GPS Specifications

-If Equipped

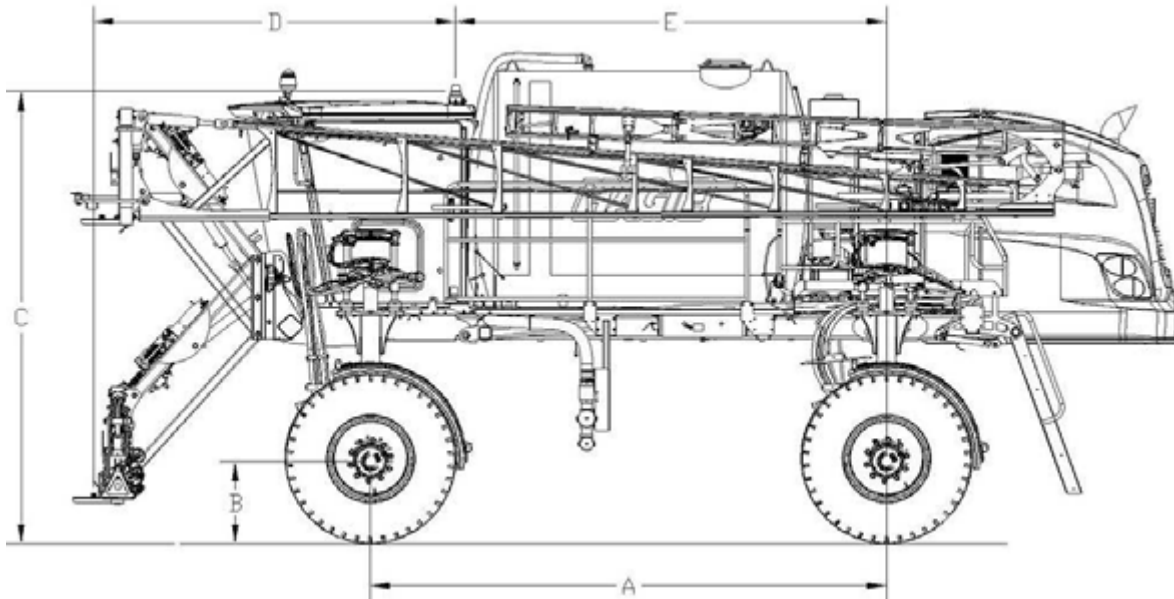

Detail	Description	Specification
A	Wheel Base	166" (421.6 cm)
B	Static Loaded Hub Height	26" (66 cm)
C	Overall Sprayer Height (from middle of GPS unit)	143" (363.2 cm)
D	Length (from front of boom spray tips to center of GPS unit)	124.25" (315.6 cm)
E	Length (from center of GPS unit to center of rear hub)	139.5" (354.3 cm)



Settings and Calibration

Record settings and calibration values used in the following spaces provided when programming your spray system console. Refer to this information for future reference.

Circle the selected setting on the spray system console for the following options:

Units	• US (Acres)		• SI (Hectares)		• Turf (1,000 sq. ft./ 92 sq. m)
Speed Sensor	• SP1 (Wheel Speed)		• SP2 (Radar/GPS)		
Control Type	• Liquid Spray	• Gran 1 (Single Belt Bed)	• Gran 2 (Split Belt Bed/Single Encoder)	• Gran 3 (Split Belt Bed/Dual Encoders)	• Spinner RPM Control
Valve Type	• Standard Valve	• Fast Valve	• Fast Close Valve	• Pulse Width Modulated Valve	• Pulse Width Modulated Close Valve

Record calculated calibration values in the spaces provided below.

Speed Cal	Section Widths	Meter Cal	Rate Cal	Valve Cal	Tank Volume
1.	1.	1.	1.	1.	1.
	2.	2.	2.	2.	2.
	3.	3.	3.	3.	3.
	4.	4.	4.	4.	4.
	5.	5.	5.	5.	5.
	6.				
	7.				
	8.				
	9.				
	10.				



Description	Specification
Engine	
Manufacturer	Cummins®
Model	QSB 6.7
Type	Electronic with air-to-air cooler and turbo charger
Number of Cylinders	6
Displacement	6.7 liters (408.9 c.i.)
Horse Power	300 hp (220.7 KW)
Fuel Type	Ultra-low sulfur diesel (ULSD)
Fuel System	Filtered, direct-injected
Air Cleaner	Dry-type, dual element
Engine Air Filter Restriction Monitors	Filter Minder® (electrical and mechanical)
Slow Idle	850 RPM
Fast Idle (no load)	2500 RPM
Hydrostatic Drive	
Hydrostatic Pump	Danfoss H1-Series
Drive Train	All-Wheel 4-Wheel Drive
Speed Ranges[^]	Speed Ranges 1-20 (operator selected)
Hydrostatic Wheel Motors	Danfoss H1-Series
Final Drives	Planetary gear reduction hubs (Fairfield C017)
• Lubrication	Oil bath
Brakes (Parking)	Multiple disk, spring applied, hydraulically released
Auxiliary Hydraulic System	
Steering System	Hydraulic, priority circuit, PC Pump
• Control	Full-time power
• Steering Cylinders	Double acting
• Turning Radius [^]	<ul style="list-style-type: none"> • 27 ft./8 m (No AWS/AWS “Off”) • 20 ft./6 m (AWS “On”, if equipped)
All Wheel Steer (AWS) - if equipped[^]	Coordinated steering
Solution System Hydraulic Pump	Load Sense (LS) Pump
Cooling Fan Hydraulic Pump	PC Pump



Spray System	
Booms	90/100-ft. (9 sections)
• Type	1" (2.5 cm) schedule 5 stainless wet boom plumbing
• Controls	Electro-hydraulic (fold/lift/level)
• Level Shock Absorber	Gas charged accumulator
• 90/100-ft. Outer Boom Hydraulic Breakaway	Self-actuated, auto-reset hydraulic
Solution Fill Connection	
• Quick-fill Connection	3" (7.6 cm) inner diameter
Solution Tank	Stainless steel
General Spray System	
• Pump	<ul style="list-style-type: none"> • Centrifugal-hydraulically driven w/proportional control valve • Hypro® 9306-HM1C-BU w/silicon carbide seals • 3" (7.6 cm) inlet/2" (5.1 cm) outlet plumbing
• Flow Meter	Electromagnetic: 3-190 GPM (11.4-719.2 l/min)
• Boom Solution Valves	Ball valves, electric actuation, stainless ball and stem, PTFE seats
• Pressure Gauge	100 PSI (6.9 bar), glycerin filled
• Console	Raven
Solution Circuit Pressure	100 PSI (6.9 bar) - maximum
Electrical System	
General Electrical System	
• Battery	Dual 12V, negative ground (CCA)
• Alternator	200 AMP, voltage regulated
• Starter	12V with solenoid
Lights (Exterior)	
• Front of Cab	2 trapezoidal headlights, 2 floodlights, 2 rotating amber beacon lights
• Transom	2 trapezoidal headlights
• Transom Mount	2 trapezoidal headlights (high/low beam), 2 oval amber lights (combined)
• Boom Cradle	2 trapezoidal floodlights (1 on each cradle), 2 oval amber lights (1 on each cradle)
• Rear Engine Hood	2 round red lights, 2 round amber lights



• Spray Boom Indicators (located on boom, if equipped)	1 oval white, 2 oval amber, 9 oval red
Cab and Instruments	
Sound Level (cab interior)	86 dBA (maximum)
Cab (General)	Tilt steering, wipers/washers, dual side mirrors, dome light, tinted glass, instructor seat
Temperature Control	Full range
A/C Charge Type	R-134a
Fresh Air Filtration	<ul style="list-style-type: none"> • RESPA® cab filter • Charcoal filter
Seat	Air-ride
Instruments	Tachometer (RPM), fuel level, engine coolant temperature, aftertreatment level
Machine Display	Hour meter, battery voltage, engine oil pressure, ground speed, engine diagnostics, parking brake, machine/engine malfunction warnings, engine exhaust filtration warning, high exhaust temperature warning, low hydraulic oil level, low coolant level, low fuel level, grid heater, cab air pressure
Stereo	AM/FM radio with CD/MP3/Bluetooth
Fluid Capacities	
Solution Tank	2000 gallons (7570 L)
Fuel Tank	170 gallons (643 L)
Engine Oil Pan (including filter and cooler)	17.6 quarts (16.7 L), SAE 15W-40
Engine Oil Dipstick (L-H mark)	2 quarts (1.9 L)
Engine Cooling System (including block, lines, and radiator)	14 gallons (53 L), ethylene glycol
Diesel Exhaust Fluid (DEF) Tank (Tier 4 Final Engines)	10 gallons (37 L), diesel exhaust fluid
Hydraulic Oil (including lines, filter, cooler, etc.)	90 gallons (340 L)
Hydraulic Oil Reservoir	37 gallons (140 L)
Wheel Hubs (4)	62 oz. (1.83 L)/each, 75W-90 synthetic gear oil
Hand Wash Tank	4 gallons (15 L)
Deluge Solution Reservoir	45 gallons (170 L)

^ Operators with machines equipped with All-Wheel Steer (AWS) pay special attention.

TIRE SPECIFICATIONS (STANDARD)											
Size	Make	Model	Min. Dual Spacing (in.)	Overall Width (in.)	Overall Diameter (in.)	Load Sect & Growth (in.)	Static Load Radius (in.)*	Revol. Per (mi.)	Gross Contact Area (in. 2)	Tire Vol. (gal.)	Tread Depth (1/32 in.)
14.00 R25NHS	Goodyear®	RL-4L (E-4)	17.7	14.7	55.5	16.8	24.6	378	167	66.4	47

TIRE SPECIFICATIONS (METRIC)											
Size	Make	Model	Min. Dual Spacing (mm)	Overall Width (mm)	Overall Diameter (mm)	Load Sect & Growth (mm)	Static Load Radius (mm)	Revol. Per (km)	Gross Contact Area (cm 2)	Tire Vol. (ltrs.)	Tread Depth (mm)
14.00 R25NHS	Goodyear	RL-4L (E-4)	450	373	1410	427	625	236	1079	251.3	37

* Static load radius is suggested and will vary with load.



TIRE LOAD LIMITS (LBS) AT VARIOUS COLD INFLATION PRESSURES (PSI)											
		Inflation (psi)	65	69	73	76	80	83	87	91	94
14.00 R25NHS	Goodyear		8800	9100	9650	9900	10200	10500	11000	11400	11700

TIRE LOAD LIMITS (LBS) AT VARIOUS COLD INFLATION PRESSURES (PSI) (CONTINUED)											
		Inflation (psi)	98	102	105	109	112	116			
14.00 R25NHS	Goodyear		12000	12300	12300	12800	13200	13600*			

* Available in ply ratings.

NOTE: There are no adjustments to the loads and pressures in the above table for lower speeds or stationary service.

NOTE: Minimum inflation pressures for IF agricultural tires used as singles = 12 psi.

TIRE LOAD LIMITS (KG) AT VARIOUS COLD INFLATION PRESSURES (BAR)											
		Inflation (bar)	4.5	4.8	5.0	5.2	5.5	5.7	6.0	6.3	6.5
14.00 R25NHS	Goodyear		3991	4127	4377	4490	4626	4762	4989	5171	5307

TIRE LOAD LIMITS (KG) AT VARIOUS COLD INFLATION PRESSURES (BAR) (CONTINUED)											
		Inflation (bar)	6.8	7.0	7.2	7.5	7.7	8.0			
14.00 R25NHS	Goodyear		5443	5579	5579	5806	5987	6168*			

* Available in ply ratings.

NOTE: There are no adjustments to the loads and pressures in the above table for lower speeds or stationary service.

NOTE: Minimum inflation pressures for IF agricultural tires used as singles = .8 bar.



2017 PRODUCT WARRANTY

Hagie Manufacturing Company LLC Product Warranty

A. General Provisions. Hagie Manufacturing Company LLC (“Hagie”) warrants each new product manufactured by Hagie (“Product(s)”) to be free, under normal use and service, from defects in workmanship and materials for a period of the lesser of: two (2) years from the date of delivery or 1000 hours of use (“Term”). Hagie makes this warranty to original purchasers of Products from the original delivery date. This warranty is transferable, provided Hagie is notified of the ownership change and Hagie approves the warranty transfer.

B. Warranty Claims. During the Term, this warranty shall be fulfilled by repairing or replacing free of charge any Product that shows evidence of defect in workmanship or materials. To secure warranty service, the purchaser must 1) report the Product defect to Hagie or an authorized Hagie Service Provider (a list of authorized Hagie Service Providers can be found at <http://www.hagiehelp.com/RegionalSupport.aspx>), 2) present evidence of the warranty start date with valid proof of purchase, and 3) make the Product available to Hagie or an authorized Hagie Service Provider within a reasonable time. Labor to repair said items will be covered by standard labor time rates. Freight charges for defective Products are not covered by this warranty and are the responsibility of the purchaser.

C. Exclusions. Excluded from this warranty are: 1) Used Products; 2) repairs or replacements caused in whole or in part by parts or components not manufactured by or obtained from Hagie or by service not performed by Hagie authorized personnel or an authorized Hagie Service Provider; 3) any Product that has been altered or modified in ways not approved by Hagie, including but not limited to modifications to the engine management, fuel, air intake and exhaust systems and the use of unapproved wheels, tracks, tanks or booms; 4) depreciation or damage caused by normal wear and tear, lack of reasonable and proper maintenance, failure to follow operating instructions/recommendations, misuse, lack of proper protection during storage, vandalism, the elements, collision or accident; and 5) normal maintenance parts and/or service, including but not limited to engine tune ups, adjustments, inspections, and any consumables, including but not limited to tires, rubber products, solution system valves, wear parts and wiper blades.

D. No Other Express Warranty and no Implied Warranty, Representation or Condition. No other express warranty is given and no affirmation of Hagie or an authorized Hagie Service Provider by words or actions, shall modify the terms or limitations of this warranty in any way. No retailer has any authority to make any warranty, representation, condition or promise on behalf of Hagie, or to modify the terms or limitations of this warranty in any way. Hagie shall not be liable for damages, including special, incidental or consequential damages or injuries (damage and repairs of equipment itself, loss of profits, rental or substitute equipment, loss of good will, etc.) arising out of or in connection with performance of the Product or its end use, and Hagie shall not be liable for any indirect, special, incidental, punitive or consequential damages arising out of or in connection with Hagie’s failure to perform its obligations hereunder. Purchaser acknowledges that it is not relying on Hagie’s skill or judgment to select Products for any purpose and that there are no warranties which are not contained in this warranty. In no event shall Hagie’s tort, contract, or warranty liability exceed the purchase price of the Product.

TO THE EXTENT PERMITTED BY LAW, HAGIE’S ENTIRE LIABILITY AND THE PURCHASER’S EXCLUSIVE REMEDY SHALL BE REPAIR OR REPLACEMENT OF PRODUCTS COVERED UNDER THIS WARRANTY. THIS WARRANTY IS IN LIEU OF ALL OTHER WARRANTIES, EXPRESS OR IMPLIED, INCLUDING, BUT NOT LIMITED TO THE IMPLIED WARRANTY OF MERCHANTABILITY OR FITNESS FOR A PARTICULAR PURPOSE.



SECTION 2 – SAFETY AND PRECAUTIONS

INTENDED USE

NOTICE

This machine is designed for airport runways and grassy areas and intended to be used for:

- Application of chemicals with boom attachment.
- Snow removal from lights with snow plow attachment.
- Mowing with flail mower attachment.

Use in any other way or for any other purpose is considered misuse of this machine.

Most accidents occur as the result of failure to follow basic and fundamental safety rules and precautions. Recognizing potential safety hazards, following correct and safe operating procedures described in this manual, and complying with safety warnings located throughout the machine may reduce the risk of accidents.

There is no way to completely eliminate the potential for danger when operating mobile machinery. Therefore, you must study this operator's manual and understand how to operate the GST20 controls for safe operation before using the machine, its attachments, or any GST20 equipment. Likewise, never let anyone operate the machine without proper instruction.

Do not operate the machine, its attachments, or any GST20 equipment for anything other than their intended uses. Hagie Manufacturing Company shall not be liable for any damage, injury, or death associated with improper use of the machine, its attachments, or any GST20 equipment.

Do not make any modifications such as, but not limited to, weldments, add-ons, adaptations, or changes from the original design of the

machine. Such modifications may become safety hazards to you and others and **will void all warranties.**

Replace missing, faded, or damaged safety signs. Refer to "Safety Decals" elsewhere in this section for correct sign and placement.

SAFETY PRECAUTIONS

NOTE: If your machine is equipped with All Wheel Steer (AWS), pay special attention to components, operating instructions, and safety precautions marked with [^].

Do Not Bypass Safety Start

- Start the machine from the operator's seat only.
- The parking brake must be engaged before starting the engine.



Use Caution While Driving [^]

- Never drive near ditches, embankments, holes, mounds, or other obstacles.
- Never drive on hills too steep for safe operation.



- Reduce machine speed before turning.

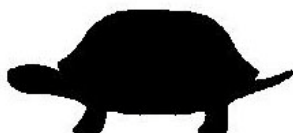

- Do not permit passengers to ride on the machine while it is moving. Failure to comply may result in passenger falling off of machine and/or obstructing the operator's view.



- Keep riders off machine. The only time a passenger should be permitted to ride inside the cab is for instructional or diagnostic purposes only. The passenger should be seated in the instructor seat next to the operator and never allowed to ride outside of the cab.
- Ensure there is adequate clearance before driving under any overhead obstructions. Contact with power lines may result in serious injury or death.



- Booms must be folded and in cradles when driving the machine on a roadway or when near power lines.

Remove Paint Before Welding or Heating

- Avoid toxic fumes and dust. Hazardous fumes can be generated when paint is heated by welding, soldering, or using a torch.



- Do not use chlorinated solvents in areas where welding will take place.
- Perform all work in an area that is well ventilated to carry toxic fumes and dust away.
- Dispose of paint and solvents properly.

Avoid Heating Near Pressurized Lines

- Avoid torching, welding, and soldering near pressurized hydraulic lines. Pressurized lines may accidentally burst when heat goes beyond the immediate flame area.



Handle Fuel Safely

- Always turn the engine off and allow it to cool before refueling.
- NEVER smoke while refueling.



- Do not fill tank completely, as fuel may expand and run over.
- Always clean up spilled fuel with soapy water.
- Keep a fire extinguisher nearby when refueling.



Operate Safely ^

- Before moving the machine, ensure there are no obstacles or persons in the path of travel.
- Never operate a machine in the same vicinity as walking personnel.
- Always drive at a reasonable operating speed.
- Never operate the machine on a roadway with solution in the tank. Additional weight caused from a full or partially full solution tank may cause erratic or increased stopping distance.
- Do not operate the machine at speeds exceeding 20 mph (32 km/h) with solution in the tank. Operating speeds exceeding 20 mph (32 km/h) with a fully loaded tank may result in tire blow-out or wheel hub damage and will void the warranty.
- Ensure the Slow Moving Vehicle (SMV) emblem and the Speed Indicator Symbol (SIS) are in place and visible from the rear of machine when traveling on public roadways.



SMV



SIS (mph)



SIS (km/h)

- Pull over to the side of the road before stopping.
- Always come to a complete stop before reversing directions.
- Ensure the back-up alarm is audible when operating the machine in reverse.
- Keep a fire extinguisher nearby at all times.

- Keep ALL shields in place.
- Keep clear of all moving parts and keep others away while operating (including the reversible fan).
- Do not activate the parking brake while the machine is in motion.
- Bring machine to a gradual stop to avoid sudden downward decent.
- Reduce speed for icy, wet, graveled, or soft roadway surfaces.
- Use flashers/hazard warning lights (day or night) unless prohibited by law.
- Keep away from overhead power lines. Serious injury or death may result to you or others should the machine come into contact with electrical power lines.
- Never use starting fluid to assist engine start-up.
- If your machine is equipped with ground speed sensing radar, do NOT look directly into radar beam, as it emits a very low intensity microwave signal, which may result in possible eye damage.

Be Prepared

- Be prepared for an emergency. Keep a fire extinguisher, first aid kit, and clean water in the cab at all times.
- Service the fire extinguisher regularly.
- Keep an accurate inventory of supplies in the first aid kit and dispose of any item(s) that have expired.

Wear Protective Clothing

- Do not wear loose fitting clothing that could get caught in moving parts. Wear safety equipment that is appropriate for the job.



- Do not store chemical-soaked clothing in the cab. Clean off as much mud and dirt from your shoes as you can before entering the cab.

Protect Against Noise

- Wear suitable hearing protection. Prolonged exposure to loud noise may result in loss of hearing.



Battery Acid Accident Prevention

Avoid serious injury by avoiding battery acid contact with your body. Battery electrolyte contains sulfuric acid that is strong enough to eat holes in clothing and cause blindness if splashed into eyes.

Make sure to:

- Fill batteries in a well ventilated area.
- Wear Personal Protective Equipment (PPE) when servicing a battery.
- Avoid inhaling of fumes when recharging with electrolyte.
- Avoid spilling or dripping electrolyte.
- When charging a battery, connect positive cable to positive terminal and negative cable to negative terminal. Failure to comply may result in an explosion and/or personal injury.

If you spill on yourself:

- Flush affected area with cold water and remove contaminated clothing immediately. Continue to flush the area for a minimum of 15 minutes.



- Call a physician.

- While transporting or waiting for medical attention, apply compresses of iced water or immerse affected area in iced water. **DO NOT ALLOW SKIN TISSUE TO FREEZE.**
- Do not apply creams or ointments until you have been seen by a physician.

If acid is swallowed:

- Do NOT induce vomiting.
- Drink large amounts of water.
- Seek medical attention immediately!
- Do not neutralize the acid.

If fumes are inhaled:

- Move the person into fresh air.
- Do not give artificial respiration to a person that is able to breath on their own.
- Give CPR only if there is no breathing and no pulse.
- Seek medical attention immediately!

Handle Chemicals Safely

Chemicals used in applications can be harmful to your health and the environment if not used properly.

- Always follow the manufacturer's instructions for mixing chemicals and directions of use.
- Never allow chemicals to come in contact with your skin or eyes. Always use the proper Personal Protective Equipment (PPE) as recommended by the chemical manufacturer.
- Never pour chemicals into an empty tank. Always fill tank half full of water first.
- Dispose of empty chemical containers properly.



- Wash spilled chemicals or spray residue from the machine to prevent corrosion and deterioration.

- Select a safe area to fill, flush, calibrate, and clean the machine where chemicals will not run off to contaminate people, animals, vegetation, or water supply.
- Never place a spray tip/nozzle to your mouth in an attempt to unplug it.
- Do not spray when wind is in excess of chemical manufacturer's recommendation.
- Store chemicals in their original containers with the label intact.
- Store chemicals in a separate, locked building.

Safe Hydraulic Maintenance

- Always practice personal safety when performing service or maintenance on the hydraulic system.
- Use caution when working around hydraulic fluid under pressure. Escaping fluid can have sufficient force to penetrate your skin, possibly resulting in serious injury. This fluid may also be hot enough to burn.

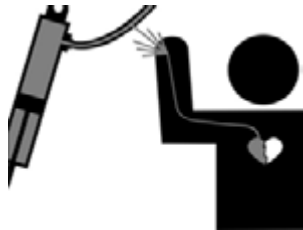

- Always lower the load or relieve the pressure before repairing a hydraulic oil leak.

Beware of Exhaust Fumes

- Never run the machine in an enclosed area. Proper ventilation is required. Use an exhaust pipe extension to remove fumes if you must operate inside a building. Also, open doors and windows to bring in enough outside air into the area.

General Maintenance Safety

- Turn off engine before checking, adjusting, repairing, lubricating, or cleaning any part of the machine.

- Remove all chemical residue from the work area before performing service/maintenance.
- When servicing the radiator, allow engine to cool before removing the pressurized cap.



- Disconnect battery ground cable and turn the Battery Disconnect Switch OFF before servicing the electrical system or welding on the machine.



- Machines equipped with All Wheel Steer (AWS) have position sensing internal to the steering cylinders. Disconnect each sensor before welding on the machine. ^

Spray Booms

- Select a safe area before unfolding/folding the booms.
- Clear area of personnel.
- Cradle booms when leaving the sprayer unattended.
- Ensure booms are folded when cradled.
- Do not unfold boom extension when main boom is in the cradle.
- Do not operate the sprayer with one boom wing out of cradle and other boom wing in cradle.
- Check for overhead obstructions.
- Do not unfold or fold booms near power lines. **Contact with power lines can result in serious injury or death.**



A warning message will appear on the Machine Display before extending the outer boom extensions. Press ACKNOWLEDGE showing that you have acknowledged that there are no overhead power lines or obstructions before proceeding.

Cold Oil Scenarios

- If the oil temperature is less than 50°F, the operator may experience control loss on the 90-ft. and 100-ft. fold cylinders. These cylinders are the main cylinders affected by over-running loads due to the weight rotation of the boom during unfold/fold situations.

When the oil is cold, the valve response is not as fast or accurate. Therefore, when having to lift the weight, the cylinder will move slower, but in trying to suspend the weight, the weight may cause faster movement, as the valve is not dampening the flow like it normally would.

NOTE: This situation requires the operator to ensure no one is near the boom during operation.

Plow Attachment

- Clear area of personnel.
- Ensure the plow is in the fully lowered position before performing maintenance.
- Refer to the plow manufacturer's operation manual for further safety precautions.

Flail Attachment

- Clear area of personnel.
- Rotating cutter blades. Stay away from moving parts.
- Ensure the attachment is in the fully lowered position before performing maintenance.
- Refer to the flail manufacturer's operation manual for further safety precautions.

All Wheel Steer (AWS) Safety ^

–If Equipped

Many of the following precautions are repetitious to the precautions for a standard machine. It is imperative they receive special consideration. Failure to comply with the AWS safety precautions and operating instructions may result in property damage, serious injury, or death.

- Become familiar with and understand how to operate your machine in conventional steering mode before operating with AWS.
- Understand AWS system components, operating procedures, and system limitations before operating.
- Reduce machine speed before turning.
- Never drive on hills too steep for safe operation.
- Never drive near ditches, embankments, holes, mounds, or other obstacles.
- Come to a complete stop before reversing directions.
- Always drive at a reasonable operating speed.

SEAT BELT

For your safety, wear seat belt at all times when operating the machine.

Seat Belt Operation

- Grasp the Seat Belt Buckle (located on the outward side of seat) and extend all the way across your hips, seated below your abdomen.
- Insert the buckle tongue into the receptacle assembly (located on the opposite side of seat) and engage into LOCKED position.
- **To release Seat Belt**, press the Release Button (located on the receptacle end) and allow belt to retract.

Inspection/Replacement

Inspect seat belt and mounting hardware yearly. Replace seat belt if anchorage system, buckle, belt, or retractor shows signs of damage, including evidence of cuts,

fraying or wear, discoloration, or being heavily soiled - especially with oil grease or fuel. Replace only with replacement parts approved for your machine.

ROTATING BEACONS

The Rotating Beacons (located on each side of the front roof cap) are used for increased visibility to others. The beacons will illuminate when the Hazard/Warning Lights Switch (located on the steering column) is activated.

NOTE: The Rotating Beacons are active in both Road and Field mode. The Hazard/Warning Lights are active in Road mode only.



Rotating Beacon (2)
(Located on each side of front roof cap)
-Typical View

EMERGENCY STOP

(E-Stop)

NOTICE

Do not use the E-Stop Switch for non-emergency stopping or as a parking brake.

The E-Stop Switch (located on the side console) provides a quick and positive method for stopping the engine in an emergency situation.

When the E-Stop Switch is depressed, it locks in position and removes the ignition signal to shut down the engine. To reset the E-Stop Switch, turn the switch in the direction of the arrows (located on the face of the button).



E-Stop Switch
(Located on the side console)
-Typical View

When the E-Stop Switch is activated, a message will appear on the Machine Display to alert the operator that the E-Stop is engaged. Press OK to acknowledge.



E-Stop Active Message
(Located on the Machine Display)

EMERGENCY EXIT

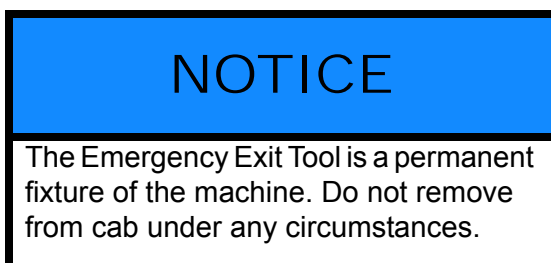
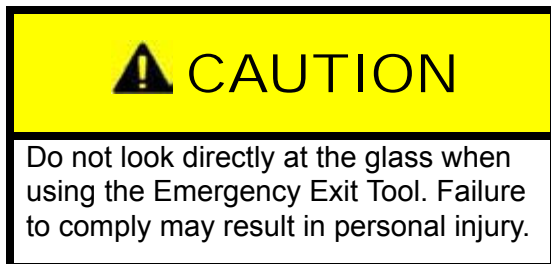

In the event of an emergency, use the cab door to exit the machine. Should the cab door become inoperable, an Emergency Exit Tool (located along the rear right-hand side of cab) is provided and is used in the rare event to shatter the glass of the cab.

- Using the metal end of the Emergency Exit Tool, repeatedly strike the glass to shatter.



Emergency Exit Tool
(Located along rear right-hand side of cab)
-Typical View

Should the need arise to escape from a seat belt that may become inoperable, use the “hook end” of the Emergency Exit Tool to cut the seat belt.

FIRE EXTINGUISHER

Your machine is equipped with a Fire Extinguisher (located along platform on the left-hand side of machine). In the event that use of the Fire Extinguisher is required, follow the manufacturer’s operating instructions provided on the Fire Extinguisher.

To Remove Fire Extinguisher

- Pull the Security Latch **OUTWARD** to disengage and remove Fire Extinguisher.



Fire Extinguisher
(Located along platform on left-hand side of machine)
-Typical View

Inspection and Replacement

Follow the manufacturer’s recommendations on inspection and replacement.

FIRST AID KIT

-If Equipped

A First Aid Kit (located beneath the operator’s seat) is provided for your convenience.

NOTE: Keep an accurate inventory of supplies in the First Aid Kit and dispose of any item(s) that have expired.



First Aid Kit
(Located beneath the operator's seat)
-Typical View

Safety Decal Locations

650164

(Located on rear left-hand cab post)



650174

(Located on top of radiator)



SAFETY DECALS

Decals warning you of avoidable danger are located on various parts of the machine and attachment. They are there for your personal safety and protection. **DO NOT** remove them. They will fracture upon attempted removal and therefore, must be replaced.

Following are locations of important safety decals. Replace them if they are damaged or missing. All safety decals, instructional decals, or machine striping may be purchased through your local John Deere dealer.

To replace safety decals, ensure the installation area is clean and dry and decide on exact position before you remove the backing paper.

650176
(Located on rear right-hand cab post)



650178
(2) - Quick-Tach



650277
(4) - Located near each lifting point containment ring



RISK OF INJURY DUE TO IMPROPER LIFTING.
DO NOT ATTEMPT TO LIFT MACHINE
WITHOUT JACKS PROPERLY SEATED IN THE
LIFTING POINT CONTAINMENT RINGS.

650295
(Located on rear frame around booster terminals)



650296
(Located on rear frame near booster terminals)



650339
(Located on front cross member)



650348
(Located on air tank)



650430
(Located near hydraulic oil reservoir sight gauge)

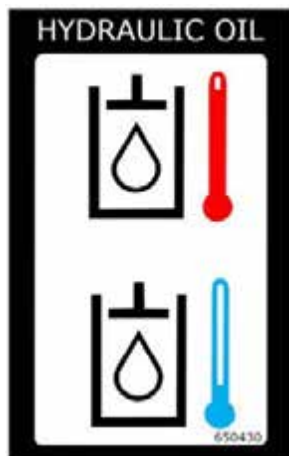

HYDRAULIC OIL RESERVOIR
LEVEL/TEMPERATURE

650431
(Located near fuel fill - Tier 4 engines only)



650434
(Located near reversible fan)



CUTTING/SEVERING OF FINGERS OR HAND.
DO NOT PLACE FINGERS OR
HAND NEAR MOVING FAN BLADES.

650462
(Located near radiator cap)



650474
(Located on rear right-hand cab post)



READ OPERATOR'S MANUAL.
REMOVE KEY AND READ MAINTENANCE
SECTION OF OPERATOR'S MANUAL
BEFORE SERVICING.

650542
(Located near charge ports beneath machine)

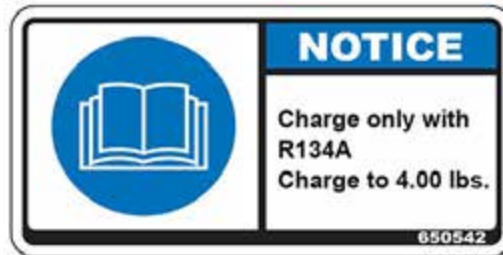

650849
(Located near fuel cap)

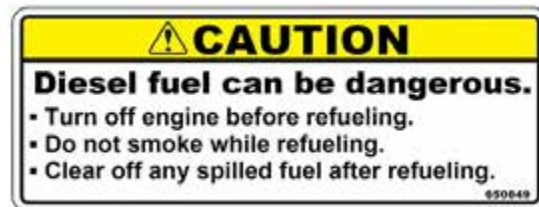

650850
(Located on solution tank near fill lid)



650851
(Located near shields)



650541
(Located near solution tank opening)

DANGER



NEVER ENTER SOLUTION
TANK WITH WHOLE BODY.
FAILURE TO COMPLY WILL RESULT
IN SERIOUS INJURY OR DEATH.

90/100' Boom Decals**650203**

(Located on transom)

**650204**

(4) - Located near each fold point

**650208**

(Located on transom)





SECTION 3 – CAB

SEAT - OPERATOR (PREMIUM)

-If Equipped

Your machine may be equipped with a Premium Air Ride Operator's Seat that is equipped with the following features for your driving and comfort needs.

- (A) - Headrest
- (B) - Heat/Cool Selector Switch
- (C) - Heat/Cool Temperature Switch
- (D) - Armrest Tilt Dial
- (E) - Height Adjustment Switch
- (F) - Recline Lever
- (G) - Slide Release Lever
- (H) - Thigh Tilt Lever
- (I) - Thigh Extension Lever

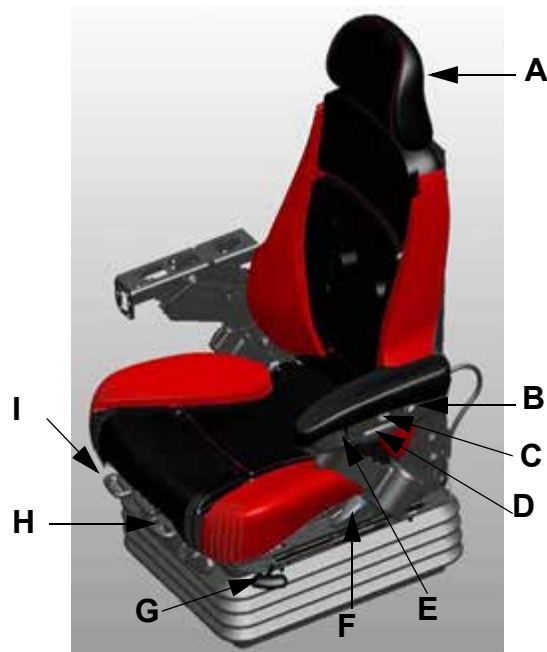

- (J) - Armrest Height Adjuster
- (K) - Fore/Aft Lockout Isolator
- (L) - Lateral Lockout Isolator
- (M) - Ride Firmness Lever



- (N) - Armrest Height/Length Adjuster
- (O) - Lumbar Knob
- (P) - Document Pouch

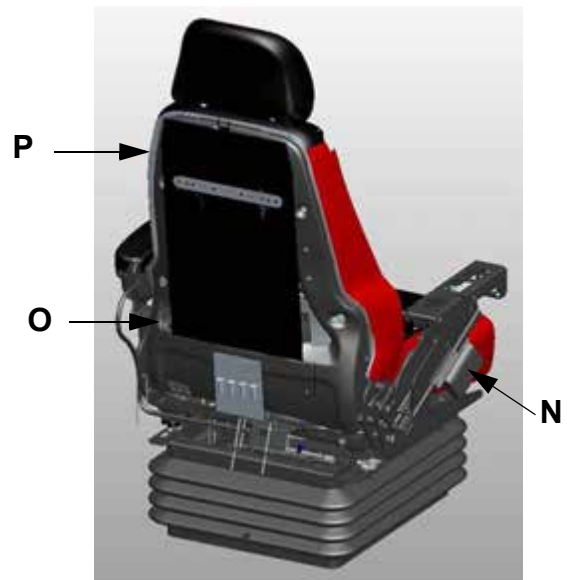

Headrest (A)

(Adjusts height and tilt)

- Firmly grasp headrest and pull UP for higher adjustment.

- Firmly grasp headrest and push DOWN for lower adjustment.

Tilt:

(First Position: hold and rotate down 10-degrees; Second Position: hold and rotate down 20-degrees; Third Position: hold and rotate down 30-degrees. Hold and rotate down to return Headrest to 0-degree position).

Heat/Cool Selector Switch (B)

(Selects between heat and cool settings)

- Press Heat/Cool Selector Switch FORWARD to cool.
- Press Heat/Cool Selector Switch REARWARD to heat.

Heat/Cool Temperature Switch (C)

(Switches heat/cool temperature to high, low, or off settings)

- Press Heat/Cool Temperature Switch UP for HIGH heat or cool.
- Press Heat/Cool Temperature Switch DOWN for LOW heat or cool.
- Press Heat/Cool Temperature Switch to the MID position to turn OFF.

Armrest Tilt Dial (D)

(Tilts armrests)

- Roll Armrest Tilt Dial (located on each side of operator's seat) INWARD (towards operator) to tilt armrest DOWN.
- Roll Armrest Tilt Dial OUTWARD (away from operator) to tilt armrest UP.

Height Adjustment Switch (E)

(Moves seat up and down)

- Press Height Adjustment Switch UP to increase seat height.
- Press Height Adjustment Switch DOWN to decrease seat height.

Recline Lever (F)

(Angles back rest cushion)

- Pull and hold Recline Lever UP to adjust back rest angle. Release lever when desired angle is achieved.

Slide Release Lever (G)

(Moves top of seat fore/aft)

- Pull and hold Slide Release Lever while sliding seat forward or rearward.

Release lever when desired position is achieved.

Thigh Tilt Lever (H)

(Tilts seat cushion up and down)

- Pull Thigh Tilt Lever UP and hold cushion to adjust +4 degrees. Release lever when desired position is achieved.
- Pull Thigh Tilt Lever UP and push cushion down to adjust -4 degrees. Release lever when desired position is achieved.

Thigh Extension Lever (I)

(Extends seat cushion fore/aft)

- Pull Thigh Extension Lever UP and hold to adjust cushion +/- 30 mm. Release lever when desired position is achieved.

Armrest Height Adjuster (J)

(Adjusts armrest height)

- Loosen two (2) bolts and move armrests up or down.
- While maintaining desired armrest position, re-tighten bolts.

Fore/Aft Lockout Isolator (K)

(Locks or unlocks fore/aft isolation)

- Pull Fore/Aft Lockout Isolator UP to unlock isolation.
- Push Fore/Aft Lockout Isolator DOWN to lock isolation.

Lateral Lockout Isolator (L)

(Locks or unlocks lateral isolation)

- Pull Lateral Lockout Isolator UP to lock isolation.
- Push Lateral Lockout Isolator DOWN to unlock isolation.

Ride Firmness Lever (M)

(Adjusts ride suspension)

- Pull Ride Firmness Lever UP for a firmer ride.
- Push Ride Firmness Lever DOWN for a softer ride.

Armrest Height/Length Adjuster (N)

(Adjusts height and length of armrest)

- Pull and hold Armrest Height/Length Adjuster and slide forward or rearward. Release adjuster when armrest is in desired position.

Fore/Aft Adjustment: +/- 76 mm at 12.7 mm increments; **Up/Down Adjustment** +/- 35 mm at 5.4 mm increments.

NOTE: Armrest tilt fixed position = 25 degrees.

Lumbar Knob (O)

(Adjusts lumbar curvature)

- Rotate Lumbar Knob INWARD (toward operator) for increased curve.
- Rotate Lumbar Knob OUTWARD (away from operator) for decreased curve.

Document Pouch (P)

(Storage for various machine manuals)

- Pull Document Pouch Fastener to OPEN.
- Push Document Pouch Fastener to CLOSE.

Seat Belt

Refer to “Seat Belt” provided in the *Safety and Precautions Section* elsewhere in this manual for further information.

SEAT - INSTRUCTOR

The cab area is featured with an Instructor Seat to allow an instructor/trainer to be seated and instruct on how to operate the machine.



Instructor Seat
-Typical View

A storage compartment and cup holders are located beneath the Instructor Seat for your convenience. Lift hinged seat to access.



-Typical View

OPERATOR'S STATION

Front Console

- (A) - Hazard/Warning Lights Switch
- (B) - Highway/Running Lights Switch
- (C) - Steering Wheel
- (D) - Turn Signal Indicator (Left)
- (E) - Highway Running Lights Indicator
- (F) - High Beams Indicator
- (G) - Turn Signal Indicator (Right)
- (H) - Steering Wheel Telescope Adjust Handle
- (I) - Steering Column Tilt Adjust Button (Knee Angle)
- (J) - Steering Column Release Pedal
- (K) - Deceleration (Decel) Pedal
- (L) - Operator Foot Pegs (2)
- (M) - Horn
- (N) - Windshield Washer
- (O) - Turn Signal Lever
- (P) - Windshield Wiper Speed
- (Q) - High Beams (Brights)

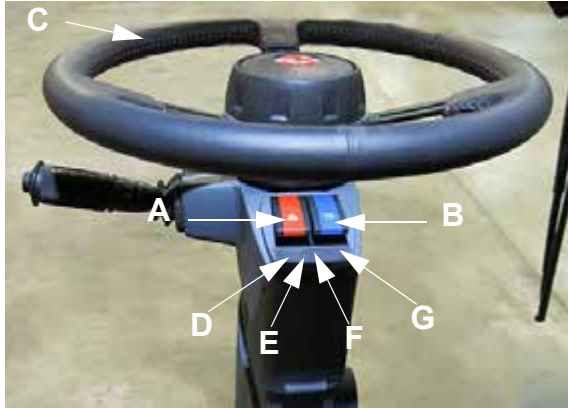

-Typical View

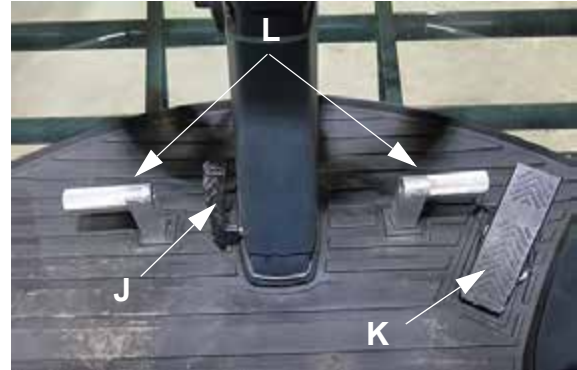

-Typical View



-Typical View



-Typical View



-Typical View

Hazard/Warning Lights Switch

The Hazard/Warning Lights (located on the front and rear of machine) are to be used at any time, day or night, that you are traveling on a public roadway, unless prohibited by law.

NOTE: The machine's drive state must be in Road Mode to activate the Hazard/Warning Lights.

NOTE: The Hazard/Warning Lights are tied to battery power and will operate when the machine is off. The flashers are disabled in Field Mode.

NOTE: The Hazard/Warning Light Flashers are also activated with the corresponding turn signal.

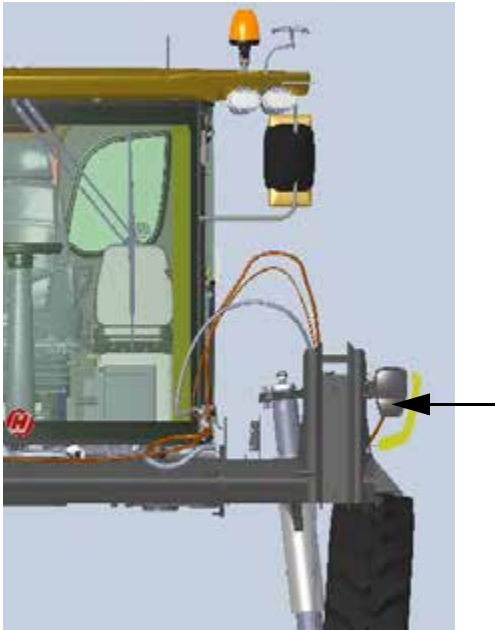

Front Hazard/Warning Light Flashers (2)
-Typical View

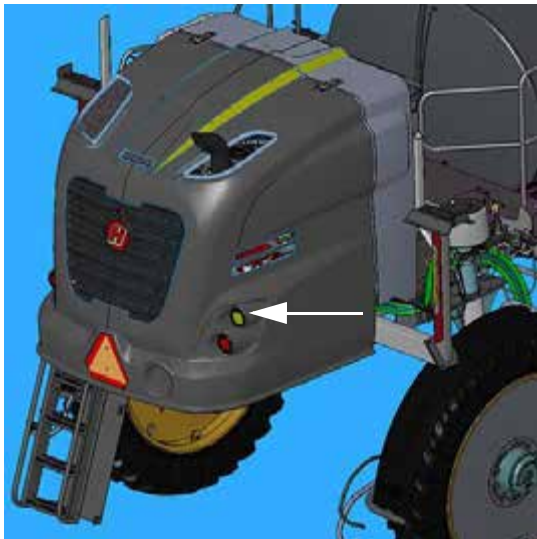

Rear Hazard/Warning Light Flashers (2)
-Typical View

To activate the Hazard/Warning Lights:

- Press the Hazard/Warning Lights Switch (located on steering column) in the DOWN (On) position to activate.
- Press the Hazard/Warning Lights Switch in the UP (Off) position to deactivate.

NOTE: The Rotating Beacons (located on each side of cab roof) also become active when the Hazard/Warning Lights Switch is depressed. Refer to

“Rotating Beacons” provided in the Safety and Precautions Section elsewhere in this manual for further information.



Hazard/Warning Lights Switch
(Located on steering column)
-Typical View

Highway Running Lights Switch (Headlights)

The Highway Running Lights (located on the front and rear of machine) are to be used when traveling on a public roadway at night.

NOTE: The Highway Running Lights operate in both Road and Field Mode.



Highway Running Lights (2)
-Typical View

The two rear red taillights are activated any time that the headlights are on.

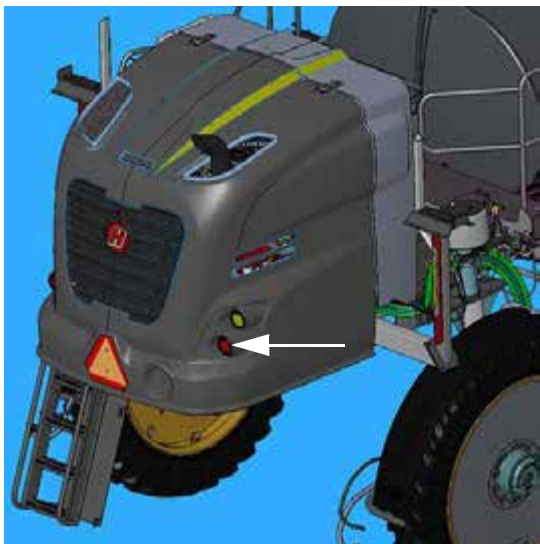

Rear Taillights (2)
-Typical View

To activate the Highway Running Lights:

- Press the Highway Running Lights Switch (located on steering column) in the DOWN (On) position to activate.
- Press the Highway Running Lights Switch in the UP (Off) position to deactivate.

NOTE: The Highway Running Lights Indicator (located near the steering wheel) will illuminate when activated.



Highway Running Lights Switch
(Located on steering column)
-Typical View

NOTE: Highway Running Lights are enabled when the key is in the ON position. However, prolonged use of these lights without the engine running is not recommended.

Steering Wheel Telescope Adjust

The Steering Wheel Telescope Adjust allows movement of the upper portion of the steering column to best suit your driving needs.

- To adjust the steering wheel, lift the Steering Wheel Telescope Adjust Handle (located on the right-hand side of the steering column) UP to loosen enough to freely move the steering wheel.



Steering Wheel Telescope Adjust Handle
(Located on the right-hand side of steering column)
-Typical View

- With the handle loosened, adjust steering wheel to desired position. While holding the wheel in position, release the Steering Wheel Telescope Adjust Handle to lock into place.

Steering Column Tilt Adjust (Knee Angle)

The Steering Column Tilt Adjust allows you to angle the top section of the steering column to the position that best suits your comfort needs.

To tilt top section of steering column down:

- Lift and hold the Steering Column Tilt Adjust Button (located on the left-hand

side of the steering column) in the UP position.



Steering Column Tilt Adjust Button
(Located on the left-hand side of the steering column)
-Typical View

- While maintaining the Steering Column Tilt Adjust Button in the upward position, pull steering wheel BACKWARD (toward the operator).
- Release button when steering column is in the desired position.

To tilt top section of steering column up:

- Lift and hold the Steering Column Tilt Adjust Button (located on the left-hand side of the steering column) in the UP position.
- While maintaining the Steering Column Tilt Adjust Button in the upward position, allow steering wheel to move FORWARD (away from the operator).
- Release button when steering column is in the desired position.

Steering Column Release Pedal

 **CAUTION**

Ensure the steering wheel and steering column are in the locked position before attempting to operate the machine. Failure to comply may result in difficulty maintaining control of the machine.

The Steering Column Release Pedal is featured for ease of exiting and entering the cab.

- With your foot on the Steering Column Release Pedal (located on the lower left-hand side of the steering column), push pedal DOWN and move the steering column to desired position.



Steering Column Release Pedal
(Located on the lower left-hand side of the steering column)
-Typical View

- To lock the steering column in desired position, remove your foot from the Steering Column Release Pedal while holding the steering column in place.
- Once the steering column has engaged into locked position, firmly move the steering column in either direction to ensure security.

Deceleration (Decel) Pedal

⚠ CAUTION

The Decel Pedal is NOT a brake. It is designated for speed reduction only.

When nearing an end row and speed deceleration is desired, press the Decel Pedal (located to the lower right-hand side of the steering column) to decrease speed.



Decel Pedal
(Located to the lower right-hand side of the steering column)
-Typical View

Refer to “Machine Display” provided elsewhere in this section for information on adjusting Decel Pedal minimum speed.

Operator Foot Pegs

Operator Foot Pegs are located on each side of the steering column to provide added comfort and stability while operating the machine.

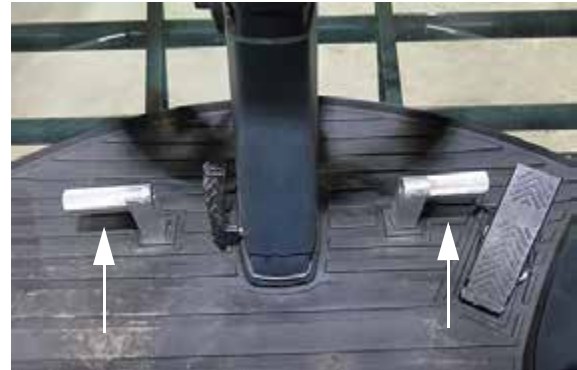

Operator Foot Pegs
(Located on each side of the steering column)
-Typical View

Horn

The Horn is sounded by pressing the Horn Button (located on the end of the turn signal lever) INWARD.



Horn Button
(Located on the end of the turn signal lever)
-Typical View

Windshield Washer

The Windshield Washer Button is located on the end of the turn signal lever. To apply washer fluid, press and hold button in the IN position. Release button when desired amount of fluid is dispensed.

NOTE: Ensure there is adequate amount of washer fluid in the windshield washer fluid reservoir (located behind the left-hand side of cab) before operating.



Windshield Washer Button
(Located on the end of
the turn signal lever)
-Typical View



Turn Signal Lever
-Typical View

NOTE: Steering column-mounted and Machine Display indicator lights will flash correspondingly when either turn signal is activated.

Windshield Wiper Speed

To increase or decrease Windshield Wiper speed, rotate the turn signal lever forward or backward to achieve Hi, Low, or Intermittent wiper speed.



Windshield Wiper Speeds
(Located on the turn signal lever)
-Typical View

High Beams (Brights)

- To turn the High Beams ON, push the turn signal lever (located on the left-hand side of the steering column) DOWN.
- To turn the High Beams OFF, push the turn signal lever UP.



High Beams
(Located on the turn signal lever)
-Typical View

Turn Signals

To activate the front and rear Turn Signals, move the Turn Signal Lever (located on the left-hand side of the steering column) FORWARD (away from operator) to signal a right turn, or BACKWARD (toward operator) to signal a left turn.

NOTE: The machine's drive state must be in Road Mode to activate the Turn Signals.

Side Console

*** Multi-Functional Switch. Refer to "Plow - Operation" provided elsewhere in this section for attachment switch functions.**

- (A) - Emergency Stop Switch
- (B) - Deluge Switch
- (C) - Heated Mirror Switch
- (D) - Boom Solution Valve Switches
- (E) - Rate Control Switches
- (F) - Pump Speed/Rate Switches
- (G) - Main Tank Valve Switch
- (H) - Solution Pump Switch
- (I) - Boom Extension Switches (Left/ Right Outer Fold)

- (J) - Ignition Switch
- (K) - Power Mirror Switch (if equipped)
- (L) - Hydrostatic Drive Control Handle
- (M) - Transom Switch (Up/Down)*
- (N) - Left-Hand Boom Switch*
- (O) - Right-Hand Boom Switch*
- (P) - Master Spray Switch*
- (Q) - End Row Management Switch
- (R) - Shift Up Switch
- (S) - Shift Down Switch
- (T) - Parking Brake Switch
- (U) - Throttle Switch
- (V) - Remote Stereo Controls
- (W) - 12V Power Ports
- (X) - Auxiliary 2 Audio Input Connection



-Typical View



-Typical View



-Typical View



-Typical View



-Typical View



-Typical View



E-Stop Switch
(Located on the side console)
-Typical View



-Typical View

Refer to the *Safety and Precautions* Section provided elsewhere in this manual for further information.

Deluge Switch

The Deluge Switch (located on the side console) is used to apply de-icer solution onto the exterior cab glass to aid in melting ice and frost.

- Press and hold the Deluge Switch in the UP position to dispense de-icer solution.
- Release the Deluge Switch when finished.

Emergency Stop (E-Stop)

The E-Stop Switch (located on the side console) provides a quick and positive method for stopping the engine in an emergency situation.

NOTE: DO NOT use this button for non-emergency stopping or as a parking brake.



Deluge Switch
(Located on the side console)
-Typical View

Refer to “Deluge System” provided in the *Miscellaneous Section* elsewhere in this manual for further information.

Heated Mirror Switch

The Heated Mirror Switch (located on the side console) is used to defrost your side-view mirrors to keep the mirror glass free from ice and snow.

- **To activate**, press the Heated Mirror Switch in the UP (On) position.
- **To deactivate**, press the Heated Mirror Switch in the DOWN (Off) position.



Heated Mirror Switch
(Located on the side console)
-Typical View

Boom Solution Valve Switches

The Boom Solution Valve Switches (located on the side console) each control a valve located on the boom or transom. The valves control the flow of the solution through the boom.



Boom Solution Valve Switches
(Located on the side console)
-Typical View

The boom is divided into sections, with the far left tip being the beginning of the first section. Each Boom Solution Valve Switch is equipped with an indicator light and will illuminate red when manually turned off.

Refer to the *Spray Systems Section* elsewhere in this manual for further information.

Rate Control Switches

The Rate Control Switches (located on the side console) control the rate in which solution is applied through the spray booms by either the rate controller (Enable) or operator-controlled spray rate (Manual).

NOTE: When both “MAN” and “ENABLE” Rate Control Switches are pressed, manual rate control is activated through the rate controller.



Rate Control Switches
(Located on the side console)
-Typical View

Refer to the *Spray Systems Section* elsewhere in this manual for further information.

Pump Speed/Rate Switches

The Pump Speed/Rate Switches (located on the side console) allow you to increase or decrease flow rate through the spray system.

NOTE: When the “MAN” Rate Control Switch is pressed, the Pump Speed/Rate Switches increase or decrease pump speed/application rate from the Hagie control system. When the “ENABLE” Rate Control Switch is

pressed (with either “MAN” active or inactive), a third party rate controller increases or decreases pump speed/application rate.



Pump Speed/Rate Switches
(Located on the side console)
-Typical View

Refer to the *Spray Systems Section* elsewhere in this manual for further information.

Main Tank Valve Switch

The Main Tank Valve Switch (located on the side console) controls the solution tank valve. This switch must be in the ON (Open) position for spray application.



Main Tank Valve Switch
(Located on the side console)
-Typical View

Refer to the *Spray Systems Section* elsewhere in this manual for further information.

Solution Pump Switch

The Solution Pump Switch (located on the side console) is used to turn the Solution Pump ON/OFF.



Solution Pump Switch
(Located on the side console)
-Typical View

NOTE: Leaving the Solution Pump Switch in the ON position can cause the pump to run continuously, which may result in system damage.

Refer to the *Spray Systems Section* elsewhere in this manual for further information.

Boom Extension Switch (Outer Fold)



⚠ WARNING

When operating or positioning the booms, observe the following safety precautions to avoid serious injury or death:

- Select a safe area before folding/unfolding booms.
- Clear area of personnel.
- Check for overhead obstructions.
- Do not fold/unfold booms near power lines. Contact with power lines can result in serious injury or death.



⚠ CAUTION

When operating or positioning the booms, observe the following safety precautions to avoid injury or equipment damage.

- Do not fold/unfold boom extensions when main boom is in cradle.
- Do not operate sprayer with one boom wing out of cradle and the other boom wing in cradle.
- Do not transport machine without booms folded and in cradle.

The Boom Extension Switch (located on the side console) is used to extend or retract the outer boom extensions.



Boom Extension Switch
(Located on the side console)
-Typical View

Refer to the *Spray Systems Section* elsewhere in this manual for further information.

Ignition Switch

The Ignition Switch (located on the side console) has three positions - OFF, ON, and START. Before engaging the starter, turn the ignition key to the ON position and wait for the “wait to start” message to disappear on the Machine Display.

NOTE: The parking brake must be engaged before engaging the starter.



Ignition Switch
(Located on the side console)
-Typical View

- **To engage the starter**, turn the key to the START position and hold momentarily until the engine engages. If the engine does not engage after 15 seconds, turn the key to the OFF position.

NOTE: Constant cranking of the starter will cause damage to the battery and starting system.

Power Mirrors

-If Equipped

Your machine may be equipped with Power Mirrors for your operating convenience.

- Press the L/R Lever in the “L” position to adjust the LEFT mirror or in the “R” position to adjust the RIGHT mirror.
- Press the Adjust Switch to adjust the corresponding mirror to desired position.



Power Mirror Switch
(Located on the side console)
-Typical View

Hydrostatic Drive Control Handle

*** Multi-Functional Switch. Refer to “Plow - Operation” provided elsewhere in this section for attachment switch functions.**

The Hydrostatic Drive Control Handle controls various functions of the machine and attachments. It is used to control the direction of the machine and the speed in which it travels. It is also used to control the spray booms, end row management, master spray, and shift up/down speeds.



Front View

Side View

Hydrostatic Drive Control Handle
-Typical View

Refer to the *Engine and Drive Systems and Spray Systems Sections* elsewhere in this manual for further information.

Left and Right-Hand Boom Switches*

The Left and Right-Hand Boom Switches (located on the Hydrostatic Drive Control Handle) are used to raise, lower, extend, and retract the spray booms.

End Row Management Switch

The End Row Management Switch (located on the Hydrostatic Drive Control Handle) is a programmable switch that enables various functions (i.e. All-Wheel Steer, Auto Steer, and Master Spray) when the switch is depressed.

NOTE: End Row Management functions are disabled in Road Mode.

Refer to “Machine Display” provided elsewhere in this section for programming information.

Transom Switch - Up/Down*

The Transom Switch (located on the Hydrostatic Drive Control Handle) is used to raise and lower the main lift.

Master Spray Switch*

The Master Spray Switch (located on the Hydrostatic Drive Control Handle) activates the boom solution valves.

Shift Up/Down Switches

The Shift Up/Down Switches (located on the Hydrostatic Drive Control Handle) are used for speed range selection.

Refer to “Hydrostatic Drive” provided in the *Engine and Drive Systems Section* elsewhere in this manual for further information.

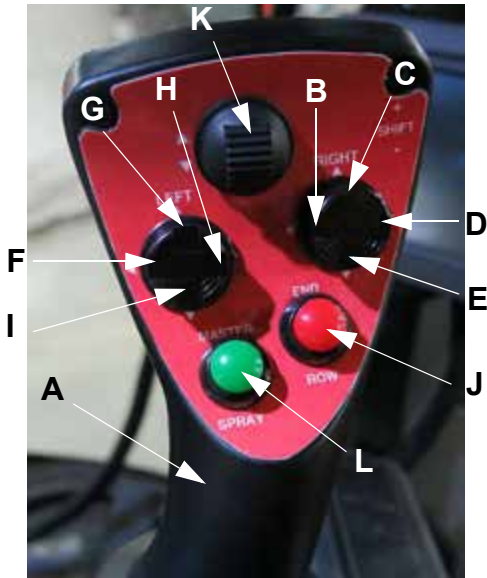

- (A) - Hydrostatic Drive Control Handle
- (B) - Right-Hand Boom IN
- (C) - Right-Hand Boom UP
- (D) - Right-Hand Boom OUT
- (E) - Right-Hand Boom DOWN
- (F) - Left-Hand Boom OUT
- (G) - Left-Hand Boom UP
- (H) - Left-Hand Boom IN
- (I) - Left-Hand Boom DOWN
- (J) - End Row Management Switch
- (K) - Transom Switch
- (L) - Master Spray Switch
- (M) - Shift Up Switch
- (N) - Shift Down Switch

Parking Brake Switch



Do not engage the parking brake while the machine is moving. Failure to comply may result in personal injury and machine damage.

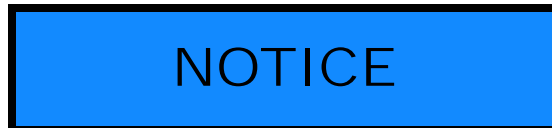

The parking brake is not intended for normal or emergency stopping.

The Parking Brake Switch (located near the Hydrostatic Drive Control Handle) is used to engage/disengage the parking brake, as well as extend/retract the ladder.



Parking Brake Switch
(Located near the Hydrostatic Drive Control Handle)
-Typical View

Refer to “Hydrostatic Drive” provided in the *Engine and Drive Systems Section* elsewhere in this manual for further information.

Throttle Switch

The Throttle Switch (located near the Hydrostatic Drive Control Handle) is used to control engine speed (RPM).

NOTE: The operator may select throttle setting by operating the Throttle Switch. However, engine speed is also controlled by movement of the Hydrostatic Drive Control Handle.



Throttle Switch
(Located near the Hydrostatic Drive Control Handle)
-Typical View

NOTE: Engine speed can range between 850 and 2500 RPM in both Road and Field Mode.

The Throttle Switch works with a timer to tell the engine how fast to run. The longer the operator holds the switch in either direction (press UP/“rabbit icon” to increase the speed, press DOWN/“turtle icon” to decrease the speed), the more the engine will speed up or slow down.

Remote Stereo Controls

Your machine is featured with Remote Stereo Controls (located near the Hydrostatic Drive Control Handle) for your convenience.

- **Volume Button** - Press button UP or DOWN to increase or decrease stereo sound.
- **Mute Button** - Press button to silence/ mute stereo sound. Press again to resume sound.
- **Source Button** - Press button to toggle through the source selections (Radio, CD, MP3, etc.)

NOTE: The selected source will be shown on the stereo display.

- **Seek Button** - Press button UP or DOWN to toggle through the radio channels or CD/MP3 selections.



Remote Stereo Controls
(Located near the Hydrostatic Drive Control Handle)
-Typical View

- Volume Button
- Mute Button
- Source Button
- Seek Button

Power Ports (12-Volt)

Four (4) Power Ports (three located on the inward side console panel and one located along the lower left-hand side of operator’s seat) are provided for the connection of additional items (such as radios and computer equipment).

NOTE: The Power Ports are not intended for the permanent connection of additional systems to the sprayer.

Auxiliary Audio Input Connection (Aux 2)

The Aux 2 Audio Input Connection (located on the inward side console panel) allows you to connect a personal i-Pod or MP3 player.

NOTE: An Aux 1 Audio Input Connection is located on the stereo/radio.



12V Power Ports and
Aux 2 Audio Input Connection
(Located on the inward side console panel)
-Typical View



-Typical View



-Typical View

Overhead Monitors and Controls

- (A) - Courtesy Light/Interior Work Light
- (B) - Stereo
- (C) - Climate Controls
- (D) - Spray System Console
- (E) - Machine Display
- (F) - Belly Camera Monitor
- (G) - Machine Gauges
- (H) - Section Indicator Display
- (I) - Side Wipers



-Typical View



-Typical View



-Typical View



-Typical View



-Typical View



Interior Work Light Switch
-Typical View

Stereo

The Stereo in your cab is featured with an AM/FM Tuner, Weatherband Broadcasting, CD Player, MP3 Player, USB/iPod Controls, and Bluetooth®.



-Typical View

- Select/Volume Knob
- Disp Button



- Back Button
- Preset Buttons (1-6)

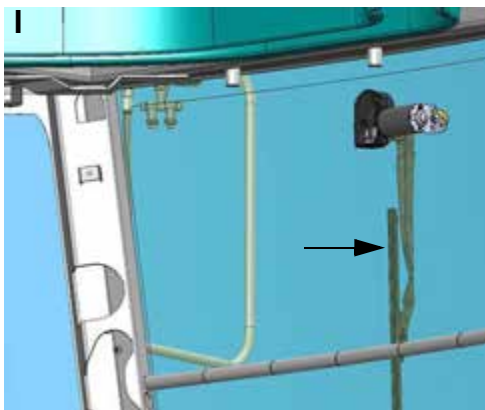

-Typical View

Courtesy Light/Interior Work Light

The Courtesy Light comes on automatically when the cab door is opened.

The Interior Work Light is activated by manually by pressing the Interior Work Light Switch (located on the light housing).

- Press switch UP to turn interior “white” light ON.
- Press switch DOWN to turn interior “red” light ON.
- Press switch in the mid-position to turn OFF.

Bluetooth Pairing (Registration)

1. Press desired Preset Button (1-6) to select a registration number assigned to the Bluetooth device to be registered.

NOTE: Up to eight (8) devices of memory registered with Preset Buttons.

- (1-5) - Selects a registration number (1st page: 1-5, 2nd page: 6-8).
 - (6) - Turns the registration pages (Registration No. 6 - press 6, then press 1; Registration No. 7 - press 6, then press 2; Registration No. 8 - Press 6, then press 3).
2. Press and hold the selected Preset Button for 2+ seconds until “Pairing” flashes on the display.
 3. Quickly release the Preset Button and press the Select/Volume Knob until “Waiting” appears on the display.
 4. Operate your Bluetooth device to input the PIN number for connection. Once pairing/registration is successful,

the registered Bluetooth device can automatically communicate with this unit.

NOTE: Default PIN number = “0000”.

- The text display of Bluetooth device name and telephone directory on this unit is only supported with English characters. Other languages and non-displayable characters/symbols will be converted into an asterisk (*).
- If registration is not successfully completed within one (1) minute, “TIME OUT” will appear and the screen for registration number selection resumes.
- If registration fails due to a mismatched PIN number, “PAIR ERR” will appear and the screen for registration number selection resumes.
- Depending on the communication status, it may take 5 to 40 seconds for device connection.

NOTE: Press the Disp Button at any time to exit waiting status.

Music Mode Activation

- Press and hold the Back Button for 2+ seconds.

NOTE: If the Back Button is held down for 2+ seconds again, phone mode is activated.

Refer to the Stereo manufacturer’s operation guide for complete operating instructions and programming information.

Climate Controls

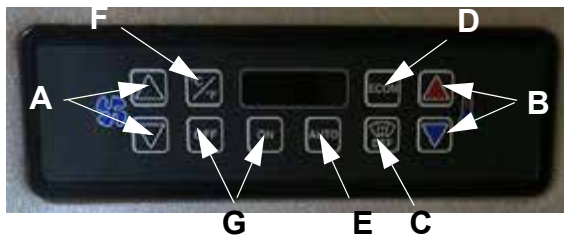

-Typical View

Fan Up/Down (A)

The Fan Up/Down Switches control the fan speed up or down in 11 increments and overrides the automatic fan speed control.

- Press desired switch UP to increase fan speed, or DOWN to decrease fan speed.

- The Digital Display indicates the fan speed setting as a percentage, or “HI” when maximum fan speed is obtained, or “LO” when minimum fan speed is obtained.

NOTE: The Digital Display will return to the normal display five seconds after either key is depressed. The set point fan speed is maintained until it is changed, or until the Auto Mode Switch is depressed.

Temperature Up/Down (B)

The Temperature Up/Down Switches increments the cab set point temperature.

- Press desired switch UP to increase temperature, or DOWN to decrease temperature.

Defrost (C)

The Defrost Switch energizes the A/C system to allow for rapid cab dehumidification.

- Press the Defrost (DEF) Switch to turn ON.

NOTE: An indicator light will illuminate when defrost mode is active.

Economy Mode (D)

Economy Mode uses fresh air, fan speed, and water valve control to maintain the set point temperature. When active, A/C function is disabled.

- Press the Econ Switch to turn ON.
- Press the Econ Switch again to return the system back to normal operation.

NOTE: An indicator light will illuminate when Economy Mode is active.

Auto Mode (E)

Auto Mode allows the system to function in fully automatic temperature control mode, including automatic fan speed control. The system will adjust the fan speed to the lowest setting required to maintain cab set point temperature.

- Press the Auto Switch to turn ON and OFF.

NOTE: An indicator light will illuminate when auto mode is active.

Cab Temperature (F)

- Press the Cab Temp Switch to display set point on the Digital Display.

NOTE: Press the Cab Temp Switch and toggle between celsius (C) and fahrenheit (F) temperatures.

NOTE: Current cab temperature will be displayed for five seconds, then will return to the set point temperature display.

On/Off (G)

- The On/Off Switches power the cab heater/air conditioner systems ON or OFF.

NOTE: An LED numeric display is illuminated when the unit is turned on. The Digital Display will show the current set point temperature.

Cab Vents

Your cab is equipped with adjustable vents. Rotate to desired position, or individually turn on or off with the directional fins.



Cab Vent
-Typical View

Spray System Console

The spray system is controlled by the Spray System Console and the Solution Pump Control Valve. The system receives data and automatically makes adjustments based on the target rate of application set by the operator.



Spray System Console
-Typical View

Refer to the manufacturer's operation manual for complete operating instructions and programming information.

Machine Display

The Machine Display in your cab is the central control center of the machine. It controls many of the machine's electronically-driven functions (e.g. machine drive, AWS, attachment operation, tread adjustment, spray systems, lights, diagnostics, etc.)



Machine Display
-Typical View

Refer to "Machine Display" provided elsewhere in this section for a complete list of features and operating instructions.

Belly Camera Monitor

The Belly Camera Monitor in your cab allows you to view the ground beneath the machine while operating. The belly camera is located beneath the front end of machine and may be adjusted to suit your viewing needs.



Belly Camera Monitor
-Typical View

Refer to the manufacturer's operation manual for further information.

Machine Gauges

Machine Gauges are located on the A-post in your cab and are conveniently placed for viewing machine diagnostics.



Machine Gauges
(Located on cab A-post)
-Typical View

- Tachometer (RPM Gauge)
- Fuel Gauge
- Engine Coolant Gauge
- Aftertreatment Gauge

Section Indicator Display

The Section Indicator Display allows you to view system status for the following:

- (1) - Master Spray Indicator (illuminates when ON).
- (2) - Fence Row Indicators (illuminate when ON).
- (9) - Spray Section Indicators (illuminate when OFF).
- (1) - Rear Wheel Nozzle Indicator (illuminates when ON).

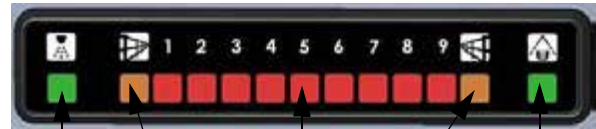

- Master Spray
- Left Fence Row
- Spray Section
- Right Fence Row
- Rear Wheel Nozzle

Section Indicator Display
-Typical View

Refer to the *Spray Systems Section* elsewhere in this manual for further information.

Side Wipers

Side Wipers are located on the left and right-hand side of cab. Press the corresponding Side Wiper Switch (located on each interior side wiper assembly) in the UP (On) position to activate. Press the switch in the DOWN (Off) position to deactivate.

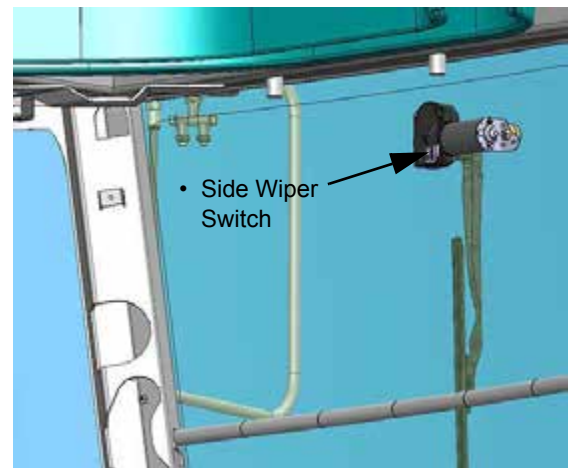

Side Wiper Assembly
(Located on the left and
right-hand side of cab)
-Typical View

Lighting

NOTE: See Front Console components discussed earlier in this section for information on Hazard/Warning Lights and Highway Running Lights.

Field Lights

The Field Lights (located on the front of cab) are for use when operating in the field after dark and are turned on/off through the Machine Display.

NOTE: Turn Field Lights OFF before entering a public roadway.

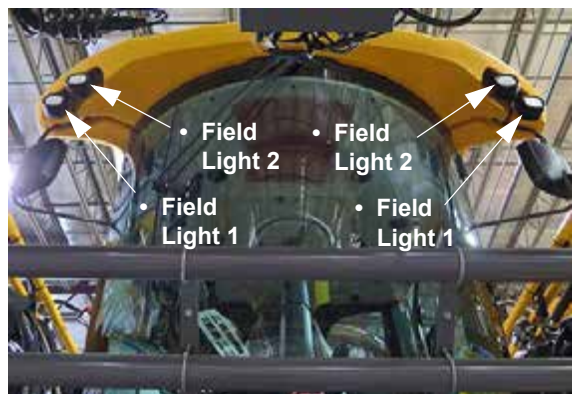

Field Lights (4)
(Located on the front of cab)
-Typical View

NOTE: The ignition key must be in the ON position to operate the Field Lights.

Refer to “Machine Display” provided elsewhere in this section for operating instructions.

Work Lights

The Work Lights (located on each boom cradle) are for use when operating in the field after dark and are turned on/off through the Machine Display.

NOTE: Turn Work Lights OFF before entering a public roadway.



Work Lights (2)
(Located on each boom cradle)
-Typical View

NOTE: The ignition key must be in the ON position to operate the Work Lights.

Refer to “Machine Display” provided elsewhere in this section for operating instructions.

Attachment Lights

The Attachment Lights (located on the front of transom) are for use when operating in the field after dark and are turned on/off through the Machine Display.

NOTE: Turn the Attachment Lights OFF before entering a public roadway.

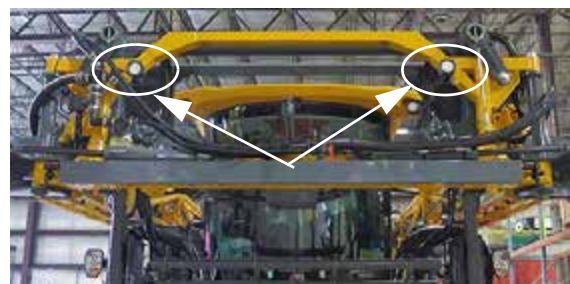

Attachment Lights (2)
(Located on the front of transom)
-Typical View

NOTE: The ignition key must be in the ON position to operate the Attachment Lights.

Refer to “Machine Display” provided elsewhere in this section for operating instructions.

Cab Filtration

RESPA® Cab Filter

The cab is featured with a dust and aerosol filtration system to provide continuous positive pressure in the cab by reducing exposure to harmful particulates. A 3” (7.6 cm) air intake pipe is used to reduce excessive fresh air intake in the cab for improved cooling.

NOTE: The filtration system will activate automatically approximately 10 seconds after machine start-up.



Cab Filtration System
(Located on the right-hand side of the exterior cab)
-Typical View

An indicator light (located on the Machine Display Home Page) will appear if insufficient cab air pressure should occur.

NOTE: The Insufficient Cab Air Pressure Indicator will appear each time the machine is started due to the initial activation delay. The indicator will disappear once the cab becomes pressurized.

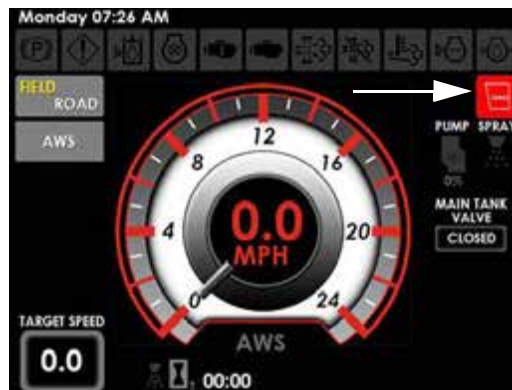

Insufficient Cab Air Pressure Indicator
(Located on the Machine Display Home Page - Road or Field Mode)

Refer to “Service - Filters” provided in the *Maintenance and Storage Section* elsewhere in this manual for filter replacement information.

Charcoal/Recirculation Filters

Your cab is featured with a Charcoal Filter (located behind the exterior service panel on the right-hand side of cab), which eliminates hazardous chemicals from the operator’s station. In addition, a Recirculation Filter (accessible after the Charcoal Filter has been removed) is provided to cleanse air inside the cab, keeping the operator’s environment fresh.



Charcoal Filter
(Located behind the exterior service panel on the right-hand side of cab)
-Typical View



Recirculation Filter
(Located along the right-hand
side of service compartment)
-Typical View

** View shown with charcoal filter removed*

Refer to “Service - Filters” provided in the *Maintenance and Storage Section* elsewhere in this manual for further information on filter maintenance.

Additional Features

Portable Electric Cooler

-If Equipped

Your machine may be equipped with a Portable Electric Cooler (located beneath the Instructor Seat) for your personal convenience. A 12-volt connection outlet is provided along side of the operator’s seat.

MACHINE DISPLAY

(Typical View - Your machine may vary in appearance, depending on available equipment)

The Machine Display is the central control center of the machine. It controls many of the machine’s electronically-driven functions, such as:

- Machine Drive
- All-Wheel Steer (if equipped)
- Attachment Operation
- Spray System
- Reversible Fan
- Backup Video Camera
- Exterior Lights

- Diagnostics



Machine Display
-Typical View

Machine Display Page Settings

The Machine Display is featured with six display pages:

- Home Page (Road Mode)
- Home Page (Field Mode)
- Auxiliary Controls Page
- Video Camera Page
- Machine Diagnostics Page
- Settings Page

Press the corresponding Page Display Button (located on the right-hand side of the Machine Display) to navigate through the display pages.



Page Display Buttons
(Located on the right-hand
side of the Machine Display)



Home Page (Road Mode)



Machine Diagnostics Page



Home Page (Field Mode)



Settings Page



Auxiliary Controls Page



Video Camera Page

Speed Settings and Machine Adjustments

Throughout this manual, various adjustments are made through the Field/Road Speed Settings and Machine Adjustments (located on the Settings Page).

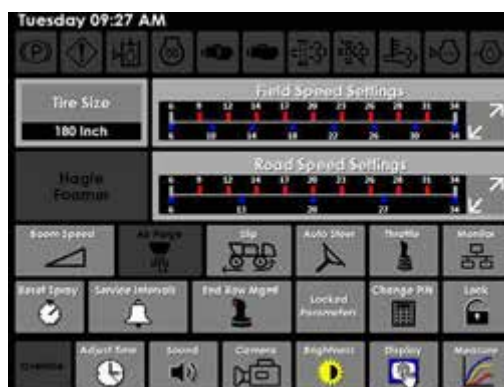

Speed Settings and Machine Adjustments
(Located on the Settings Page)

NOTE: The machine must be stationary before allowing certain Speed Setting and Machine Adjustments.

Field/Road Speed Settings

- First Range Top Speed
- Last Range Top Speed
- Number of Ranges
- AWS Shutoff Speed (Field Speed Settings only)

Machine Adjustments

Slip (Traction Control)

- Slip Percent
- Slip Destroke

CAN Monitor

- Enable CAN1
- Enable CAN2
- Enable CAN3

Display

- Units (Standard/Metric)
- Animations
- Gauge Color
- Language

Brightness

- Day Time Brightness
- Night Time Brightness
- Transition Settings

Camera

- Backup Camera
- Aux Camera 1
- Aux Camera 2
- Edit Overlay
- Settings
- Flip Vertical
- Flip Horizontal

Throttle

- Throttle Control Slope
- Throttle Up Ramp
- Throttle Max
- Decel Pedal Min Speed

End Row Management

- All Wheel Steer (if equipped)
- Master Spray

Tire Size

- Rolling Circumference

Service Intervals

- 50-Hour Interval
- 100-Hour Interval
- 500-Hour Interval
- Hydraulic Filter
- Hydraulic Oil
- Engine Oil

Machine Setting Security

To Lock Machine Settings

- Press the Locked Parameters Button (located on the Settings Page).



Locked Parameters Button
(Located on the Settings Page)

- On the “Change Locked Parameters” screen, press the Up/Down Arrow Buttons until desired setting is displayed.

NOTE: Single arrow buttons toggle up/down one page. Double arrow buttons toggle to either the first or last page.



Change Locked Parameters Screen

- Press the “lock icon” next to desired setting to the LOCKED position.
- Press OK.
- Press the Lock Button (located on the Settings Page).
- Press OK to confirm locked settings.

NOTE: When the Lock Button is pressed, the Locked Parameters and Change Pin Buttons will disappear. These

buttons will re-appear when the Lock Button is pressed and the correct pin number is entered.

NOTE: Default Pin Number is “50525”.

To Unlock Machine Settings

- Press the “red illuminated” Lock Button (located on the Settings Page).

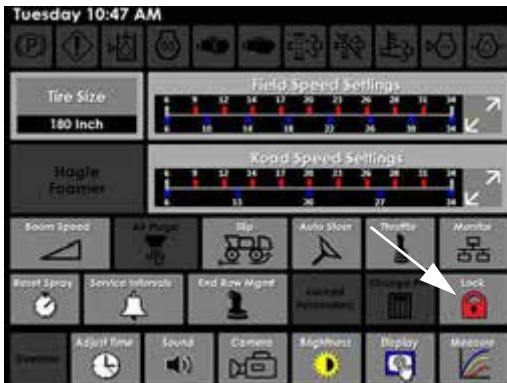

Lock Button
(Located on the Settings Page)

- On the “Enter Lock Password” screen, enter pin number.
- Press UNLOCK.

To Change Pin Number

- Press the Change Pin Button (located on the Settings Page).

NOTE: Press the Lock Button and enter current pin number to enable the “Change Pin Button” to re-appear on the display.

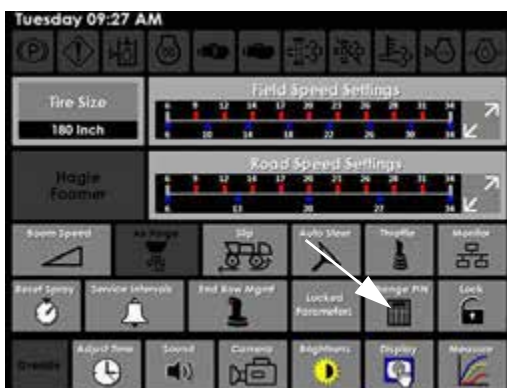

Change Pin Button
(Located on the Settings Page)

- On the “Set New Password” screen, enter newly-selected 5-digit pin.

- Press OK.

NOTE: A “Password Changed” confirmation will appear when complete.

Machine Display Indicators

To alert the operator of certain operations or when a machine system requires attention, various Machine Display Indicators are located on the top of each display page and illuminate to inform you of a specific situation.

- Parking Brake ON
- Machine Warning
- Check Engine
- Stop Engine
- Exhaust System Cleaning
- Engine Cleaning Stop
- High Exhaust Temperature (HEST)
- Low Diesel Exhaust Fluid (DEF) (Tier 4 Final Engines)
- Low Engine Oil Pressure
- Low Engine Coolant Level
- Grid Heater ON
- Low Hydraulic Oil Level
- Insufficient Cab Air Pressure

Warning Light Indicator

When a system error requires attention, a Machine Warning Light Indicator (located on the top left-hand side of each display page) will illuminate. This indicator will be accompanied by a warning buzzer and a warning message telling you what the error is and what should be done to correct it.

NOTE: The error message may be cleared by pressing OK or ACKNOWLEDGE and the warning buzzer may be silenced by pressing the Sound Button (located on the Settings Page) to the OFF (red illuminated “disabled”) position. However, the Warning Light Indicator will remain illuminated until the issue has been corrected.



Warning Light Indicator
(Located on the top left-hand side of each display page)

Warning Buzzer

The Warning Buzzer alerts the operator when a system fault is detected and requires immediate attention. To silence the buzzer, press the Sound Button (located on the Settings Page) to the OFF (red illuminated “disabled”) position.

NOTE: The Sound Button will reset to the ON (enabled) position each time the ignition key is cycled.

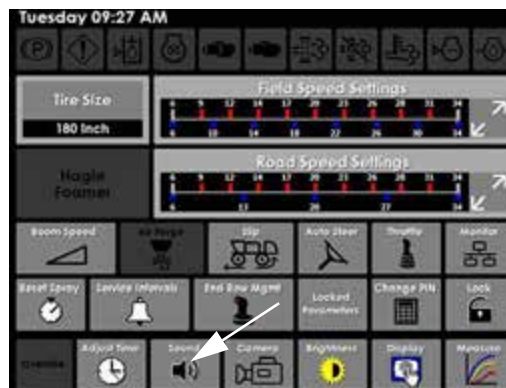

Sound Button
(Located on the Settings Page)

Lighting Adjustment

(Day Time/Night Time)

To Adjust the Display, Section Keypad, Side Console Switches, and Gauge Post Lighting

- Press the Brightness Button (located on the Settings Page).

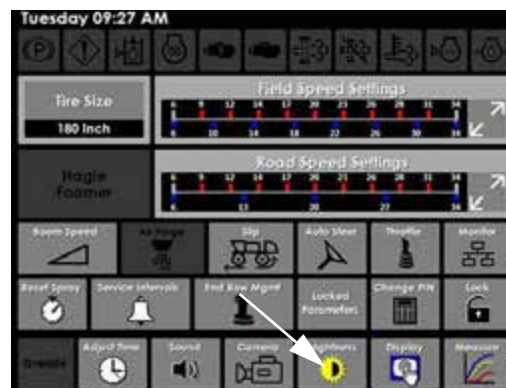

Brightness Button
(Located on the Settings Page)

- On the “Brightness” screen, press desired “Day Time” or “Night Time” Button.

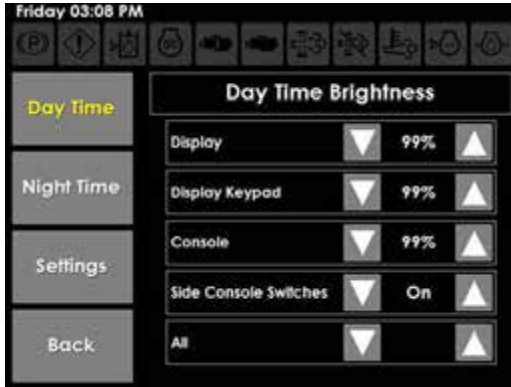

Brightness Screen

- Adjust corresponding day time and/or night time Display, Section Keypad, Side Console Switches, Gauge Post, or All brightness levels UP or DOWN to desired setting.
- Press BACK when finished.

To Set Automatic Night Time/Day Time Transition Brightness

NOTE: Brightness levels must be manually set (as previously described) before setting automatic transition brightness.

- On the “Brightness” screen, press the Settings Button.
- On the “Transition Settings” screen, press EDIT (next to Enable Time Transition).



Transition Settings Screen

- Select YES.
- Press OK.
- Press EDIT (next to Night Time Hour Start).

- Enter desired value (time of day that night time brightness will activate).
- Press OK.
- Press EDIT (next to Night Time Minute Start).
- Enter desired value (time of day that night time brightness will activate).
- Press OK.

NOTE: Repeat in the same manner for adjusting Day Time Hour and Minute Start).

- Press OK.
- Press BACK when finished.

Display Units/Animations/Gauge Color/Language

Units

To change units of measure:

- Press the Display Button (located on the Settings Page).

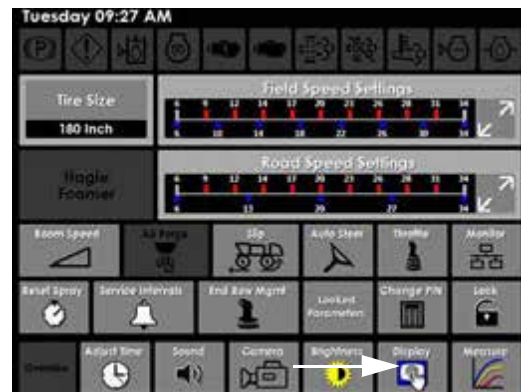

Display Button
(Located on the Settings Page)

- On the “Display Settings” screen, press EDIT (next to Units) and select one of the following options:
 - Standard
 - Metric (Bar)
 - Metric (KPA)



Display Settings Screen

- Press OK.

Animations

- Press the Display Button (located on the Settings Page).
- On the “Display Settings” screen, press EDIT (next to Animations) and select “Yes” to enable animations, or “No” to disable animations.
- Press OK.

Gauge Color

- Press the Display Button (located on the Settings Page).
- On the “Display Settings” screen, press EDIT (next to Gauge Color) and select desired color.
- Press OK.

Language

- Press the Display Button (located on the Settings Page).
- On the “Display Settings” screen, press EDIT (next to Language) and select preferred language.



Language Selection Screen

- Press OK.

NOTE: Press and hold the Settings Page Display Button (located on the right-hand side of the Machine Display) for approximately 10 seconds to navigate directly to the “Language Selection” screen.

Date and Time

The date and time is located on the upper left-hand corner of each display page and is set to central-standard time.

To Change Date or Time

- Press the Adjust Time Button (located on the Settings Page).

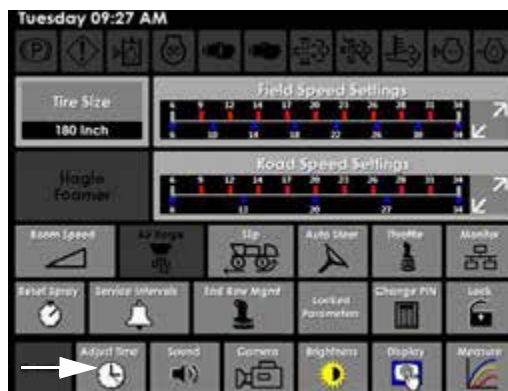

Adjust Time Button
(Located on the Settings Page)

- On the “Adjust Date and Time” screen, enter new date and time by pressing the corresponding Up/Down Buttons.



Adjust Date and Time Screen

- Press OK.

Machine Information

Machine information, such as total engine/machine hours, software version, attachment information, and machine serial number are located on the Machine Information screen.

- Press the Machine Information Button (located on the Machine Diagnostics Page) to view information.

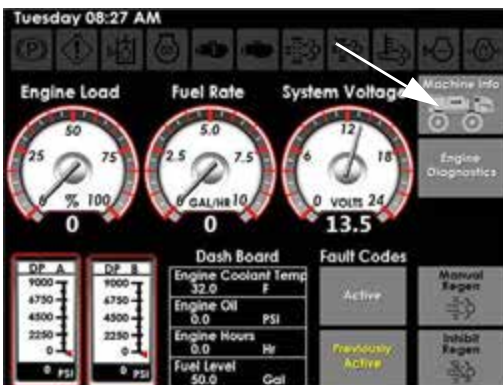

Machine Information Button
(Located on the
Machine Diagnostics Page)

Software Information

The Machine Display Software Information provides information on current software used and the date that it was released for the following:

- Primary Hydraulic Controller
- Secondary Hydraulic Controller
- Primary Display Controller

Attachment Information

The machine recognizes which attachment (e.g. 90-ft. Boom, Snow Plow, or Flail) is connected to the machine and is displayed on the Machine Information screen.

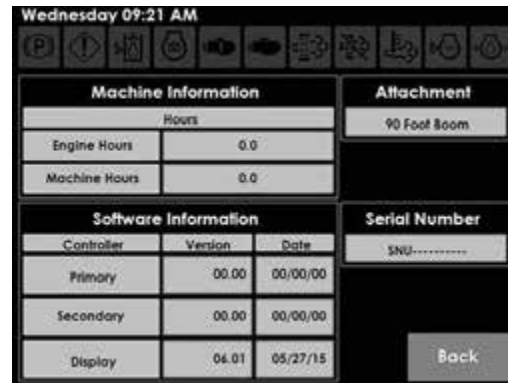

Machine Information Screen

Exterior Lights

(Field Lights, Work Lights, and Attachment Lights)

The exterior machine lights are activated through the Auxiliary Controls Page.

NOTE: The light buttons will illuminate when in the ON position.

Field Light Buttons

The Field Lights are located on front of the cab.

- Press the Field Lights Button(s) (FLD1 and/or FLD2) to turn Field Lights ON. Press button(s) again to turn Field Lights OFF.



Field Light Buttons
(Located on the Auxiliary Controls Page)

NOTE: Turn Field Lights OFF before entering a public roadway.

NOTE: The ignition key must be in the ON position to operate the Field Lights.

Work Lights Button

The Work Lights are located on each of the boom cradles.

- Press the Work Lights Button (WRK) to turn Work Lights ON. Press button again to turn Work Lights OFF.



Work Lights Button
(Located on the Auxiliary Controls Page)

NOTE: Turn Work Lights OFF before entering a public roadway.

NOTE: The ignition key must be in the ON position to operate the Work Lights.

Attachment Lights Button

The Attachment Lights are located on the front of the transom.

- Press the Attachment Lights Button (ATCH) to turn Attachment Lights ON. Press button again to turn Attachment Lights OFF.



Attachment Lights Button
(Located on the Auxiliary Controls Page)

NOTE: Turn Attachment Lights OFF before entering a public roadway.

NOTE: The ignition key must be in the ON position to operate the Attachment Lights.

All Lights Button

- Press the All Lights Button (ALL) to turn on all lights (Field, Work, and Attachment) ON. Press button again to turn all lights OFF.



All Lights Button
(Located on the Auxiliary Controls Page)

NOTE: The ignition key must be in the ON position to operate the Exterior Lights.

Video Camera

Your machine is equipped with a Video Camera for your convenience when operating the machine in reverse and is located on the rear of the sprayer.

NOTE: A separate Belly Camera Monitor is provided in the cab to view the ground beneath the machine while operating. The belly camera is mounted on the bottom of the chassis and is angled to view the snow plow brushes.

- On the Video Camera Page, press desired camera display to view in half-screen mode. Press again to view in full-screen mode.

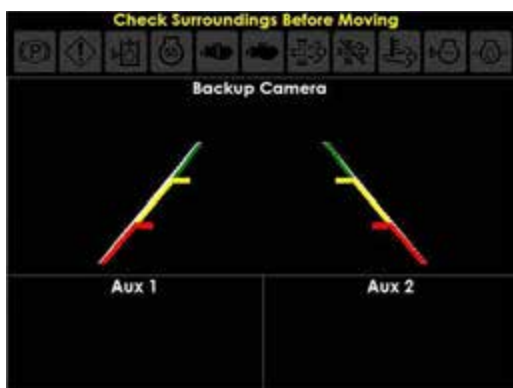

Video Camera Page

NOTE: Two additional video camera input connections (located beneath cab - remove front panel to access) are provided for the installation of add-on video camera(s).

Refer to “Video Camera Input Connections” provided in the Electrical Systems Section elsewhere in this manual for further information.

Video Camera Settings

To Adjust Video Camera Settings

- Press the Camera Button (located on the Settings Page).

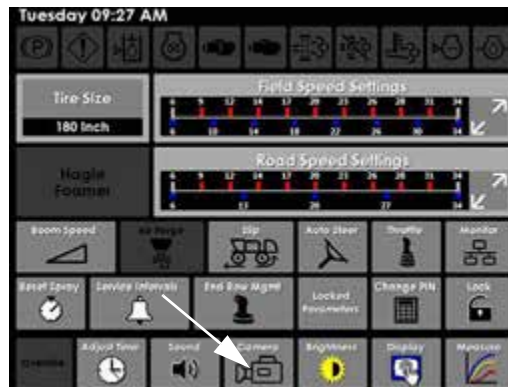

Camera Button

(Located on the Settings Page)

- On the “Camera Settings” screen, select either BACKUP CAMERA, AUX CAMERA 1, or AUX CAMERA 2.

NOTE: Press the “Flip Vertical” or “Flip Horizontal” Button to rotate object to desired position.



Camera Settings Screen

Edit Overlay

- Press the Edit Overlay Button (located on the “Camera Settings” screen).
- Select desired display adjustment (Top, Middle 1, Middle 2, or Bottom).

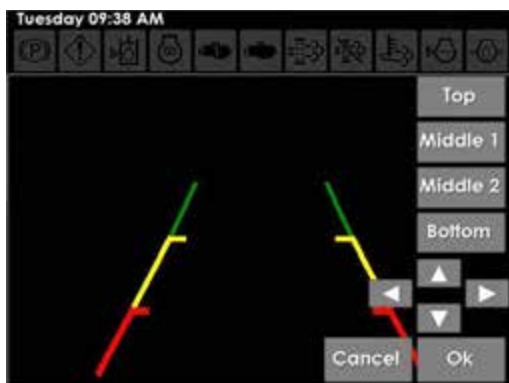

Edit Overlay Screen

- Drag display angle to desired position.
- NOTE: Press and hold the Arrow Buttons to “fine-tune” display angle.*
- Press OK.

Settings

- Press the Settings Button (located on the “Camera Settings” screen).
- On the “Camera Adjustable Settings” screen, press EDIT next to desired setting (Backup Camera in Reverse, Backup Camera Overlay, Backup Camera Projection, or Enable Camera in Road Mode).



Camera Adjustable Settings Screen

- Press YES to activate, or NO to deactivate.

Service Intervals

To Change Service Interval Settings

- Press the Service Intervals Button (located on the Settings Page).

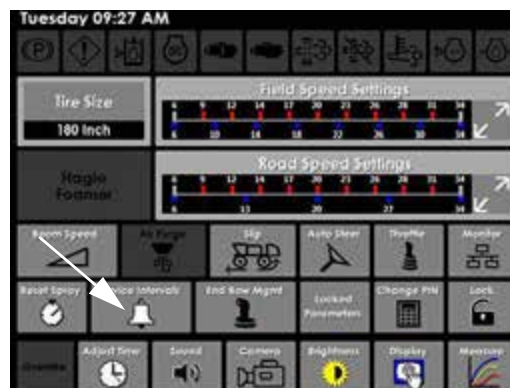

Service Intervals Button
(Located on the Settings Page)

- On the “Select Service Interval” screen, select desired service interval.



Select Service Interval Screen

- Press EDIT (next to the service interval you wish to change).
- Enter desired value.
- Press OK.
- Press RESET INTERVAL.
- Press BACK to return to the “Select Service Interval” screen. Press BACK again to return to the Settings Page.

Drive State

The Drive State of the machine is displayed on the Home Page - Road and Field Mode.

- Press the Field/Road Button (located on the Home Page) to toggle between the two Drive States. The selected Drive State will illuminate.



Field/Road Button
(Located on the Home Page - Road and Field Mode)

NOTE: The Drive State of the machine cannot be changed unless the Hydrostatic Drive Control Handle is in the NEUTRAL position (and machine speed is less than 0.5 mph/ 0.8 km/h).

The machine is featured with three (3) Drive States: ROAD, FIELD, and FAULT. The Drive State helps the machine determine what kind of work it is meant to do - field work or transport work.

Road Mode

In Road Mode, the machine is limited on what functions can be operated. Road Mode is used for transporting of the machine and therefore, will allow the machine to reach maximum speed.

NOTE: Engine speed in Road Mode can range from 850 to 2500 RPM.

Field Mode

In Field Mode, the machine is allowed function of attachments, such as Spray Booms, Snow Plow, or Flail. All-Wheel Steer (if equipped) is also only allowed in Field Mode.

NOTE: Machine speed is limited and is unable to reach maximum speed while in Field Mode.

Drive Fault

The third drive state, "Drive Fault" may appear as a warning message on the display page if there is a system malfunction that

affects the machine's ability to function properly. This message will tell you why the error occurred and what, if anything, should be done to correct the issue. As a result, machine performance will be limited.

NOTE: When a Drive Fault is present, the Field/Road Button (located on the Home Page) will be replaced by "FAULT". Settings will be in Field Mode.

Speedometer

The speed in which the machine travels is displayed on the Home Page - Road and Field Mode. The unit of measure can be viewed as miles per hour (mph) or kilometers per hour (km/h).

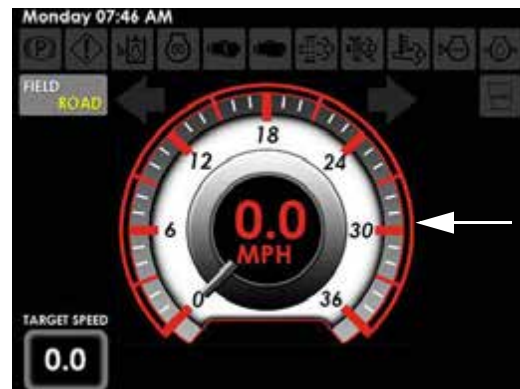

Speedometer
(Located on the Home Page - Road or Field Mode)

NOTE: See "Display Units/Animations/ Gauge Color/Language" for information on changing the unit of measure.

Target Speed

The Target Speed (displayed on the Home Page - Road and Field Mode) is the speed in which the machine travels when the Hydrostatic Drive Control Handle is in the fully FORWARD position and the Decel Pedal is NOT pressed.



Target Speed
(Located on the Home
Page - Road and Field Mode)

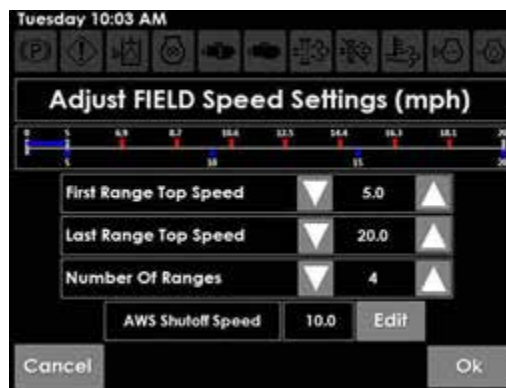

Speed Settings Screen
* *Field Speed Settings Shown*

To Change Target Speed

- Press the Adjust Button (located on the Settings Page) for desired field or road speed setting.

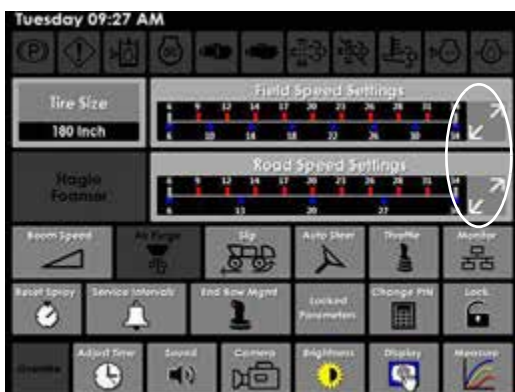

Adjust Buttons - Field/Road Speed Settings
(Located on the Settings Page)

- On the “Speed Settings” screen, evenly space target speeds as desired using the Up/Down Buttons for each setting (*First Range Top Speed, Last Range Top Speed, and Number of Ranges*).

Example:

If the “Number of Ranges Field” is set to 4, First Range Top Speed=5, and Last Range Top Speed=20, range selection would look like the following:

Range	1	2	3	4
Target Speed	5	10	15	20

- Press OK.
The machine will automatically adjust the new Target Speed according to the newly entered values.

Throttle

Throttle Control Slope

Determines how fast engine speed increases when the Throttle Switch (located near the Hydrostatic Drive Control Handle) is pressed in the UP (“rabbit icon”) position.

NOTE: Values are set as a percentage per second.

NOTE: Maximum Throttle Control Slope = 2000%/per second.

NOTE: If Throttle Control Slope is set at 25 percent/per second and Throttle Max is set at 100 percent, Throttle Up Ramp should be at least four (4) seconds to achieve 100 percent throttle when operating the Throttle Switch.

Throttle Up Ramp

Amount of time engine speed will increase or decrease when the Throttle Switch (located near the Hydrostatic Drive Control Handle) is pressed UP or DOWN.

Throttle Max

Maximum percentage that engine speed will achieve (e.g. If Throttle Max is set at 100 percent, throttle control will set engine speed between 850 and 2500 RPM. If Throttle Max is set at 0 percent, maximum engine speed will be 850 RPM).

NOTE: Pressing the Throttle Switch (located near the Hydrostatic Drive Control Handle) in the UP (“rabbit icon”) position will not increase engine speed when Throttle Max is set at 0 percent.

To Change Throttle Setting Values

- Press the Throttle Button (located on the Settings Page).

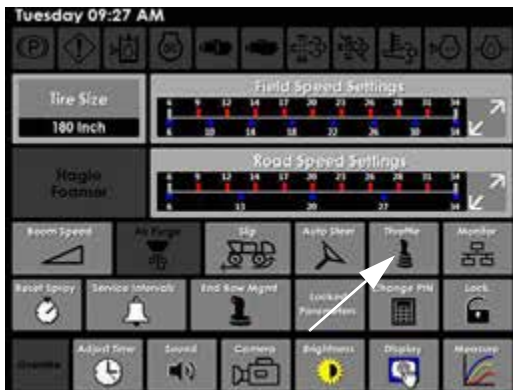

Throttle Button
 (Located on the Settings Page)

- On the “Throttle Settings” screen, press EDIT (next to the desired Throttle setting).

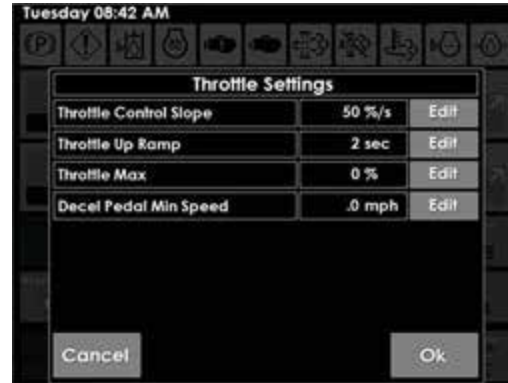

Throttle Settings Screen

- Enter desired value, then press OK.
- Press OK.

Refer to “Hydrostatic Drive” provided in the *Engine and Drive Systems Section* elsewhere in this manual for further information.

Decel Pedal Minimum Speed

The Decel Pedal (located to the lower right-hand side of steering column) is used for speed deceleration (e.g. when nearing an end row).

NOTE: The Decel Pedal is NOT a brake! It is designated for speed reduction only.

To Adjust Decel Pedal Minimum Speed

- Press the Throttle Button (located on the Settings Page).

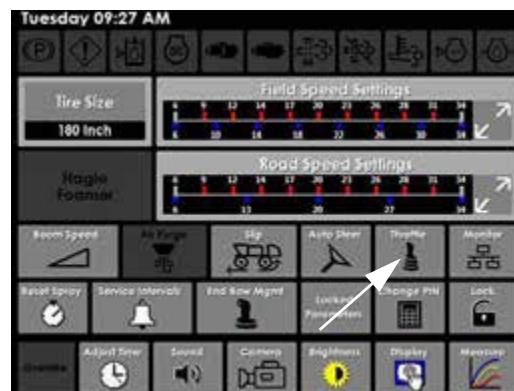

Throttle Button
 (Located on the Settings Page)

- On the “Throttle Settings” screen, press EDIT (next to Decel Pedal Min Speed).



Throttle Settings Screen

- Enter desired value, then press ACCEPT.
- Press OK.

All-Wheel Steer (AWS) ^

-If Equipped

The AWS Button is located on the Home Page - Field Mode. Enable AWS by pressing the button in the ON (illuminated) position. An AWS indicator (located below the speedometer) will illuminate when AWS is activated (requiring all conditions to be met).

- AWS Button

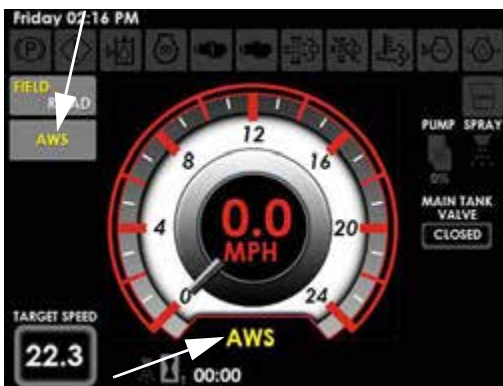

- AWS Indicator

All conditions must be met before AWS will activate. First, the machine must be in Field Mode, and second, machine speed must be less than AWS Shutoff Speed (mph-km/h). If these conditions are not met, the AWS Button will remain ON, but the AWS indicator will turn OFF, and the machine will be operating in conventional steering mode.

When conditions are met again, AWS will automatically activate and the AWS indicator will illuminate.

NOTE: The machine will automatically determine if the proper conditions have been met and change the status of the drive functions.

Shutoff Speed for AWS

NOTE: AWS Shutoff speed default is set to 10 mph (16 km/h).

- Press the Field Speed Settings Adjust Button (located on the Settings Page).

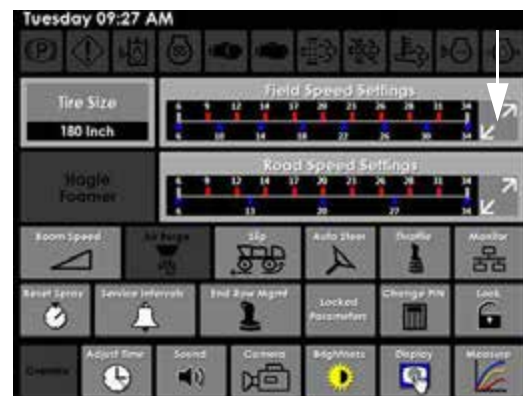

Field Speed Settings Adjust Button
(Located on the Settings Page)

- On the “Adjust Field Speed Settings” screen, press EDIT (next to AWS Shutoff Speed).

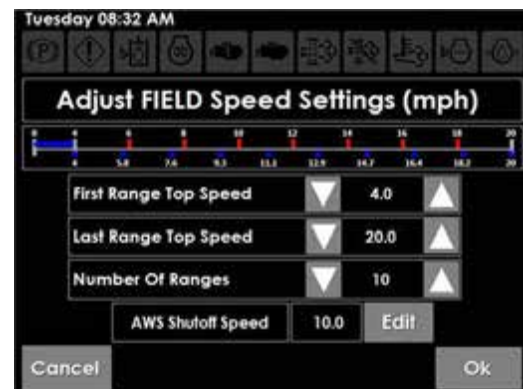

Adjust Field Speed Settings Screen

- Enter desired value.
- Press ACCEPT.
- Press OK.

Refer to “All-Wheel Steer” provided in the *Engine and Drive Systems Section* elsewhere in this manual for complete operating instructions and safety precautions.

Slip (Traction Control)

To Activate Slip

- Press the Slip Button (located on the Settings Page).

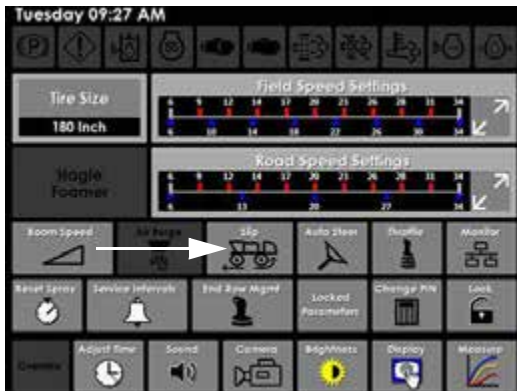

Slip Button
 (Located on the Settings Page)

- On the “Adjust Slip Parameters” screen, press NORMAL or SEVERE (depending on ground condition).



Adjust Slip Parameters Screen

- Press OK.

Custom Settings

Slip Percent

How much slip is allowed before traction control is activated.

- Press the Slip Button (located on the Settings Page).

- On the “Adjust Slip Parameters” screen, press CUSTOM.
- Press EDIT (next to Slip Percent).



- Enter desired slip percentage value, then press OK.
- Press OK.

Slip Destroke

The percentage command that the wheel motors will ramp up to limit hydraulic flow.

NOTE: The higher the destroke number, the less the hydraulic flow will go to the slipping wheel motor.

- Press the Slip Button (located on the Settings Page).
- On the “Adjust Slip Parameters” screen, press CUSTOM.
- Press the Up/Down Arrow Buttons to obtain desired destroke value.

NOTE: Slip Destroke values are available in 20-percent increments.

- Press OK.

End Row Management

The End Row Management Switch (located on the Hydrostatic Drive Control Handle) may be programmed for use of various functions, including All-Wheel Steer (if equipped) and Master Spray.

NOTE: End Row Management functions are disabled in Road Mode.

To Program the End Row Management Switch

- Press the End Row Management Button (located on the Settings Page).

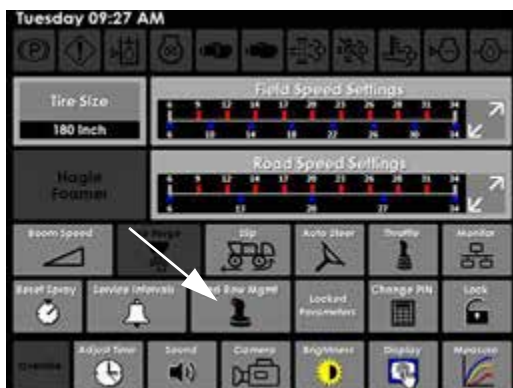

End Row Management Button
(Located on the Settings Page)

- On the “Select Action to Program” screen, select the setting in which you wish to operate the End Row Management Switch (located on the Hydrostatic Drive Control Handle) - “Single Press” or “Press and Hold”.



Select Action to Program Screen

- On the “End Row Management Editor” screen, press the “+” Button and select desired function (AWS or Master Spray).
- Press OK.

NOTE: Press the “-” Button to remove function.



End Row Management Editor Screen

- Press SET.

Delayed Time and Total Time (Milliseconds)

Delayed Time

Press the “Delayed Time” display to adjust the time from when the End Row Management Switch (located on the Hydrostatic Drive Control Handle) is pressed to when the function is engaged.

Total Time

Displays the total time from when the End Row Management Switch is pressed until delayed time starts.

Example:

	Delayed Time	Total Time	Time from when ERM Button is pressed to engagement
1.	0	0	0
2.	500	0	500
3.	1,000	500	1,500
4.	0	1,500	1,500

Edit End Row Management Settings

- On the “Select Action to Program” screen, press the Edit Settings Button.
- On the “End Row Management Settings” screen, press EDIT (next to desired End Row Management setting).
 - *Pause Before Activate*
 - *Display When Active*

- Enable Single Press
- Enable Press and Hold



End Row Management Settings Screen

- Enter desired value/setting, then press OK.
- Press OK.

Tire Size

NOTE: Refer to “Tire Specifications” provided in the Introduction Section at the beginning of this manual for further information on tire options and the corresponding rolling circumference.

To Change Tire Size Value

- Press the Tire Size Button (located on the Settings Page).

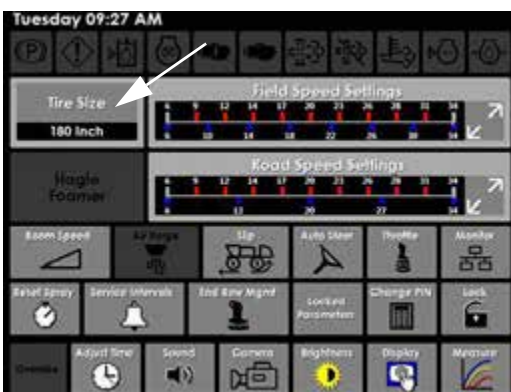

Tire Size Button
(Located on the Settings Page)

- On the “Rolling Circumference” screen, enter the tire rolling circumference.



Rolling Circumference Screen

- Press OK.

System Gauges

(Engine Load, Fuel Rate, System Voltage)

Electronic System Gauges for machine Engine Load, Fuel Rate (gallons per hour), and System Voltage are located on the Machine Diagnostics Page. Digital display indicators are located beneath each System Gauge.

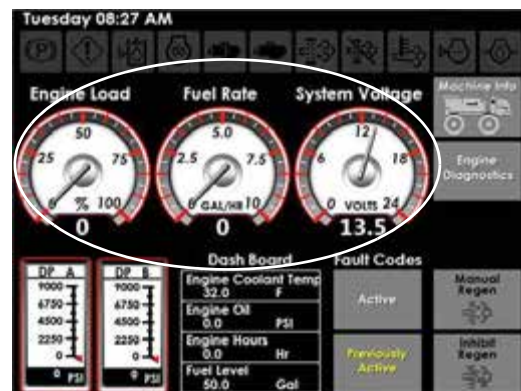

System Gauges
(Located on the Machine Diagnostics Page)

NOTE: When battery voltage depletes to 11.7 volts and below, a warning message will appear alerting you of low battery voltage.

System Diagnostics

System Diagnostics may be viewed on the Machine Diagnostics Page. Such items include:

- Engine Coolant Temperature
- Engine Oil Pressure
- Engine Hours
- Fuel Level

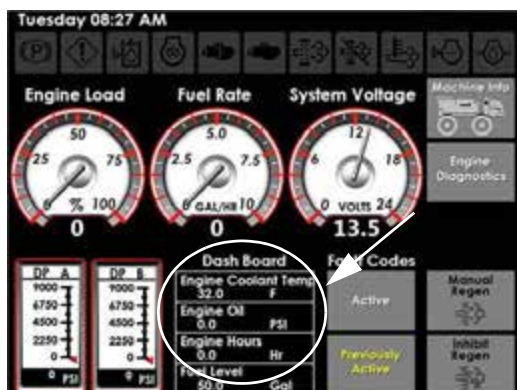

System Diagnostics
(Located on the
Machine Diagnostics Page)

When a service interval has been reached, a screen message will appear on the Machine Display informing you which service item requires attention.

Refer to the *Maintenance and Storage Section* elsewhere in this manual for information on recommended service intervals.

Engine Coolant Temperature

The Engine Coolant Temperature Gauge is located on the Machine Diagnostics Page. If the engine coolant temperature reaches a level that is too high (greater than 220° F.), a warning message will appear and a red indicator light will illuminate on the A-post temperature gauge. In addition, the warning buzzer will sound.

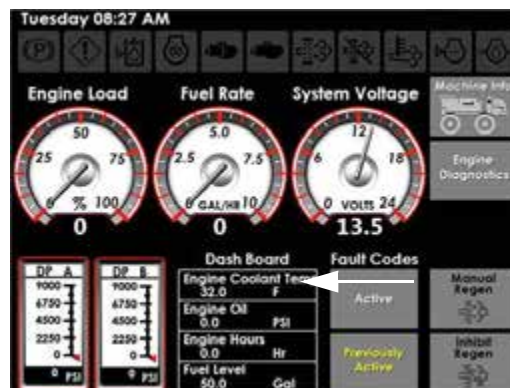

Engine Coolant Temperature Gauge
(Located on the
Machine Diagnostics Page)

NOTE: The warning buzzer may be silenced by pressing the Sound Button (located on the Settings Page).

If the engine temperature continues to rise after the initial warning message, a second warning message will appear shortly before the machine begins to go into protective mode, alerting you that the engine coolant temperature is too high and the engine will begin to de-rate. Press OK to acknowledge.

If this warning message appears, immediately reduce the engine speed and allow engine to idle. This will allow the cooling system to cool the engine down and prevent possible damage. Contact your local John Deere dealer if troubleshooting assistance is needed.

NOTE: When this warning message appears, the machine may be severely limited in engine and hydraulic functions (to prevent possible damage to those systems).

DP-A/DP-B Gauges

The DP-A and DP-B Gauges (located on the Machine Diagnostics Page) displays current drive pump pressure.

- **DP-A** (Drive Pump, Port A) - High in forward acceleration.
- **DP-B** (Drive Pump, Port B) - High in forward or reverse deceleration.

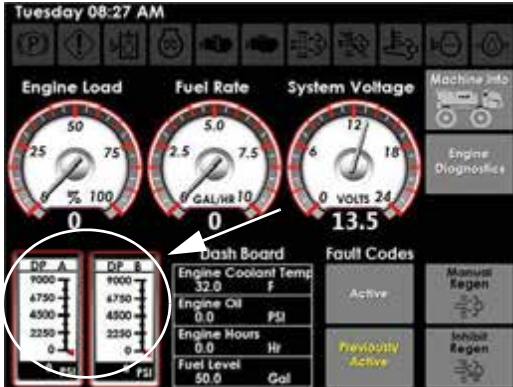

DP-A/DP-B Gauges
(Located on the
Machine Diagnostics Page)

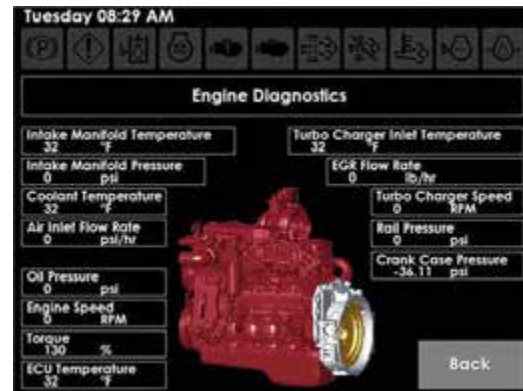

Engine Diagnostics Screen

Engine Diagnostics

To View Current Engine Diagnostics

- Press the Engine Diagnostics Button (located on the Machine Diagnostics Page).

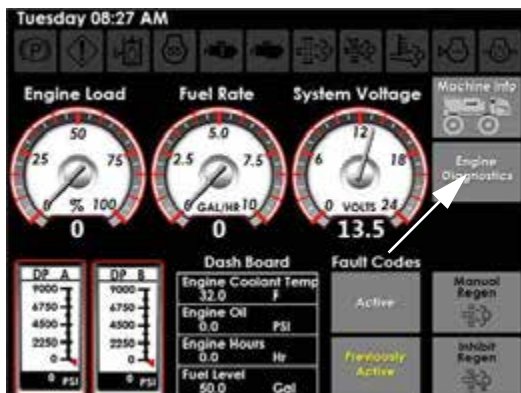

Engine Diagnostics Button
(Located on the
Machine Diagnostics Page)

Engine Shutdown Override (Tier 4 Final engines only)

NOTICE

The Engine Shutdown Override feature is not intended as means of avoiding an engine shutdown for an extended period of time.

The Override Engine Shutdown Button (located on the Machine Diagnostics Page) allows the operator to continue running the engine for a calibrated time period in order to move the vehicle to a safe stopping location.

To Temporarily Avoid Engine Shutdown

- Press and hold the Override Engine Shutdown Button (located on the Machine Diagnostics Page) momentarily.

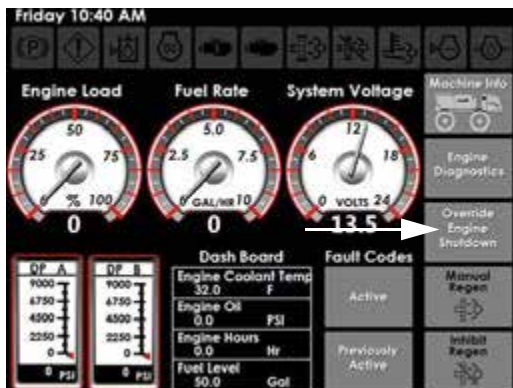

Override Engine Shutdown Button
(Located on the
Machine Diagnostics Page)

Refer to the engine manufacturer's operation manual for further information.

CAN Monitor

(Controller Area Network)

The CAN Monitor on your machine is an analysis/communication tool used in combination with machine software, which allows you to view real-time data of machine systems. The CAN Monitor screen allows you to view CAN messages on each of the CAN networks.

CAN1/CAN2/CAN3

- CAN1 = Engine
- CAN2 = Primary/Secondary Controllers
- CAN3 = Diagnostics (Primary Controller)

NOTE: CAN3 by itself does not go to display and is CAN for third party systems.

Rx (Display Message "Received")

Tx (Display Message "Transmitted")

To View CAN Status

- Press the Monitor Button (located on the Settings Page).

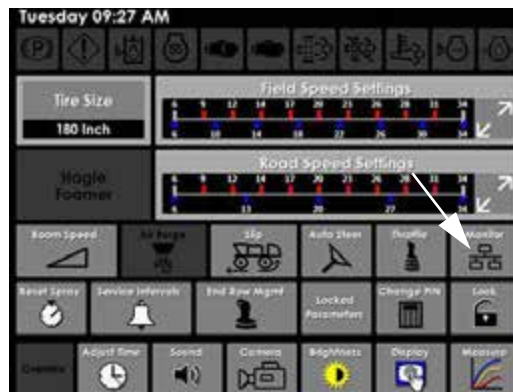

Monitor Button
(Located on the Settings Page)

- Press desired Enable CAN Button (Enable CAN1, Enable CAN2, or Enable CAN3) (located on the CAN Monitor screen) to view current CAN status.

NOTE: Press the Suppress Rx Button to remove "received" data before the Enable CAN Button is selected. Press the Suppress Tx Button to remove "transmitted" data before the Enable Can Button is selected.

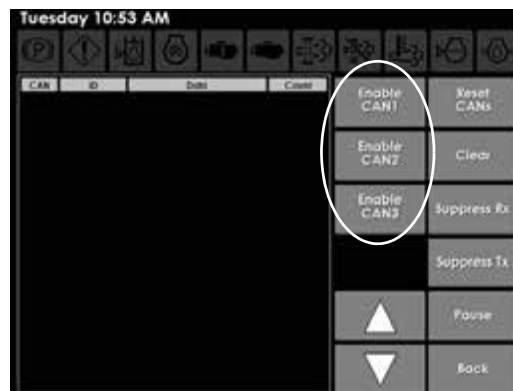

Enable CAN Buttons
(Located on the CAN Monitor Screen)

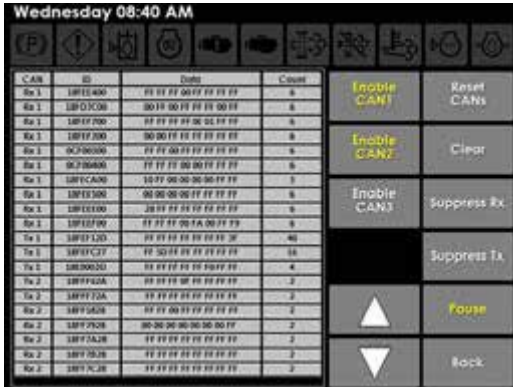

CAN Status

- Press the Pause Button at any time to pause the monitor.
- Press the Up or Down Arrow Buttons to navigate through the CAN pages individually.
- Press the Reset CANs Button to reset all CAN data.
- Press the Clear Button to clear the current screen.
- Press the Back Button to revert back to the Settings Page.

Measure

While either parked or operating the machine, current system measurements can be viewed when diagnosing or troubleshooting.

- Press the Measure Button (located on the Settings Page).

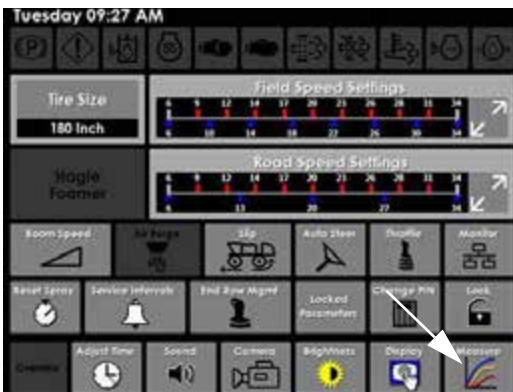

Measure Button
(Located on the Settings Page)

- Select system.
- On the “Press to Select Signals to Measure” screen, press the UP or DOWN

Arrow Buttons to toggle to desired parameters.

NOTE: Single arrow buttons toggle up/down one page. Double arrow buttons toggle to either the first or last page.



Press to Select Signals to Measure Screen

- Select desired system(s).
- NOTE: Multiple signals may be selected and viewed simultaneously.*
- Press MEASURE to view current signal measurements.



Measurement Screen

- Press BACK to revert to previous page and add or remove signals.
- Press DONE when finished.

System Faults

When a System Fault occurs, a warning message will appear on any given display page, which will inform you of the fault code and reason for the fault. Press OK to acknowledge.

Each System Fault will display the following:

1. **LAMP** (severity of fault)
 - Blue = Informational
 - Yellow = Caution
 - Red = Warning (shut down engine immediately)
2. **FAULT CODE** (refer to the fault code when speaking with your local John Deere dealer)
3. **DESCRIPTION** (fault description)
4. **OCCURENCE** (number of fault occurrences)
5. **TIME** (time fault occurred)

To View System Faults:

- Press the desired “Active” or “Previously Active” Fault Code Button (located on Machine Diagnostics Page).

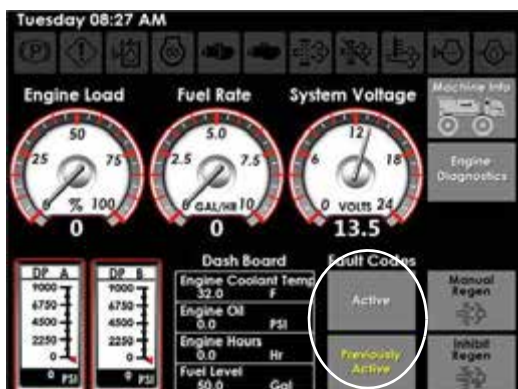

Fault Code Buttons
(Located on the
Machine Diagnostics Page)

- On the “System Faults” screen, press the Up/Down Buttons to toggle to desired fault.

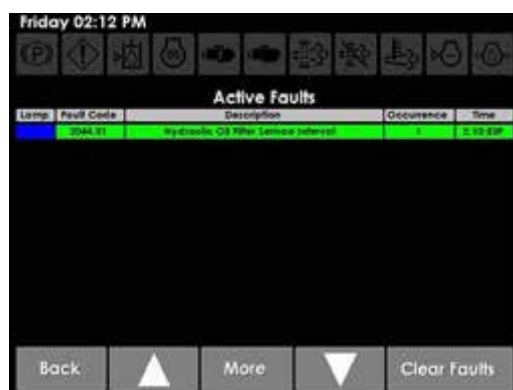

System Faults Screen

- Press the More Button to display fault description.
- Press the Clear Faults Button to remove faults after the fault issue has been resolved.
- Press OK to confirm.

NOTE: System Faults will continue to appear until the fault issue has been resolved, regardless of clearing the faults.

In the event that a severe system malfunction should occur and cause the machine to operate outside of normal operating conditions (e.g. All-Wheel Steer fault, Hydrostatic Drive Control Handle not in neutral but has no y-axis position, tire size not selected, etc.), a Machine Fault Warning message will appear on the display. This warning message will inform you that a malfunction was detected and that the machine is not responding normally and you must operate with extreme caution, as machine speed will be limited and stopping distance may be increased or decreased. Press OK to acknowledge.

In addition, a second warning message will appear informing you of the specific fault description. Contact your local John Deere dealer for assistance.

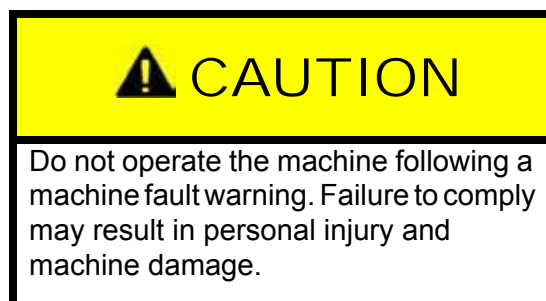
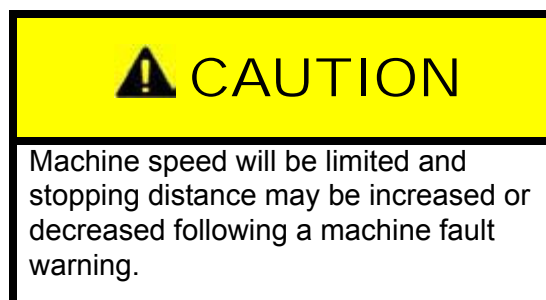

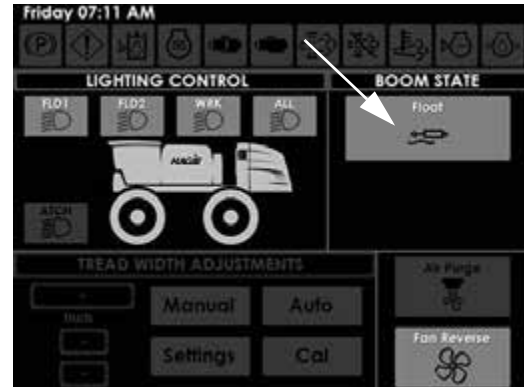

Machine Fault Warning

 Float Button
 (Located on the Auxiliary Controls Page)

Float

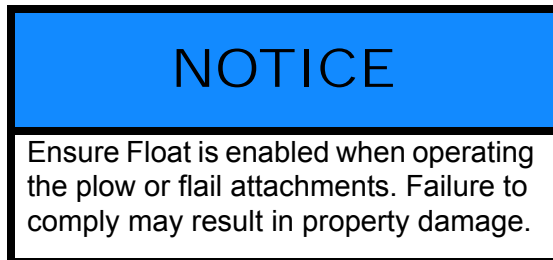

Float allows the plow and flail attachments to make minor correctional adjustments automatically while operating to avoid machine damage due to uneven ground. The Float Button (located on the Auxiliary Controls Page) is used to enable Float operation.

- Press the Float Button to enable Float. Press button again to disable Float.

NOTE: The Float Button will illuminate when in the ON position.

Broom Speed

The Broom Speed feature allows the operator to adjust the command of the broom spin valve.

To Adjust Broom Speed

- Press the Broom Speed Button (located on the Settings Page).

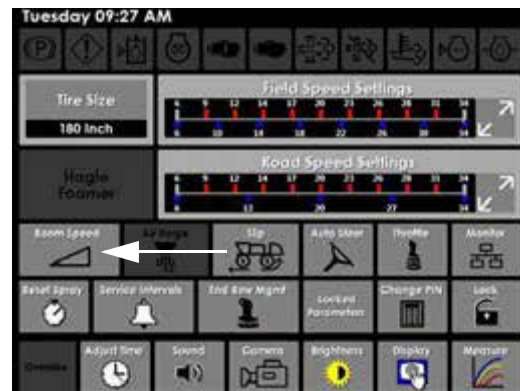
 Broom Speed Button
 (Located on the Settings Page)

- On the “Broom Speed Settings” screen, press EDIT (next to broom speed).



Broom Speed Button
(Located on the Settings Page)

- Enter desired percentage value, then press OK.

NOTE: The higher the percentage, the faster the brushes spin.

- Press OK.

Plow Door Speed

The Plow Door Speed feature allows the operator to adjust the speed in which the plow doors open and close.

To Adjust Door Speed

- Press the Broom Speed Button (located on the Settings Page).

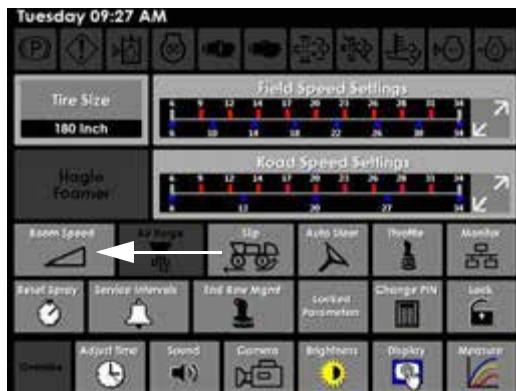

Broom Speed Button
(Located on the Settings Page)

- On the “Broom Speed Settings” screen, press EDIT (next to desired left/right plow door speed).



Broom Speed Settings Page

- Enter desired percentage value, then press OK.

NOTE: The higher the percentage, the faster the plow doors open and close.

- Press OK.

Reversible Fan

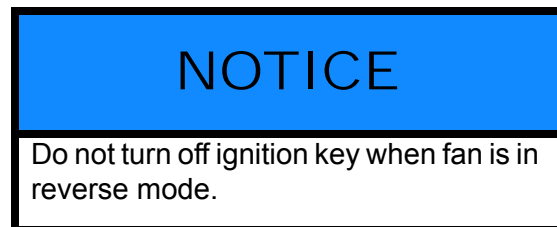

To Activate the Reversible Fan

- Press the Reversible Fan Button (located on the Auxiliary Controls Page).



Reversible Fan Button
(Located on the Auxiliary Controls Page)

- On the “Engine Fan Control” screen, press REVERSE to turn the fan ON (reverse).

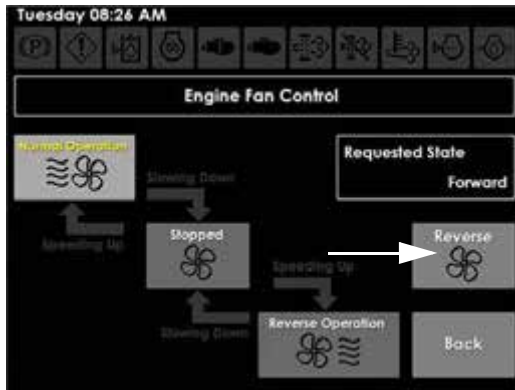

Engine Fan Control Screen

NOTE: During the reverse cycle, the “Engine Fan Control” screen will display the current state of the reversible fan (Normal Operation, Stopped, or Reverse Operation) and will let you know if the fan is slowing down or speeding up. The fan will automatically return to Normal Operation when the reverse cycle is complete.

Refer to “Reversible Fan” provided in the *Hydraulic Systems Section* elsewhere in this manual for further information.

Spray System Indicators

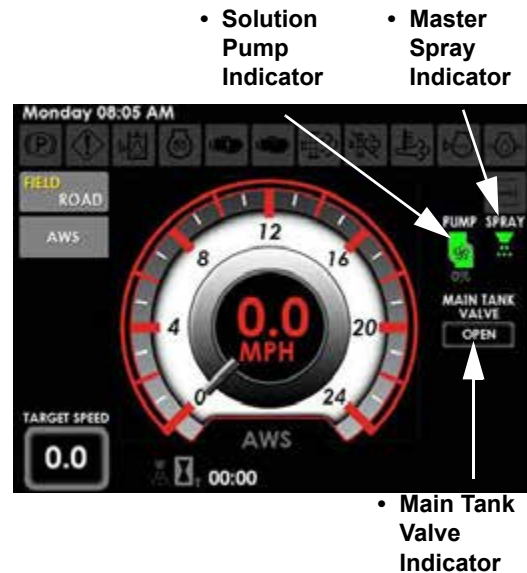

Spray System Indicators
(Located on the Home Page - Field Mode)

Solution Pump Indicator

When the Solution Pump Switch (located on the side console) is turned ON, a Solution Pump Indicator (located on the Home Page - Field Mode) will illuminate.

NOTE: When the Solution Pump Switch and the Manual (MAN) Rate Control Switch (located on the side console) are both enabled, the pump speed is displayed below the Solution Pump Indicator. Press the “+” or “-” Pump Speed/Rate Switch (located on the side console) to increase or decrease solution pump speed.

Master Spray Indicator

When the Master Spray Switch (located on the Hydrostatic Drive Control Handle) has been activated, a Master Spray Indicator (located on the Home Page - Field Mode) will illuminate.

Main Tank Valve Indicator

When the Main Tank Valve Switch (located on the side console) is activated, the Main Tank Valve Indicator (located on the

Home Page - Field Mode) will display OPEN. When the switch is not activated, the Main Tank Valve Indicator will display CLOSED.

Spray Application Time Indicator

The current amount of spray application time is displayed on the bottom of the Home Page - Field Mode.



Spray Application Time Indicator
(Located on the Home Page - Field Mode)

Reset Total Spray Time

- Press the Reset Spray Button (located on the Settings Page) to reset the total spray time.

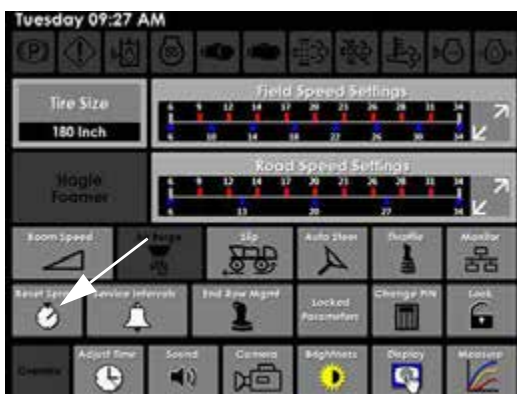

Reset Spray Button
(Located on the Settings Page)

- Press OK.

PLOW - OPERATION

The Plow attachment removes snow from airfield edge lights and signs quickly and effectively. When approaching an edge light, the plow wedge is opened by a hydraulic cylinder on the plow, and the brushes behind the wedge clear snow from around the light. Once the light is cleared off, the wedge is closed.

NOTE: The distance between the lights is plowed normally with the plow wedge closed.



The following information refers to Plow operation in conjunction with the controls inside the cab. Refer to the Plow manufacturer's operation manual for further information, which could include attachment specifications, components, safety precautions, and maintenance.

Plow Switch Functions

- (A) - Plow Raise
- (B) - Plow Lower
- (C) - Tilt Down
- (D) - Tilt Down
- (E) - Brush Open
- (F) - Brush Close
- (G) - Plow Open
- (H) - Plow Close
- (I) - Tilt Up
- (J) - Tilt Up
- (K) - Brush On/Off

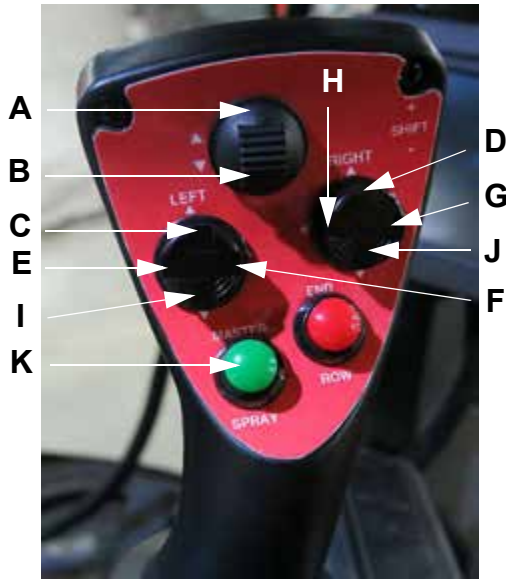

-Typical View

in the NEUTRAL position (and machine speed is less than 0.5 mph/ 0.8 km/h).

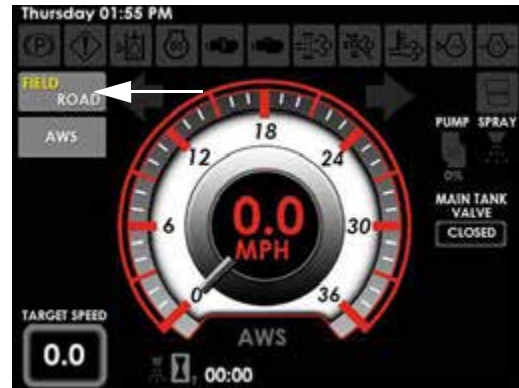

Field/Road Button
(Located on the Machine Display Home Page)

Getting Started



Clear area of personnel before operating. Failure to comply may result in serious injury or death.

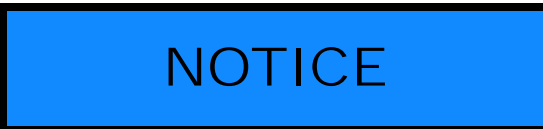

Ensure float is enabled when operating the plow attachment. Failure to comply may result in property damage.

1. Engage the parking brake.
2. Start the engine.
3. Press the Field/Road Button (located on the Machine Display Home Page) and change the machine's drive state to FIELD.

NOTE: The drive state of the machine cannot be changed unless the Hydrostatic Drive Control Handle is

- NOTE: The selected drive state will illuminate.*
4. Lower the plow to desired position.
 5. Press the Float Button (located on the Machine Display Auxiliary Controls Page) in the ON (illuminated) position to enable float.

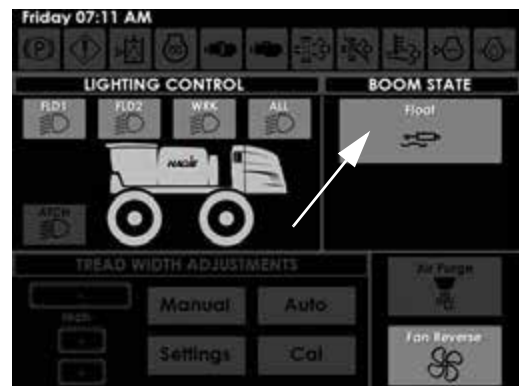

Float Button
(Located on the Machine Display Auxiliary Controls Page)

6. Press the Brush On/Off Switch (located on the Hydrostatic Drive Control Handle) in the ON position to activate the brushes and float.

NOTE: The Float Button on the display and the Brush On/Off Switch must both be depressed to activate float.



Brush On/Off Switch
(Located on the Hydrostatic
Drive Control Handle)
-Typical View



• CLOSE
• OPEN

Plow Open/Close Switch
(Located on the Hydrostatic
Drive Control Handle)
-Typical View

7. If desired, adjust broom speed.
Refer to “Machine Display” provided elsewhere in this section for further information.
8. Slowly move the Hydrostatic Drive Control Handle forward to obtain desired ground speed.
9. Upon approaching an edge light, press and hold the Plow Open Switch (located on the Hydrostatic Drive Control Handle) to open the plow wedge.

10. If desired, press and hold the Brush Open or Close Switch (located on the Hydrostatic Drive Control Handle) to adjust brush width. Release switch when desired brush width is achieved.

*NOTE: “Brush Open” increases brush width.
“Brush Close” decreases brush width.*



Brush Open/Close Switches
(Located on the Hydrostatic
Drive Control Handle)
-Typical View



11. After the edge light has been cleared, press and hold the Plow Close Switch to close the plow wedge. Repeat procedure for each edge light.
12. **When finished**, move the Hydrostatic Drive Control Handle to the NEUTRAL position.
13. Press the Brush On/Off Switch (located on the Hydrostatic Drive Control Handle) in the OFF position.
14. Press the Float Button (located on the Machine Display Auxiliary Controls Page) in the OFF position.



SECTION 4 – ENGINE AND DRIVE SYSTEMS

⚠ WARNING

**CALIFORNIA PROPOSITION
65 WARNING**

WARNING: Diesel engine exhaust and some of its constituents are known to the State of California to cause cancer and birth defects or other reproductive harm.

WARNING: Battery posts, terminals, and related accessories contain lead and lead compounds, and chemicals known to the State of California to cause cancer and birth defects or other reproductive harm.



Insufficient Cab Air Pressure Indicator
(Located on the Machine Display Home Page - Road or Field Mode)

ENGINE - STARTING

⚠ CAUTION

Start engine from the operator's seat only. When running the engine in a building, ensure there is adequate ventilation.

NOTE: An Insufficient Cab Air Pressure Indicator will appear on the Machine Display Home Page - Road or Field Mode each time the machine is started, due to a slight activation delay of the RESPA® Cab Filtration System. The indicator will disappear once the cab becomes pressurized.

Pre-Operational Checklist

1. Check engine oil level.

NOTE: Do not operate the machine when oil level is below the "L" (low) mark or above the "H" (high) mark on the engine oil dipstick.

2. Check coolant level.
3. Check diesel exhaust fluid level (Tier 4 Final engines only).
4. Check hydraulic reservoir oil level.
5. Check cooling air intake screen.
6. Drain fuel/water separator.
7. Check engine drive belt.
8. Drain water out of the air tank.
9. Check for any oil or fuel leaks.

Cold Start Procedure

1. Engage the parking brake.

NOTE: Refer to "Hydrostatic Drive" provided elsewhere in this section for further information.

2. Turn the Ignition ON, but DO NOT engage the starter. **(Wait for the Grid Heater ON indicator to disappear on the Machine Display).**

The following warning message will appear on the Machine Display during cold weather conditions. Press OK (acknowledging that you understand the engine requires a warm-

up period before engaging the starter).



NOTE: Ensure that there are no other warnings before proceeding.

- Engage the starter.
(If the engine fails to start after 15 seconds, turn the key OFF, wait one minute, and repeat the procedure. If the engine does not start after three attempts, check the fuel supply system).

NOTE: Absence of blue or white exhaust smoke while cranking indicates that no fuel is being delivered.

- Observe warning lights on the Machine Display (after start-up).
NOTE: If any functions do not operate, shut the engine OFF and determine cause.
- Allow a warm-up period of at least five (5) minutes before operating the engine at a high RPM.

NOTE: The engine must reach operating temperature and oil pressure must stabilize in the normal operating range before it is run faster than idle speed (1,000 RPM or less).

- Disengage the parking brake.

Jump Starting

- Engage the parking brake.
- Rotate the Battery Disconnect Switch (located on the rear mainframe) to the ON position.



Battery Disconnect Switch
(Located on the rear mainframe)
-Typical View

- Remove caps from the Auxiliary Battery Charging Posts (located on the rear mainframe).

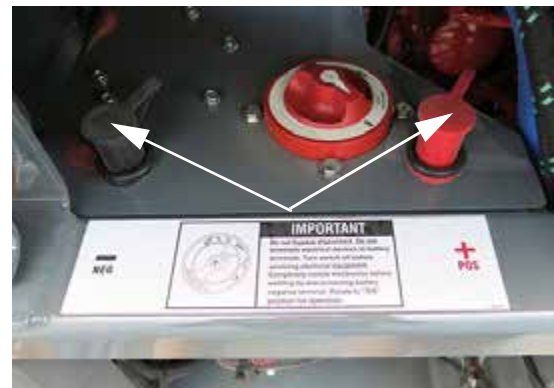

Auxiliary Battery Charging Posts
(Located on the rear mainframe)
-Typical View

- Connect cables from charging device (i.e. battery charger or another machine) to the Auxiliary Battery Charging Posts - positive cable to the positive terminal, and negative cable to the negative terminal.
- Allow batteries to charge approximately 5-10 minutes.

NOTICE

Do not over- crank the starter. Failure to comply may result in starter damage.

6. Engage the starter by starting the machine.
7. Remove the charging cables in reverse to the way you attached them (negative cable first, then positive cable).

NOTE: Ensure that the charging cables do not touch together or to any metal surface.

8. Reinstall the Auxiliary Battery Charging Post caps.
9. Allow engine to idle for approximately 5 minutes to recharge the batteries.

NOTE: Longer idle time may be required, depending on how depleted the batteries are.

ENGINE AFTERTREATMENT - TIER 4 FINAL

 **WARNING**

It is unlawful to tamper with or remove any component of the Aftertreatment System. It is also unlawful to use Diesel Exhaust Fluid (DEF) that does not meet the specifications provided or to operate the machine with no DEF.

 **WARNING**

DEF contains urea. Do not get the substance in your eyes. In case of contact, immediately flush eyes with large amounts of water for a minimum of 15 minutes. Do not swallow internally. In the event the DEF is ingested, contact a physician immediately.

 **WARNING**

Read the DEF manufacturer's label and comply with safety precautions to avoid injury or damage.

 **CAUTION**

Never attempt to create DEF by mixing agricultural grade urea with water. Agricultural grade urea does not meet the necessary specifications required and the Aftertreatment System may be damaged.

 **CAUTION**

Aftertreatment DOC and DRT components may be hot. Allow engine to cool before handling. Failure to comply may result in injury.

 **CAUTION**

Never add water or any other fluid besides what is specified to the DEF tank. Failure to comply may result in Aftertreatment System damage.

 **CAUTION**

Do NOT add any chemicals/additives to the DEF in an effort to prevent freezing. If chemicals/additives are added to the DEF, the Aftertreatment System may become damaged.

⚠ CAUTION

When performing a stationary exhaust system cleaning, ensure the exhaust pipe outlet is not directed at any surface or material that may become hazardous.

NOTICE**USE CORRECT FLUID TYPES**

- Use only low-ash diesel engine oil.
- Use only ultra-low sulfur diesel (ULSD) fuel.
- Use only DEF meeting ISO 2224101 standards.

Failure to use the required fluid types will result in engine damage and will void the warranty.

NOTICE

Never operate the engine with low DEF level.

NOTICE

Do not direct water into exhaust opening. Failure to comply may result in system damage and will void the warranty.

NOTICE**DEF CAN BE CORROSIVE TO CERTAIN MATERIALS**

- Use only approved containers to transport or store DEF (polyethylene and polypropylene containers recommended).
- If DEF is spilled, rinse and clean immediately with water.
- Avoid contact with skin. If contact occurs, wash off immediately with soap and water.

NOTICE

Wipe up spills immediately with clean water. If DEF is left to dry, a white residue will remain. Failure to clean spilled DEF appropriately may result in an incorrectly diagnosed leak of the DEF Dosing System.

NOTICE

Thoroughly wash any containers, funnels, etc. that will be used to dispense, handle, or store DEF. **Rinse with distilled water only.** Use of tap water to rinse components will contaminate the DEF.

NOTICE

If incorrect fluid is mistakenly added to the DEF tank (e.g. water, diesel fuel, hydraulic oil, engine coolant, windshield washer fluid, etc.), contact the engine manufacturer to determine the appropriate repair.

The Tier 4 Final diesel engine is featured with a flow-through exhaust Aftertreatment System that delivers ultra-low emissions for cleaner air quality.

NOTE: When the ignition key is turned to the OFF position, DEF returns to the DEF tank.

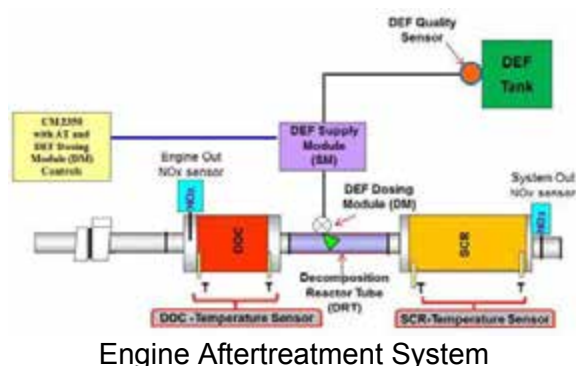

Aftertreatment System Components

- Tier 4 Final Diesel Engine
- Diesel Exhaust Fluid (DEF) Tank
- Diesel Exhaust Fluid (DEF) Gauge
- Diesel Oxidation Catalyst (DOC)
- Decomposition Reactor Tube (DRT)
- Selective Catalytic Reduction (SCR)
- DEF Dosing Module
- DEF Supply Module
- DEF Supply Module Filter
- DEF Quality Sensor
- DEF Suction Strainer

Tier 4 Final Diesel Engine



Tier 4 Final Diesel Engine
(Located near rear of machine
- open hood to access)
-Typical View

DEF Tank

- DEF Tank Capacity = 10 Gallons (37 L)

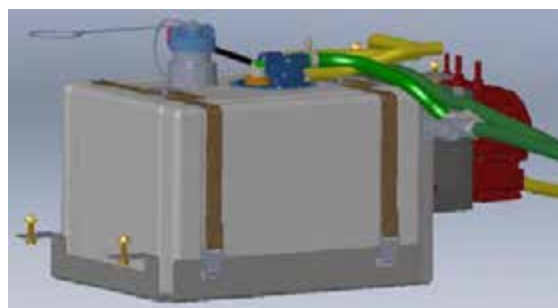

DEF Tank
(Located beneath center of machine)
-Typical View

DEF (Diesel Exhaust Fluid)

DEF is used in Selective Catalyst Reduction (SCR) Systems to help convert nitrogen oxide (NOx) emissions in engine diesel exhaust into harmless nitrogen and water vapor.

NOTE: Check DEF level daily.

Fluid Type:

- Use only DEF which meet ISO 2224101 standards.

Fluid Storage:

- Store DEF between 23° F (-5° C) and 77° F (25° C).

- Refer to “Service - Fluids” provided in the *Maintenance and Storage Section* elsewhere in this manual for additional information.

Fluid Disposal:

- Check with local authority regulations on proper DEF disposal requirements.

DEF Gauge

The DEF Gauge (located on the cab A-post) allows the operator to view current DEF tank level at all times.



DEF Gauge
(Located on cab A-post)
-Typical View

DOC (Diesel Oxidation Catalyst)

The DOC reduces carbon monoxide and hydrocarbons produced by the engine.

DRT (Decomposition Reactor Tube)

The DRT is a mixer tube where DEF is injected and mixes with exhaust from the diesel engine, which is then converted into ammonia.

SCR (Selective Catalytic Reduction)

The SCR is where the DEF reduces gaseous nitrogen oxide (NOx) to near zero levels by converting into nitrogen gas and water vapor.

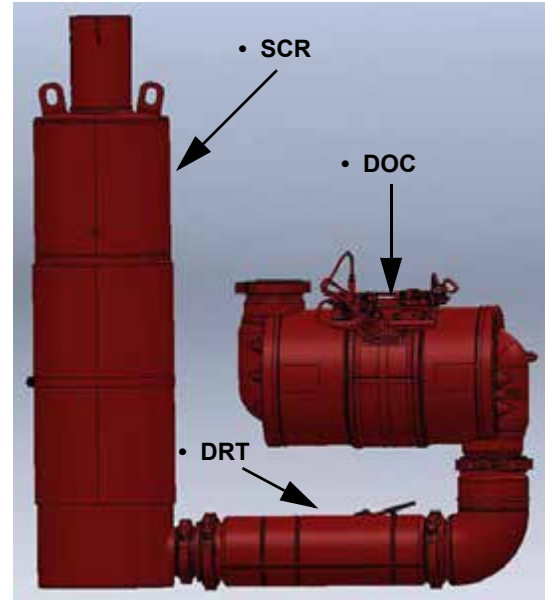

-Typical View

DEF Dosing Module

The DEF Dosing Module allows a fine mist of DEF to be sprayed into the hot exhaust.

DEF Supply Module

The DEF Supply Module pumps DEF from the tank to the Dosing Injector (located in the DRT).

DEF Supply Module Filter

The DEF Supply Module Filter (located near the bottom of the DEF Supply Module) filters DEF before going to the Dosing Injector. Change filter every 4,500 hours of operation or every 3 years, whichever occurs first.

NOTE: Refer to the engine manufacturer's operation manual for further information.

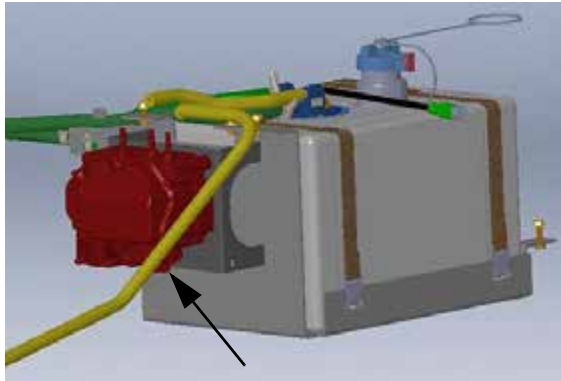

DEF Supply Module Filter
(Located near the bottom
of the DEF Supply Module)
-Typical View

DEF Quality Sensor

The DEF Quality Sensor (located inside the tank) detects DEF tank level, as well as quality and temperature of the DEF, which are required for the Aftertreatment System to function properly.

DEF Suction Strainer

The DEF Tank is equipped with a Suction Strainer (located near bottom of tank). If degraded system performance occurs, remove drain plug (located at bottom of tank) to drain sediment from tank. Remove and clean Suction Strainer, ensuring the strainer is reinstalled correctly when finished.

NOTE: Flush DEF Tank and components with distilled water only to remove any contamination. Refer to the engine manufacturer's operation manual for further information.

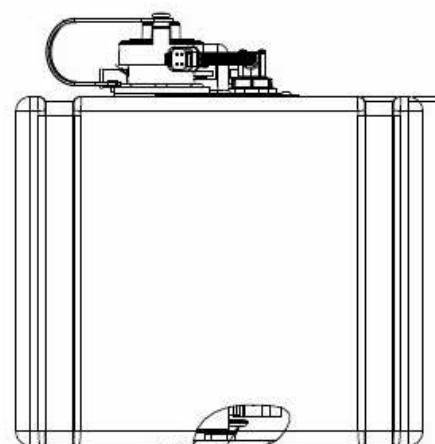

- DEF Suction Strainer
- DEF Tank Drain Plug

DEF Suction Strainer and Drain Plug
(Located near bottom of the DEF Tank)
-Typical View

Filling the DEF Tank

DEF Indicator Lamps

(Located on the Machine Display)



- **DEF Indicator Lamp** - Illuminates when the DEF level is low, and flashes when the DEF falls below a very low level. Operator should refill the DEF tank with DEF.



- **Flashing DEF Indicator Lamp with Check Engine Indicator Lamp** - Illuminates when the DEF level is critically low. If the tank is not refilled immediately, power will be reduced. Operator should refill the DEF tank with DEF. Normal engine power will be restored after the DEF tank is refilled.



- **Flashing DEF Indicator Lamp with Stop Engine Indicator Lamp** - Illuminates when the DEF gauge reads zero. Power will be reduced or limited to idle. Operator should stop the machine when it is safe to do so and refill the DEF tank. Normal engine power will be restored once the DEF tank is refilled.



1. Shut the engine OFF.
2. Lift the DEF Fill Access Panel (located near center platform behind solution tank).
3. Remove DEF Fill Cap and set aside.

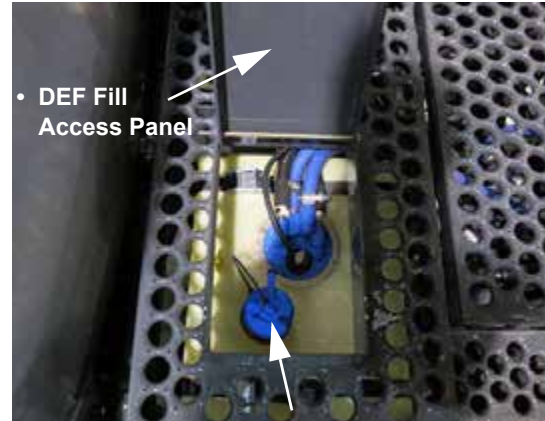

DEF Fill Cap

(Located beneath center platform behind solution tank - lift panel to access)

-Typical View

4. Fill tank with DEF.
5. Reinstall DEF Fill Cap.

NOTE: Refill tank with DEF every other fuel fill.

6. Close DEF Fill Access Panel.

Stationary Exhaust System Cleaning

Your Tier 4 Final diesel engine requires little or no operator interaction. Under certain circumstances, an operator-initiated Exhaust System Cleaning may be required. Exhaust System Cleaning Indicator Lamps (located on the Machine Display) will illuminate to show system status.

Exhaust System Cleaning Indicator Lamps

(Located on the Machine Display)



ON

- **High Exhaust System Temperature (HEST) Indicator Lamp** - May illuminate due to higher than normal exhaust temperature during Exhaust System Cleaning. Operator should ensure that the exhaust pipe outlet is not directed at any flammable or combustible surfaces.



ON

- **Exhaust System Cleaning Indicator Lamp** - Illuminates when the exhaust system is unable to complete an automatic Exhaust System Cleaning event. Operator should ensure that the Exhaust System Cleaning Switch is not in the STOP position and continue working until there is an opportunity, such as at the end of the work day or shift to complete a stationary Exhaust System Cleaning.



ON

- **Exhaust System Cleaning Indicator Lamp with Check Engine Indicator Lamp** - If an Exhaust System Cleaning is not performed in a timely manner after the Exhaust System Cleaning Indicator Lamp is illuminated, the Check Engine Indicator Lamp will illuminate and engine power will be significantly reduced. Park the machine when safe to do so and press the Exhaust System Cleaning Start Switch. Once cleaning is complete, full engine power will be restored.



FLASHING

- **Exhaust System Cleaning Indicator Lamp** - Flashes when a stationary Exhaust System Cleaning event is initiated using the Exhaust System Cleaning Start Switch. This lamp will continue to flash until the stationary cleaning event is complete. Once the lamp turns off, the operator can resume normal operation.

Exhaust System Cleaning Indicator Lamps (Continued)



ON

- **Exhaust System Cleaning Stop Indicator Lamp** - Illuminates when the Exhaust System Cleaning Switch is in the STOP position, preventing a cleaning event. This switch should be used only when high exhaust temperatures present a hazard. Excessive use of the Exhaust System Cleaning Switch in the STOP position will result in the need for more frequent stationary exhaust cleaning events.



ON

- **Stop Engine Indicator Lamp (if equipped)** - Illuminates when continued operation could result in damage to the exhaust system. Shut down the engine as soon as it is safe to do so and call for service to avoid damage to the exhaust system.

To Perform an Exhaust System Cleaning

1. Park the machine in a safe location where the exhaust pipe outlet will not face any combustible surface.
2. Engage the parking brake.
3. With the engine running and at idle, press the Manual Regen Button (located on the Machine Display - Machine Diagnostics Page).

NOTE: When the cleaning event is activated, engine speed may increase and the HEST Indicator Lamp (located on the Machine Display) may illuminate and the Exhaust System Cleaning Indicator Lamp will flash.

4. Monitor the machine and surrounding area for safety.

NOTE: If the machine needs to be used or moved, stop the stationary cleaning event by increasing the Throttle Switch (located near the Hydrostatic Drive Control Handle).

5. When the Exhaust System Cleaning is complete, the engine will return to normal idle speed and the HEST and

Exhaust System Cleaning Indicator Lamps will turn off.

Further Information

Refer to the *Maintenance and Storage Section* provided elsewhere in this manual for additional Aftertreatment service and maintenance information.

Refer to the engine manufacturer's operation manual for complete operating instructions and safety precautions.

HYDROSTATIC DRIVE

The Hydrostatic Drive System uses pressurized hydraulic fluid to drive the machine. The Hydrostatic Drive System consists of four components: Diesel Engine, Hydrostatic Pump, Wheel Motors, and Wheel Hubs.

Hydrostatic Drive Components

- Cummins® Diesel Engine
- Hydrostatic Pump
- Wheel Motors (4)
- Wheel Hubs (4)

Engine and Hydrostatic Pump

Your machine is featured with a Cummins diesel engine (located beneath the rear hood). The engine has a direct-mounted Hydrostatic Pump (located near center of machine).



Tier 4 Final Diesel Engine
-Typical View

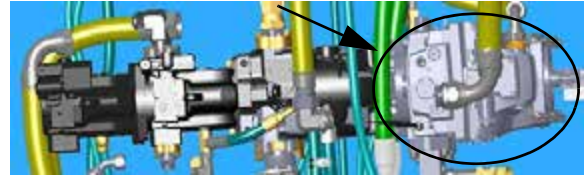

Hydrostatic Pump (Drive Pump)
-Typical View
(Viewed from top of machine)

Wheel Motors and Hubs

The drive system consists of hydraulic Wheel Motors and Gear Reduction Hubs (Wheel Hubs) located on each wheel.



Wheel Motor
-Typical View

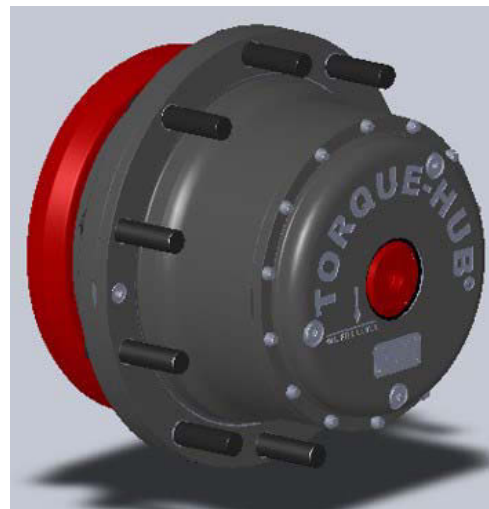

Wheel Hub
-Typical View

Parking Brake

The Parking Brake will engage when applied hydraulic pressure falls below 150 PSI (10.3 bar) or if the engine is shut off.

CAUTION

Do not engage the parking brake while the machine is moving. Failure to comply may result in personal injury and machine damage.

NOTICE

The parking brake is not intended for normal or emergency stopping.

NOTE: Bring the machine to a complete stop before engaging the Parking Brake.

The Parking Brake also controls the Ladder. When the Parking Brake is engaged, the Ladder will extend (lower). When the Parking Brake is disengaged, the Ladder will retract (raise).

CAUTION

Ensure the Hydrostatic Drive Control Handle is in the NEUTRAL position before engaging the parking brake. Failure to comply may result in personal injury and/or machine damage.

- **To engage the Parking Brake and lower the Ladder**, move the Hydrostatic Drive Control Handle to the NEUTRAL position.

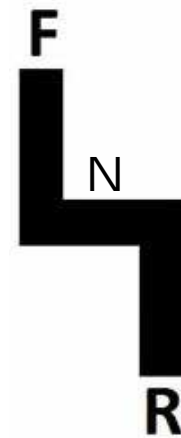

Hydrostatic Drive Control Handle
-Typical View

- Slide the red safety lever (located on the Parking Brake Switch) DOWN (Back) and press top of switch DOWN.



Parking Brake Switch
(Located near the Hydrostatic Drive Control Handle)
-Typical View

NOTE: When the Parking Brake is engaged, a parking brake indicator (located on the top left-hand side of each Machine Display page) and the Parking Brake Switch will illuminate.



Parking Brake Indicator
(Located on the top left-hand
side of each Machine Display page)

To Disengage the Parking Brake

NOTICE

The Decel Pedal must be held in the DOWN position while disengaging the parking brake.

NOTE: If the Hydrostatic Drive Control Handle is out of neutral while the parking brake is engaged, the following warning message will appear on the Machine Display. Press OK to acknowledge and move control handle to the NEUTRAL position before proceeding.



Parking Brake Warning Message

- **To disengage the Parking Brake and raise the Ladder**, press and hold the Decel Pedal (located to the lower right-

hand side of the steering column) and press the Parking Brake Switch in the DOWN (Off) position.

Deceleration (Decel) Pedal

When nearing an end row and speed deceleration is desired, press the Decel Pedal (located on the lower right-hand side of the steering column) to decrease speed.

NOTE: The Decel Pedal is NOT a brake! It is designated for speed reduction only.



Decel Pedal
(Located on the lower right-hand
side of the steering column)
-Typical View

Setting Decel Pedal Minimum Speed

Refer to “Machine Display” provided in the Cab Section elsewhere in this manual for further information.

Target Speed

The Target Speed (displayed on the Machine Display Home Page - Road and Field Mode) is the speed in which the machine travels when the Hydrostatic Drive Control Handle is in the fully FORWARD position and the Decel Pedal is NOT pressed.

NOTE: The Target Speed displayed is the maximum speed for the selected speed range.



Target Speed
(Located on the Home
Page - Road and Field Mode)

To Change Target Speed

Refer to “Machine Display” provided in the *Cab Section* elsewhere in this manual for further information.

Throttle Switch

The Throttle Switch (located near the Hydrostatic Drive Control Handle) is used to control engine speed (RPM).

NOTE: The operator may select throttle setting by operating the Throttle Switch. However, engine speed is also controlled by movement of the Hydrostatic Drive Control Handle.



Throttle Switch
(Located near the Hydrostatic
Drive Control Handle)
-Typical View

NOTE: Engine speed can range between 850 and 2500 RPM in both Road and Field Mode.

The Throttle Switch works with a timer to tell the engine how fast to run. The longer the operator holds the switch in either direction (press UP/“rabbit icon” to increase the speed, press DOWN/“turtle icon” to decrease the speed), the more the engine will speed up or slow down.

To Change Throttle Setting Values

Refer to “Machine Display” provided in the *Cab Section* elsewhere in this manual for information.

Speed Ranges

Speed ranges are selected by pressing the Shift Up/Down Switches (located on the Hydrostatic Drive Control Handle). Refer to “Machine Display” provided in the *Cab Section* elsewhere in this manual for further information on adjusting speed range settings.

Example:

If speed ranges are set at 5, 10, 15, and 20 mph (8, 16, 24, and 32 km/h), the machine will start in the 5 mph (8 km/h) target range. Press the Shift Up Switch once to reach 10 mph (16 km/h). Continue to press switch to reach 15 and 20 mph (24 and 32 km/h), as desired. Press the Shift Down Switch gradually to decrease speed range.

NOTE: The Shift Up/Down Switches can also be held to increase or decrease speed ranges.



Shift Up/Down Switches
(Located on the side of the
Hydrostatic Drive Control Handle)
-Typical View

- **To move the machine forward**, slowly push the Hydrostatic Drive Control Handle FORWARD.

NOTE: The further the handle is moved forward, the faster the machine will travel and the engine speed will increase.

- **To move the machine in reverse**, slowly pull the Hydrostatic Drive Control Handle backward.

NOTE: Machine speed is limited to 9 mph (14.5 km/h) when in reverse.

NOTE: The farther back the handle is pulled, the faster the machine's speed.

- **To stop the machine**, slowly place the Hydrostatic Drive Control Handle in the NEUTRAL position.

NOTE: Before turning the engine off, reduce the engine speed and allow to idle for a minimum of three (3) minutes.

Drive System Control

WARNING
<p>Ensure the back-up alarm is audible when operating the machine in reverse.</p>

NOTE: The NEUTRAL position must be met before changing the direction of the machine.

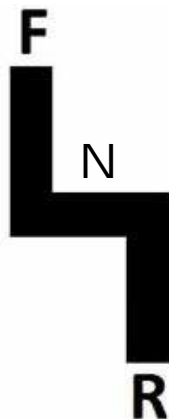

<h2>NOTICE</h2>
<p>The operator can choose a minimum level above 850 RPMs of engine speed that they want to operate the machine with by using the Throttle Switch.</p>

ALL-WHEEL STEER (AWS)

-If Equipped

^ Operator's with machines equipped with AWS pay special attention!

<h2>NOTICE</h2>
<p>Become familiar with the machine in both coordinated and conventional steering modes before attempting to use the machine for its intended use. ^</p>

NOTE: Read the following AWS information thoroughly and understand the operating instructions and safety precautions before operating.



Hagie Manufacturing Company recommends becoming familiar with and understanding how to operate your machine in conventional steering mode before operating AWS. Understand AWS system components, operating procedures, and system limitations before operating.

The term “coordinated steering” is used to describe the AWS feature. Coordinated steering is when the front wheels turn one direction and the rear wheels turn in the opposite direction to create a tighter turn angle, which allow the rear wheels to follow the front wheel tracks. Operating your machine in AWS mode makes turning more efficient by minimizing crop damage and ground disturbance.

Ensure you are comfortable driving the machine on the road and in the field, with the booms in the transport and spray positions, as well as performing a variety of different turning scenarios before attempting to operate AWS.

Progressive AWS

Hagie Manufacturing Company’s Progressive AWS takes the original design and increases the active speed range while maintaining a safe turning radius. This is done by limiting how far the rear wheels will turn at higher speeds. The improvement allows operators to follow contours in the field and leave only one set of wheel tracks. This also allows them to make wide turns on end rows with only one set of wheel tracks.

Your rear wheels will track the front wheels, with limitations on speed and turning percentage. This is completely variable, so if you accelerate in a turn, your match on the rear will slowly come out. This feature keeps the machine safe when turning.

NOTE: If you want to match all the time, decrease your speed or make a less drastic turn.

NOTE: AWS is disabled when Auto Steer is active.

Terminology

Conventional Steering

- Only the front wheels turn.

Coordinated Steering ^

- All the wheels turn and do so where the rear tires follow in the front tires’ tracks.

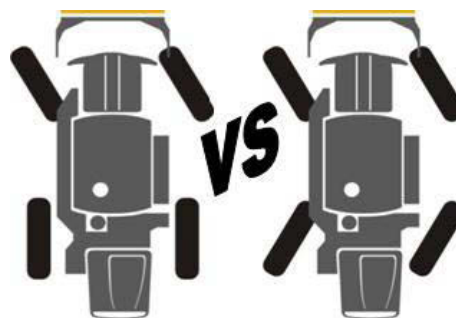

AWS Components

The Steering Cylinder (internal position) and External Proximity Sensors are used to track cylinder rod extension.

Steering Cylinders



Steering Cylinder
-Typical View

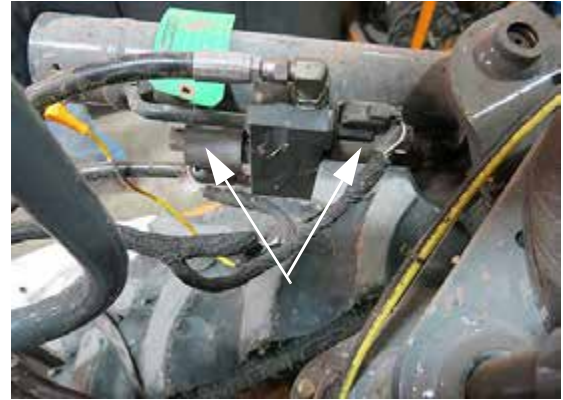

Lock Valves
-Typical View

Valve Manifold

Rear hydraulic steering is controlled by a Valve Manifold (located on the underside of the machine).



Valve Manifold
(Located on the underside of machine)
-Typical View

External Proximity Sensors



External Proximity Sensor
-Typical View

Lock Valves

Each rear cylinder is equipped with two (2) Lock Valves, which lock the cylinders into position when in Road mode and when the machine is not moving in Field mode.

Operating AWS

All conditions must be met before AWS will activate. First, the machine must be in Field mode, and second, machine speed must be less than AWS Shutoff Speed. If these conditions are not met, the AWS Button will remain ON, but the AWS indicator will turn OFF, and the machine will be operating in conventional steering mode.

When conditions are met again, AWS will automatically activate and the AWS indicator will illuminate.

NOTE: The machine will automatically determine if the proper conditions have been met and change the status of the drive functions.

1. Ensure the machine's drive state is in Field mode.
2. Press the AWS Button (located on the Machine Display Home Page - Field Mode) to the ON (illuminated) position.

• **AWS Button**

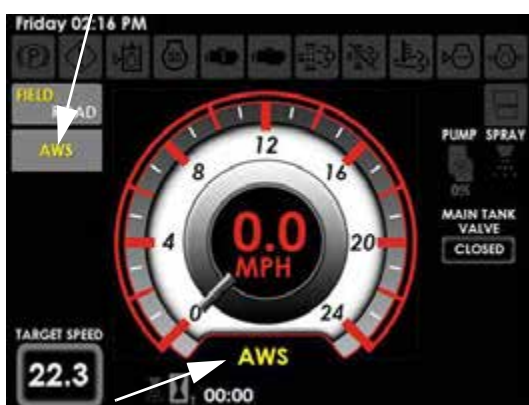

• **AWS Indicator**

An AWS indicator (located below the speedometer) will illuminate when AWS is activated (requiring all conditions to be met).

Shut off Speed for AWS

Refer to “Machine Display” provided in the *Cab Section* elsewhere in this manual for further information.

Limitations

- Machine speed is greater than AWS Shut-off Speed.

NOTE: There is no warning message associated with this. The machine will automatically switch to conventional steering mode.

- The machine's drive state must be in Field mode. If the machine is in Road mode, AWS is disabled (and the rear cylinder Lock Valves are locked).

- System Fault - The system is not working properly (e.g. sensor malfunction, hydraulic malfunction, etc.)

NOTE: A warning message will appear on the Machine Display and the machine may be limited on speed and other functions.

- **Auto Steer Machines Only:**
When the Auto Steer System is engaged, it will automatically turn the AWS System OFF and move the rear wheels back to straight.

Recommendations for Best Operating Practices

- Apply the Decel Pedal (located to the lower right-hand side of the steering column) to decrease speed at end rows.

NOTE: The Decel Pedal is NOT a brake! It is designated for speed reduction only.

- Speed ranges are selected by pressing the Shift Up/Down Switches (located on the Hydrostatic Drive Control Handle) to control speed ranges within the vehicle speed settings.
- Use the Hydrostatic Drive Control Handle to slow down more if needed. If you move the Hydrostatic Drive Control Handle first and then shift down to get to AWS mode, you will notice that the machine may slow down more than you wanted it to.
- Understand how the machine feels when it is still in a turn and is shifted up or down. The machine will still operate at whatever turn angle that you want to shift out at, but you may feel that this situation is causing an operation that you may not want (possibly getting the machine off the line intended because the rear wheels move back to straight position and the total turning radius will change).

In the following illustration, the two circles represent a full turn with AWS on. The - - - lines represent the direction the operator wants the front tracks to go (assuming the operator wants to pull the machine back into

rows that are running straight up and down.) The -.-.-.- lines represent the direction that the front wheels are pointed when the operator shifts out of AWS speed range. If this occurs, the rear wheels will shift back to the straight position and the machine will no longer have the two tire tracks (two circles). The rear wheels will begin to follow the -.-.-.- path during this shift.

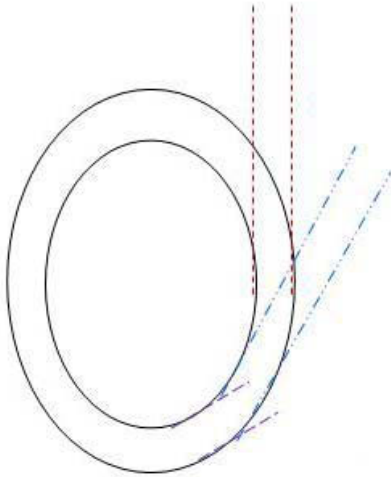

Hagie Manufacturing Company once again strongly recommends trying out and getting a feel for the AWS System before going straight to the field so you can get an understanding of what to expect. Some situations to try include:

- Driving the machine with both an empty and a full solution tank with AWS on.
- Drive the machine on hills, ensuring to take the proper precautions as stated in the *Safety and Precautions Section* elsewhere in this manual.
- Drive the machine at different turn angles and speeds to see how the limitations work.

NOTE: You will notice that if you go over any of the limitations, you can slow back down and the AWS system will automatically turn itself back on.

- **Auto Steer Machines Only:**
Notice how the machine feels when in AWS mode and switching from Auto Steer ON to OFF, especially when turning.
- Contact your local John Deere dealer with any questions you may have

regarding the operation of the AWS System.

HYDRAULIC SYSTEM COMPONENTS



Hydraulic Pumps (Mounted to the engine)

- Pressure Compensated (PC) Pump 1
- Pressure Compensated (PC) Pump 2
- Load Sense (LS) Pump
- Drive Pump



- PC Pump 1
- PC Pump 2
- LS Pump
- Drive Pump

Hydraulic Pumps
(View shown from top of machine)

The four Hydraulic Pumps (mounted to the engine) circulate hydraulic oil throughout the necessary systems and back through the oil cooler before returning it to the reservoir.

NOTICE

Operating the machine without adequate hydraulic oil level will result in system damage and will void the warranty.

If hydraulic oil level is too low for safe operation, a warning message will appear on the Machine Display to alert you of low hydraulic oil level. Press OK to acknowledge, shut down the engine immediately, and refill reservoir to proper level to avoid damage to the hydraulic systems.



Low Hydraulic Oil Level Warning Message
(Located on the Machine Display)

PC Pump 1

The PC Pump 1 powers the reversible fan motor and control valve.

PC Pump 2

The PC Pump 2 powers the high-pressure filter, power steering, attachments, and the AWS valve (if equipped).

LS Pump

The LS Pump powers the solution pump control valve.

Drive Pump

The Drive Pump powers the wheel motors.

Hydraulic Filtering/Cooling Components

- Oil Cooler
- Reservoir
- Return Filter
- Pressure Filter
- Case Drain Filter
- Breather Cap
- Level/Temp Sensor

NOTE: Refer to the Maintenance and Storage Section elsewhere in this manual for information on filling the hydraulic oil reservoir and replacing hydraulic filters.



Return Filter
(Located inside filter housing
on left-hand side of machine)
-Typical View



Oil Cooler
(Located near rear of machine -
open hood to access)
-Typical View



Pressure Filter
(Located beneath right-hand side of
machine - lower metal shield to access)
-Typical View



Hydraulic Oil Reservoir
(Located on left-hand side of
machine - open hood to access)
-Typical View



Case Drain Filter
(Located on left-hand side of machine)
-Typical View



Breather Cap
(Located on left-hand side of
machine near return filter housing)
-Typical View

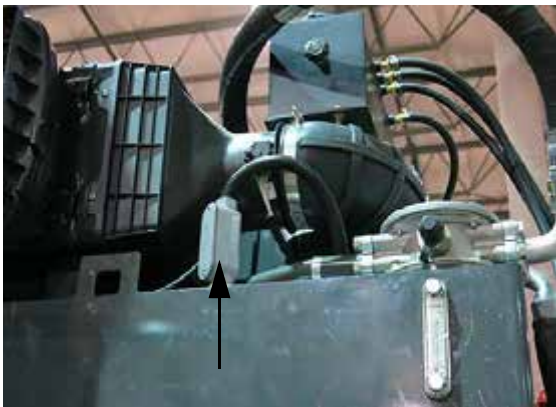

Level/Temp Sensor
(Located on top of hydraulic oil reservoir)
-Typical View

Hydraulic Spray System Components

- Solution Pump
- Solution Pump Control Manifold
- Boom Control Manifold



Solution Pump
(Located near center of machine)
-Typical View

** View shown from top of machine*



Solution Pump Control Manifold
(Located near center of machine)
-Typical View

** View shown from top of machine*

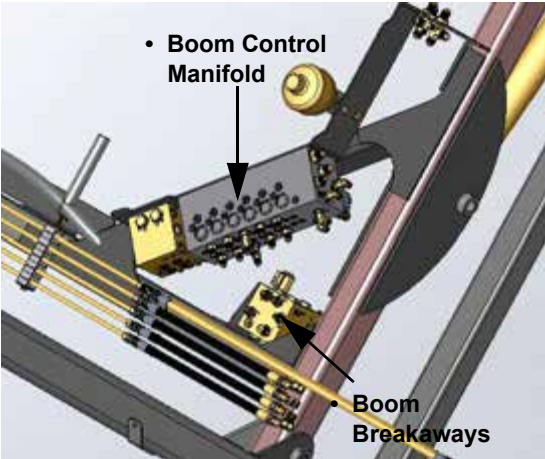

Boom Control Manifold and
NORAC Hydraulic Controller - *if equipped*
(Located on the boom lift arm assembly)
-Typical View
* 90-ft. Spray Boom Shown

Refer to the *Spray Systems Section* elsewhere in this manual for further information.

REVERSIBLE FAN

WARNING

Improper operation, maintenance, or repair of this product can be dangerous and may result in serious injury or death.

- Always use Hagie-approved parts and components. Failure to comply will result in voiding the 1-year parts warranty.
- Do not operate or perform any service on this product until you have read and understand the operation and maintenance information. Contact your local John Deere dealer for any additional information that you may require.
- The person(s) servicing the product may be unfamiliar with many of the systems or components of the product. Use caution when performing service. Knowledge of the product and components are important before the removal or disassembly of any component.



CUTTING/SEVERING OF FINGERS OR HAND.
DO NOT PLACE FINGERS OR
HAND NEAR MOVING FAN BLADES.

The Reversible Fan is an engine-mounted hydraulically driven constant pitch fan. Fan speed is controlled based on cooling demand. A signal is sent to the hydraulic valve block (mounted on the side of the fan assembly), which controls the speed and direction of the fan. The Reversible Fan can rotate the fan blades to change airflow direction and purge debris from the coolant pack by activating through the Machine Display Auxiliary Controls Page.

NOTE: The fan system reduces power and fuel consumption of the engine when full airflow is not required to keep the engine cool.

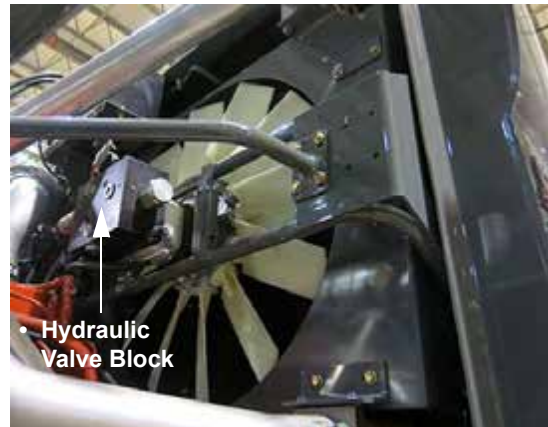

Reversible Fan
(Located near the rear of machine
- open hood to access)
-Typical View

To Activate the Reversible Fan

Refer to “Machine Display” provided in the *Cab Section* elsewhere in this manual for complete operating instructions.

Before Starting the Engine

1. Ensure all hoses and wires are adequately secured and routed away from the fan operating area.
2. Ensure all tools have been removed from the engine compartment, including the top side of the radiator and inside of the shroud before the fan guards are installed. Obstacles in the path of rotation can interfere with movement of the fan and can result in damage to the fan blades, fan hub, and radiator core.
3. Inspect the radiator shroud mounting bolts to ensure that the radiator and shroud are firmly secured and unable to move during operation of the machine. Loose shroud bolts can allow the fan shroud to move into the path of the rotating blades and loose radiator mounting bolts can allow the radiator to flex in position, allowing the shroud to come into contact with the rotating fan blades.
4. Ensure all fan guards have been installed and firmly secured into place. The Reversible Fan creates an abundant amount of airflow in both cooling and cleaning mode operation. The result of this airflow is a strong vacuum effect that can suck in items that are located inside or around the engine compartment fan.
5. To ensure maximum efficiency, start with a clean cooling system free of debris, paying particular attention to the stacked cooler core(s).

Service and Maintenance

 **WARNING**

Ensure the Battery Disconnect Switch is OFF before performing any service on the fan. Failure to comply may result in engine turnover, serious injury, or death.

Under normal operating conditions, the Reversible Fan does not require scheduled maintenance (other than lubrication) and is built to provide thousands of hours of trouble-free service.

In moderate to extreme operating conditions, a visual inspection of moving parts is recommended from time to time to safeguard against fan blade damage, which could lead to equipment and/or other damage.

LADDER

 **CAUTION**

Upright ladder is not a service platform or step.

- DO NOT step on the ladder while in the upright position.
- DO NOT lower the ladder while anyone is on the ground near the machine.
- DO NOT attempt to lower the ladder from ground level.

Failure to comply may result in injury.

To Lower the Ladder

⚠ CAUTION

Ensure the Hydrostatic Drive Control Handle is in the NEUTRAL position before engaging the parking brake. Failure to comply may result in personal injury and/or machine damage.

- **To lower the Ladder**, move the Hydrostatic Drive Control Handle to the NEUTRAL position.



Hydrostatic Drive Control Handle
-Typical View

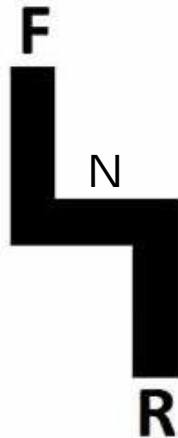

- Slide the red safety lever (located on the Parking Brake Switch) DOWN (Back) and press top of switch DOWN.



Parking Brake Switch
(Located near the Hydrostatic
Drive Control Handle)
-Typical View



Ladder
-Typical View

NOTE: When the Parking Brake is engaged, a parking brake indicator (located on the top left-hand side of each Machine Display page) and the Parking Brake Switch will illuminate.

To Raise the Ladder

- **To raise the Ladder**, press and hold the Decel Pedal (located to the lower right-hand side of the steering column) and press the Parking Brake Switch in the DOWN (Off) position.

NOTE: When the Ladder is raised, the Parking Brake will be OFF (disengaged).



SECTION 6 – ELECTRICAL SYSTEMS

⚠ WARNING

CALIFORNIA PROPOSITION 65 WARNING

WARNING: Diesel engine exhaust and some of its constituents are known to the State of California to cause cancer and birth defects or other reproductive harm.

WARNING: Battery posts, terminals, and related accessories contain lead and lead compounds, and chemicals known to the State of California to cause cancer and birth defects or other reproductive harm.

Access

The batteries are located on the left-hand side of machine. Open hood to access.

NOTE: When servicing the electrical system, always remove the batteries (removing the ground cable first). When reinstalling the batteries, connect the ground cable last.



Battery Access

(Located on the left-hand side of machine - open hood to access)
-Typical View

BATTERIES

⚠ CAUTION

Batteries contain sulfuric acid. Avoid contact with skin, eyes, or clothing. Do not inhale fumes or ingest liquid. Batteries contain gases which can explode. Keep sparks and flame away while servicing.

⚠ CAUTION

Disconnect the battery when servicing any part of the electrical system. Failure to comply may result in injury and property damage.

NOTICE

Use a sturdy stationary ladder to safely access/service the batteries.

Charging

⚠ CAUTION

Electrical system is 12-volt negative ground. When using booster with jumper cables, precautions must be taken to prevent personal injury or damage to electrical parts.

1. Attach one end of jumper cable to positive booster terminal and other end to positive terminal of vehicle battery connected to starter motor.
2. Attach one end of second cable to negative booster terminal and other end to vehicle frame away from battery.
3. To remove cables, reverse above sequence exactly to avoid sparks. See operator's manual for additional information.

810296

For your convenience, a set of Auxiliary Battery Charging Posts are located on the rear mainframe for ease of charging the batteries.



Auxiliary Battery Charging Posts
(Located on the rear mainframe)
-Typical View

Connect your charging cables to the Auxiliary Battery Charging Posts just as you would to the battery - positive cable to the positive terminal, and negative cable to the negative terminal.

NOTE: Keep these terminals clean and their caps in place when not in use.

NOTICE

To ensure sufficient electrical contact, battery terminal connections should be as clean and tight as possible.

Cleaning

- Disconnect the battery cables from the batteries.
- Remove any corrosion with a wire brush or battery post brush.
- Wash the battery cable connections and posts with a mild baking soda and ammonia solution.
- Apply grease (or dielectric grease) to prevent corrosion.
- Reconnect the batteries, ensuring connections are tight.
- Clean every 100 hours of operation.

Replacement

Install replacement batteries with ratings equivalent to the following specifications:

- **Voltage** - 12V only

- **CCA** - 30 seconds at 0° F. (950)
- **Reserve Capacity** - 185 minutes at 25 amps

Storage

Refer to “Storage” provided in the *Maintenance and Storage Section* elsewhere in this manual for further information.

BATTERY DISCONNECT SWITCH

WARNING

DO NOT use the Battery Disconnect Switch as a safety device when performing work to the electrical system. Disconnect the negative battery cable before servicing.



Your machine is equipped with a Battery Disconnect Switch (located on the rear mainframe) to de-energize battery power, cutting all electrical power to the engine.

- Rotate the Battery Disconnect Switch to the ON (clockwise) or OFF (counter-clockwise) positions to operate.



Battery Disconnect Switch
(Located on the rear mainframe)
-Typical View

NOTE: Turn the Battery Disconnect Switch OFF during long storage periods.

*NOTE: **Tier 4 Final Engines** - Allow the Diesel Exhaust Fluid (DEF) Recirculation Pump to finish running before turning the Battery Disconnect Switch off.*

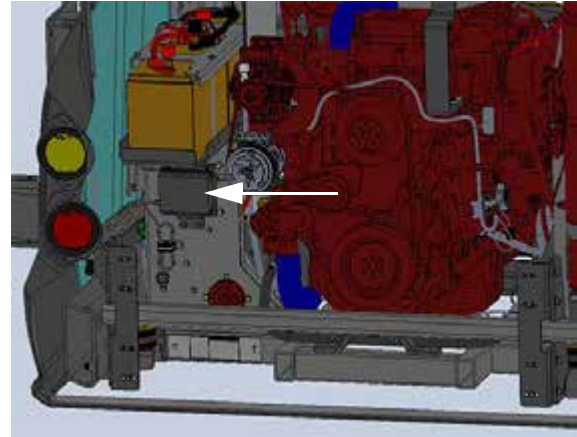

Battery Tender
(Mounted on engine skid above
the battery disconnect switch)
-Typical View

BATTERY TENDER

-If Equipped

Your machine may be equipped with a Battery Tender (mounted on the engine skid above the battery disconnect switch) to maintain battery charge during extended storage periods. The Battery Tender is factory-installed and comes already connected to the batteries.

If you wish to trickle charge the batteries, an extension cord must be brought to the machine and plugged into the Battery Tender's 120-volt AC plug (standard electrical plug). The Battery Tender can be plugged in indefinitely as it monitors battery charge and prevents itself from overcharging the batteries.

FUSES AND RELAYS

Interior Cab Functions



Circuit Breakers/Fuses (Interior)
(Located rear of side console -
remove tray to access)
-Typical View

The following label is affixed beneath the side console (remove tray to access) and provides information on component fuse/relay amperage ratings.

<p>Mini-Fuses F01 - HVAC Power (25A) F02 - A-Post Gauges (5A) F03 - Spray Section Keypad (5A) F04 - Radio (10A) F05 - Wiper/Washer (15A) F06 - Aux Sw Pwr 1 (15A) F07 - Pod Sw Pwr (5A) F08 - Sw Pwr Signal (3A) F09 - Chassis XA2-0 Pwr (20A) F10 - Steering Column/Bat Pwr (20A) F11 - Rotating Beacons (15A) F12 - Attach Vlv Pwr 2 (20A)</p>	<p>Mini-Fuses F26 - EDP Bat Power (5A) F27 - Ignition Key (10A) F28 - Steering Column Pwr (15A) F29 - Pod Bat Pwr (10A) F30 - Power Outlets (20A) F31 - Power Con 1 & 2 Bat Pwr (20A) F32 - Power Con 2 Sw Pwr (20A) F33 - Aux Sw Pwr 2 (15A) F34 - Seat Power (20A) F35 - Aux Sw Pwr 3 (20A) F36 - Pwr Con 1 Sw Pwr (20A) F37 - SASA Kick-out (15A)</p>
<p>F13 - Chassis XA2-1 Pwr (20A) F14 - Attach Vlv Pwr 1 (20A) F15 - Attach Vlv Pwr 3 (20A) F16 - Attach Mod Pwr 1 (20A) F17 - Attach Mod Pwr 2 (20A) F18 - Chas S-XA2-0 Pwr (20A) F19 - Attach Mod Pwr 3 (20A) F20 - Attach Mod Pwr 4 (20A) F21 - Field Lights 1 (15A) F22 - Aux Relay 1 (10A) F23 - Field Lights 2 (15A) F24 - Start Relay (10A) F25 - Radio/Dome Bat Pwr (5A)</p> <p style="text-align: center;">HAGIE</p>	<p>F38 - PRI-Con Mod Pwr (20A) F39 - SEC-Con Mod Pwr (20A) F40 - HVAC Clutch (15A)</p> <p>Relays CR01 - Rotating Beacon Lights CR02 - Wiper CR03 - Wiper/Washer CR04 - Field Lights 1 CR05 - Field Lights 2 CR06 - Start Relay CR07 - Aux Relay 1 CR08 - SASA Kick-out</p> <p>292629 32281-0 (LR-0)</p>

Exterior Lights/System Functions



Circuit Breakers/Fuses (Exterior)
(Located beneath cab -
remove panel to access)
-Typical View

The following label is affixed beneath the cab and provides information on component fuse/
relay amperage ratings.

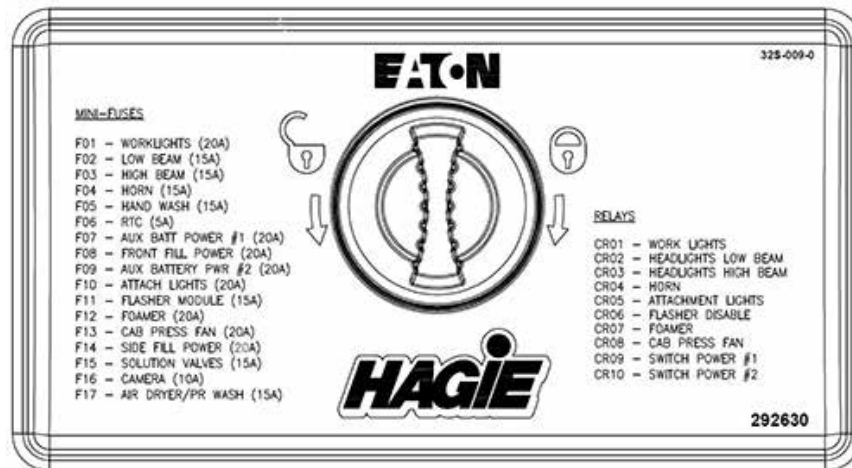

Solution Pump Relays

The following relays are located within the solution pump relay box listed from top down.

Function	Description/Rating
Solution Pump Stop Relay	12V SPST Relay - 35 Amp
Solution Pump Signal Relay	12V SPDT Micro Relay - 35 Amp
Solution Pump Return Relay	12V SPDT Micro Relay - 35 Amp



Solution Pump Relay Box
(Located beneath front end of cab - lower panel to access)
-Typical View

Tier 4 Final Engine Fuses and Relays

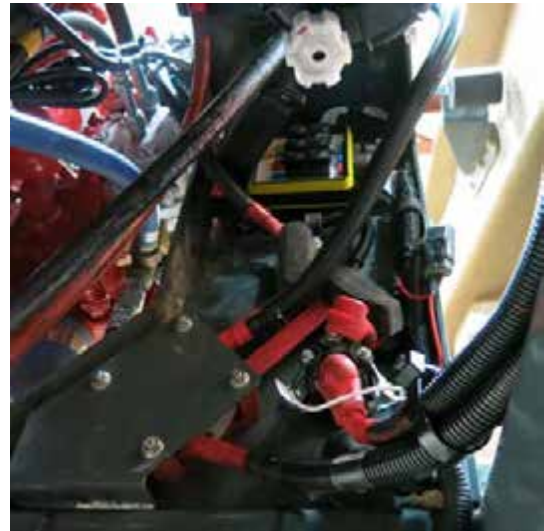

Tier 4 Final Engine Fuse/Relay Block
(Located beneath batteries on the rear left-hand side of machine)
-Typical View

The following labels are affixed near the engine fuse/relay block and provide information on component fuse/relay amperage ratings.

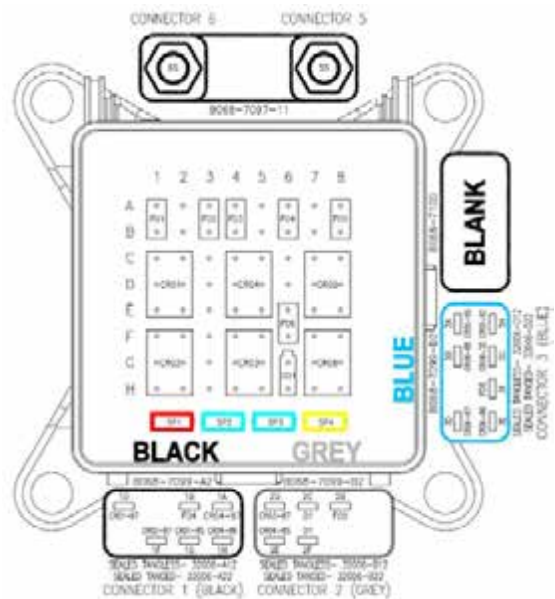

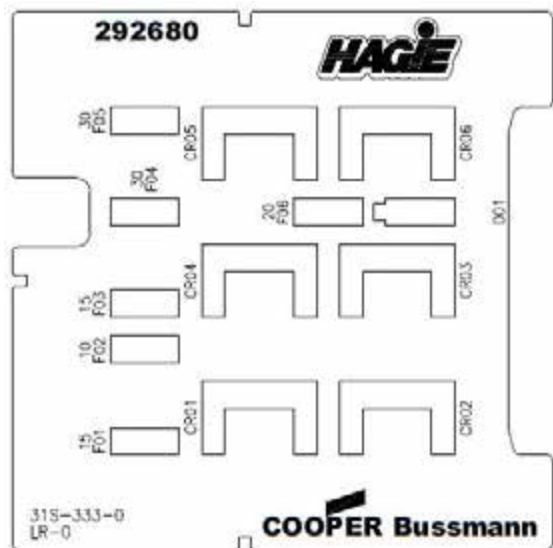

Device Placement			
Pos.	Ref.	Device	Part No.
D1	F01	Mini Fuse	ATM-15UNP-PEC
D2	F02	Mini Fuse	ATM-10UNP-PEC
D3	F03	Mini Fuse	ATM-15UNP-PEC
D4	F04	Mini Fuse	ATM-30UNP-PEC
D5	F05	Mini Fuse	ATM-30UNP-PEC
D6	R1	12V, 35A 5-Pin Micro	B120-7025
D7	R4	12V, 35A 5-Pin Micro	B120-7025
D8	R5	12V, 35A 5-Pin Micro	B120-7025
D9	F06	Mini Fuse	ATM-20UNP-PEC
D10	R2	12V, 35A 5-Pin Micro	B120-7025
D11	R3	12V, 35A 5-Pin Micro	B120-7025
D12	R6	12V, 35A 5-Pin Micro	B120-7025
D13	D01	6A Diode	22903-6V

Spare Device Placement		
Position	Device	Part No.
SP1	Mini Fuse	ATM-10UNP-PEC
SP2	Mini Fuse	ATM-15UNP-PEC
SP3	Mini Fuse	ATM-20UNP-PEC
SP4	Mini Fuse	ATM-30UNP-PEC

Device Totals		
Device	Part No.	Amount
Mini Fuse	ATM-10UNP-PEC	2
Mini Fuse	ATM-15UNP-PEC	3
Mini Fuse	ATM-20UNP-PEC	2
Mini Fuse	ATM-30UNP-PEC	3
6A Diode	22903-6V	1
12V, 35A 5-Pin Micro	B120-7025	6

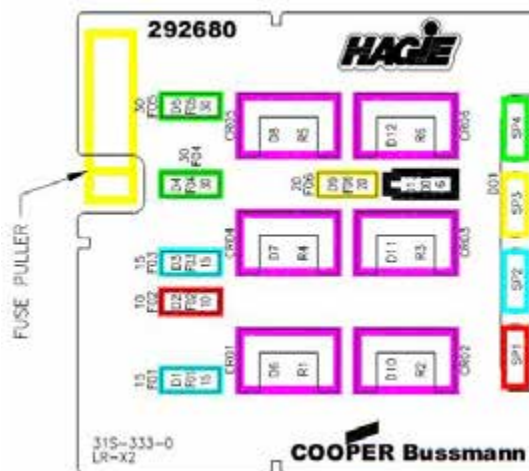



Hood Actuator Fuse



Hood Actuator Fuse
(Located beneath rear
left-hand side of machine)
-Typical View



FUSE AND RELAY RATINGS

Fuses and Relays - Exterior (Located beneath cab) <i>* Remove panel to access</i>		
Fuse	Rating (Amps)	Function
F01	20	Work Lights
F02	15	Highway Lights (Low Beam)
F03	15	Highway Lights (High Beam)
F04	15	Horn
F05	15	Hand Wash
F06	5	RTC Battery Power
F07	20	Auxiliary Battery Power 1
F08	20	Front-Fill
F09	20	Auxiliary Battery Power 2
F10	20	Attachment Lights
F11	15	Flasher Module
F12	20	Foam Marker
F13	20	Cab Pressure Fan
F14	20	Side-Fill
F15	15	Solution Valves
F16	10	Camera
F17	15	Air Dryer
Relay	Ratings (Amps)	Function
CR01	35	Work Lights
CR02	35	Headlights (Low Beam)
CR03	35	Headlights (High Beam)
CR04	35	Horn
CR05	35	Attachment Lights
CR06	35	Flasher Disable
CR07	35	Foam Marker
CR08	35	Cab Pressure Fan
CR09	35	Switch Power 1



CR10	35	Switch Power 2
Fuses and Relays - Interior (Located rear of side console) <i>* Remove tray to access</i>		
Fuse	Rating (Amps)	Function
F01	25	HVAC Power
F02	5	A-Post Gauges
F03	5	Boom Solution Valves (Spray Section Keypad)
F04	10	Radio Power
F05	15	Wiper/Washer Power
F06	15	Heated Mirrors
F07	5	Pod Switched Power
F08	3	Power Mirrors/Power Signal for Auxiliary Switched Power (beneath cab)
F09	20	Chassis XA2-0 Power
F10	20	Steering Column/Battery Power
F11	15	Rotating Beacons
F12	20	Attachment Valve Power 2
F13	20	Chassis XA2-1 Power
F14	20	Attachment Valve Power 1
F15	20	Attachment Valve Power 3
F16	20	Attachment Module 1 Power
F17	20	Attachment Module 2 Power
F18	20	Chassis S-XA2-0 Power
F19	20	Attachment Module 3 Power
F20	20	Attachment Module 4 Power
F21	15	Field Lights 1
F22	10	Auxiliary Relay 1
F23	15	Field Lights 2
F24	10	Start Relay
F25	5	Radio/Dome Light
F26	5	EDP Battery Power
F27	10	Ignition Key
F28	15	Steering Column Power



F29	10	Pod Battery Power
F30	20	Power Outlets
F31	20	Power Connector 1 and 2 Battery Power
F32	20	Power Connector 2/Switched Power
F33	15	Side Wipers
F34	20	Seat Power
F35	20	Deluge Pump
F36	20	Power Connector 1/Switched Power
F37	15	SASA Kick-out Signal
F38	20	Primary Controller Power (beneath cab)
F39	20	Secondary Controller Power (beneath cab)
F40	15	HVAC Clutch
Relay	Rating (Amps)	Function
CR01	35	Rotating Beacon Lights
CR02	35	Wiper
CR03	35	Wiper/Washer
CR04	35	Field Lights 1
CR05	20	Field Lights 2
CR06	20	Start Relay
CR07	35	Auxiliary Relay 1
CR08	20	SASA Kick-out Relay
Relays - External Harness (Located beneath right-hand side of cab)		
	Rating (Amps)	Function
	30A/50A	Solution Pump Signal
	30A/50A	Solution Pump Return
	30A/50A	Solution Pump Enable
Fuses and Relays - Tier 4 Final Engine (Located on engine skid beneath batteries)		
Fuse (Mini)	Rating (Amps)	Function
F01	15	DEF Line
F02	10	Aftertreatment

F03	15	DEF Module
F04	30	Engine ECM
F05	30	Start
F06	20	Auxiliary Battery Power
Diode	Rating (Amps)	Function
D01	6	Grid Heater
Relay	Rating (Amps)	Function
CR01		DEF Line 1
CR01		DEF Line 2
CR03		DEF Line 3
CR04		Aftertreatment
CR05		DEF Module
CR06		Starter

VIDEO CAMERA INPUT CONNECTIONS

Your machine is equipped with a Video Camera (operated through the Machine Display) for your convenience when operating the machine in reverse and is located on the rear of the sprayer.

Two additional Video Camera Input Connections (located beneath cab - remove front panel to access) are provided for the installation of add-on video camera(s).



Video Camera Input Connections
(Located beneath cab -
remove front panel to access)
-Typical View

Refer to “Machine Display” provided in the *Cab Section* elsewhere in this manual for further information.

Belly Camera Input Connections

Additional input connections are provided for the Belly Camera. Remove panel beneath side console to access.



Belly Camera Input Connections
(Located beneath side console
- remove panel to access)
-Typical View

Refer to the camera manufacturer's
operation manual for further information.

SPRAY BOOMS - 90/100'

The spray booms are controlled by an electro-hydraulic system. This system consists of operator-manipulated switches (located on the side console and the hydrostatic drive control handle) and hydraulic cylinders (attached to the booms), which provide lift, level, horizontal extension, and vertical extension.



CAUTION

When operating or positioning the booms, observe the following safety precautions. Failure to comply may result in injury or equipment damage.

- Do not unfold/fold boom extensions when main boom is in cradle.
- Do not operate machine with one boom wing out of cradle and the other boom wing in cradle.
- Ensure booms are folded and in cradle before transporting the machine.

WARNING

When operating or positioning the booms, observe the following safety precautions:

- Monitor both sides of the boom during fold procedure.
- Cradle booms when leaving the machine unattended.
- Ensure booms are folded when cradled.
- Select a safe area before unfolding/folding the booms.
- Clear area of personnel.
- Check for overhead obstructions.
- Do not unfold/fold booms near power lines. Contact with power lines can result in serious injury or death.
- Spray equipment is designed for FIELD USE ONLY. Do not attempt to use machinery for anything other than it's intended purpose.

WARNING

Hydraulic and electrical control systems are optimized for use of the spray boom attachment. Any modification to these systems may lead to unintended and uncontrolled motion. DO NOT install add-on control systems that are not approved by Hagie Manufacturing Company.

Power Lines

Hagie Manufacturing Company cannot stress enough that extreme caution must be taken when operating equipment near power lines. Ensure there is more than sufficient clearance when transporting, unfolding and folding the boom, or spraying near power lines.



As a safety precaution, a Power Line Warning Message will appear on the Machine Display before extending the outer boom extensions. Press ACKNOWLEDGE showing that you have acknowledged that there are no overhead power lines or obstructions before proceeding.



Power Line Warning Message
 (Located on the Machine Display)

Hydraulically folding the extensions of a 60/80/90-ft. or 60/100-ft. spray boom, adjusting the spray valves, and shutting off the outer sections essentially turns it into a 60-ft. spray boom.

Manually folding the outer extensions of a 60/80/90-ft. spray boom, adjusting the spray valves, and shutting off the outer sections turns it into an 80-ft. spray boom (see the following illustrations).

Refer to the Spray System Console calibration information provided elsewhere in this section for further information.

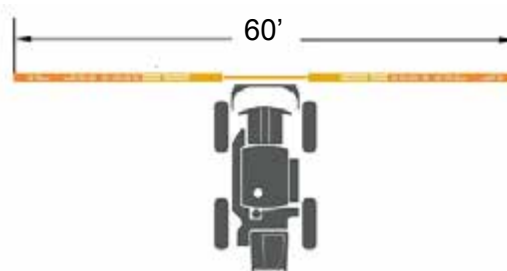

60/80/90' System with
 Extensions Folded Over

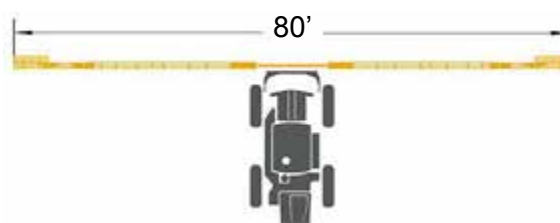

60/80/90' System with Outer
 Extensions Manually Folded Forward

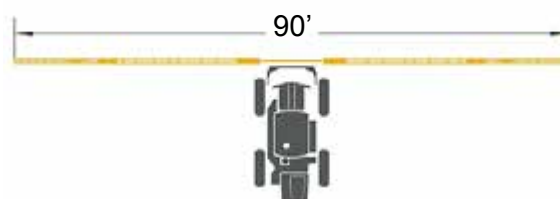

60/80/90' System with all
 Extensions Folded Out

Spray Boom Components

- (A) - Lift Cylinder
- (B) - Transom
- (C) - Main Pivot Cylinder
- (D) - Level Cylinder
- (E) - Lift Arm
- (F) - Main Boom Section
- (G) - Boom Extension Cylinder
- (H) - Boom Extension (Outer Boom Section)
- (I) - Boom Breakaway Cylinder

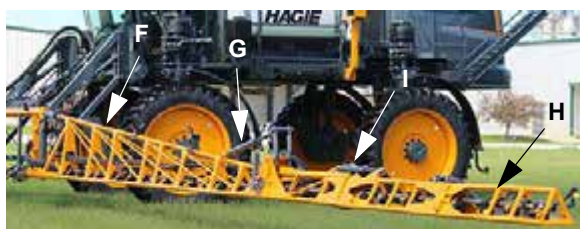

Hydraulic Breakaway Circuit

(90 and 100-ft. Spray Booms)

90 and 100-ft. spray booms are equipped with a Hydraulic Breakaway Circuit. When folded out as an 80, 90, or 100-ft. spray boom, a one-way hydraulic circuit (located on the outer boom section) provides outer boom breakaway functions.



Outer Boom Breakaway
-Typical View

When the outer boom section breaks away, it will return to the “spray” position (after it has cleared the hazard), but will not be in the locked position.

To Reset the Outer Boom Breakaway:

- Press and hold the Reset Breakaways Button (Located on the Machine Display Auxiliary Controls Page) until the outer boom sections are in the LOCKED position.

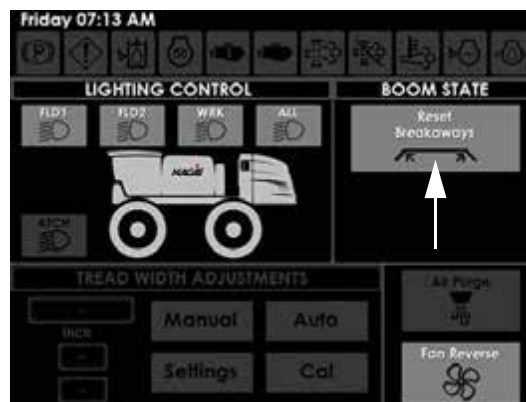

Reset Breakaways Button
(Located on the Machine Display
Auxiliary Page)

NOTE: On 90-ft. spray booms, the main breakaways cannot be folded unless machine speed is less than 5 mph (8 km/h).

Boom Fold Procedure

⚠ CAUTION

Booms will unfold vertically even if they are still in the boom cradle or are not horizontally extended.

NOTICE

Do not move the transom up or down during boom fold procedure. Failure to comply may result in severe damage to the boom wing structures.

NOTICE

Do not lower the main lift while the boom is in cradle. Failure to comply will result in property damage.

Unfolding/Extending the Boom

NOTE: Ensure the Hydrostatic Drive Control Handle is in the NEUTRAL position. If the machine is put in gear during fold operation, boom movement will stop.

1. Press and hold the corresponding Left and Right-Hand Boom Switches (located on the Hydrostatic Drive Control Handle) in the UP position to raise the level cylinders all the way up.



Left and Right-Hand Boom Switches
(Located on the Hydrostatic
Drive Control Handle)
-Typical View

2. Press and hold the corresponding Left and Right-Hand Boom Switches in the OUT position to unfold the main boom sections until they come to a complete stop.
3. Lower the level cylinders until the boom is parallel with the ground.
4. Press and hold the Boom Extension Switch (located on the side console) in

the UP position to unfold the left and right boom extensions all the way OUT.

NOTE: Both left and right boom extensions move simultaneously when the Boom Extension Switch is pressed.



Boom Extension Switch
(Located on the side console)
-Typical View

Folding/Retracting the Boom

NOTE: Ensure the Hydrostatic Drive Control Handle is in the NEUTRAL position. If the machine is put in gear during fold operation, boom movement will stop.

1. Lower the level cylinders until the boom is parallel with the ground.
2. Press and hold the Boom Extension Switch (located on the side console) in the DOWN position to fold the left and right boom extensions all the way IN.

NOTE: Both left and right boom extensions move simultaneously when the Boom Extension Switch is pressed.



Boom Extension Switch
(Located on the side console)
-Typical View

3. Press and hold the corresponding Left and Right-Hand Boom Switches (located on the Hydrostatic Drive Control Handle) in the UP position to raise the level cylinders all the way up.

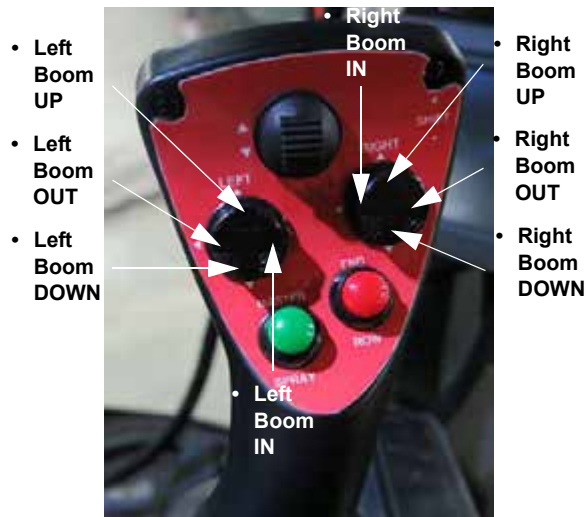

Left and Right-Hand Boom Switches
(Located on the Hydrostatic
Drive Control Handle)
-Typical View

4. Press and hold the corresponding Left and Right-Hand Boom Switches in the IN position until the main boom sections are aligned with boom cradles.
5. Lower the level cylinders until the boom sections are seated in the boom cradles.

Manual Fold

(90-ft. Spray Boom to an 80-ft. Spray Boom)

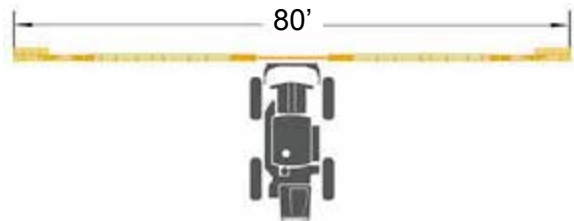

60/80/90' System with Outer
Extensions Manually Folded Forward

1. Press Boom Solution Valve Switches - Sections 1 and 9 (located on the side console) to the OFF position.



Boom Solution Valve
Switches - Sections 1 and 9
(Located on the side console)
-Typical View

2. Remove the Securement Bolt (located on the back side of boom) and hinge outer section forward.



Securement Bolt
(Located on the back side of boom)
-Typical View



3. Secure into place with the rear Securement Bolt.
4. Repeat Steps 2-3 on opposite side of machine.

SOLUTION SYSTEM COMPONENTS

The Solution System is a constantly monitored, continuously adjusted computer-controlled system. The cab-mounted digital spray system console receives information from various inputs to help determine gallons per acre (GPA)/liters per hectare (l/ha) and gallons per minute (GPM)/liters per minute (l/min).

Please read and understand the information provided in this manual, as well as the spray system console manufacturer's operation manual before operating the Solution System. The following information refers to components of the Solution System and is not intended to replace the manufacturer's operating instructions.

- Solution Tank
- Solution Pump
- Solution Pump Switch
- Flow Meter
- Pressure Gauge
- Solution Tank Valve
- Main Tank Valve Switch
- Boom Solution Valve Switches
- Section Indicator Display
- Boom Solution Valve Indicators (Transom), if equipped
- Rate Control Switches
- Pump Speed/Rate Switches
- Master Spray Switch
- Spray System Console
- Wet Booms
- Nozzle Bodies
- Section Strainers (if equipped)
- Solution Line Strainer

Solution Tank

The 2000-gallon (7570 L) stainless steel Solution Tank (located at the center of the machine) is equipped with a spin ball-type rinse system (two rotating rinse balls inside the tank). A mechanical sight gauge is located behind the left-hand side of cab to visually check solution level at all times.



Solution Tank
-Typical View

Solution Pump

Hypro® 9306-HM1C-BU w/silicon carbide seals, 3” (7.6 cm) inlet/2” (5.1 cm) outlet plumbing

The Solution Pump (located beneath center of machine) is a centrifugal-type hydraulically driven pump that is controlled by the Solution Pump Control Valve and the Spray System Console. The pump draws solution out of the tank at the rate determined during calibration. It dispenses solution through the many valves and hoses that make up the Spray System.

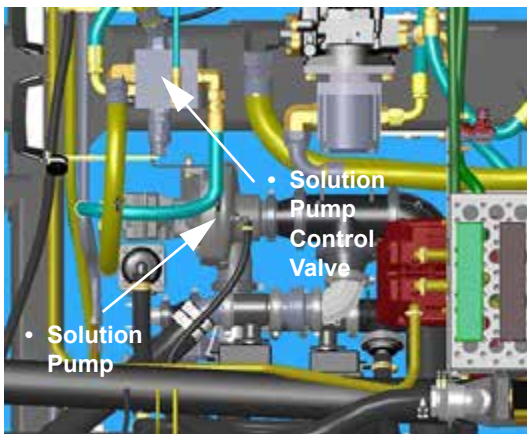

Solution Pump and
Solution Pump Control Valve
(Located beneath center of machine)
-Typical View
* View shown from top of machine

Refer to the Spray System Console manufacturer’s operation manual for further information on solution pump control.

Solution Pump Switch

The Solution Pump Switch (located on the side console) is used to turn on/off the Solution Pump.

NOTE: Leaving the Solution Pump Switch in the ON position without flow may result in system damage.

- Press the Solution Pump Switch in the UP position to turn ON (enable).
- Press the Solution Pump Switch in the DOWN position to turn OFF (disable).



Solution Pump Switch
(Located on the side console)
-Typical View

NOTE: When the Solution Pump is ON, a Solution Pump Indicator (located on the Machine Display Home Page - Field Mode) will illuminate.



Solution Pump Indicator
(Located on the Machine Display Home Page - Field Mode)

Flow Meter

(ARAG® Orion)

The Flow Meter (located beneath the right-hand side of machine) is an electromagnetic-type with no internal moving parts, which monitors solution flow and sends information back to the Spray System Console.

NOTE: Flow Meter Usable Range = 3-190 GPM (11.4-719.2 l/min).

NOTE: Flow Meter Calibration = 378 pulses/ per gallon (standard volume system). Calibration is listed on the flow meter tag and may vary depending on options and available equipment.

NOTE: Raven Controllers - Flow Meter Calibration = 3,780 pulses/per 10 gallons.

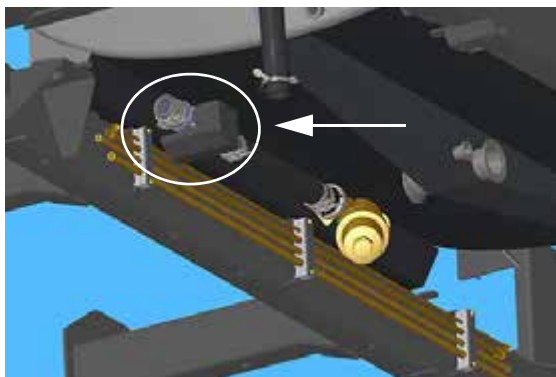

Flow Meter
(Located beneath the
right-hand side of machine)
-Typical View

Pressure Gauge

The Pressure Gauge (mounted on the boom) gives a constant visual display of solution pressure being applied (measured in PSI).

NOTE: Pressure will vary according to speed, application, rate, tip size, etc.



Pressure Gauge
(Mounted on boom)
-Typical View

Solution Tank Valve (Main Tank)

The Solution Tank Valve (located beneath the solution tank on underside of machine) is an electric tank shut-off valve. This valve is controlled by the Main Tank Valve Switch (located on the side console).



Solution Tank Valve
(Located beneath the solution
tank on underside of machine)
-Typical View

Main Tank Valve Switch

The Main Tank Valve Switch (located on the side console) controls the solution tank valve.

- Press the Main Tank Valve Switch in the UP (On) position to open the solution tank valve.

- Press the Main Tank Valve Switch in the DOWN (Off) position to close the solution tank valve.



Main Tank Valve Switch
(Located on the side console)
-Typical View

NOTE: Main Tank Valve status (OPEN or CLOSED) is displayed on the Machine Display Home Page - Field Mode.



Main Tank Valve Status Indicator
(Located on the Machine Display Home Page - Field Mode)

Boom Solution Valve Switches

The spray booms are divided into sections that are independently supplied with solution and can be turned on or off individually. The electrically-operated Boom Solution Valves are controlled by the Boom Solution Valve Switches (located on the side console).

- Press the Boom Solution Valve Switches to turn ON. Press again to turn OFF.

NOTE: Each Boom Solution Valve Switch is equipped with an indicator light and will illuminate when the corresponding Boom Solution Valve is OFF.



Boom Solution Valve Switches
(Located on the side console)
-Typical View

Section Indicator Display

The Section Indicator Display (located on the cab headliner) allows you to view system status for the following:

- (1) - Master Spray Indicator (illuminates when ON).
- (2) - Fence Row Indicators (illuminate when ON).
- (9) - Spray Section Indicators (illuminate when OFF).
- (1) - Rear Wheel Nozzle Indicator (illuminates when ON).

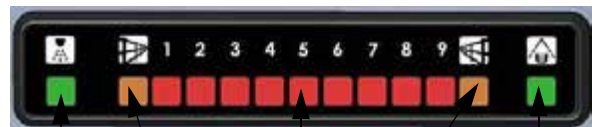

- Master Spray
- Left Fence Row
- Spray Section
- Right Fence Row
- Rear Wheel Nozzle

Section Indicator Display
(Located on the cab headliner)
-Typical View

Boom Solution Valve Indicators (Transom)

-If Equipped

Your machine may be equipped with transom-mounted Boom Solution Valve Indicators (located on the center of the transom), which allow you to view system status for the following:

- (2) - Fence Row Indicators (illuminate when ON).
- (1) - Master Spray Indicator (illuminates when ON).
- (9) - Spray Section Indicators (illuminate when OFF).



Boom Solution Valve Indicators
(Located on transom)
-Typical View

Rate Control Switches

The Rate Control Switches (located on the side console) control the rate in which solution is applied through the spray booms.

- Press ENABLE to allow the rate controller to control the application rate.
- Press MAN (Manual) to control application rate from the section keypad.
- Press ENABLE and MAN to enable manual rate control through the rate controller.



Rate Control Switches
(Located on the side console)
-Typical View

NOTE: When “MAN” is selected, press the Pump Speed/Rate Switches (located on the side console) to increase (+) or decrease (-) application rate. Current solution pump speed is displayed below the Solution Pump Indicator (located on the Machine Display Home Page - Field Mode).

Pump Speed/Rate Switches

The Pump Speed/Rate Switches (located on the side console) control the flow rate through the spray system.

NOTE: These switches are enabled when the “MAN” Rate Control Switch (located on the side console) is previously selected.

- Press “+” to INCREASE Solution Pump speed.
- Press “-” to DECREASE Solution Pump speed.



Pump Speed/Rate Switches
(Located on the side console)
-Typical View

NOTE: Increasing or decreasing pump speed will change the application rate through the rate controller.

Master Spray Switch

Boom Solution Valve Switches are controlled by the Master Spray Switch (located on the Hydrostatic Drive Control Handle) and must be ON to open the electronically-operated Boom Solution Valves. This allows you to turn all of the Boom Solution Valves on or off at the same time.



Master Spray Switch
(Located on the Hydrostatic Drive Control Handle)
-Typical View

NOTE: When the Master Spray Switch is ON, a Master Spray Indicator (located on the Machine Display Home Page - Field Mode) will illuminate.



Master Spray Indicator
(Located on the Machine Display Home Page - Field Mode)

Spray System Console

The spray system is controlled by the Spray System Console and the Solution Pump Control Valve. The system receives

data and automatically makes adjustments based on the target rate of application set by the operator.

Refer to the Spray System Console manufacturer's operation manual for complete calibration and operating instructions.



Spray System Console
-Typical View

Wet Boom

The 9-section Wet Boom on your machine is featured with 1" (2.5 cm) schedule 5 stainless plumbing and delivers solution directly to the spray nozzles, which allows for ease of flushing and cleaning of the boom, as well as decreased contamination/plugging of nozzles.

The Wet Booms are equipped with Hypro® Express end caps on the end of the boom tubing, which aid in eliminating trapped air from the boom by allowing air to escape through the nozzle body, reducing nozzle turn-off time. The end caps are equipped with a "quick-release" feature to assist in flushing the Wet Boom tubes.



Wet Boom Plumbing
-Typical View



Hypro Express End Cap
-Typical View

Refer to "Spray Booms" elsewhere in this section for further information.

Nozzle Bodies

Nozzle Bodies are located throughout the boom and consist of a spray tip, gasket, and cap. The spray tip breaks the solution into droplets of correct size and forms a uniform spray pattern.



Nozzle Body
(Located throughout boom)
-Typical View

Visit www.teejet.com for further information.

Section Strainers

-If Equipped (80-Mesh Strainer Screens)

Section Strainers are located throughout each boom section and filter impurities to aid in the avoidance of spray nozzle buildup.



Section Strainers
(Located throughout each boom section)
-Typical View

Refer to “Service - Filters” provided in the *Maintenance and Storage Section* elsewhere in this manual for maintenance information.

Solution Line Strainer

(50-Mesh Strainer Screen)

A Solution Line Strainer is located beneath the center right-hand side of machine and is the main strainer to filter solution system impurities and maintain consistent application rates.



Solution Line Strainer
(Located beneath the center
right-hand side of machine)
-Typical View

Refer to “Service - Filters” provided in the *Maintenance and Storage Section* elsewhere in this manual for maintenance information.

SOLUTION SYSTEM - OPERATION

NOTICE

The Solution System has been tested using RV-type antifreeze. Fill solution tank with fresh water and drain before initial use.

NOTICE

Never attempt to operate the spray system without solution in the tank. Failure to comply will cause severe equipment damage and will void the warranty.

NOTE: Ensure the Master Spray Switch (located on the Hydrostatic Drive Control Handle) is in the OFF position before activating the Solution Pump Switch or the Boom Solution Valve Switches, unless you are ready to begin spray application.

Getting Started

1. Calibrate the Spray System Console (refer to the manufacturer’s operation manual for calibration instructions).
2. Ensure there is adequate amount of solution in the tank.
3. Engage the parking brake.
4. Start the engine.
5. Press the Field/Road Button (located on the Machine Display Home Page) and change the machine’s drive state to FIELD.

NOTE: The drive state of the machine cannot be changed unless the Hydrostatic Drive Control Handle is in the NEUTRAL position (and machine speed is less than 0.5 mph/ 0.8 km/h).



Field/Road Button
(Located on the
Machine Display Home Page)



Main Tank Valve Status Indicator
(Located on the Machine Display
Home Page - Field Mode)

NOTE: The selected drive state will illuminate.

6. Position boom to desired position.
7. Press the Main Tank Valve Switch (located on the side console) in the UP (Open) position.



Main Tank Valve Switch
(Located on the side console)
-Typical View

NOTE: Main Tank Valve status (OPEN or CLOSED) is displayed on the Machine Display Home Page (Field Mode).

8. Press desired Rate Control Switch (located on the side console).
 - Press ENABLE to allow the rate controller to control application rate.
 - Press MAN (Manual) to control application rate from the section keypad.
 - Press ENABLE and MAN to enable manual rate control through the rate controller.

NOTE: When “MAN” is selected, press the Pump Speed/Rate Switches (located on the side console) to increase (+) or decrease (-) application rate. Current solution pump speed is displayed below the Solution Pump Indicator (located on the Machine Display Home Page - Field Mode).

NOTE: Increasing or decreasing pump speed will change the application rate through the rate controller.



Rate Control and
Pump Speed/Rate Switches
(Located on the side console)
-Typical View

9. Press the Solution Pump Switch (located on the side console) in the UP (On) position.

NOTICE

Do not allow the Solution Pump to run continuously while the Boom Solution Valve Switches are off. Failure to comply will generate overheating, causing severe pump damage and will void the warranty.



Solution Pump Switch
(Located on the side console)
-Typical View

10. Turn the Master Spray Switch (located on the Hydrostatic Drive Control Handle) ON.



Master Spray Switch
(Located on the Hydrostatic
Drive Control Handle)
-Typical View

NOTE: When the Master Spray Switch is ON, a Master Spray Indicator (located on the Machine Display Home Page - Field Mode) will illuminate.



Master Spray Indicator
(Located on the Machine Display
Home Page - Field Mode)

11. Press the individual Boom Solution Valve Switches (located on the side console) to the ON (non-illuminated) position.

NOTE: Each Boom Solution Valve Switch is equipped with an indicator light and will illuminate when the corresponding Boom Solution Valve is OFF.



Boom Solution Valve Switches
(Located on the side console)
-Typical View

12. Slowly move the Hydrostatic Drive Control Handle forward to obtain desired ground speed.
13. Frequently observe the pressure gauge. If the pressure drops to zero or spray pattern deteriorates, turn OFF the Master Spray, Solution Pump, and Main Tank Valve Switches until solution is refilled.

FILLING YOUR SOLUTION TANK

⚠ DANGER



NEVER ENTER SOLUTION TANK WITH WHOLE BODY. FAILURE TO COMPLY WILL RESULT IN SERIOUS INJURY OR DEATH.

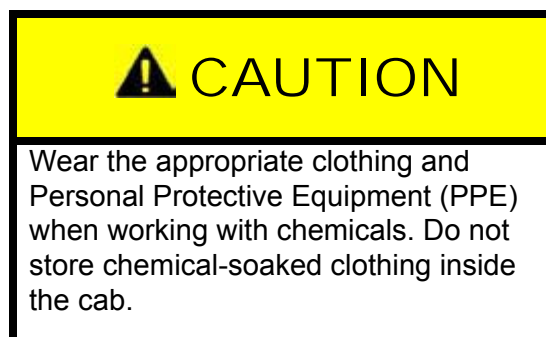

To Fill the Solution Tank

1. Release cam-lock levers and remove cap from top Solution Tank Fill Port (located on the left-hand side of machine).

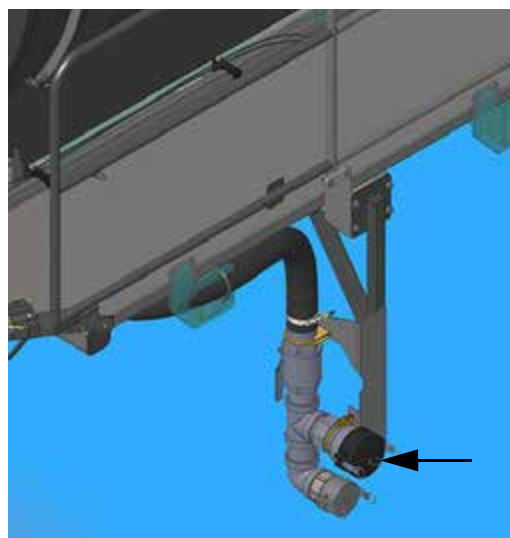

Solution Tank Fill Port
(Located on the left-hand side of machine)
-Typical View

2. Connect solution supply to fill port.
3. Rotate Solution Tank Valve (located on the back side of fill port assembly) in the OPEN (counter-clockwise) position and fill tank to desired level.

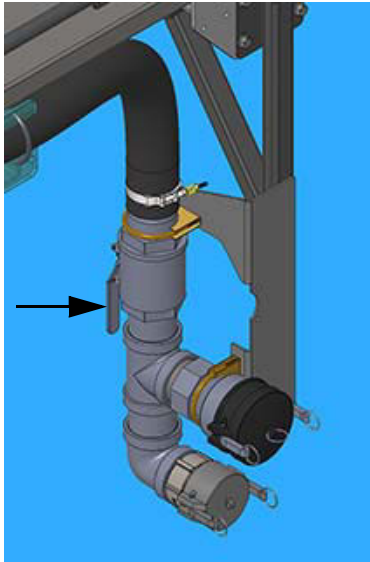

Solution Tank Valve
(Located on the back
side of fill port assembly)
-Typical View

4. **When finished filling the tank**, rotate the Solution Tank Valve in the CLOSED (clockwise) position.
5. Remove solution supply from fill port.
6. Reinstall fill port cap and re-lock the cam-lock levers.

DRAINING YOUR SOLUTION TANK

⚠ DANGER



NEVER ENTER SOLUTION
TANK WITH WHOLE BODY.
FAILURE TO COMPLY WILL RESULT
IN SERIOUS INJURY OR DEATH.

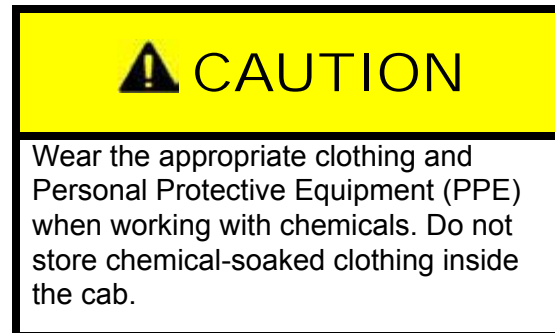

To Drain the Solution Tank

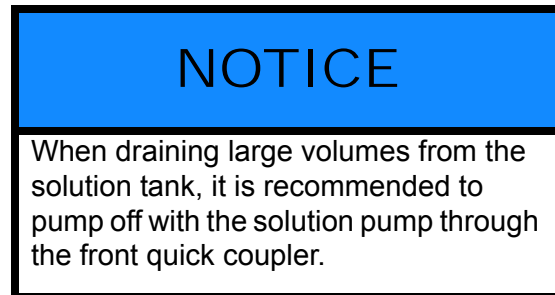

1. Release cam-lock levers and remove cap from bottom Solution Tank Drain Port (located on the left-hand side of machine).

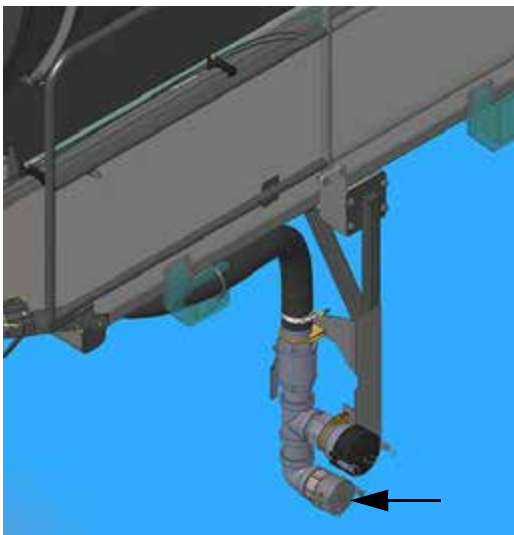

Solution Tank Drain Port
(Located on the left-hand side of machine)
-Typical View

2. Connect operator-supplied drain hose to the end of Solution Tank Drain Port.
3. Rotate Solution Tank Valve (located on the back side of drain port assembly) in the OPEN (counter-clockwise) position and allow solution to drain into an appropriate container for storage.

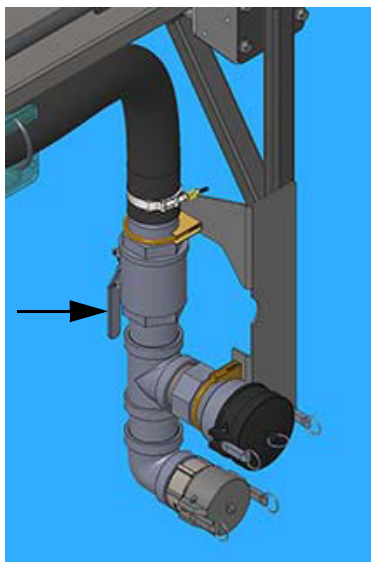

Solution Tank Valve
(Located on the back side
of drain port assembly)
-Typical View

NOTE: Always ensure that storage containers are clearly marked with type of chemical being stored.

4. **When finished draining the tank**, rotate the Solution Tank Valve in the CLOSED (clockwise) position.
5. Remove hose from drain port.
6. Reinstall fill port cap and re-lock the cam-lock levers.

APPLICATION

It is important to apply chemicals as recommended by the manufacturer. In order to do so, the spray system console must be properly calibrated.

NOTE: Refer to the spray system console manufacturer's operation manual for calibration instructions.

Determine the speed in which the machine will travel when applying chemicals. Remember that the performance of the nozzles (spray tips) and spray system are dependent on the performance of the operator. If the spray system is operated within set parameters of the nozzle type and spray system console, you will see greater success with your application. Operating the machine one or two miles per hour (1.6 to 3.2 km/h) faster or slower than intended can greatly change the pressure and droplet size.

Select nozzle spacing (distance between each nozzle on the spray boom) that is best suited for the intended spray application. For recommendation in determining nozzle spacing and height of the boom, visit www.teejet.com for further information.

There are various types and sizes of nozzles. Select and install the appropriate nozzle best suited for the intended spray application. The size of nozzles selected will be based on the speed in which the machine will travel, nozzle spacing, desired droplet size, and the number of gallons per acre (GPA)/liters per hectare (l/ha) that will be applied.

Nozzle Selection

There are several things to consider when selecting the correct nozzle type for the intended spray application. Whatever your personal preference is, ensure that the nozzle complies with the chemical manufacturer's standards for spray control and also any environmental standards for your region.

NOTE: Certain regions may have restrictions on drift control.

Once you have selected the type of nozzle, you must choose the size of the nozzle. There are three main things to consider when choosing a nozzle size:

1. Recommendation of GPA (l/ha).
2. The speed in which you intend to travel when applying chemical and nozzle spacing (distance between nozzles).
3. Spray tip size (refer to the following example on how to select a proper tip size).

The following Application Rate Chart provides tabulations based on spraying water. When spraying liquids other than

water, you will need to use a conversion factor to configure the appropriate application rates.

Example of how to choose the proper nozzle:

Joe is spraying 28% nitrogen. The chemical manufacturer recommends that the chemical be applied at 20 gallons per acre (GPA)/187 liters per hectare (l/ha). Joe knows that he can run his sprayer at 10 mph (16 km/h). He has 20-inch (50 cm) nozzle spacing on his booms. Joe has narrowed his tip search to flat spray tips.

Use the following conversion formula:

- **20 GPA (187 l/ha) (liquid other than water) x 1.13 (conversion factor) = 22.6 GPA (211.3 l/ha) (water).**

Joe determined that he needs an application rate of 22.6 GPA (211.3 l/ha) to select the correct nozzle to apply 28% nitrogen at 20 GPA (187 l/ha).

To determine which nozzle is better for his intended use, Joe needs to figure out the gallons per minute (GPM)/liters per minute (l/min) each nozzle needs to spray.

GPM =	$\frac{\text{GPA} \times \text{MPH} \times \text{Nozzle Spacing}}{5940 \text{ (Constant)}}$
--------------	---

l/min =	$\frac{\text{l/ha} \times \text{km/h} \times \text{Nozzle Spacing}}{60,000}$
----------------	--

Examples:

GPM =	$\frac{22.6 \times 10 \times 20}{5940}$	$= \frac{4520}{5940}$	$= \mathbf{0.76 \text{ GPM}} \text{ (per nozzle)}$
--------------	---	-----------------------	--

l/min =	$\frac{211.3 \times 16 \times 50}{60,000}$	$= \frac{169040}{60,000}$	$= \mathbf{2.82 \text{ l/min}} \text{ (per nozzle)}$
----------------	--	---------------------------	--

English to Metric Conversion

- Gallons per Acre (GPA) x 9.354 = Liters per Hectare (l/ha)
- Gallons per Minute (GPM) x 3.785 = Liters per Minute (l/min)

Metric to English Conversion

- Liters per Hectare (l/ha) x .1069 = Gallons per Acre (GPA)
- Liters per Minute (l/min) x .26 = Gallons per Minute (GPM)

NOTE: Always double check your application rates. The following tabulations are based on spraying water at 70° F./21° C.



Standard Application Rate Chart												
				Gallons per Acre (GPA) - 15" Nozzle Spacing								
Tip Cap.	Liquid Pressure (PSI)	Cap. 1 Nozzle (GPM)	Cap. 1 Nozzle (Oz./Min.)	4 mph	6 mph	8 mph	10 mph	12 mph	14 mph	16 mph	18 mph	20 mph
01	15	0.061	7.8	6.0	4.0	3.0	2.4	2.0	1.7	1.5	1.3	1.2
	20	0.071	9.1	7.0	4.7	3.5	2.8	2.3	2.0	1.8	1.6	1.4
	30	0.087	11	8.6	5.7	4.3	3.4	2.9	2.5	2.2	1.9	1.7
	40	0.10	13	9.9	6.6	5.0	4.0	3.3	2.8	2.5	2.2	2.0
	50	0.11	14	10.9	7.3	5.4	4.4	3.6	3.1	2.7	2.4	2.2
	60	0.12	15	11.9	7.9	5.9	4.8	4.0	3.4	3.0	2.6	2.4
	75	0.14	18	13.9	9.2	6.9	5.5	4.6	4.0	3.5	3.1	2.8
	90	0.15	19	14.9	9.9	7.4	5.9	5.0	4.2	3.7	3.3	3.0
015	15	0.092	12	9.1	6.1	4.6	3.6	3.0	2.6	2.3	2.0	1.8
	20	0.11	14	10.9	7.3	5.4	4.4	3.6	3.1	2.7	2.4	2.2
	30	0.13	17	12.9	8.6	6.4	5.1	4.3	3.7	3.2	2.9	2.6
	40	0.15	19	14.9	9.9	7.4	5.9	5.0	4.2	3.7	3.3	3.0
	50	0.17	22	16.8	11.2	8.4	6.7	5.6	4.8	4.2	3.7	3.4
	60	0.18	23	17.8	11.9	8.9	7.1	5.9	5.1	4.5	4.0	3.6
	75	0.21	27	21	13.9	10.4	8.3	6.9	5.9	5.2	4.6	4.2
	90	0.23	29	23	15.2	11.4	9.1	7.6	6.5	5.7	5.1	4.6
02	15	0.12	15	11.9	7.9	5.9	4.8	4.0	3.4	3.0	2.6	2.4
	20	0.14	18	13.9	9.2	6.9	5.5	4.6	4.0	3.5	3.1	2.8
	30	0.17	22	16.8	11.2	8.4	6.7	5.6	4.8	4.2	3.7	3.4
	40	0.20	26	19.8	13.2	9.9	7.9	6.6	5.7	5.0	4.4	4.0
	50	0.22	28	22	14.5	10.9	8.7	7.3	6.2	5.4	4.8	4.4
	60	0.24	31	24	15.8	11.9	9.5	7.9	6.8	5.9	5.3	4.8
	75	0.27	35	27	17.8	13.4	10.7	8.9	7.6	6.7	5.9	5.3
	90	0.30	38	30	19.8	14.9	11.9	9.9	8.5	7.4	6.6	5.9
025	15	0.15	19	14.9	9.9	7.4	5.9	5.0	4.2	3.7	3.3	3.0
	20	0.18	23	17.8	11.9	8.9	7.1	5.9	5.1	4.5	4.0	3.6
	30	0.22	28	22	14.5	10.9	8.7	7.3	6.2	5.4	4.8	4.4
	40	0.25	32	25	16.5	12.4	9.9	8.3	7.1	6.2	5.5	5.0
	50	0.28	36	28	18.5	13.9	11.1	9.2	7.9	6.9	6.2	5.5
	60	0.31	40	31	20	15.3	12.3	10.2	8.8	7.7	6.8	6.1
	75	0.34	44	34	22	16.8	13.5	11.2	9.6	8.4	7.5	6.7
	90	0.38	49	38	25	18.8	15.0	12.5	10.7	9.4	8.4	7.5

SECTION 7 –
 SPRAY SYSTEMS



03	15	0.18	23	17.8	11.9	8.9	7.1	5.9	5.1	4.5	4.0	3.6
	20	0.21	27	21	13.9	10.4	8.3	6.9	5.9	5.2	4.6	4.2
	30	0.26	33	26	17.2	12.9	10.3	8.6	7.4	6.4	5.7	5.1
	40	0.30	38	30	19.8	14.9	11.9	9.9	8.5	7.4	6.6	5.9
	50	0.34	44	34	22	16.8	13.5	11.2	9.6	8.4	7.5	6.7
	60	0.37	47	37	24	18.3	14.7	12.2	10.5	9.2	8.1	7.3
	75	0.41	52	41	27	20	16.2	13.5	11.6	10.1	9.0	8.1
	90	0.45	58	45	30	22	17.8	14.9	12.7	11.1	9.9	8.9
04	15	0.24	31	24	15.8	11.9	9.5	7.9	6.8	5.9	5.3	4.8
	20	0.28	36	28	18.5	13.9	11.1	9.2	7.9	6.9	6.2	5.5
	30	0.35	45	35	23	17.3	13.9	11.6	9.9	8.7	7.7	6.9
	40	0.40	51	40	26	19.8	15.8	13.2	11.3	9.9	8.8	7.9
	50	0.45	58	45	30	22	17.8	14.9	12.7	11.1	9.9	8.9
	60	0.49	63	49	32	24	19.4	16.2	13.9	12.1	10.8	9.7
	75	0.55	70	54	36	27	22	18.2	15.6	13.6	12.1	10.9
	90	0.60	77	59	40	30	24	19.8	17.0	14.9	13.2	11.9
05	15	0.31	40	31	20	15.3	12.3	10.2	8.8	7.7	6.8	6.1
	20	0.35	45	35	23	17.3	13.9	11.6	9.9	8.7	7.7	6.9
	30	0.43	55	43	28	21	17.0	14.2	12.2	10.6	9.5	8.5
	40	0.50	64	50	33	25	19.8	16.5	14.1	12.4	11.0	9.9
	50	0.56	72	55	37	28	22	18.5	15.8	13.9	12.3	11.1
	60	0.61	78	60	40	30	24	20	17.3	15.1	13.4	12.1
	75	0.68	87	67	45	34	27	22	19.2	16.8	15.0	13.5
	90	0.75	96	74	50	37	30	25	21	18.6	16.5	14.9
06	15	0.37	47	37	24	18.3	14.7	12.2	10.5	9.2	8.1	7.3
	20	0.42	54	42	28	21	16.6	13.9	11.9	10.4	9.2	8.3
	30	0.52	67	51	34	26	21	17.2	14.7	12.9	11.4	10.3
	40	0.60	77	59	40	30	24	19.8	17.0	14.9	13.2	11.9
	50	0.67	86	66	44	33	27	22	19.0	16.6	14.7	13.3
	60	0.73	93	72	48	36	29	24	21	18.1	16.1	14.5
	75	0.82	105	81	54	41	32	27	23	20	18.0	16.2
	90	0.90	115	89	59	45	36	30	25	22	19.8	17.8
08	15	0.49	63	49	32	24	19.4	16.2	13.9	12.1	10.8	9.7
	20	0.57	73	56	38	28	23	18.8	16.1	14.1	12.5	11.3
	30	0.69	88	68	46	34	27	23	19.5	17.1	15.2	13.7
	40	0.80	102	79	53	40	32	26	23	19.8	17.6	15.8
	50	0.89	114	88	59	44	35	29	25	22	19.6	17.6
	60	0.98	125	97	65	49	39	32	28	24	22	19.4
	75	1.10	141	109	73	54	44	36	31	27	24	22
	90	1.20	154	119	79	59	48	40	34	30	26	24
10	15	0.61	78	60	40	30	24	20	17.3	15.1	13.4	12.1
	20	0.71	91	70	47	35	28	23	20	17.6	15.6	14.1
	30	0.87	111	86	57	43	34	29	25	22	19.1	17.2
	40	1.00	128	99	66	50	40	33	28	25	22	19.8
	50	1.12	143	111	74	55	44	37	32	28	25	22
	60	1.22	156	121	81	60	48	40	35	30	27	24
	75	1.37	175	136	90	68	54	45	39	34	30	27
	90	1.50	192	149	99	74	59	50	42	37	33	30
15	15	0.92	118	91	61	46	36	30	26	23	20	18.2
	20	1.06	136	105	70	52	42	35	30	26	23	21
	30	1.30	166	129	86	64	51	43	37	32	29	26
	40	1.50	192	149	99	74	59	50	42	37	33	30
	50	1.68	215	166	111	83	67	55	48	42	37	33
	60	1.84	236	182	121	91	73	61	52	46	40	36
	75	2.05	262	203	135	101	81	68	58	51	45	41
	90	2.25	288	223	149	111	89	74	64	56	50	45



SECTION 7 -
SPRAY SYSTEMS

20	15	1.22	156	121	81	60	48	40	35	30	27	24
	20	1.41	180	140	93	70	56	47	40	35	31	28
	30	1.73	221	171	114	86	69	57	49	43	38	34
	40	2.00	256	198	132	99	79	66	57	50	44	40
	50	2.24	287	222	148	111	89	74	63	55	49	44
	60	2.45	314	243	162	121	97	81	69	61	54	49
	75	2.74	351	271	181	136	109	90	78	68	60	54
	90	3.00	384	297	198	149	119	99	85	74	66	59



Metric Application Rate Chart													
			Liters per Hectare (l/ha) - 40 cm Nozzle Spacing										
Tip Cap.	Liquid Press. (Bar)	Cap. 1 Nozzle (l/min)	4 km/h	6 km/h	8 km/h	10 km/h	12 km/h	14 km/h	16 km/h	18 km/h	20 km/h	25 km/h	30 km/h
01	1.0	0.23	86.3	57.5	43.1	34.5	28.8	24.6	21.6	19.2	17.3	13.8	11.5
	1.5	0.28	105	70.0	52.5	42.0	35.0	30.0	26.3	23.3	21.0	16.8	14.0
	2.0	0.32	120	80.0	60.0	48.0	40.0	34.3	30.0	26.7	24.0	19.2	16.0
	3.0	0.39	146	97.5	73.1	58.5	48.8	41.8	36.6	32.5	29.3	23.4	19.5
	4.0	0.45	169	113	84.4	67.5	56.3	48.2	42.2	37.5	33.8	27.0	22.5
	5.0	0.50	188	125	93.8	75.0	62.5	53.6	46.9	41.7	37.5	30.0	25.0
	6.0	0.55	206	138	103	82.5	68.8	58.9	51.6	45.8	41.3	33.0	27.5
	7.0	0.60	225	150	113	90.0	75.0	64.3	56.3	50.0	45.0	36.0	30.0
015	1.0	0.34	128	85	63.8	51.0	42.5	36.4	31.9	28.3	25.5	20.4	17.0
	1.5	0.42	158	105	78.8	63.0	52.5	45.0	39.4	35.0	31.5	25.2	21.0
	2.0	0.48	180	120	90.0	72.0	60.0	51.4	45.0	40.0	36.0	28.8	24.0
	3.0	0.59	221	148	111	88.5	73.8	63.2	55.3	49.2	44.3	35.4	29.5
	4.0	0.68	255	170	128	102	85.0	72.9	63.8	56.7	51.0	40.8	34.0
	5.0	0.76	285	190	143	114	95.0	81.4	71.3	63.3	57.0	45.6	38.0
	6.0	0.83	311	208	156	125	104	88.9	77.8	69.2	62.3	49.8	41.5
	7.0	0.90	338	225	169	135	113	96.4	84.4	75.0	67.5	54.0	45.0
02	1.0	0.46	173	115	86.3	69.0	57.5	49.3	43.1	38.3	34.5	27.6	23.0
	1.5	0.56	210	140	105	84.0	70.0	60.0	52.5	46.7	42.0	33.6	38.0
	2.0	0.65	244	163	122	97.5	81.3	69.6	60.9	54.2	48.8	39.0	32.5
	3.0	0.79	296	198	148	119	98.8	84.6	74.1	65.8	59.3	47.4	39.5
	4.0	0.91	341	228	171	137	114	97.5	85.3	75.8	68.3	54.6	45.5
	5.0	1.02	383	255	191	153	128	109	95.6	85.0	76.5	61.2	51.0
	6.0	1.12	420	280	210	168	140	120	105	93.3	84.0	67.2	56.0
	7.0	1.21	454	303	227	182	151	130	113	101	90.8	72.6	60.5
025	1.0	0.57	214	143	107	85.5	71.3	61.1	53.4	47.5	42.8	34.2	28.5
	1.5	0.70	263	175	131	105	87.5	75.0	65.6	58.3	52.5	42.0	35.0
	2.0	0.81	304	203	152	122	101	86.8	75.9	67.5	60.8	48.6	40.5
	3.0	0.99	371	248	186	149	124	106	92.8	82.5	74.3	59.4	49.5
	4.0	1.14	428	285	214	171	143	122	107	95.0	85.5	68.4	57.0
	5.0	1.28	480	320	240	192	160	137	120	107	96.0	76.8	64.0
	6.0	1.40	525	350	263	210	175	150	131	117	105	84.0	70.0
	7.0	1.51	566	378	283	227	189	162	142	126	113	90.6	75.5



SECTION 7 –
SPRAY SYSTEMS

03	1.0	0.68	255	170	128	102	85	72.9	63.8	56.7	51.0	40.8	34.0
	1.5	0.83	311	208	156	125	104	88.9	77.8	69.2	62.3	49.8	41.5
	2.0	0.96	360	240	180	144	120	103	90.0	80.0	72.0	57.6	48.0
	3.0	1.18	443	295	221	177	148	126	111	98.3	88.5	70.8	59.0
	4.0	1.36	510	340	255	204	170	146	128	113	102	81.6	68.0
	5.0	1.52	570	380	285	228	190	163	143	127	114	91.2	76.0
	6.0	1.67	626	418	313	251	209	179	157	139	125	100	83.5
	7.0	1.80	675	450	338	270	225	193	169	150	135	108	90.0
04	1.0	0.91	341	228	171	137	114	97.5	85.3	75.8	68.3	54.6	45.5
	1.5	1.12	420	280	210	168	140	120	105	93.3	84.0	67.2	56.0
	2.0	1.29	484	323	242	194	161	138	121	108	96.8	77.4	64.5
	3.0	1.58	593	395	296	237	198	169	148	132	119	94.8	79.0
	4.0	1.82	683	455	341	273	228	195	171	152	137	109	91.0
	5.0	2.04	765	510	383	306	255	219	191	170	153	122	102
	6.0	2.23	836	558	418	335	279	239	209	186	167	134	112
	7.0	2.41	904	603	452	362	301	258	226	201	181	145	121
05	1.0	1.14	428	285	214	171	143	122	107	95	85.5	68.4	57.0
	1.5	1.39	521	348	261	209	174	149	130	116	104	83.4	69.5
	2.0	1.61	604	403	302	242	201	173	151	134	121	96.6	80.5
	3.0	1.97	739	493	369	296	246	211	185	164	148	118	98.5
	4.0	2.27	851	568	426	341	284	243	213	189	170	136	114
	5.0	2.54	953	635	476	381	318	272	238	212	191	152	127
	6.0	2.79	1046	698	523	419	349	299	262	233	209	167	140
	7.0	3.01	1129	753	564	452	376	323	282	251	226	181	151
06	1.0	1.37	514	343	257	206	171	147	128	114	103	82.2	68.5
	1.5	1.68	630	420	315	252	210	180	158	140	126	101	84.0
	2.0	1.94	728	485	364	291	243	208	182	162	146	116	97.0
	3.0	2.37	889	593	444	356	296	254	222	198	178	142	119
	4.0	2.74	1028	685	514	411	343	294	257	228	206	164	137
	5.0	3.06	1148	765	574	459	383	328	287	255	230	184	153
	6.0	3.35	1256	838	628	503	419	359	314	279	251	201	168
	7.0	3.62	1358	905	679	543	453	388	339	302	272	217	181
08	1.0	1.82	683	455	341	273	228	195	171	152	137	109	91
	1.5	2.23	836	558	418	335	279	239	209	186	167	134	112
	2.0	2.58	968	645	484	387	323	276	242	215	194	155	129
	3.0	3.16	1185	790	593	474	395	339	296	263	237	190	158
	4.0	3.65	1369	913	684	548	456	391	342	304	274	219	183
	5.0	4.08	1530	1020	765	612	510	437	383	340	306	245	204
	6.0	4.47	1676	1118	838	671	559	479	419	373	335	268	224
	7.0	4.83	1811	1208	906	725	604	518	453	403	362	290	242
10	1.0	2.28	855	570	428	342	285	244	214	190	171	137	114
	1.5	2.79	1046	698	523	419	349	299	262	233	209	167	140
	2.0	3.23	1211	808	606	485	404	346	303	269	242	194	162
	3.0	3.95	1481	988	741	593	494	423	370	329	296	237	198
	4.0	4.56	1710	1140	855	684	570	489	428	380	342	274	228
	5.0	5.10	1913	1275	956	765	638	546	478	425	383	306	255
	6.0	5.59	2096	1398	1048	839	699	599	524	466	419	335	280
	7.0	6.03	2261	1508	1131	905	754	646	565	503	452	362	302
15	1.0	3.42	1283	855	641	513	428	366	321	285	257	205	171
	1.5	4.19	1571	1048	786	629	524	449	393	349	314	251	210
	2.0	4.83	1811	1208	906	725	604	518	453	403	362	290	242
	3.0	5.92	2220	1480	1110	888	740	634	555	493	444	355	296
	4.0	6.84	2565	1710	1283	1026	855	733	641	570	513	410	342
	5.0	7.64	2865	1910	1433	1146	955	819	716	637	573	458	382
	6.0	8.37	3139	2093	1569	1256	1046	897	785	698	628	502	419
	7.0	9.04	3390	2260	1695	1356	1130	969	848	753	678	542	452

20	1.0	4.56	1710	1140	855	684	570	489	428	380	342	274	228
	1.5	5.58	2093	1395	1046	837	698	598	523	465	419	335	279
	2.0	6.44	2415	1610	1208	966	805	690	604	537	483	386	322
	3.0	7.89	2959	1973	1479	1184	986	845	740	658	592	473	395
	4.0	9.11	3416	2278	1708	1367	1139	976	854	759	683	547	456
	5.0	10.19	3821	2548	1911	1529	1274	1092	955	849	764	611	510
	6.0	11.16	4185	2790	2093	1674	1395	1196	1046	930	837	670	558
	7.0	12.05	4519	3013	2259	1808	1506	1291	1130	1004	904	723	603

NOTE: The previous tabulations are based on 15" (40 cm) nozzle spacing. Visit www.teejet.com for tabulations if choosing spacing other than 15" (40 cm).

Verifying Calibration

WARNING

Do not add chemicals until calibration is complete. Contact with chemicals may cause serious injury or death.

To test your system, fill the solution tank with clean water. **Do not add chemicals until calibration is complete.**

1. Engage the parking brake.
2. Start the engine.
3. Throttle the engine to operating speed.
4. Turn the spray system console ON.
5. Ensure the drive state of the machine is in Field Mode on the Machine Display.
6. Press the Main Tank Valve Switch (located on the side console) in the UP (Open) position.
7. Press the Master Spray Switch (located on the Hydrostatic Drive Control Handle) in the ON position.
8. Press all Boom Solution Valve Switches (located on the side console) in the ON position.
9. Press the Manual ("MAN") Rate Control Switch (located on the side console).
10. Press the Pump Speed/Rate Switches (located on the side console) in the "+" position to increase flow.
11. Ensure there are no leaks and that all nozzles are spraying a desirable pattern.
12. Continue spraying in the stationary position for at least 10 minutes for proper warm-up of the sprayer and system.

Once the sprayer has had an adequate warm-up period, you will need to perform a "self test" to simulate speed (although the machine will remain stationary).

NOTE: The following "self-test" steps require measuring flow at given pressure.

- Collect one nozzle's spray for one (1) minute in an adequately sized and marked container.
- Verify that the collection equals or is close to the GPM (l/min) for the nozzle, pressure, speed, GPA (l/ha), and spacing that you are using.

Also to ensure accuracy, you will need to verify the flow meter. To do so:

- Collect one nozzle's spray for one (1) minute and multiply it by the number of nozzles on the boom. This should equal the amount measured through the flow meter.

Calculating Spray Width

The spray section widths will need to be entered into the spray system console during initial set-up. No matter what the length of the boom is or how many spray sections it has, the formula for calculating section widths are the same.

$$\text{Number of Nozzles} \times \text{Nozzle Spacing} = \text{Spray Section Width}$$

Example:

Section 2 of a 100-ft. boom with 15-inch (38 cm) nozzle spacing (10 spray nozzles).

$$10 \text{ Nozzles} \times 15 \text{ (Nozzle Spacing)} = 150'' \text{ (Section Width)}$$

$$10 \text{ Nozzles} \times 38 \text{ (Nozzle Spacing)} = 380 \text{ cm (Section Width)}$$



Further Information

Refer to the spray system console manufacturer's operation manual for complete operating and calibrating instructions, troubleshooting tips, and safety precautions.



SECTION 8 – MAINTENANCE AND STORAGE



Optimizing Our Customers Growth™

Hagle Manufacturing Company
P.O. Box 273
Clarion, IA 50525-0273
Toll Free: 800-247-4885
Fax: 515-532-3553
Email: haglehelp.com

LUBRICANT RECOMENDATIONS			
Component	General Specification	Recommended Lubricant	Recommended Service Interval
Engine Oil	API CJ-4, 15w40	Mobil Delvac™ 1300 Super 15w40	Oil Analysis Guidance or 500 hours
Engine Coolant	Fully formulated antifreeze/coolant ASTM D6210	Fleet Charge Coolant SCA Pre-Charged	2000 Hours or 2 Years
Hydraulic Oil	ISO 11158, Type HM/HV, VG 46	Mobilfluid™ 424 or product meeting General Specification	Oil Analysis Guidance or Change @1000 Hrs
Planetary/Hub Drives	Synthetic API GL-5/MT-1	Mobil Delvac Synthetic Gear Oil 75W-90	250 hrs or Yearly
Greased Points	NLGI 2, EP, ISO 220 No Solids or Molybdenum	Mobilgrease XHP™ 222 A non-moly grease	Daily

PLEASE CONSULT YOUR MANUAL FOR FURTHER DETAILS

Call 1.800.662.4525 for Mobil Product Specifications and Information or visit www.mobilindustrial.com

Hagle PH: 650460

NOTICE

Remove all chemical residue from the work area before performing service/maintenance.

NOTICE

Pump repair and replacement should be performed by qualified service personnel only. Replace with properly rated components. Refer to your parts manual for further information.

NOTICE

Refer to your parts manual when replacing hydraulic hoses to ensure you have the correct pressure rated hose.

SERVICE - FLUIDS

Hydraulic Oil

NOTICE

Ensure area is clean before changing hydraulic oil and filters to avoid contamination, such as dirt and debris. Failure to comply may result in severe hydraulic system damage.

NOTICE

Ensure engine is off before filling hydraulic oil reservoir.

Check the Hydraulic Oil Reservoir Sight Gauge level daily. Add just enough fluid to maintain oil level at mid-sight gauge.

NOTE: Hydraulic oil expands when heated. Always check oil level when it is cool.

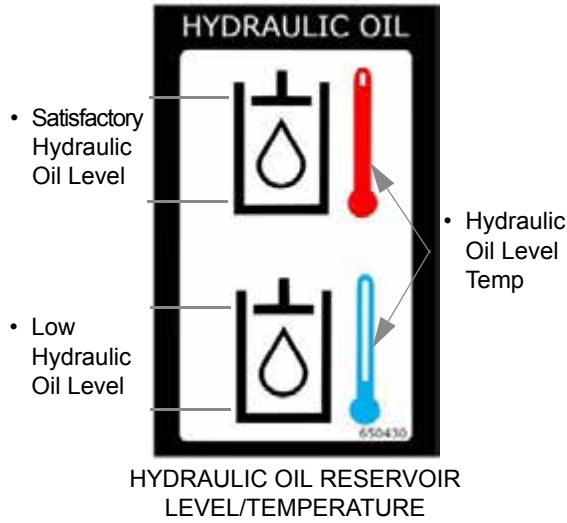

Hydraulic Oil Reservoir
(Located on left-hand side of
machine - open hood to access)
-Typical View

If hydraulic oil level is too low for safe operation, a warning message will appear on the Machine Display to alert you of low hydraulic oil level. Press OK to acknowledge, shut down the engine immediately, and refill reservoir to proper level to avoid damage to the hydraulic systems.



Low Hydraulic Oil Level Warning Message
(Located on the Machine Display)

NOTE: Replace hydraulic oil every 1,000 hours of operation.

Filling the Hydraulic Oil Reservoir

Capacity

- 37 gallons (140 L)

Type

- Premium performance anti-wear hydraulic oil containing high viscosity indexes, such as Mobil Univis™ HVI 26 is recommended for hydraulic systems that are subject to wide temperature variations.

Hydraulic oil can be added two different ways:

1. Through the hydraulic oil fill port (located on the side of the hydraulic return filter housing); or
2. Through the top of the hydraulic return filter housing. Remove bolts and cover to access.

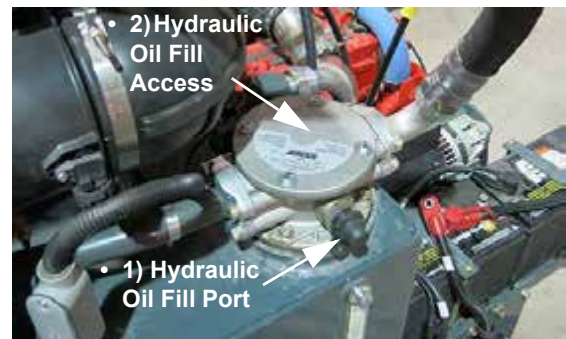

Hydraulic Oil Fill Options
-Typical View

Method 1 - Filling Through Hydraulic Oil Fill Port (Preferred Method)

NOTE: A hydraulic oil pump is required to fill through the hydraulic oil fill port, as gravity will not work and there is a small pressure to be overcome.

NOTE: Two (2) quick coupler fittings are provided in your tool kit to provide connection between the hydraulic oil fill port and the hydraulic oil pump that you are using.

- Remove the fill port rubber end cap.
- Attach hydraulic oil pump quick-connect fitting to the hydraulic oil fill port.
- Slowly squeeze pump handle and fill reservoir until oil level reaches mid-sight gauge.



Filling Tank Through Hydraulic Oil Fill Port
-Typical View

- When finished filling, release pump handle and disconnect quick-connect fitting from fill port.
- Reinstall fill port rubber end cap.

Method 2 - Filling Through Hydraulic Return Filter Housing

NOTE: Clean dirt/debris from return filter housing cover before removing.

- Using a 1/2" wrench, remove the four (4) bolts (located on top of the hydraulic return filter housing) and set aside.
- Remove cover and fill reservoir until oil level reaches mid-sight gauge.



Filling Tank Through Hydraulic
Return Filter Housing
-Typical View

- When finished filling, reinstall hydraulic return filter housing cover and bolts.

Wheel Hub Oil

Fairfield Wheel Hubs

Each wheel hub should maintain a proper oil level at all times. Less than that would limit lubrication and overfilling would cause overheating and machine damage.

Capacity

- 62 oz. (1.83 L)/each

Type

- Hagie Manufacturing Company recommends Mobil Delvac™ synthetic gear oil (75W-90) with EP features (complying with API GL-5/MT-1 specifications).

To check the oil level:

NOTE: Check wheel hub oil level every 100 hours of operation.

1. Position wheel hub so the bottom (oil drain) face plug is positioned at 6 o'clock (A).

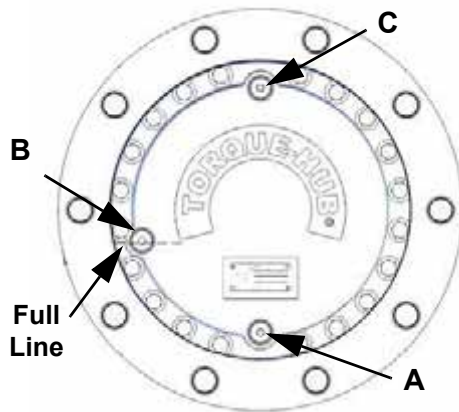

2. Remove 8 o'clock plug (B). If no oil comes out, proceed to Step 3.
3. If oil is needed, remove the top plug (C) and fill until oil begins to come out of the 8 o'clock plug (B).
4. Reinstall plugs.

To change the oil:

NOTE: Wheel hub oil should be changed after the first 50 hours of operation. After that, it should be changed every 250 hours of operation or yearly, whichever occurs first.

1. Position wheel hub so one of the face plugs is positioned at 6 o'clock and the other plug is positioned at either the 3 or 9 o'clock positions.
2. Remove plugs to drain oil.
3. Once all of the oil is drained, reinstall the bottom plug and remove the 3 or 9 o'clock plug.
4. Rotate wheel hub to the "fill" position so one of the plugs is positioned at 12 o'clock and the other plug is positioned at either the 3 or 6 o'clock positions.
5. Refill wheel hub with oil until satisfactory level is met.
6. Reinstall plugs.

General Maintenance

NOTICE

Failure to rotate the wheel hub and disperse oil may cause rusting and internal wheel hub damage.

If your machine is going to sit unused for an extended period of time, occasionally rotate the wheel hubs by driving the machine forward and backward - at least half of a tire rotation to adequately coat all internal wheel hub parts. This will prevent rusting if moisture inadvertently entered the wheel hub during an oil change.

Engine Oil

NOTICE

Never operate the engine with oil level below the "L" (low) mark or above the "H" (high) mark on the engine oil dipstick.

NOTICE

The engine must be level when checking oil level to ensure accuracy.

The Engine Oil Dipstick is located on the left-hand side of the engine (open hood to access). Wait at least five (5) minutes after shutting the engine off to check the oil level.

NOTE: Check the engine oil level daily.



Engine Oil Dipstick
(Located on the left-hand side
of engine - open hood to access)
-Typical View



Engine Oil Fill
(Located on top of engine)
-Typical View

Capacity

- Engine Oil Dipstick (low to high mark capacity) = 2 quarts (1.9 L)
- Engine Oil Pan Capacity (including filter and cooler) = 17.6 quarts (16.7 L)

Type

- Valvoline Premium Blue® Diesel Engine Oil - 15W-40 (recommended)

NOTE: Change the engine oil every 500 hours of operation or yearly, whichever occurs first.

NOTE: Use of any engine oil other than the recommended type (or less than API CJ4 specification) will require the oil to be changed every 250 hours of operation.



Remote Engine Oil Fill
(Located on rear left-hand side of
machine - open hood to access)
-Typical View

Diesel Exhaust Fluid (DEF) (Tier 4 Final Engines)



WARNING

Read the DEF manufacturer's label and comply with safety precautions to avoid injury or damage.

NOTICE

Never operate the engine with low DEF level. If DEF reaches a level that is too low for safe operation, the engine will begin to derate.

NOTICE

Ensure engine is off before filling the DEF tank.

Check the DEF Gauge (located on the cab A-post) daily. Add just enough DEF to keep the DEF tank full.

DEF Indicator Lamp Status

- When DEF level reaches 10% (indicated on the DEF Gauge), DEF Indicator Lamp will illuminate.
- When DEF level drops to 5%, DEF Indicator Lamp will flash.
- When DEF level drops to 2.5%, initial engine derate begins.
- When DEF level drops to 0%, secondary derate begins.

NOTE: Depending on the selected final inducement option, 30 minutes after the DEF Gauge reads 0%, the engine will either be locked at idle or will shut down. Refer to the engine manufacturer's service manual for information on how to recover from a low DEF level condition.



DEF Gauge
(Located on cab A-post)
-Typical View

Capacity

- DEF Tank Capacity = 10 Gallons (37 L)

Type

- Use only DEF which meet ISO 2224101 standards.

NOTE: Refill tank with DEF every other fuel fill to maintain adequate fluid level.

Filling the DEF Tank

Refer to “Engine Aftertreatment - Tier 4 Final” provided in the *Engine and Drive Systems Section* elsewhere in this manual for further information.

DEF Storage

DEF has a limited shelf life, both in the machine's DEF tank and in storage containers. The following conditions are ideal for maintaining DEF quality and shelf life during prolonged transportation and storage:

- Store DEF between 23° F (-5° C) and 77° F (25° C).
- Store DEF in sealed containers to avoid contamination.
- Avoid direct sunlight.

By following these conditions, DEF has a minimum expected shelf life of approximately 18 months.

NOTE: When storing DEF in higher temperatures for an extended period of time, the shelf life will be reduced by approximately 6 months for every 9° F (5° C) above the highest storage temperature as previously listed.

Long-term DEF storage in a machine (in excess of 6 months) is not recommended. If long-term storage is necessary, periodic testing of the DEF is recommended to ensure adequate concentration. Having the correct concentration of DEF is critical in engine and aftertreatment system performance.

NOTE: To help prevent DEF deterioration when stored in the DEF tank, locate and plug the tank venting to seal tank exposure against environmental elements.

Checking DEF Concentration

DEF concentration should be checked when the machine has been stored for an extended period of time or if it is suspected that water has been added to the DEF tank.

- Use a refractometer to check DEF concentration.

NOTE: Refer to the engine manufacturer's operation manual for further information on checking DEF concentration.

- If the DEF concentration is found to be inadequate (outside of recommended specification):
 1. Drain the DEF tank.
 2. Flush tank with distilled water.
 3. Refill tank with new DEF.
 4. Recheck DEF concentration.

Freezing

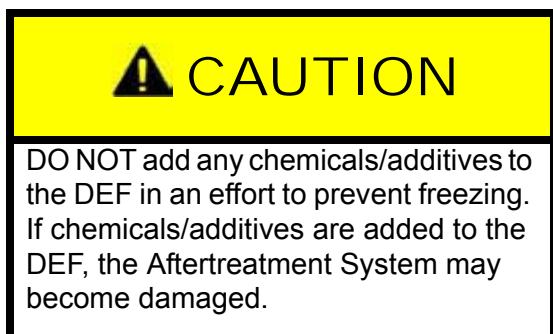

DEF will freeze around 12° F (-11° C). The DEF system on the machine is designed to accommodate this and does not require any operator intervention.

DEF Disposal

Check with local authority regulations on proper DEF disposal requirements.

Cooling System

The cooling system should be sufficiently charged with an adequate mixture of antifreeze and water, regardless of climate, to maintain broad operating temperature range. Follow the coolant manufacturer's recommendations for your climate.

NOTE: The cooling system has been factory-filled with an ethylene glycol-based antifreeze.

Capacity

- Cooling System Capacity = 14 gallons (53 L)

Checking Coolant Level/Concentration



Check coolant level daily. Ensure fluid level is visible within the sight gauge. Coolant level is low if fluid is not seen in the sight gauge.

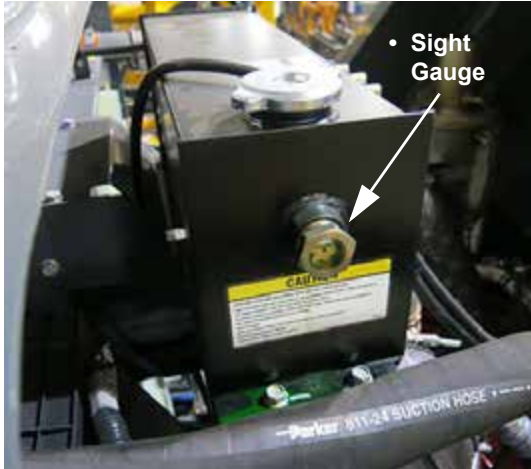

Radiator
(Located near the rear of
machine - open hood to access)
-Typical View

A 50/50 ethylene glycol and water mixture is a conservative mixture, which allows protection against both overheating and freezing.

NOTE: If a stronger antifreeze mixture is required, ensure not to exceed the engine manufacturer's guidelines for antifreeze-water mixing. Refer to "ASTM D 6210" or "ASTM D 7715" standards for further information.

The following Ethylene Glycol Table gives a few examples of ethylene glycol antifreeze/water mixture protection values.

Ethylene Glycol		
40%	-23° C	-10° F
50%	-37° C	-34° F
60%	-54° C	-65° F

Coolant concentration should be checked every 500 hours of operation or at the beginning of each spray season, whichever occurs first. A refractometer should be used to check concentration.

NOTE: "Floating Ball" type density testers are not accurate for use with a heavy duty diesel cooling system.

Changing Coolant



Coolant should be changed periodically to eliminate the buildup of harmful chemicals. Drain and replace the coolant every other spray season or 1,000 hours of operation, whichever occurs first. Refill with soft water only, as hard water contains minerals, which break down the anti-corrosion properties of the antifreeze.

Further Information

Refer to the engine manufacturer's operation manual for further information.

Engine Fuel



NOTE: Keep a fire extinguisher nearby when refueling.

DO NOT fill fuel tank completely. Fuel can expand and run over. Wipe up all spilled fuel and clean with detergent and water before starting the engine.

Capacity

- Fuel Tank Capacity = 170 gal. (643 L)

Type

- Ultra-Low Sulfur Diesel (ULSD) fuel required.

Filling the Fuel Tank

1. Shut the engine off.
2. Remove fuel fill cap and set aside.

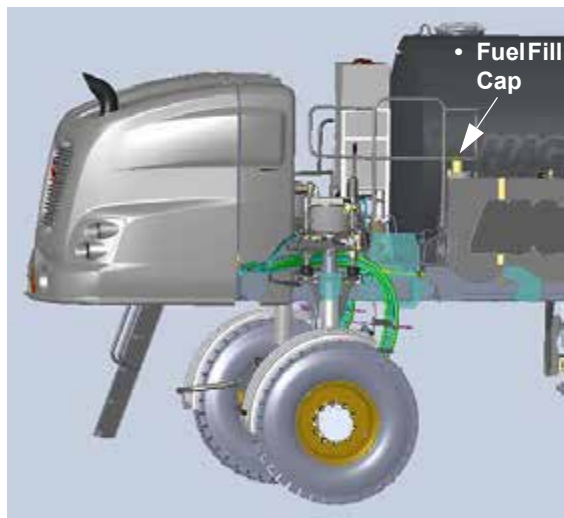

Engine Fuel Fill
(Located on top of fuel tank
on right-hand side of machine)
-Typical View

3. Fill tank to desired level.
4. Reinstall the fuel fill cap.

Air Conditioning

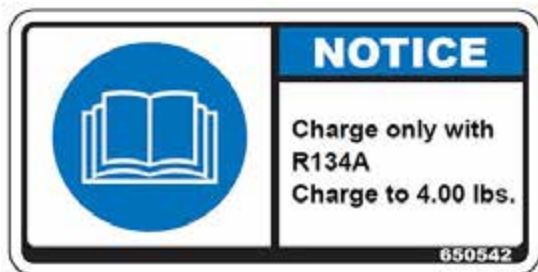

DO NOT MIX REFRIGERANTS

Recharging the AC System

The cab is equipped with an R134A Air Conditioning System. **Recharge system with R134A refrigerant only.**

NOTE: Confirm refrigerant before recharging the Air Conditioning System. If your system is mistakenly recharged with R12 refrigerant, machine damage (such as compressor seizure) may result. If you do not have the proper equipment, it is recommended that you allow an authorized service technician service your Air Conditioning System.



A/C Charge Ports
(Located above mainframe on
rear left-hand side of machine)
-Typical View

Windshield Washer Fluid

The Windshield Washer Fluid Reservoir is located behind the left-hand side of exterior cab. Check fluid level before each use and fill with non-freezing automotive windshield washer fluid, as required.



Windshield Washer Fluid Reservoir
(Located behind the
left-hand side of exterior cab)
-Typical View

Deluge Solution (De-Icer)

The Deluge Solution Reservoir is located along the rear platform behind the solution tank. Check fluid level before each use and fill with de-icer solution as required.

Capacity

- Deluge Solution Reservoir Capacity = 45 gal. (170 L)

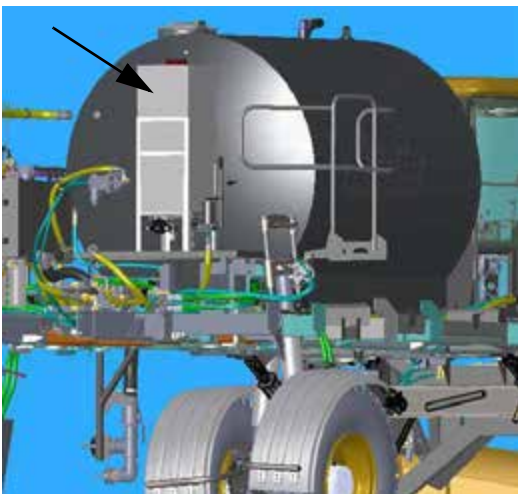

Deluge Solution Reservoir
(Located along rear
platform behind solution tank)
-Typical View

Filling the Deluge Solution Tank

Refer to “Deluge System” provided in the *Miscellaneous Section* elsewhere in this manual for further information.

SERVICE - FILTERS

Engine Air Intake

The Engine Air Intake Filter is located on the rear left-hand side of machine (remove panel on left-hand side of hood to access). A premium air intake filter removes contaminants from the intake air to optimize air quality and increase engine performance, and has nearly twice the capacity of a standard air filter. The Engine Air Intake is featured with a dual-type air cleaner, ensuring air entering the engine is as clean as possible.

An Engine Air Pre-Cleaner (located on the rear left-hand side of machine - open hood to access) pulls air and removes contaminants from entering the engine air intake.

- Engine Air Intake Filter
- Engine Air Pre-Cleaner



Engine Air Intake Filter and Pre-Cleaner
(Located on rear left-hand side of machine)
-Typical View



Engine Air Intake Filter Access Panel
(Located on left-hand side of hood)
-Typical View

NOTICE

Do not tap filter to remove dust. A crushed filter caused by tapping may result in engine damage. Remove and replace filter as recommended.

Removal

The Engine Air Intake Filter should only be removed if replacement is required.

- Unlock the security latches on the engine air intake filter access panel. Remove panel and set aside.
- Remove filter.

NOTE: Use care when removing the filter to ensure dust from the filter does not enter the air intake passage.

NOTE: The secondary filter does not need to be replaced if the primary filter is intact.

Replacement

Your machine is equipped with a Filter Minder® to notify you of filter element efficiency.

Cleaning

It is not recommended to clean the Engine Air Intake Filter element. However, a clean damp cloth should be used to wipe away dust and debris from the air cleaner housing.

Filter Minder

The Filter Minder (located near the engine pre-filter - open hood to access) is an air restriction monitoring system that progressively and constantly indicates how much air filter capacity remains to aid in achieving best preventative maintenance practices by ensuring air filter replacement only occurs when necessary.



Filter Minder
(Located near engine pre-filter
- open hood to access)
-Typical View

NOTE: An air filter service interval message will appear on the Machine Display notifying you that the engine air filter is restricted and that filter replacement is recommended.

Radiator Screen

NOTICE

Failure to keep cooling systems clean can cause overheating and damage to the engine and hydrostatic systems.

To maintain adequate airflow through the engine cooling system, the Radiator Screen (located ahead of rear hood) must be inspected daily and cleaned as necessary.

To Remove the Radiator Screen

- Remove the two (2) Radiator Screen Spring Clips (located on the top left and right-hand side of screen) and set aside.



Radiator Screen Spring Clips (2)
(Located on the top left and
right-hand side of screen)
-Typical View

- Extend the top of Radiator Screen outward and lift the bottom of screen out of lower pin cradles.

To Reinstall the Radiator Screen

- At a slight angle, install the lower screen pins into the pin cradles (located near the bottom of the cooling pack), as shown in the following illustration.

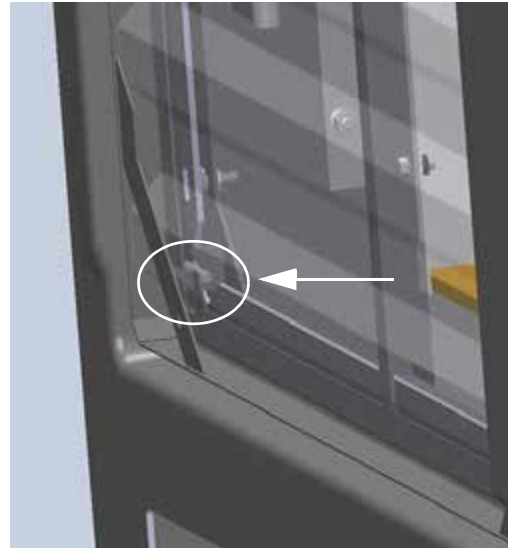

-Typical View

- Rotate screen inward until the mounting pins protrude through the screen.
- Reinstall the two (2) Radiator Screen Spring Clips.

Cleaning the Radiator Screen

Use compressed air to dislodge large debris and dirt. Water from a pressurized hose may also be used or if necessary, the screen may be soaked with soapy water and scrubbed gently with a brush.

NOTE: When cleaning the cooling fins of the radiator, oil cleaner, or A/C condenser with compressed air or water, be careful not to damage the cooling fins, which may impair cooling capabilities.

Engine Oil Filter

The Engine Oil Filter (located along left-hand side of machine - open hood to access) should be replaced every 500 hours of operation or whenever the oil is changed, whichever occurs first.

Refer to the engine manufacturer's operation manual for further information.

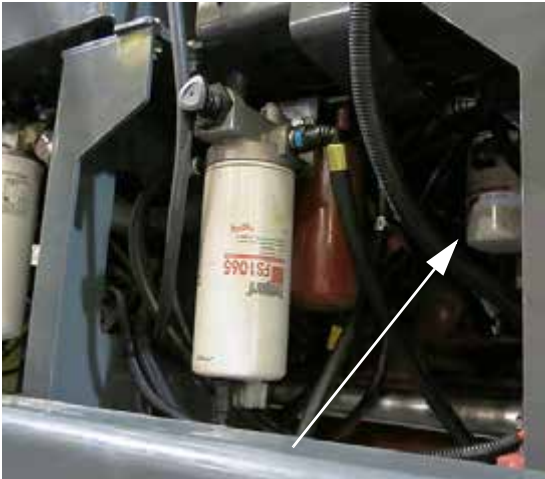

Engine Oil Filter
(Located along left-hand side of
machine - open hood to access)
-Typical View

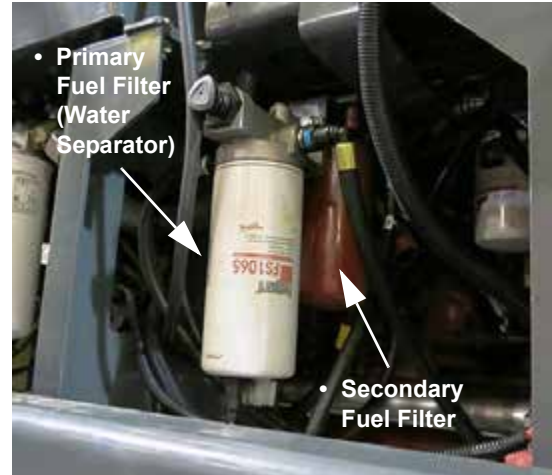

Primary and Secondary Fuel Filters
(Located along left-hand side of
machine - open hood to access)
-Typical View

Fuel Filters

Primary Fuel Filter (Water Separator)

The Primary Fuel Filter (located along left-hand side of machine - open hood to access) should be drained of water and other deposits daily. Replace the filter every 500 hours of operation or yearly, whichever occurs first.

Secondary Fuel Filter

The Secondary Fuel Filter (located along left-hand side of machine - open hood to access) should be replaced every 500 hours of operation or yearly, whichever occurs first.

Refer to the engine manufacturer's operation manual for further information.

NOTE: Cummins® recommends specific high performance fuel filters, which will aid in achieving optimum engine performance and efficiency. Refer to the engine manufacturer's operation manual for further information and specifications.

Diesel Exhaust Fluid (DEF) Supply Module Filter (Tier 4 Final Engines)

The DEF Supply Module Filter (located near the bottom of the DEF Supply Module) should be replaced every 4,500 hours of operation or every three (3) years, whichever occurs first.

Refer to the engine manufacturer's operation manual for further information.

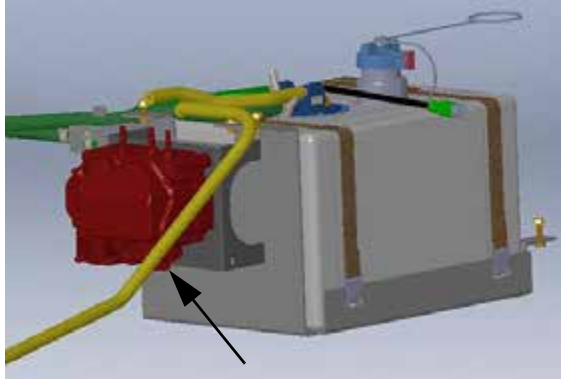

DEF Supply Module Filter
(Located near the bottom
of the DEF Supply Module)
-Typical View

Hydraulic Filters

(Refer to your Parts Manual for specific location and replacement part numbers)

Remove and replace hydraulic filters every 500 hours of operation or yearly, whichever occurs first.

- Return Filter
- Pressure Filter
- Charge Pump Filter
- Case Drain Filter
- Breather Cap

Replacing Hydraulic Filters

Return Filter

NOTE: Replace Return Filter when the filter indicator indicates that replacement is needed, becomes tripped, or after 500 hours of operation, whichever occurs first.

1. Remove the four (4) bolts on top of the Return Filter Housing (located on top of the hydraulic oil reservoir) and set aside.



Return Filter Housing
(Located on top of hydraulic oil reservoir)
-Typical View

2. Remove Return Filter Housing cover and set aside.
3. Remove and discard used Return Filter.



Return Filter
(Located inside filter housing)
-Typical View

4. Install new Return Filter.
5. Reinstall filter housing cover and bolts.

Pressure Filter

1. Unlatch and lower metal shield (located beneath front end of machine).
2. Using a 15/16" wrench on the Pressure Filter Housing end bolt, turn "counter-clockwise" and remove filter housing.



Pressure Filter Housing
(Located beneath right-hand side of
machine - lower metal shield to access)
-Typical View

3. Remove and discard used Pressure Filter.
4. Install new Pressure Filter.
5. Reinstall Pressure Filter Housing and metal shield.

Charge Pump Filter

1. Ensure the engine is shut OFF.
2. Hold the Charge Pump Filter (located beneath the drive pump) in place and remove filter from housing using a 24mm wrench.



Charge Pump Filter
(Located beneath drive pump)
-Typical View

3. Remove and discard used Charge Pump Filter.

NOTE: Inspect the plug and seal surfaces in the filter bracket. Replace any damaged components.

4. Lubricate the seal and o-ring with hydraulic fluid.
5. Insert plug into filter bracket.
6. Using a 24mm wrench to hold the plug in place, install new Charge Pump Filter.

NOTE: Hand-tighten filter until it makes contact with the o-ring, then tighten half a turn further.

7. Turn the engine ON.
8. Cycle the pump through normal machine operation and check for leaks.

Case Drain Filter

1. Using a 2-inch wrench, loosen Case Drain Hose (located near top of hydraulic reservoir) to prevent siphoning when changing the Case Drain Filter.



Case Drain Hose
(Located near top of hydraulic reservoir)
-Typical View

2. Turn Case Drain Filter (located on left-hand side of machine) to the left to loosen.



Case Drain Filter
(Located on left-hand side of machine)
-Typical View

3. Remove and discard used Case Drain Filter.
4. Install new Case Drain Filter, turning right to tighten.
5. Re-tighten Case Drain Hose.

Breather Cap

1. Loosen Breather Cap (located on top of hydraulic oil reservoir) by turning “counter-clockwise”.



Breather Cap
(Located on top of hydraulic oil reservoir)
-Typical View

2. Remove and discard used Breather Cap.
3. Install new Breather Cap and turn “clockwise” to tighten.

Strainers

(Refer to your Parts Manual for specific location and replacement part numbers)

Solution Line Strainer

⚠ CAUTION

Ensure the Main Tank Valve Switch is in the CLOSED position before servicing the Solution Line Strainer. Failure to comply may result in chemical contact.

Maintain consistent application rates by inspecting the Solution Line Strainer (located beneath the center right-hand side of machine) daily for blockage. Clean the strainer screen as needed and ensure the gasket is in place before reinstalling the screen.

NOTE: Wear appropriate clothing while removing and cleaning the strainer screen.



Solution Line Strainer
(Located beneath the center right-hand side of machine)
-Typical View

Section Strainers

- If Equipped (80-Mesh Strainer Screens)

Section Strainers are located throughout each boom section and filter impurities to aid in the avoidance of spray nozzle buildup. Remove bottom section of each strainer and clean strainer screen as needed.

NOTE: Wear appropriate PPE while removing and cleaning the strainer screen.

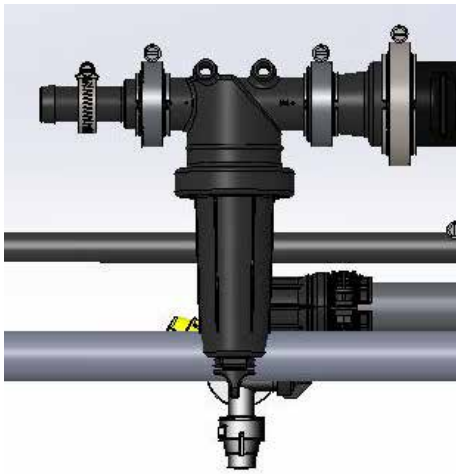

Section Strainer
(Located throughout each boom section)
-Typical View

Deluge Solution Strainer

An in-line strainer is located at the bottom of the deluge solution reservoir. Remove strainer and clean strainer screen periodically to avoid dirt and debris from entering the system and to ensure adequate flow.

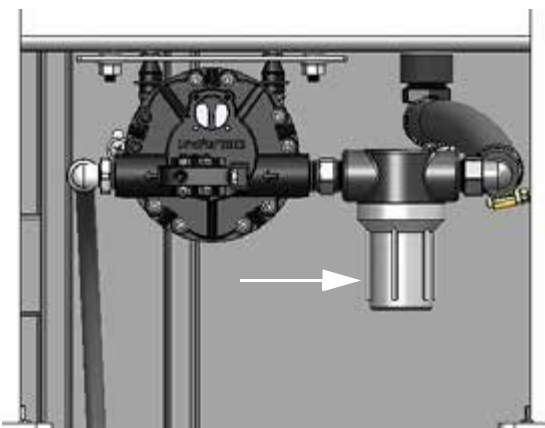

Deluge Solution Strainer
(Located near bottom
of deluge solution reservoir)
-Typical View

Hand Wash Strainer

A strainer is located near the bottom of the hand wash tank. Remove strainer and clean screen periodically to avoid dirt and debris from entering the system.

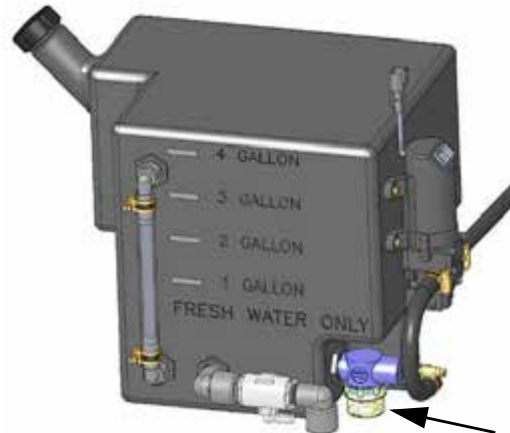

Hand Wash Strainer
(Located near bottom of hand wash tank)
-Typical View

Cab Filters

RESPA® Cab Filter

NOTE: Replace the RESPA Cab Filter every 1,000 of operation or when cab pressure drops below the minimum pressure threshold (when cab is sealed), whichever occurs first.

Replacing the RESPA Cab Filter:

⚠ CAUTION

Do not clean or reuse filters. Failure to comply may create health hazards.

NOTICE

Replace filter in a clean and covered area to reduce operator and HVAC exposure to harmful particulates.

NOTICE

Ensure engine is turned OFF before servicing the RESPA Cab Filtration System.

NOTICE

When cleaning your machine, care should be taken to prevent high-pressure water or air from entering the RESPA Filtration System ejection slots. When replacing the slotted filter, do not point ejection slots at a solid surface in close proximity to the slots.

NOTE: Wear Personal Protective Equipment (PPE) when servicing the RESPA Cab Filtration System.

1. Turn engine OFF.
2. Inspect RESPA Cab Filtration System for damage.
3. Release the four (4) Filter Latches (located on the exterior filter housing).

NOTE: Note orientation of the ejection ports.



Filter Latches
-Typical View

4. Remove filter.

NOTE: When removing filter, place thumbs on exterior filter housing hardware for additional leverage.



Filter Removal
-Typical View

5. Place used filter in a sealed plastic bag and dispose.

NOTE: Dispose of filter according to local regulations.

6. Wipe off any loose debris around the filter housing using a clean cloth.

NOTE: DO NOT use compressed air to clean the filter housing.

7. Before installing the new filter, inspect the RESPA Cab Filtration System and replacement filter for proper operation.
8. Turn RESPA Filtration System ON, staying clear of the open end of the filter housing.
9. Ensure adequate airflow is blowing out of the empty filter housing.
10. Turn RESPA Filtration System OFF.
11. Install new filter.

NOTE: Ensure new filter ejection port orientation is correct and the filter end cap is properly seated on the filter housing (with the gills pointing downward to avoid water from entering in).

12. Re-latch the four (4) Filter Latches.
Refer to your Parts Manual for replacement part number.

Charcoal Filter

Remove and replace the Charcoal Filter at the first sign of chemical odor entering the cab area, or every 500 hours of operation at a minimum. Refer to your Parts Manual for replacement part number.

Accessing the Charcoal Filter

1. Loosen the top metal Flange Clamp (located near the top of the RESPA filtration unit).



Flange Clamp - Top
(Located near the top of the RESPA filtration unit)
-Typical View

2. Separate the RESPA filter housing from the vent tube.
3. Remove the four (4) Mounting Bolts (two located on each side of access panel on the right-hand side of cab) and set aside.



Mounting Bolts (4)
(Two located on each side of access panel on the right-hand side of cab)
-Typical View

4. Carefully lower access panel/filter assembly to the ground.

5. With the access panel removed, loosen and remove the Security Screw (located along the inside of filter compartment) and set aside.



Security Screw
(Located along the inside
of filter compartment)
-Typical View

6. Remove the Filter Bracket (located along the right-hand side of charcoal filter) and set aside.

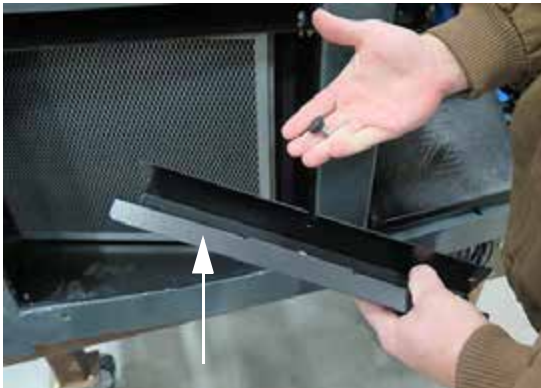

Filter Bracket
(Located along the right-hand
side of charcoal filter)
-Typical View

7. Remove Charcoal Filter.



Charcoal Filter
-Typical View

8. Replace Charcoal Filter and reverse steps to reinstall.

Recirculation Filter

A Recirculation Filter is located along the right-hand side of compartment (accessible after the Charcoal Filter has been removed). Remove the Recirculation Filter and clean with soap and warm water (wring out gently) anytime that the Charcoal Filter is replaced.

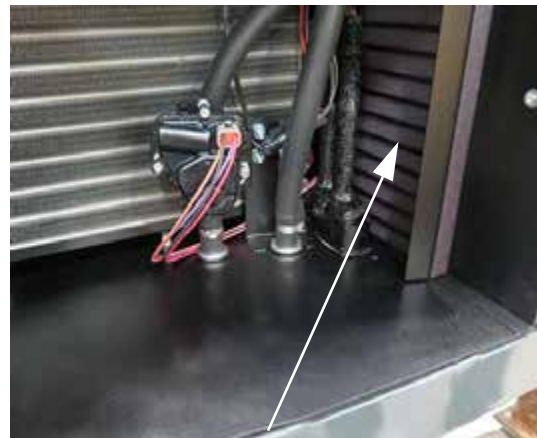

Recirculation Filter
(Located along the right-hand
side of compartment)
-Typical View

SERVICE - LUBRICATION

NOTICE

Failure to properly lubricate pivot and friction points may result in unnecessary wear and damage.

NOTICE

Mobilgrease XHP™ 222 (complying with NLGI 2, EP, ISO 220 specifications) recommended.

Legs and Steering

Tie Rod Ball (front legs)

- Lubricate every 25 hours of operation, or as needed.



Tie Rod Ball Grease Zerk (2)
(Located on the front legs)
-Typical View

All-Wheel Steer (AWS) ^

- If Equipped

If your machine is equipped with AWS, the steering cylinders on the rear legs also have grease zerks in the tie rod ends that require lubrication.

Tower Bearing (front and rear legs)

- Lubricate daily, or as needed.

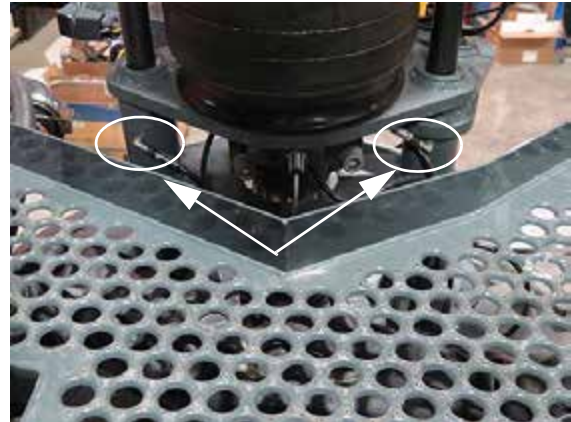

Tower Bearing Grease Zerks (8)
(Located on the front and rear legs)
-Typical View

Collar (air bag mounting plate)

- Lubricate every 50 hours of operation, or as needed.



Collar Grease Zerk (4)
(Located beneath each
air bag mounting plate)
-Typical View

Leg Tubes (front and rear legs)

NOTE: Initial greasing should fill the grease space until grease escapes the pressure relief valve (between 40-80 psi/2.8-5.5 bar).

- Lubricate the legs weekly. When grease escapes the pressure relief valve, the proper grease level has been reached.

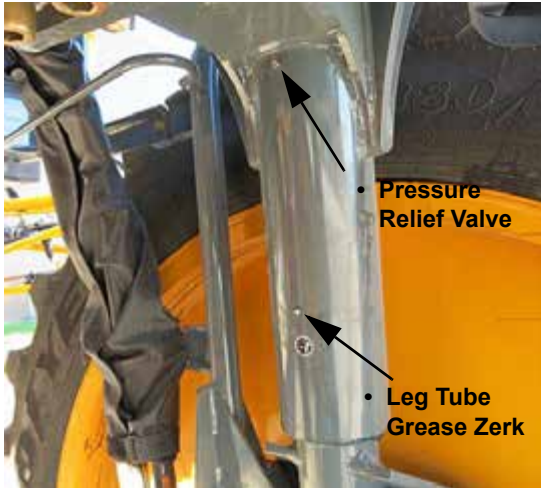

Leg Tube Grease Zerk and
Pressure Relief Valve
(Located on front and rear legs)
-Typical View



Transom Pivot Tube
-Typical View

Ladder Pivot Tube

Lubricate the grease zerk (located on the back side of the Ladder Pivot Tube) every 50 hours of operation, or as required.



Ladder Pivot Tube
-Typical View

Boom Fold

Lubricate the Boom Fold (where the main boom section connects to the boom extension) daily, or as needed.



Boom Fold
-Typical View

90/100' Booms

Transom Pivot Tubes

Lubricate the grease zerk on the Transom Pivot Tube - one on each side (that attaches the boom to the transom) every 50 hours of operation, or as needed.

Boom Breakaway

Lubricate the grease zerk on the Boom Breakaway daily, or as needed.



Boom Breakaway
-Typical View

Boom Breakaway Cylinder Rod End

NOTICE

Failure to lubricate the boom breakaway cylinder rod end grease zerks will result in damage to the breakaway cylinder and mounting if contact is made with an object.

Lubricate the grease zerk on the Boom Breakaway Cylinder Rod Ends daily, or as needed.



Boom Breakaway Cylinder Rod End
-Typical View

Plow

Various grease zerks are located throughout the Plow that require lubrication. Refer to the Plow manufacturer's operation manual for further information.

NOTE: Inspect the Plow blade for wear periodically each season and replace as necessary.

SERVICE - ENGINE DRIVE BELT

Removal

- Insert a 1/2" square ratchet drive into the belt tensioner. See following illustration.

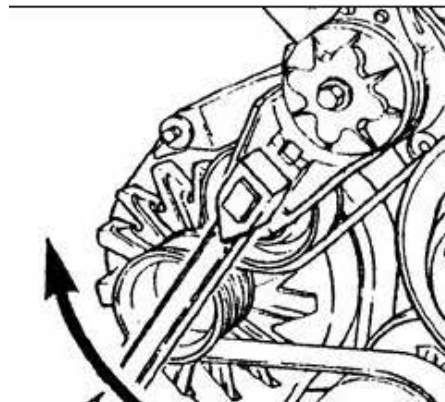

-Typical View

- Lift UP and remove Engine Drive Belt.

Inspection

- Visually inspect the Engine Drive Belt daily.
- Check the belt for intersecting cracks. See following illustration.

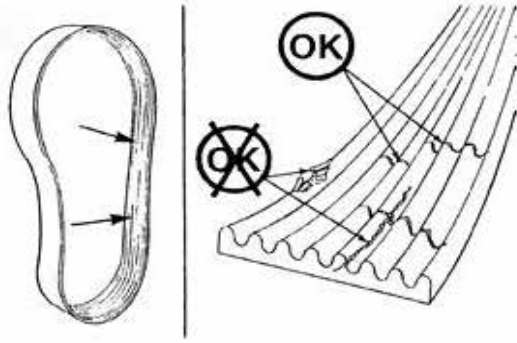

-Typical View

NOTE: Transverse cracks (across the belt width) are acceptable. Longitudinal cracks (direction of the belt length) that intersect with transverse cracks are not acceptable.

- Replace the Engine Drive Belt if it is frayed or has material missing.



To install wheel/tire assembly onto the wheel hub:

1. Ensure threads are thoroughly cleaned of rust and dirt.

NOTE: Threads should be dry (no lubricant).

2. Align the wheel bolt holes with the wheel hub studs.
3. Mount wheel on the hub.
4. Start all of the lug nuts and tighten until snug.
5. Following the torque sequence (as shown the following illustration), turn each lug nut to a torque value of 120 dry ft.-lbs.

NOTE: Use slow, even pressure on the torque wrench. Quick or jerky movements can cause inaccurate values.

SERVICE - BOLT TORQUE

NOTICE

Check lug nut torque immediately after receiving the machine and every 50 hours of operation thereafter.

Wheel Bolts

NOTE: If you do not have the proper equipment to mount a tire, contact a local qualified tire service center.

The tire should be mounted on the rim (as shown in the following illustration) for optimal traction and tread cleaning action.

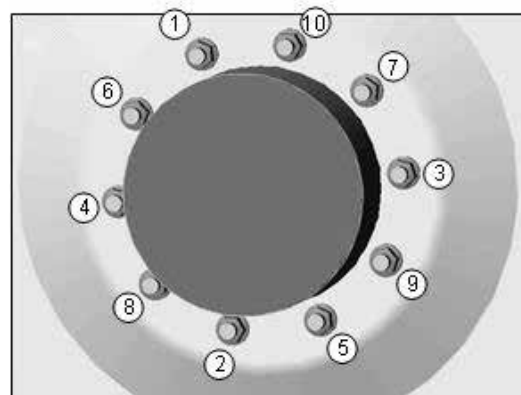

Torque Sequence

6. Repeat the same sequence to 150 dry ft.-lbs. and again to 400-500 dry ft.-lbs.

NOTE: If the wheel turns during lug nut torquing, lower machine to the ground - just enough for the tire to touch and prevent rotation. Or, more preferably, place a suitable wedge between the tire and the ground. Lower the machine and resume operation. Recheck torque after 30 minutes of operation.

- When torquing is complete, lubricate exposed threads with anti-seize compound.

NOTE: All four wheel hubs should measure the same distance.

- Mark this distance on the inner edge of the wheel rim (front and back of each rim - 8 marks total).

NOTE: All measurements will be taken from these markings.

- Visually align the tires from front to rear.

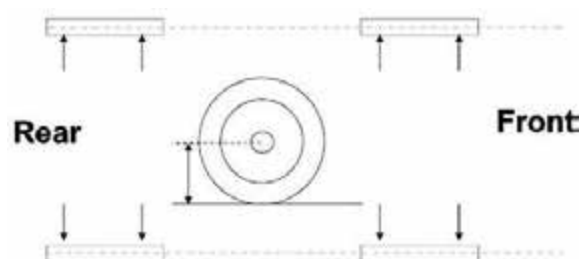

SERVICE - TOE-IN

Step 1 - Phase Steering Cylinders

The steering cylinders must be phased before any mechanical adjustments can be made (cylinder stroke = 8.8"/22.4 cm). When the cylinders are re-phased, each cylinder should reach mid-stroke (4.4"/11.2 cm). Once both cylinders are at 4.4"/11.2 cm, Toe-In can be set.

To Phase the Steering Cylinders

- Start the machine.
- Turn steering wheel to the right or left.
- When the wheels stop turning, continue to turn the steering wheel 3 to 4 full revolutions (this will put the cylinders back in phase with each other).

Step 2 - Set Toe-In

Front Wheels

- .25" (.6 cm) Toe-In per side/0.5" (1.3 cm) total Toe-In

Rear Wheels

- 0" (0 cm) Toe-In/Out

To Set Toe-In

- Deflate the air bags.

NOTE: Refer to "Air Suspension Exhaust" provided in the Miscellaneous Section elsewhere in this manual for further information.

- Measure the distance from the ground to center of wheel hub.

Front Wheels

- Measure the width between the front wheels (front W1, rear W2) at the wheel hub center line and record measurements.
- Adjust the wheels until the front and rear measurements are equal ($W1=W2$).
- Measure diagonally (D1 and D2) and record the measurements.
- Adjust the wheels until the measurements are equal.

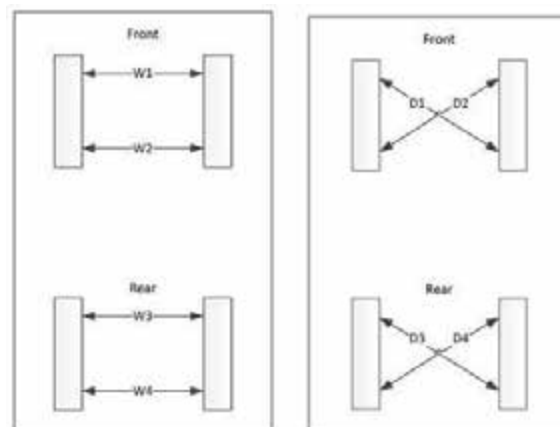

- Continue to cycle between Steps 5-6 and 7-8 until the width measurements match and the diagonal measurements match. Then and only then are the wheels parallel to each other and the frame.

NOTE: To achieve this, both conditions must be met.

NOTE: The front steering cylinders must both be centered before proceeding!

- Set both cylinders to center by measuring 7.64" (19.4 cm) (as shown in the following photo).

The position sensors should both read 4.4" (11.2 cm) when the cylinders are centered and in phase.

This is not required for All-Wheel Steer (AWS) machines, as the cylinder position sensors can be used to center the cylinders.

- The cylinder sensors must be calibrated for this position to be accurate.
- If the cylinders do not center at this measurement, they are not in phase. To re-phase the cylinders, turn the steering wheel so that one cylinder is fully retracted and the other is fully extended. Turn the steering wheel at least one full turn past this point. Re-center the cylinders. If the measurements still do not match, repeat the cylinder air bleed procedure.



- With the cylinders centered, adjust the tie-rods (located on the cylinder rods) until they line up with the bolt-down hole (located on the lower air bag plate).
- Turn the tie-rod one more full turn to achieve desired amount of toe-in.
 - When the rod ends are turned the final turn (to establish the desired amount of toe-in), the rod ends turn in opposite directions to get each wheel in toe.
 - If the amount of threads showing on the left and right rod ends differ by more than four (4) threads, repeat previous

Steps 1-12. If the difference remains, there may be a tolerance issue in the leg assembly.

- Pry wheel in to allow rod end securing bolt to be inserted.
- Insert the bolt and secure main bolt and cylinder jam nut to the proper torque specification.

Rear Wheels

NOTE: Rear wheels should be set to 0.0" (0.0 cm) toe in/out.

- Repeat previous Steps 1-9.
- (Non-AWS Machines)** - Set tie rod assembly to match up with the bolt-down hole (located on the lower air bag plate). Insert bolt and secure to the proper torque specification.
- (AWS Machines)** - Repeat Step 10, centering the rear cylinders at 4.4" (11.2 cm). Insert bolt and secure main bolt and cylinder jam nut to the proper torque specification.

NOTE: The cylinder sensors must be calibrated for this position to be accurate.

- The machine should be driven and toe (front and rear) rechecked.
- Front steering cylinders must be in phase when toe setting is checked.
- Failure to hold toe setting could indicate the presence of air in the cylinders.
- Repeat the cylinder bleeding procedure, if necessary.

Further Information

Contact your local John Deere dealer if additional assistance is needed.

SERVICE - MISCELLANEOUS

Air Bags

The Air Bags (one located on each leg) provide a smooth, consistent ride quality. A ride control valve increases/decreases compressed air into the air bags to maintain ride height position as load or wheel position changes with ground level for each leg independently.

*NOTE: The front air bags are larger capacity to accommodate heavier loads for various front end attachments, yet maintain a smooth ride.**



Air Bag
(Located on each leg)
-Typical View
** Front Air Bag Shown*

The system includes an Air Dryer (located beneath the right-hand side of machine) that dries air coming from the air compressor before sending it to a collection tank.



Air Dryer
(Located beneath the
right-hand side of machine)
-Typical View

From the collection tank, air is sent to the Air Bags as needed to maintain a level pressure. Control valves open and close to allow air in.

- Inspect the Air Dryer cartridge every 50 hours of operation to ensure that it is purging with compressor load. Change the cartridge every 1,000 hours of operation, or as needed.
- Inspect Air Bags daily for leaks and/or cracking. If an Air Bag is low, check the bag for any punctures or leaks.

Contact your local John Deere dealer if assistance is needed.

Air Tank



The Air Tank (located beneath platform on the left-hand side of machine) provides a volume of compressed air to give faster response for changes in air volume to the air bags.

- Drain the Air Tank daily by slowly releasing the Tank Drain Valve.

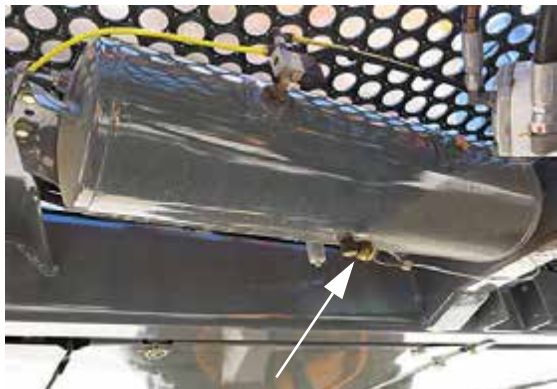

Tank Drain Valve
(Located beneath platform
on left-hand side of machine)
* **Pull DOWN** to open
-Typical View

NOTE: Check for moisture. If excessive moisture is in the tank, there may be a system malfunction. Contact your local John Deere dealer if assistance is needed.

Tire Pressure

⚠ CAUTION

When inflating a tire, use an extension with an in-line air gauge and attach air chuck. This will allow the operator to stand clear of tire sidewall explosion trajectory.

- Check tire pressure weekly.
- Never inflate a tire more than the maximum air pressure (as stated on the tire sidewall or in the tire specifications table provided in the *Introduction Section* of this manual).
- Use an airline with a locking air chuck and stand behind tire tread while filling.

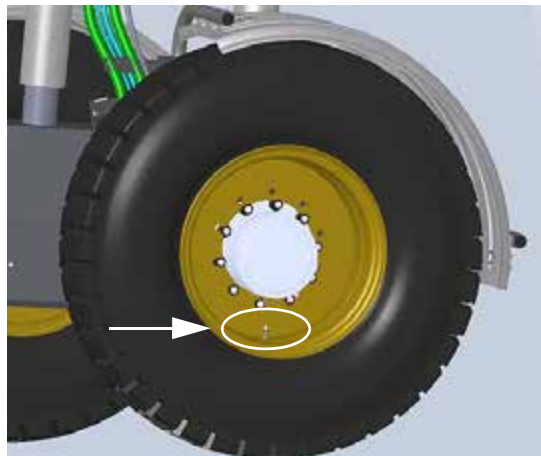

Valve Stem (4)
(Located on the outside of each wheel)
-Typical View

NOTE: Tire pressure will depend on type of tire used and amount of load.

Spray Booms

Nozzle Diaphragms

At the beginning of each season, remove each nozzle body cap (A) and inspect the diaphragm (B) for wear or fit. Replace diaphragms every 1,000 hours of operation, or as necessary.

Spray Tips

⚠ CAUTION

Never place a spray tip/nozzle to your mouth in an attempt to unplug it.

At the beginning of each season (or as required), remove a random sample of spray tip caps (C) and inspect the nozzle tips. If the tips are plugged or worn, clean or replace them. Replace spray tips every 1,000 hours of operation, or as necessary.

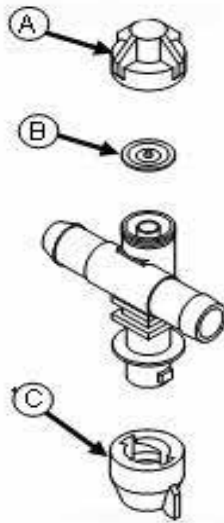

Nozzle Diaphragms and Spray Tips
-Typical View



Windshield Washer Fluid Spray Nozzle
(Located near top of front exterior cab)
-Typical View

Wiper Blades (Front/Side)

NOTICE

Use a sturdy stationary ladder to safely access the front wiper blade.

Do not allow the wiper blades to run on dry glass, as this will shorten the life of the blades and/or cause scratching of the cab glass.

NOTE: Replace the wiper blades as necessary.

- Front Wiper Blade - 39" (99 cm)
- Side Wiper Blades - 20" (50 cm)

The Windshield Washer Fluid and Deluge Spray Nozzles are adjustable. The fluid spray pattern should be inspected at the beginning of each season, and adjusted as necessary.

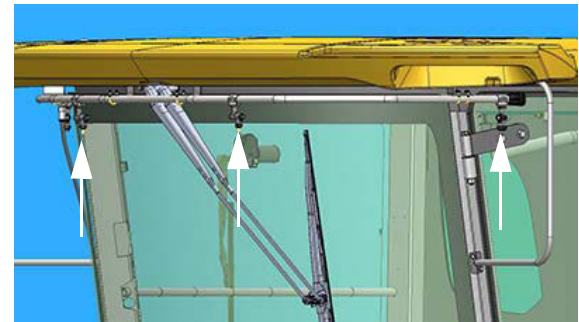

Deluge Spray Nozzles
(Located around exterior cab)
-Typical View

Washing the Machine

Wash the machine daily to remove any harmful chemical residue, which can be corrosive to paint and steel.

As often as possible, thoroughly wash the machine and apply paint to any place where the paint is light or missing.

For replacement decals or touch-up paint recommendations, contact your local John Deere dealer.



SERVICE INTERVALS

Service Point	Initial	Daily/ Before Each Use	As Required	50 Hrs.	100 Hrs.	250 Hrs. **	500 Hrs. **	1000 Hrs.
Check Lug Nut Torque (Break-in)	X							
Check Engine Oil Level		X						
Check Radiator Coolant Level		X						
Check Radiator Grille Screen		X						
Check Engine Drive Belt		X						
Check A/C Compressor Belt		X						
Check Hydraulic Reservoir Level		X						
Check Solution Line Strainer		X						
Check Batteries		X						
Check for Leaks Around the Machine		X						
Drain Air Tank		X						
Check Windshield Washer Fluid Level		X						
Check Deluge Solution Fluid Level		X						
Wash Machine Clean of Chemical Residue		X						
Check and Drain Primary Fuel Filter (Water Separator)		X						
Check Air Bags		X						
Check Engine Air Intake Piping		X						
Lubricate Boom Fold Grease Zerks (90/100')		X						
Lubricate Boom Breakaway Grease Zerks (90/100')		X						
Lubricate Boom Breakaway Cylinder Rod End Grease Zerks (90/100')		X						

SECTION 8 –
MAINTENANCE AND STORAGE



Service Point	Initial	Daily/ Before Each Use	As Required	50 Hrs.	100 Hrs.	250 Hrs. **	500 Hrs. **	1000 Hrs.
Check Aftertreatment DEF Tank Level (Tier 4 Final Engines)		X						
Check Aftertreatment DEF Exhaust Piping (Tier 4 Final Engines)		X						
Lubricate Leg Grease Zerks			X					
Replace Windshield Wiper Blade			X					
Replace Side Wiper Blades			X					
Fill Windshield Washer Fluid Reservoir			X					
Fill Deluge Solution Reservoir			X					
Inspect Plow Blade			X					
Clean Radiator Grille Screen			X					
Change Engine Drive Belt			X					
Change A/C Compressor Belt			X					
Charge A/C Compressor *			X					
Change Air Intake Filter (Filter Minder)			X					
Clean/Replace Solution Line Strainer			X					
Clean Hand Wash Strainer			X					
Clean Deluge System Strainer			X					
Check Spray Nozzle Diaphragms and Tips			X					
Change Batteries			X					
Change or Replace Fuses and Breakers			X					
Replace Charcoal Cab Filter			X					
Clean Cab Recirculation Filter			X					
Check Tire Pressure			X					
Lubricate Air Bag Collar Grease Zerk				X				



SECTION 8 –
MAINTENANCE AND STORAGE

Service Point	Initial	Daily/ Before Each Use	As Required	50 Hrs.	100 Hrs.	250 Hrs. **	500 Hrs. **	1000 Hrs.
Check Lug Nut Torque				X				
Lubricate Ladder Pivot Tube Grease Zerk				X				
Lubricate Boom Transom Pivot Tube Grease Zerks (90/100')				X				
Change Wheel Hub Oil (Break-in)				X				
Check Air Dryer Cartridge				X				
Check Wheel Hub Oil Level					X			
Clean Batteries					X			
Change Wheel Hub Oil						X		
Change Engine Oil							X	
Change Engine Oil Filter							X	
Change Primary Fuel Filter (Water Separator)							X	
Change Secondary Fuel Filter							X	
Change Hydraulic Return Filter							X	
Change Hydraulic Pressure Filter							X	
Change Hydraulic Charge Pump Filter							X	
Change Hydraulic Case Drain Filter							X	
Change Hydraulic Breather Cap							X	

SECTION 8 –
MAINTENANCE AND STORAGE



Service Point	Initial	Daily/ Before Each Use	As Required	50 Hrs.	100 Hrs.	250 Hrs. **	500 Hrs. **	1000 Hrs.
Check Radiator Coolant Concentration							X	
Change Hydraulic Reservoir Oil								X
Replace RESPA® Cab Filter								X
Change Radiator Coolant								X
Change Air Dryer Cartridge								X
Change Spray Nozzle Diaphragms and Tips								X
Exhaust Brake Service (contact engine manufacturer)								X

* Use proper equipment.

** 250-500 hours or yearly, whichever occurs first.

NOTE: Tier 4 Final Engines - Replace Aftertreatment Diesel Exhaust Fluid (DEF) Supply Module Filter every 4,500 hours of operation. Refer to the engine manufacturer's operation manual for further information.

Inspection Point	Action (if necessary)
Engine Oil Level	Add Oil
Radiator Coolant Level	Add Antifreeze Solution
Engine Drive Belt	Replace Belt
Filter Minder	Replace Air Filter Element
Hydraulic Reservoir Oil Level	Add Hydraulic Oil/Repair Leaks
Solution Line Strainer	Remove and Clean
Batteries	Clean and/or Tighten
Radiator Grille Screen	Clean
Look for Loose or Missing Items (e.g. shields)	Tighten or Replace
Look for any Fluid Leaks on Machine or Ground	Determine Cause and Correct
Fuel/Water Separator (Drain)	See "Service: Filters" elsewhere in this section
Air Tank (Drain)	See "Service: Miscellaneous" elsewhere in this section

STORAGE

Preparing For Storage

1. Perform daily level checks, lubrication, and bolt/linkage inspections, as required in this manual.
2. Every other season, drain the coolant from the engine and radiator. Probe the drain holes during drainage to ensure they are not clogged by sludge, scale, or other deposits.
Fill the cooling system to the top with a 50/50 water/antifreeze mixture. Run the engine to operating temperature and recheck level.
3. Add a fuel stabilizer to the fuel and fill the tank.
4. Run the engine until it reaches operating temperature, then drain the engine oil. Refill with fresh oil of recommended weight and install a new lubricating oil filter element.
5. With the engine at normal operating temperature, cycle all hydraulic functions, including the steering.
6. Release tension on all belts.
7. Use plastic bags and water-resistant adhesive tape to seal the air intake opening, all exhaust manifold openings, engine oil fill cap, hydraulic oil tank breather cap, and fuel tank cap.

NOTE: If the spray boom will be stored separately from the machine, ensure all boom hole openings are capped or covered with a suitable covering.

8. Tier 4 Final Engines - Plug the Diesel Exhaust Fluid (DEF) tank venting to seal tank exposure against environmental elements.
9. Turn the Battery Disconnect Switch OFF.
10. Disconnect and remove batteries. Completely clean and charge the batteries. Coat the terminals with dielectric grease and store the batteries in a cool place (above freezing).
11. Thoroughly wash the machine and its attachments. Touch up any painted surfaces that are scratched or chipped.

NOTE: For paint touch-up recommendations, contact your local John Deere dealer.

12. Replace worn or missing decals. Refer to “Safety Decals” in the *Safety and Precautions Section* for proper location of warning decals and corresponding part number.

NOTE: For decal replacement, contact your local John Deere dealer.

13. Apply multi-purpose grease to coat exposed hydraulic cylinder rods.
14. Refer to the Spray System Console manufacturer’s operation manual for detailed information on storage procedures for the console and flow meters.
15. If the machine must be stored outside, cover with a waterproof cover.

Winterization

To winterize the spray system, it is recommended that you use an environmentally safe RV-type antifreeze and water mixture that will give you adequate protection to -30° F.

- Drain any remaining solution in the spray system.
- Run antifreeze/water mixture through the spray system until it comes out all of the boom openings.

Winterizing the Hand Wash System

1. Remove Drain Plug (located beneath the hand wash reservoir) and allow fresh water to drain from tank.

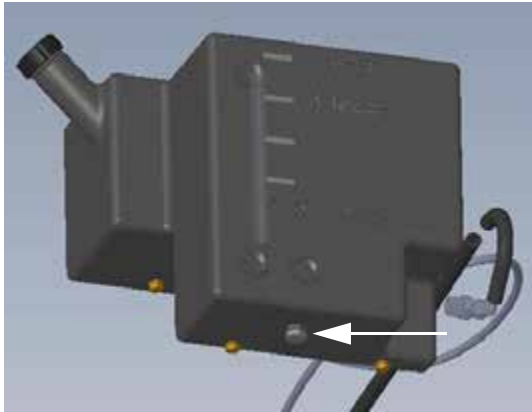

Drain Plug
(Located beneath the hand wash reservoir)
-Typical View

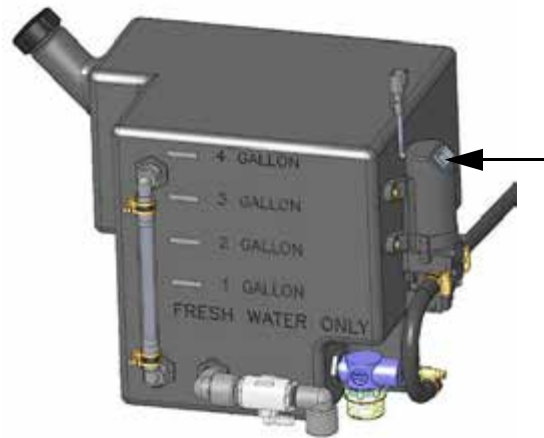

Hand Wash Pump Power Switch
(Located on top of pump)
-Typical View

2. Reinstall drain plug.
3. Pour approximately 1 gallon (3.8 L) of RV-type antifreeze into the Hand Wash Fill Port (located beneath platform near ladder).

5. Open the Hand Wash Valve (located near bottom of hand wash reservoir) until no antifreeze comes out of lower hand wash outlet. Close valve when finished.

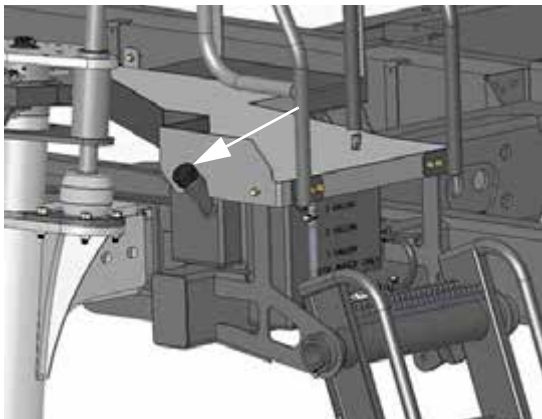

Hand Wash Fill Port
(Located beneath platform near ladder)
-Typical View

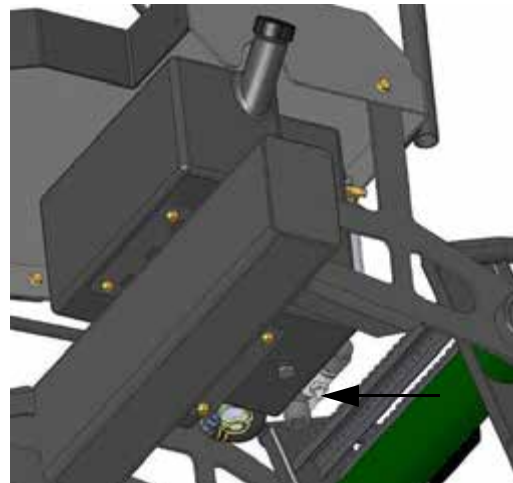

Hand Wash Valve
(Located near bottom
of hand wash reservoir)
-Typical View

4. Press the Hand Wash Pump Power Switch (located on top of pump) in the ON position.

6. Press and hold the Hand Wash Foot Pedal (located along the left-hand lower handrail) until no antifreeze comes out of the upper hand wash outlet. Release foot pedal when finished.



Hand Wash Foot Pedal
(Located along the left-hand lower handrail)
-Typical View

6. If the Hand Wash System was winterized prior to storage, fill hand wash reservoir with fresh water and drain before use.
7. Thoroughly clean the machine and its attachments.
8. Perform all recommended services as instructed elsewhere in this section.
9. Attach the spray boom and manually cycle all of the hydraulic functions 2 or 3 times to thoroughly lubricate the components.
10. Reset date and time on Machine Display.
11. For starting instructions, refer to “Engine - Starting” provided in the *Engine and Drive Systems Section* elsewhere in this manual.

7. Turn the Hand Wash Pump Power Switch OFF.

Removing From Storage

NOTICE

Protective compounds such as grease can harden under exposure to weather conditions. Be sure to remove any dried grease and reapply new, if necessary.

1. Inspect the condition of and test the air pressure of all tires.
2. Carefully unseal all openings that were previously sealed in the “Preparing for Storage” process.
3. Clean and reinstall the batteries. Be sure to attach the battery cables to the proper terminals.
4. Tighten all belts. Inspect and replace any worn belts.
5. Check the engine oil, hydraulic oil, and engine coolant levels, and add if necessary.

NOTE: A mixture of 50/50 water/antifreeze will cool adequately in the summer, as well as protect in winter.

TRANSPORTING

When driving on a public roadway or elsewhere, be aware of any situation where the sprayer will be passing under an object with a clearance lower than the transporting height of the machine.

⚠ CAUTION

Hagie Manufacturing Company does not recommend any form of transportation other than driving the sprayer. Loading the sprayer onto a trailer may result in machine rollover.

⚠ WARNING

- Never operate the sprayer on a public roadway with solution in the tank.
- Never load or unload the sprayer with solution in the tank.
- Stopping the sprayer on trailer ramps may result in the sprayer to tip over.

⚠ CAUTION

Do not operate the machine at speeds exceeding 20 mph (32 km/h) with solution in the tank. Operating speeds exceeding 20 mph (32 km/h) with a fully loaded tank may result in tire blow-out or wheel hub damage and will void the warranty.

⚠ WARNING

When transporting the sprayer, observe the following to avoid serious injury or death:

- Check for adequate clearance before driving under any overhead obstructions.
- Contact with power lines may result in serious injury or death.



⚠ CAUTION

Do not transport the machine without the booms folded and in cradles. Failure to comply may result in injury or equipment damage.

Cradling the Booms

⚠ CAUTION

Booms must be in the FOLDED position when cradled. Failure to comply will result in property damage.

NOTE: Always cradle the booms before traveling, transporting, or parking for an extended period of time.

- Fold the outer boom extensions IN.

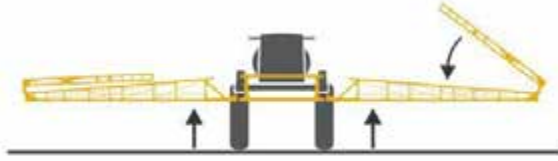

- Raise the transom all the way UP.
- Fold main boom sections IN toward the machine.



NOTE: When boom reaches the last 8-10 degrees of travel, it will automatically slow down to avoid impact with the cradle.

- Raise each individual boom until it clears the outer cradle stop.
- Fold the boom IN toward cradle back-stop.
- When boom touches the back-stop, lower until the full weight of the boom rests in the cradle.

Driving the Sprayer on a Public Roadway

1. Always have the booms in the folded and cradled position when driving or transporting the machine.
2. Use the flashing hazard/warning lights, day or night to warn other drivers, unless prohibited by law.
3. Know and obey all state laws for driving mobile machinery on a public roadway.
4. Adjust machine speed to suit the conditions.
5. Slow down and use turn signals before turning.
6. Pull over to the side of the road before stopping.
7. Keep a proper lookout and maintain control of the machine.
8. Do not drive under trees, bridges, wires, or other obstructions unless there is adequate clearance.

9. Use extra care before entering or exiting a public roadway.
10. Ensure the SMV (Slow Moving Vehicle) and SIS (Speed Indicator Symbol) emblems are properly displayed to warn other drivers, unless prohibited by law.
11. Do not drive the machine at speeds exceeding 20 mph (32 km/h) with solution in the tank. Operating speeds exceeding 20 mph (32 km/h) with a fully loaded tank may result in tire blow-out or wheel hub damage and will void the warranty.

Loading



WARNING

Keep all persons away from trailer when loading or unloading the sprayer. Failure to comply may result in serious injury or death.

NOTICE

Read and understand the trailer manufacturer's operation manual. Hitch the trailer to the pulling vehicle according to their recommendations.

NOTICE

The loaded height and width of the trailer must conform to state law in which it is being used. Do not exceed the trailer manufacturer's recommendations on loaded weight.

1. Pull the trailer to flat ground.
2. Apply the pulling vehicle's parking brake and turn the engine OFF.
3. Use tire chocks to keep the trailer from moving.
4. Fold the booms and lower into cradles.

5. Lower the trailer ramps and set the ramp spacing for the machine's tread width setting.
6. Have an attendant help guide you onto the trailer.
7. Allow enough room between the sprayer and the pulling vehicle for turning.
8. Secure the sprayer onto the trailer using the recommended securement restraints (see trailer manufacturer's operation manual).
9. Cover or remove the SMV (Slow Moving Vehicle) and SIS (Speed Indicator Symbol) emblems when traveling over 35 mph (55 km/h).



Contact your local John Deere dealer if towing is unavoidable.

Unloading

1. Pull the trailer to flat ground.
2. Apply the pulling vehicle's parking brake and turn the engine OFF.
3. Use tire chocks to keep the trailer from moving.
4. Lower the trailer ramps and set the ramp spacing for the machine's tread width setting.
5. Carefully release the securement restraints.
6. Have an attendant help guide you off of the trailer.
7. Uncover or replace the SMV and SIS emblems.

Towing

NOTICE

Sprayer should never be towed under any circumstances. Machine damage will occur and will void the power train warranty.

LIFTING YOUR MACHINE

WARNING

Do not lift machine by more than one or two lifting points at the same time. Failure to comply will cause the machine to become unstable, resulting in serious injury or death.

WARNING

Use extreme caution when supporting machine by a lifting point. Failure to obtain proper location and lifting equipment may cause the machine to become unstable, resulting in serious injury or death.

NOTICE

Lift machine on hard level surface with properly rated equipment only.



RISK OF INJURY DUE TO IMPROPER LIFTING.
DO NOT ATTEMPT TO LIFT MACHINE
WITHOUT JACKS PROPERLY SEATED IN THE
LIFTING POINT CONTAINMENT RINGS.

There are four (4) designated lifting points on the machine. These points are located on the frame near each leg and are equipped with containment rings for safe jack location.



Lifting Point Containment Ring
(Located on the frame near each leg)
-Typical View

To Lift Machine (Bottle Jacks)

1. Shut the engine off.

NOTE: The parking brake will engage automatically when the engine is shut off.

2. Place wood blocks in front and rear of the tires not being lifted.
3. Align jack with Lifting Point Containment Ring.



Align Jack with Lifting
Point Containment Ring
-Typical View

4. Connect air supply to jack.
5. Tap air supply handle and slowly insert jack into Lifting Point Containment Ring.



Insert Jack into Lifting
Point Containment Ring
-Typical View

6. Once jack is fully seated into the Lifting Point Containment Ring, continue to press and hold air supply handle until the machine reaches desired height.

⚠ WARNING

Ensure lock pins are fully inserted at base of jack. Do not rely on jack air supply to support a raised machine. Sudden loss of air pressure will cause the machine to become unstable, resulting in serious injury or death.

7. Install Lock Pins to the base of jack.



Lock Pin Installation
-Typical View

8. Reverse steps to lower machine.

QUICK-TACH SYSTEM - PLOW

⚠ WARNING

Clear area of personnel before connecting or disconnecting the plow.

⚠ WARNING

Turn the engine OFF before connecting or disconnecting any hoses or electrical lines. Failure to comply may result in serious injury or death.

Connecting the Plow

1. Square up to the plow attachment.
2. Disengage the Quick-Tach Lock Assemblies by pulling the Lock Pins (located on the front left and right-hand side of machine) OUT as far as it will go until it is in the “lock-out” position.

NOTE: “Lock-out” position prevents re-locking while attaching or detaching the attachment.



Lock Pin (2)
(Located on the front left and
right-hand side of machine)
-Typical View
Disengaged position shown

3. Slowly pull into the attachment.
4. Ensure the Attachment Hooks are high enough to clear the Mounting Pins.



Attachment Clearing Mounting Pin
-Typical View

5. If necessary, lower the machine by rotating the corresponding Air Suspension Valves (located on the left-hand front air bag) in the COUNTER-CLOCKWISE (Deflate) position.

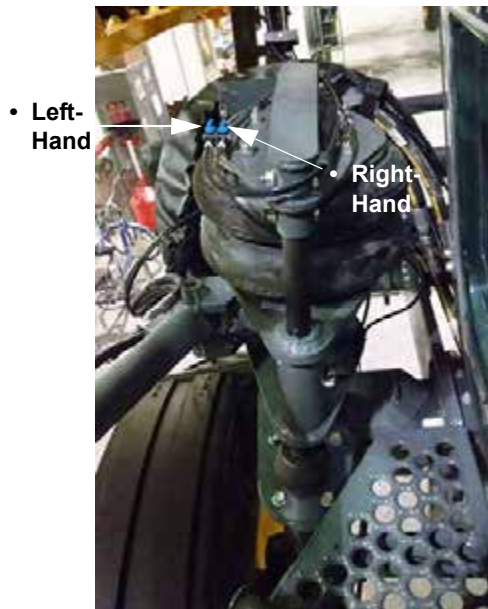

Air Suspension Valves
(Located on the left-hand front air bag)
-Typical View

6. Engage the parking brake.
7. Turn the engine OFF before connecting any hoses or electrical lines!
8. Install the Hydraulic and Electrical Connections (located on the back left and right-hand side of plow attachment) into the corresponding Multi-Coupler Quick

9. Push both Quick Connect Handles UP (right-hand multi-coupler)/OUT (left-hand multi-coupler) to engage hydraulic/electrical connections.*

Hydraulic Connection



Hydraulic Connection
(Located on front right-hand side of machine)
-Typical View
* Push UP to engage

Hydraulic/Electrical Connections



Hydraulic/Electrical Connections
(Located on front left-hand side of machine)
-Typical View
* Push OUT to engage

10. Start the engine.
11. If the air bags were previously deflated, raise the machine by rotating the corre-

sponding Air Suspension Valves in the CLOCKWISE (Inflate) position.

12. Press and hold the Transom Switch (located on the Hydrostatic Drive Control Handle) in the UP position to raise the plow until the Attachment Hooks fully engage.

NOTE: Press and hold the Transom Switch only until the Attachment Hooks become fully engaged.



Transom Switch - UP
(Located on the Hydrostatic Drive Control Handle)
-Typical View

NOTE: Raising the attachment will allow the weight of the plow to pull the Attachment Hooks over the Mounting Pins. You will notice a change of weight as the machine begins to support the attachment.

13. Engage the Quick-Tach Lock Assemblies by pushing the Lock Pins (on both sides of machine) IN, ensuring full engagement.

NOTE: If necessary, adjust the level cylinders to free the Lock Pins.



Lock Pin (2)
-Typical View
Engaged position shown

14. Install the Adjustable Bottom Link Arm by aligning holes of the link arm with the holes on the lower front machine frame and install Mounting Pin.

NOTE: Ensure the link arm is oriented correctly and the mounting pin handle is facing toward the inside of machine.

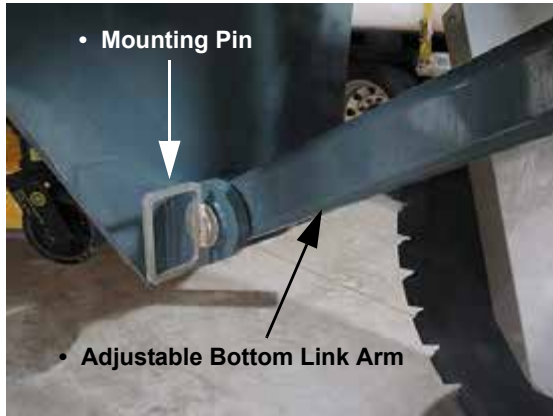

Adjustable Bottom Link Arm/
Mounting Pin Assembly - Lower
-Typical View



Adjustable Bottom Link Arm/
Mounting Pin Assembly - Upper
-Typical View

15. Install the provided Securement Bolt through the end of the previously installed Mounting Pin. Install nut to end of bolt and tighten to 13 ft.-lbs. using a 3/4" socket.

17. Install the provided Securement Bolt through the end of the previously installed Mounting Pin. Install nut to end of bolt and tighten to 13 ft.-lbs. using a 3/4" socket.



Securement Bolt/Nut Assembly - Lower
-Typical View



Securement Bolt/Nut Assembly - Upper
-Typical View

16. Raise opposite end of Adjustable Bottom Link Arm and align holes of the arm with the holes on the upper machine frame and insert Mounting Pin.

18. Raise the Adjustable Top Link Arm and align holes of the arm with the holes on the front machine frame and insert Mounting Pin.

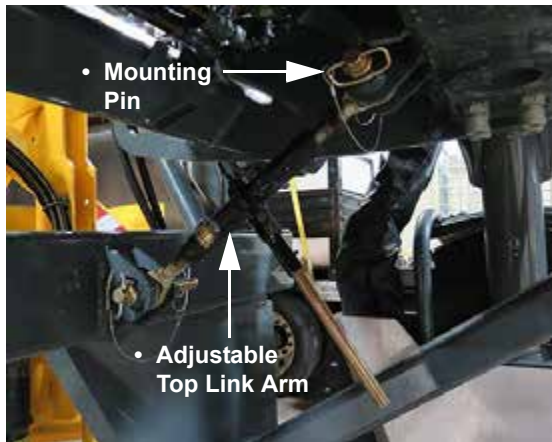

Adjustable Top Link Arm/
Mounting Pin Assembly
-Typical View

NOTE: When installing the Adjustable Top Link Arm Mounting Pin, it may be necessary to adjust the arm using the provided ratchet (located on the arm) to allow for clearance of the pin. Press the Adjustment Lever (located on the ratchet) and adjust as necessary.



Top Link Arm Adjustment
-Typical View

19. Install the provided Hairpin to the end of the previously installed Mounting Pin.

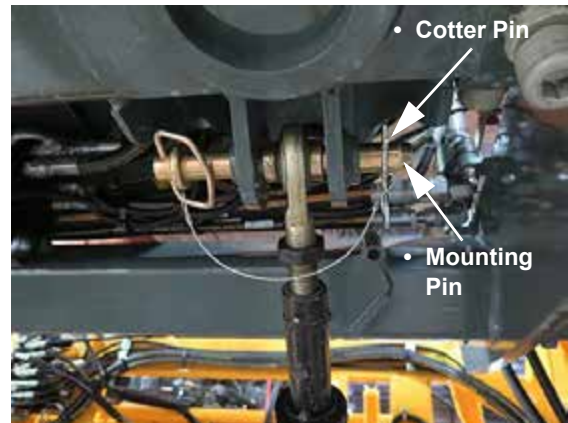

Mounting Pin/Hairpin Assembly
-Typical View

20. Repeat Steps 14 through 19 to install Adjustable Top and Bottom Link Arms on opposite side of machine.

Disconnecting the Plow



WARNING

Lower plow to the ground before disengaging the Quick-Tach Lock Assemblies.

1. Press the Float Button (located on the Machine Display Auxiliary Controls Page) to enable Float mode.

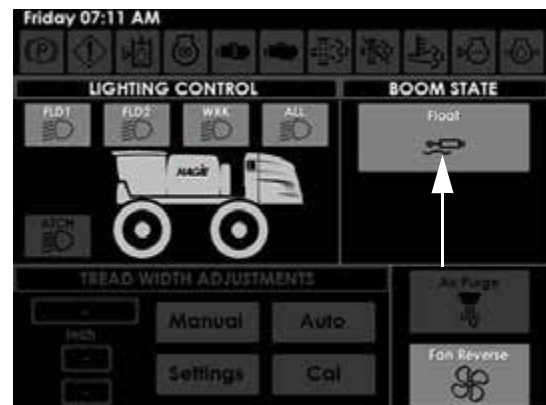

Float Button
(Located on the Machine Display
Auxiliary Controls Page)

2. Press (tap) the Transom Switch (located on the Hydrostatic Drive Control Handle) in the DOWN position to activate Float.



Transom Switch - DOWN
(Located on the Hydrostatic
Drive Control Handle)
-Typical View

3. Remove previously installed Hairpin and Mounting Pin from the top of the Adjustable Top Link Arm and allow arm to hang loose. Repeat for Adjustable Top Link Arm on opposite side of machine.

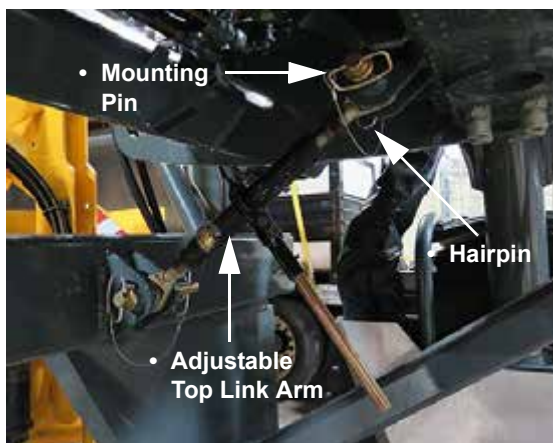

Adjustable Top Link Arm Assembly
-Typical View

4. Using a 3/4" socket, remove previously installed Securement Bolt/Nut Assembly located on the end of the Mounting Pin of the Adjustable Bottom Link Arm and set aside.



Securement Bolt/Nut Assembly
(Adjustable Bottom Link Arm - Upper)
-Typical View

5. Remove Mounting Pin and lower arm to the ground.

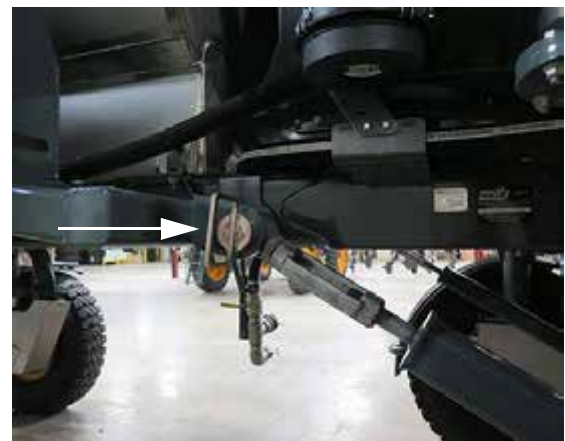

Mounting Pin
(Adjustable Bottom Link Arm - Upper)
-Typical View

6. Using a 3/4" socket, remove the previously installed Securement Bolt/Nut Assembly located on the end of the Mounting Pin of the lower Adjustable Bottom Link Arm and set aside.



Securement Bolt/Nut Assembly
(Adjustable Bottom Link Arm - Lower)
-Typical View

7. Remove Mounting Pin and set aside.
8. Repeat Steps 3 through 6 to remove Adjustable Bottom Link Arm on opposite side of machine.
9. Disengage the Quick-Tach Lock Assemblies by pulling the Lock Pins (located on the front left and right-hand side of machine) OUT as far as it will go until it is in the "lock-out" position.

NOTE: "Lock-out" position prevents re-locking while attaching or detaching the attachment.

NOTE: If necessary, adjust the level cylinders to free the Lock Pins.



Lock Pin (2)
(Located on the front left and
right-hand side of machine)
-Typical View
Disengaged position shown

10. If necessary, lower the machine by rotating the corresponding Air Suspension Valves (located on the left-hand front air bag) in the COUNTER-CLOCKWISE (Deflate) position.

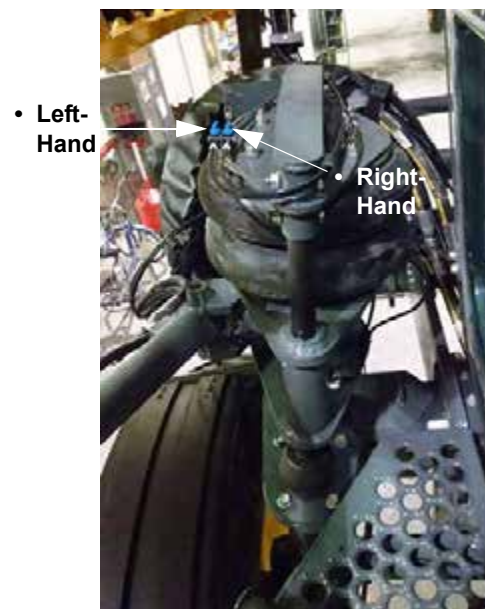

Air Suspension Valves
(Located on the left-hand front air bag)
-Typical View

11. Press the Transom Switch (located on the Hydrostatic Drive Control Handle) in the DOWN position and slowly lower the

transom until Attachment Hooks clear the Mounting Pins.



Transom Switch - DOWN
(Located on the Hydrostatic Drive Control Handle)
-Typical View

NOTE: If the air bags are inflated, a “bounce back” effect may be felt when the weight of the plow has been relieved from the machine. Once the air bags have cycled, the machine will adjust to the new weight.



Attachment Clearing Mounting Pin
-Typical View

12. Engage the parking brake.
13. Turn the engine OFF before disconnecting any hoses or electrical lines!
14. Push both Quick Connect Handles DOWN (right-hand multi-coupler)/IN

(left-hand multi-coupler) to disengage hydraulic/electrical connections.*

Hydraulic Connection



Hydraulic Connection
(Located on front right-hand side of machine)
-Typical View
* Push DOWN to disengage

Hydraulic/Electrical Connections



Hydraulic/Electrical Connections
(Located on front left-hand side of machine)
-Typical View
* Push IN to disengage

15. Remove the Hydraulic and Electrical Connections from the Multi-Coupler Quick Connect Receptacles (on each side of machine).
16. Re-lock the Quick-Tach Lock Assemblies (on each side of machine) by pushing the Lock Pins IN.
17. Start the machine.

18. Disengage the parking brake and slowly back away from the plow.
19. If the air bags were previously deflated, raise the machine by rotating the corresponding Air Suspension Valves in the CLOCKWISE (Inflate) position.

DELUGE SYSTEM

The Deluge System dispenses de-icer solution through the multiple adjustable spray nozzles located around the exterior cab to aid in melting ice and frost.

Filling the Deluge Solution Reservoir

The Deluge Solution Reservoir is located along the rear platform behind the solution tank. Check fluid level before each use and fill with de-icer solution as required.

NOTE: Deluge Solution Reservoir Capacity = 45 gallons (170 L)

1. Remove the deluge fill cap (located on top of reservoir) and set aside.



Deluge Fill Cap
(Located on top of reservoir)
-Typical View

2. Fill tank to desired level.
3. Reinstall deluge fill cap.

Deluge System Operation

1. Position the exterior deluge spray nozzles as desired.
2. Engage the parking brake.
3. Start the engine.
4. Press and hold the Deluge Switch (located on the side console) in the UP position to apply de-icer solution.

NOTE: The deluge pump (located beneath the reservoir) will activate when the Deluge Switch is depressed.

5. Release the Deluge Switch when desired amount of fluid is achieved.



Deluge Switch
(Located on the side console)
-Typical View

6. Press the desired Side Wiper Switch (located on each interior side wiper assembly) in the UP (On) position.

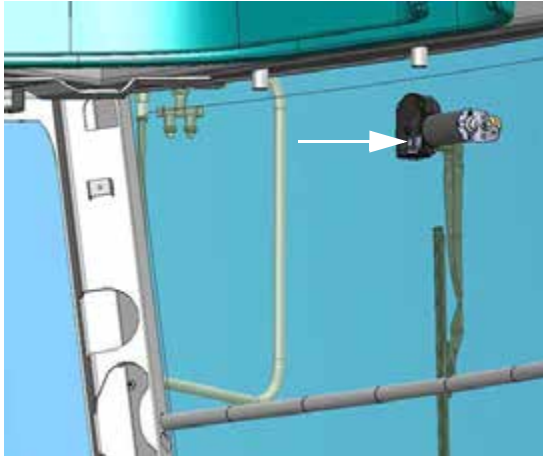

Side Wiper Switch
(Located on each interior side wiper assembly)
-Typical View

- When finished, press the Side Wiper Switch in the DOWN (Off) position.

Maintenance

Deluge Solution Strainer

An in-line strainer is located at the bottom of the deluge solution reservoir. Remove strainer and clean strainer screen periodically to avoid dirt and debris from entering the system and to ensure adequate flow.

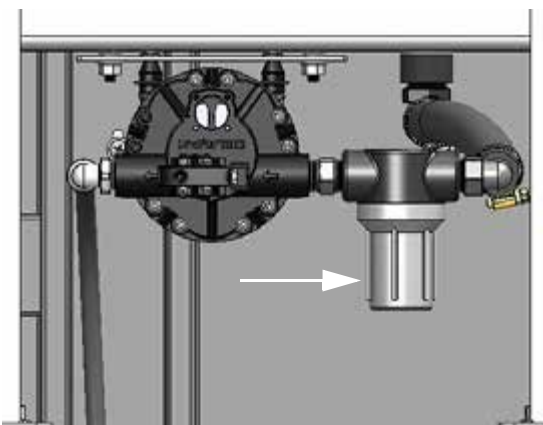

Deluge Solution Strainer
(Located near bottom of deluge solution reservoir)
-Typical View

Deluge Spray Nozzles (Adjustable)

At the beginning of each season (or if spray pattern deteriorates), remove spray nozzle cap and inspect for blockage.



Deluge Spray Nozzles
(Located around exterior cab)
-Typical View

HAND WASH SYSTEM

CAUTION

The Hand Wash System is not a substitute for Personal Protective Equipment (PPE). Always use the proper PPE (i.e. safety eye wear, face shields, protective clothing, etc.) when handling chemicals.

NOTICE

Keep the hand wash reservoir full of fresh water at all times for immediate use should contact with hazardous chemicals occur.

NOTICE

Fill the hand wash reservoir with fresh water only.

NOTICE

The Hand Wash System has been tested using RV-type antifreeze. Fill hand wash reservoir with fresh water and drain before initial use.

Your machine is featured with two Hand Wash Stations - one located near the bottom of the hand wash reservoir and the other mounted on the left-hand handrail near the cab door for your convenience in rinsing dirt and chemicals from hands before entering the cab.

The system uses a diaphragm-type water pump that can deliver up to 1 GPM (3.8 l/min) and is equipped with an in-line strainer to filter impurities and increase pump life. The water pump is also equipped with an internal pressure switch for on-demand use when the hand wash valves are opened. A power switch is located on the water pump to manually shut the pump down in the event of system failure (i.e. leaks, faulty pressure switch, etc.)

NOTE: The Hand Wash System is powered by battery power and will operate even when the machine is off.

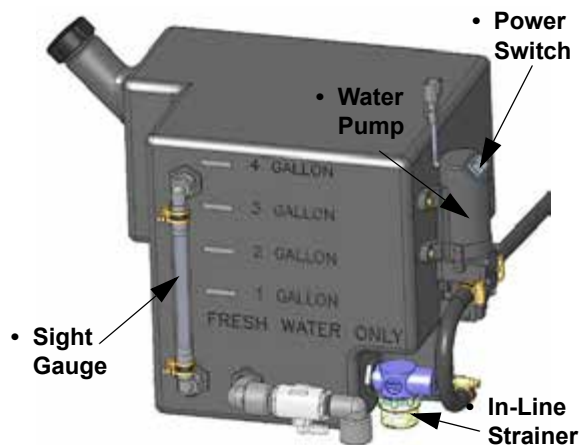

Hand Wash Reservoir
(Located beneath rear left-hand platform)
-Typical View

NOTE: Remove Hand Wash Strainer (located near the bottom of hand wash reservoir) and clean strainer screen periodically to avoid dirt and debris from entering the system.

Filling the Hand Wash Reservoir

NOTE: Hand Wash Reservoir Capacity = 4 gallons (15 L)

- Remove fill cap from the Hand Wash Fill Port (located near the ladder) and set aside.

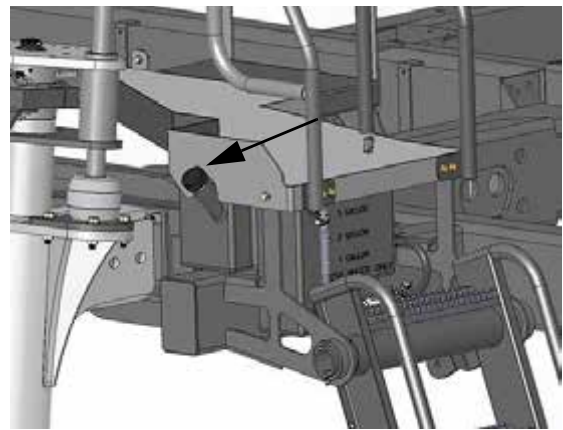

Hand Wash Fill Port
(Located near ladder)
-Typical View

- Pour fresh water down the fill port opening.

NOTE: A sight gauge is located on the side of the hand wash reservoir to visually check water level.

- Reinstall fill cap.

Dispensing Fresh Water

To Dispense Fresh Water From Upper Water Outlet

- Press and hold the Hand Wash Foot Pedal (located along the lower handrail on left-hand side of machine).



Upper Water Outlet/Hand Wash Foot Pedal
(Mounted on left-hand handrail near cab door)
-Typical View

- Release foot pedal when finished.

To Dispense Fresh Water From Lower Water Outlet

- Rotate the Hand Wash Valve (located near the bottom of hand wash reservoir) in the “clockwise” position to OPEN.

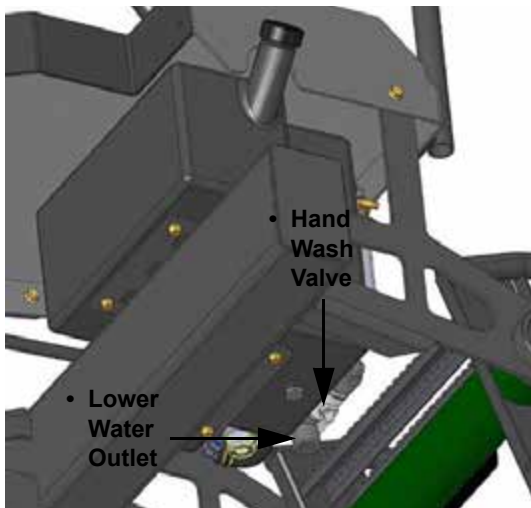

Lower Water Outlet/Hand Wash Valve
(Located near the bottom of hand wash reservoir)
-Typical View

- Rotate the Hand Wash Valve in the “counter-clockwise” position to CLOSE.

AIR SUSPENSION EXHAUST

(Air Bags)

The Air Suspension Exhaust System is used to manually inflate/deflate the air bags on your machine, providing you with a smooth, consistent ride quality. It also provides ease when connecting and disconnecting attachments.

NOTE: Inspect air bags daily for leaks and/or cracking.

To Inflate/Deflate the Air Bags

- Rotate the corresponding Air Suspension Valves (located on the left-hand front and rear air bags) in the COUNTER-CLOCKWISE position to deflate.
- Rotate the corresponding Air Suspension Valves in the CLOCKWISE position to inflate.

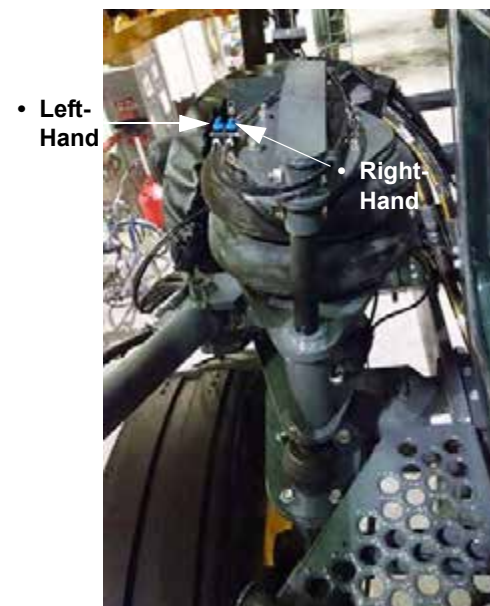

Air Suspension Valves
(Located on the left-hand front and rear air bags)
-Typical View

* Front left-hand air bag shown

HOOD OPERATION

The rear hood may be opened to access many of the machine's service points (e.g. engine and hydraulic components).

To Open Hood

- Unlock the two Hood Latches (located on each side of top hood).



Hood Latch (2)
(Located on each side of top hood)
-Typical View

- Press and hold the Hood Switch (located ahead of rear hood above the radiator screen) in the LEFT position (when facing rear of machine).
- Release Hood Switch when hood has opened to desired position.



Hood Switch
(Located ahead of rear hood
above the radiator screen)
-Typical View

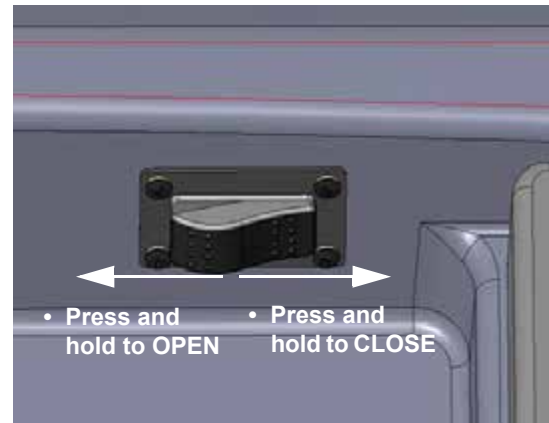

-Typical View

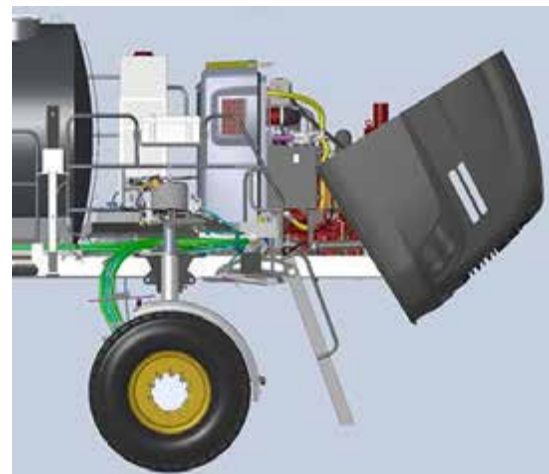

Rear Hood
(Open position shown)
-Typical View

To Close Hood

- Press and hold the Hood Switch in the RIGHT position (when facing rear of machine) until hood is fully retracted and comes to a complete stop.



Rear Hood
(Closed position shown)
-Typical View

- Lock the two Hood Latches.

Powering the Hood Actuator (when battery charge is depleted)

Refer to “Engine - Starting” provided in the *Engine and Drive Systems Section* elsewhere in this manual for information on jump starting the machine.

TROUBLESHOOTING

Problem	Possible Cause	Suggested Remedy
Engine will not crank	<ul style="list-style-type: none"> • Dead battery • Poor battery connections • Starter or starter relay • Blown fuse in engine electric box • Battery Disconnect Switch in the OFF position • Parking brake not engaged 	<ul style="list-style-type: none"> • Recharge or replace battery • Clean and tighten connections • Test (rebuild or replace) • Check/replace fuse • Turn Battery Disconnect Switch to the ON position • Engage parking brake
Engine will not start	<ul style="list-style-type: none"> • Fuel tank empty • Clogged fuel filter(s) • Cold weather • E-Stop Switch is engaged • Low starter speed • Blown fuse in engine box 	<ul style="list-style-type: none"> • Fill fuel tank • Replace fuel filter(s) • Refer to the engine manufacturer's operation manual for cold weather starting • Disengage E-Stop Switch • Check starter and battery • Check/replace fuse
Engine overheats	<ul style="list-style-type: none"> • Engine overload • Dirty radiator core/grille screen • Faulty radiator cap • Fan malfunction • Faulty thermostat • Low coolant level 	<ul style="list-style-type: none"> • Reduce load • Remove foreign material and clean all items • Replace radiator cap • Check fan speed • Replace thermostat • Refill to proper level with recommended coolant
Engine misfires (runs uneven/low power)	<ul style="list-style-type: none"> • Water in fuel • Dirty air cleaner element • Poor grade of fuel • Fuel tank vent clogged • Clogged fuel filter(s) 	<ul style="list-style-type: none"> • Drain, flush, replace filter, fill system • Replace air cleaner element • Drain system, change to a higher fuel grade • Open fuel tank vent (in cap) • Replace fuel filter(s)
Engine knocks	<ul style="list-style-type: none"> • Low oil level in crankcase • Cold engine 	<ul style="list-style-type: none"> • Add oil to full mark • Allow proper warm-up period, refer to engine manufacturer's operation manual
Solution Pump will not prime	<ul style="list-style-type: none"> • Low water level in pump • Air leak in suction line • Solution tank valve closed • Clogged or kinked vent line 	<ul style="list-style-type: none"> • Ensure solution tank is not empty (solution pump is self-priming) • Inspect and tighten all fittings in suction line • Open solution tank valve, allow air to leave the system • Inspect vent line for blockage or kinking



Erratic reading on pressure gauge	<ul style="list-style-type: none"> • Orifice in back of gauge clogged • Faulty gauge • Air leak in suction line • Solution strainer plugged • Glycerin leaking from pressure gauge 	<ul style="list-style-type: none"> • Remove gauge, clean orifice, reinstall • Replace gauge • Inspect and tighten all fittings in suction line • Check solution strainer • Replace gauge
Electric solution valve malfunction	<ul style="list-style-type: none"> • Faulty ground • Dirty contact terminals • Separation in wire • Faulty switch • Bad valve 	<ul style="list-style-type: none"> • Clean and tighten ground • Clean contact terminals • Check continuity and replace wire • Replace switch • Replace valve
Solution pump not producing adequate pressure	<ul style="list-style-type: none"> • Clogged line strainer screen • Air leak in suction flow to pump • Restricted solution flow to pump • Suction hose collapsed • Hydraulic failure 	<ul style="list-style-type: none"> • Remove screen, clean thoroughly, tighten strainer cap to avoid air leak • Inspect and tighten all fittings on suction line • Ensure Main Tank Valve is completely open • Obstruction at inlet end of hose causing high vacuum on hose • Contact your local John Deere dealer for assistance
Machine will not move in either direction	<ul style="list-style-type: none"> • Engine speed too low • Oil level in hydraulic reservoir too low • Clogged pressure filter • Hydrostatic System failure 	<ul style="list-style-type: none"> • Set engine at operating RPM • Fill hydraulic reservoir to proper level with approved oil • Replace pressure filter • Contact your local John Deere dealer for assistance
Machine will move in only one direction	<ul style="list-style-type: none"> • Hydrostatic System failure 	<ul style="list-style-type: none"> • Contact your local John Deere dealer for assistance
Hydrostatic system responding slowly	<ul style="list-style-type: none"> • Engine speed too low • Oil in hydraulic reservoir low • Cold oil • Plugged filter • Partially restricted suction line • Hydrostatic System failure 	<ul style="list-style-type: none"> • Set engine at operating RPM • Fill hydraulic reservoir to proper level with approved oil • Allow adequate warm-up period • Check and replace filter • Inspect for collapsed suction hose • Contact your local John Deere dealer for assistance
Noisy hydrostatic system	<ul style="list-style-type: none"> • Cold oil • Low engine speed • Oil level in hydraulic reservoir low • Hydrostatic System failure 	<ul style="list-style-type: none"> • Allow adequate warm-up period • Increase engine speed • Fill hydraulic reservoir to proper level with approved oil • Contact your local John Deere dealer for assistance

SECTION 9 –
MISCELLANEOUS



Entire hydraulic system fails to function	<ul style="list-style-type: none"> • Oil level in hydraulic reservoir too low • Auxiliary hydraulic system failure 	<ul style="list-style-type: none"> • Fill hydraulic reservoir to proper level with approved oil • Contact your local John Deere dealer for assistance
Noisy hydraulic pump	<ul style="list-style-type: none"> • Oil level in hydraulic reservoir too low • Auxiliary hydraulic system failure 	<ul style="list-style-type: none"> • Fill hydraulic reservoir to proper level with approved oil • Contact your local John Deere dealer for assistance
AWS System will not turn on	<ul style="list-style-type: none"> • AWS Button (located on the Machine Display) is OFF • Machine not in Field Mode • Sensor or valve malfunction 	<ul style="list-style-type: none"> • Turn AWS Button ON • Change machine's drive state to Field Mode • Contact your local John Deere dealer for assistance
AWS System is ON, but rear tires do not follow behind the front tires	<ul style="list-style-type: none"> • Machine speed is greater than AWS shutoff speed • Sensor or valve malfunction 	<ul style="list-style-type: none"> • This is left up to the operator's discretion • Contact your local John Deere dealer for assistance
AWS System inoperable, machine will only move at slow speed	<ul style="list-style-type: none"> • Sensor malfunction 	<ul style="list-style-type: none"> • Move the Hydrostatic Drive Control Handle to NEUTRAL, wait for the "FAULT" drive state to disappear on the Machine Display, and restart machine <p><i>NOTE: In Road mode, the rear tires are locked until the machine is put into Field mode.</i></p>
Entire electrical system is dead	<ul style="list-style-type: none"> • Dead battery • Poor battery connection • Low charge rate • No charge rate • Battery Disconnect Switch is in the OFF position 	<ul style="list-style-type: none"> • Replace battery • Clean and tighten battery connections • Tighten alternator belt • Replace alternator • Turn Battery Disconnect Switch to the ON position
Light system does not function	<ul style="list-style-type: none"> • Poor ground • Burned out bulb • Separation or short in wire • Blown fuse • Faulty switch • Ignition switch is OFF 	<ul style="list-style-type: none"> • Clean and tighten ground • Replace bulb • Check continuity and replace wire • Replace fuse • Replace switch • Turn ignition switch ON



INDEX

2017 Product Warranty	1-14	Service - Bolt Torque	8-24
A Word From Hagie Manufacturing		Service - Engine Drive Belt	8-23
Company	1-1	Service - Filters	8-10
About This Manual	1-1	Service - Fluids	8-1
Air Suspension Exhaust	9-16	Service - Lubrication	8-21
All-Wheel Steer (AWS)	4-14	Service - Miscellaneous	8-27
Application	7-18	Service - Toe-In	8-25
Batteries	6-1	Service and Assistance	1-2
Battery Disconnect Switch	6-2	Service Intervals	8-30
Battery Tender	6-3	Solution System - Operation	7-13
Deluge System	9-13	Solution System Components	7-6
Draining Your Solution Tank	7-17	Specifications	1-5
Emergency Exit	2-8	Spray Booms - 90/100'	7-1
Emergency Stop	2-7	Storage	8-34
Engine - Starting	4-1	Transporting	9-1
Engine Aftertreatment - Tier 4 Final	4-3	Troubleshooting	9-19
Filling Your Solution Tank	7-16	Video Camera Input Connections	6-12
Fire Extinguisher	2-8		
First Aid Kit	2-8		
Fuse and Relay Ratings	6-9		
Fuses and Relays	6-4		
Hand Wash System	9-14		
Hood Operation	9-17		
Hydraulic System Components	5-1		
Hydrostatic Drive	4-10		
Identification	1-2		
Intended Use	2-1		
Ladder	5-5		
Lifting Your Machine	9-3		
Machine Display	3-25		
Operator's Station	3-3		
Plow - Operation	3-51		
Quick-Tach System - Plow	9-5		
Reversible Fan	5-4		
Rotating Beacons	2-7		
Safety Decals	2-9		
Safety Messages Used In This			
Manual	1-2		
Safety Precautions	2-1		
Seat - Instructor	3-3		
Seat - Operator (Premium)	3-1		
Seat Belt	2-6		

