

CALIFORNIA

Proposition 65 Warning

WARNING: Diesel engine exhaust and some of its constituents are known to the State of California to cause cancer and birth defects or other reproductive harm.

WARNING: Battery posts, terminals, and related accessories contain lead and lead compounds, chemicals known to the State of California to cause cancer and birth defects or other reproductive harm.



ANY PICTURES CONTAINED WITHIN THIS OPERATOR'S MANUAL THAT DEPICT SITUATIONS WITH SHIELDS, GUARDS, RAILS, OR LIDS REMOVED ARE FOR DEMONSTRATION PURPOSES ONLY. HAGIE MANUFACTURING COMPANY STRONGLY URGES THE OPERATOR TO KEEP ALL SHIELDS AND SAFETY DEVICES IN PLACE AT ALL TIMES.



**OPERATOR'S MANUAL
FOR
HAGIE MODEL GST 20 HI-TRACTOR**

HAGIE MANUFACTURING COMPANY

721 CENTRAL AVENUE WEST
BOX 273
CLARION, IOWA 50525-0273

(515) 532-2861

COVERS MACHINE SERIAL NUMBERS:U1620901001 thru U1620901100

01-10 493483

TO THE OWNER



A WORD FROM HAGIE MANUFACTURING COMPANY

Congratulations on your selection of a Hagie Model GST 20. We recommend that you study this Operator's Manual and become acquainted with the adjustments and operating procedures before attempting to operate your new GST. As with any piece of equipment, certain operating procedures, service, and maintenance are required to keep it in top running condition.

We have attempted herein to cover all of the adjustments required to fit varying conditions. However, there may be times when special care must be considered.

Hagie Manufacturing Company reserves the right to make changes in the design and material of any subsequent GST without obligation to existing units.

We thank you for choosing a Hagie GST and assure you of our continued interest in its satisfactory operation for you. If we might be of assistance to you, please call us.

We are proud to have you as a customer.



TO THE OPERATOR

The following pages and illustrations will help you operate and service your new GST. It is the responsibility of the user to read the Operator's Manual and comply with the safe correct operating procedures and lubricate and maintain the product according to the maintenance schedule.

The user is responsible for inspecting the machine and having parts repaired or replaced when continued use of the product causes damage

or excessive wear to other parts.

Keep this manual in a convenient place for easy reference when problems arise. This manual is considered a permanent fixture with this machine. In the event of resale, this manual should accompany the GST. If you do not understand any part of the manual or require additional information or service, contact the Hagie Customer Support Department:

Hagie Manufacturing Company
 721 Central Avenue West
 Box 273
 Clarion, IA 50525-0273
 (515) 532-2861



<p>The following symbols, found throughout this manual, alert you to potentially dangerous conditions to the operator, service personnel, or the equipment.</p>	
	<p><i>This symbol indicates a hazardous situation which, if not avoided, will result in death or serious injury.</i></p>
	<p><i>This symbol indicates a potentially hazardous situation which, if not avoided, could result in death or injury.</i></p>
	<p><i>This symbol indicates a potentially hazardous situation which, if not avoided, may result in minor or moderate injury. It may also be used to alert against unsafe practices.</i></p>

TABLE OF CONTENTS

I.	SAFETY/DECALS.....	4-12
II.	TRACTOR IDENTIFICATION.....	13-14
III.	SPECIFICATIONS.....	15-20
IV.	OPERATING INFORMATION.....	21-63
V.	CALIBRATION.....	64-74
VI.	TRANSPORTING.....	75-77
VII.	SERVICE AND MAINTENANCE.....	78-100
VIII.	STORAGE.....	101-102
IX.	TROUBLE SHOOTING.....	103-111
X.	LIMITED WARRANTY.....	112
X.	INDEX.....	113-118

I. SAFETY/DECALS

SAFETY PRECAUTIONS

Most accidents occur as the result of failure to follow simple and fundamental safety rules. For this reason, most accidents can be prevented by recognizing the real cause and doing something about it before the accident occurs.

Many conditions cannot be completely safeguarded against without interfering with efficient operation and/or reasonable accessibility. Therefore, you must study this Operator's Manual

and learn how to use the GST's controls for safe operation. Likewise, do not let anyone operate without instruction.

Do not make modifications such as weldments, add-ons, adaptations, or changes from the original design of GST. Such changes and/or modifications may become safety hazards to you and to others and will void all warranties.



DRIVING

- Before moving the GST, make sure no persons or obstructions are in the path of travel.
- Do not permit passengers on the GST when it is moving; they may fall off or obstruct the operator's view.
- Never drive near ditches, embankments, holes, mounds, or other obstacles.
- Never drive on hills too steep for safe operation.
- Always drive at a reasonable field speed.
- Reduce the GST's speed before turning.
- Come to a complete stop before reversing direction.
- Pull over to side of road before stopping.
- Additional weight caused from partially full or full solution tanks may cause erratic or increased stopping distance.
- Never operate GST on roadway with any solution in solution tank.
- Do not activate parking brake while machine is in motion or damage may occur to the GST.
- Use flashing/hazard warning lights when traveling on public roads, day or night, unless prohibited by local law.
- Make sure SMV and SIS emblem is in place and visible from rear when traveling on public roads.

I. SAFETY/DECALS

OPERATING

EDGE LIGHT PLOW

- Make sure personnel are clear of the area when operating the plow.
- Keep the plow in down position when performing maintenance.

GST 20 TRACTOR BOOMS

- Cradle booms when leaving GST unattended.
- Make sure booms are folded when cradled.
- Select a safe area before unfolding booms. Avoid power lines and overhead structures.

GENERAL OPERATION SAFETY

- Do not adjust factory engine RPM settings.
- Operate engine at one bump to assure proper charge pressure for brakes to work properly.
- Start engine from operator's seat only. Do not by-pass safety-start switch.
- Never use starting fluid to assist engine start up.
- Never run the GST's engine in a closed building. Proper exhaust ventilation is required.
- If equipped with ground speed sensing radar, do not look directly into radar beam. It emits a very low intensity microwave signal which may cause possible eye damage.

I. SAFETY/DECALS

REPAIR/MAINTENANCE

HYDRAULICS

- Use caution when working with hydraulic fluid under pressure. Escaping hydraulic fluid can have sufficient enough force to penetrate your skin causing serious injury. This fluid may also be hot enough to burn.
- Always lower load or relieve hydraulic pressure before repairing a hydraulic oil leak.
- Avoid torching, welding, and soldering near pressurized hydraulic lines.

FUELING

- Always turn engine off and allow it to cool before refueling.
- Do not smoke while refueling.
- Do not fill fuel tank completely. Fuel may expand and run over.

GENERAL REPAIR/MAINTENANCE

- Turn off engine before checking, adjusting, repairing, lubricating, or cleaning any part of the GST.
- When servicing radiator, let engine cool before removing pressurized cap.
- Disconnect battery ground cable and turn main battery switch off before servicing electrical system or welding on machine.
- When charging battery, connect positive cable to positive terminal and negative cable to negative terminal. Failure to do so may result in an explosion and cause injury. Likewise, avoid battery acid contact with body.

I. SAFETY/DECALS

CHEMICAL HANDLING

- Never allow chemicals to come in contact with skin or eyes. Wear protective clothing or respirators as recommended by chemical manufacturer. Store this clothing outside of the cab so as not to contaminate the filtered cab environment. Also, clean your boots to remove soil or other contaminated particles prior to entering cab.
- Never pour chemicals into an empty tank, fill tank half full of water first.
- Follow chemical manufacturer's instructions for mixing chemicals.
- Dispose of empty chemical containers properly.
- Wash spilled chemicals or spray residue from GST to prevent corrosion and deterioration.
- Select a safe area to fill, flush, calibrate, and clean the GST where chemicals will not drift or run off to contaminate people, animals, vegetation, or water supply.
- Never place nozzle tips or other parts to one's lips in an attempt to unclog spray tip.
- Do not spray when wind is in excess of chemical manufacturer's recommended speed.
- Store pesticides in their original containers with label intact. Keep them in a separate, locked building.

GENERAL SAFETY

- Keep a fire extinguisher close at all times.
- Keep all shields in place.
- Keep clear of all moving parts and keep others away when operating.
- Do not wear loose fitting clothing that may be blown or drawn into moving parts.

I. SAFETY/ DECALS

WARNING DECALS

Decals warning you of avoidable danger are located on various parts of the GST. They are there for your personal safety and protection. DO NOT remove them. They will fracture upon attempted removal and therefore must be replaced.

Following are locations of important safety decals. Replace them if they are torn or missing. All

warning decals and other instructional Hagie decals or machine striping may be purchased through Hagie Customer Support Department. To replace decals, be sure the installation area is clean and dry; decide on exact position before you remove the backing paper.

DECAL LOCATION



650107

Rear of mainframe above booster terminals.



650118

On engine compartment, in front of air intake.



I. SAFETY/ DECALS



650164

Left side rear cab post.



650165

Right side rear cab post.

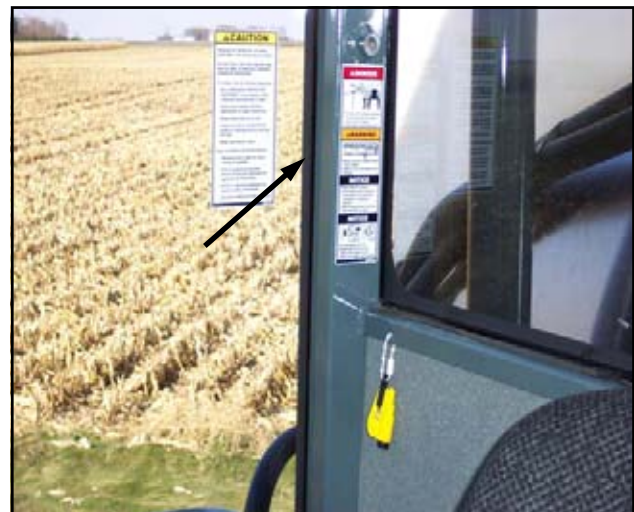

650174

In engine compartment, on radiator.



I. SAFETY/ DECALS



650176

Inside right-hand cab post by rear window.

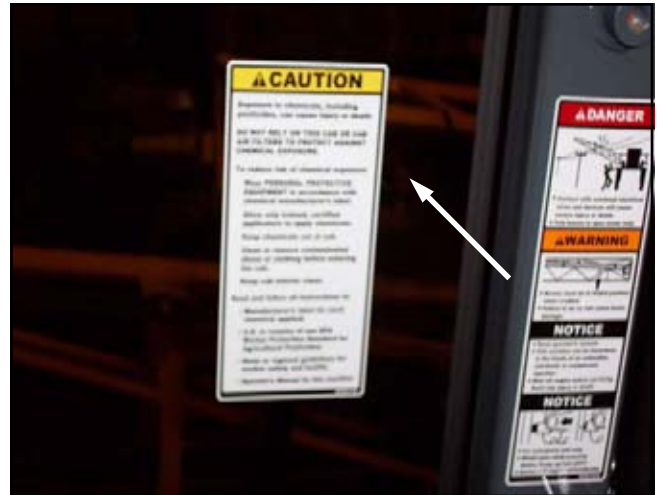

650178

Quick attach mount.

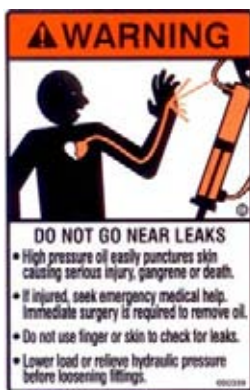

650339

On front cross member, left side (picture 1)

On hydraulic reservoir, to left of sight gauge (picture 2)

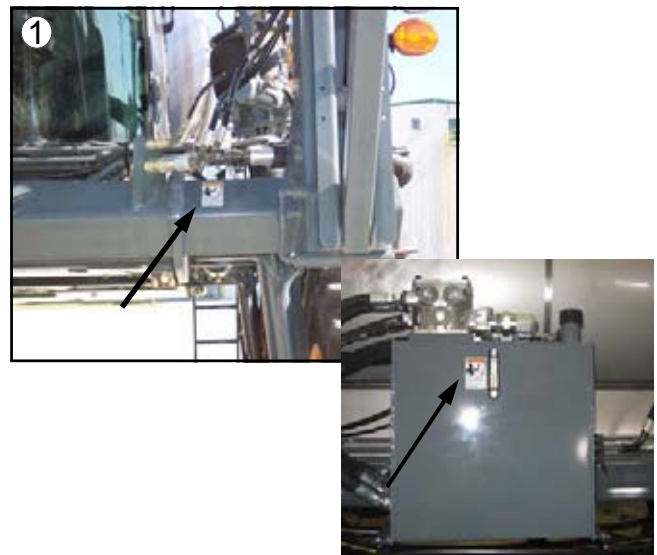

②

I. SAFETY/ DECALS



650848

On ladder pivot tube.

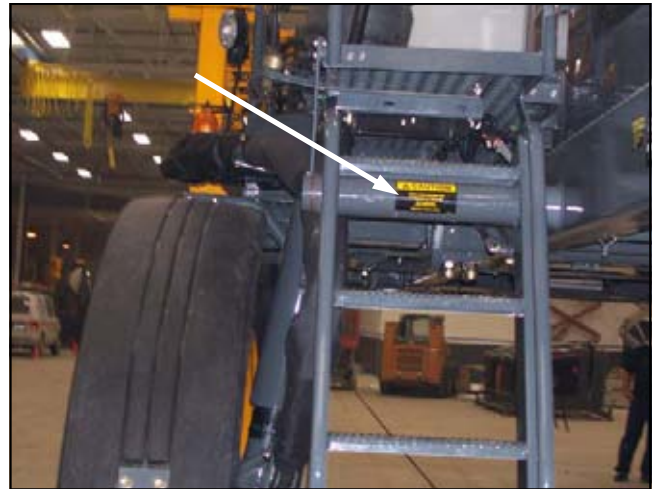

650849

On engine compartment, near fuel cell cap.



650850

On solution tank, near fill lid.

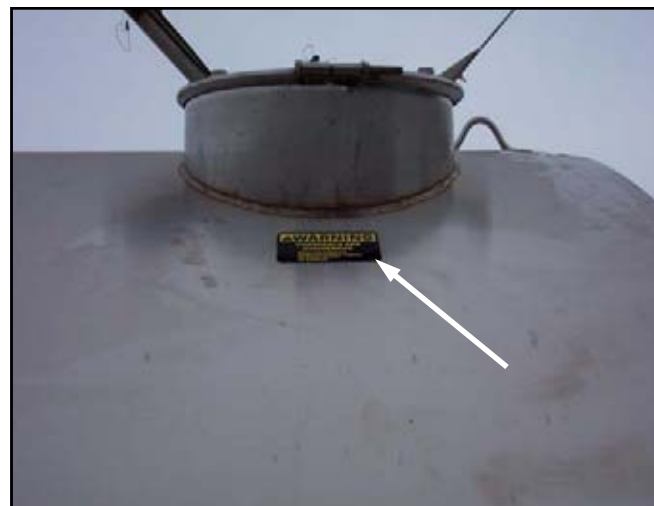

I. SAFETY/ DECALS



Left rear mainframe.

650851



650981

In engine compartment, near radiator cap.

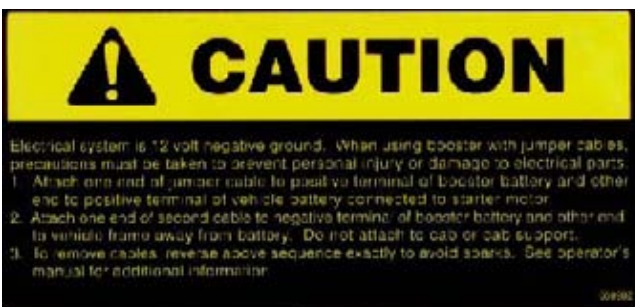

650982

On fuel cell near batteries.



II. IDENTIFICATION NUMBERS

GST IDENTIFICATION

Each Hagie tractor is identified by means of a frame serial number. This serial number denotes the model, year in which it was built, and the number of the tractor. For further identification, the engine has a serial number, the hydrostatic pumps have serial numbers, the wheel motors have identification tags, and the planetary hubs have

identification plates that describe the type of mount and gear ratio. To ensure prompt, efficient service when ordering parts or requesting service repairs from Hagie Manufacturing Company, record the serial and identification numbers in the space provided below.

NOTE:

Reference to left-hand and right-hand used throughout this manual refers to the position when seated in the operator's seat facing forward.

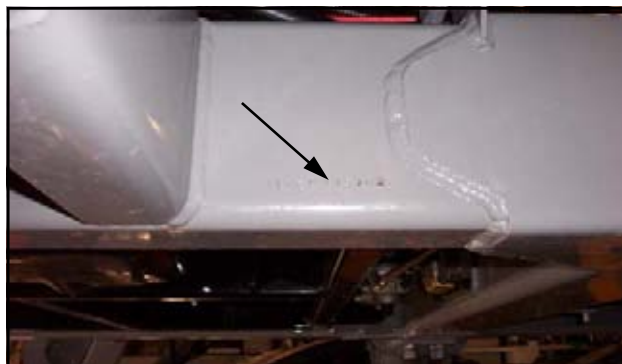

GST

NOTE: GST serial number stamped in the frame on right rear corner.



Engine

NOTE: Diesel engine serial number located on the valve cover.

II. IDENTIFICATION NUMBERS

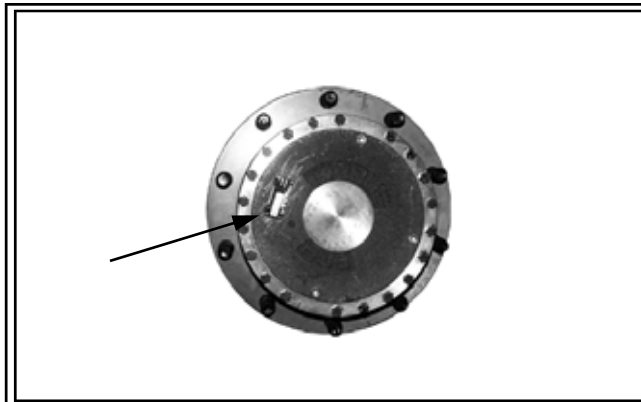

Planetary Hubs

Left

Right

Front: _____

Rear: _____

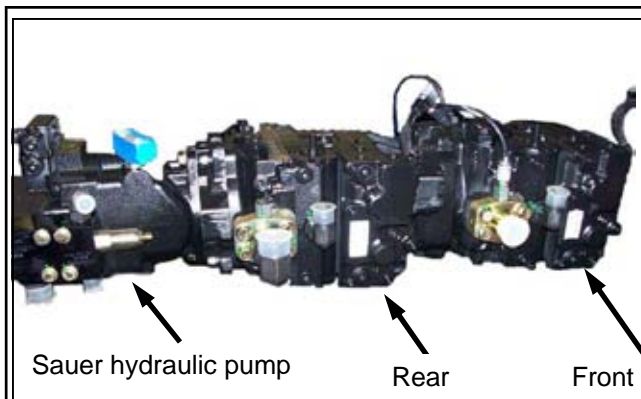

Hydrostatic Pumps

Front: _____

Rear: _____



Front Wheel Motors

Left: _____

Right: _____

Refer to parts manual.



Rear Wheel Motors

Left - w/
Sensor: _____

Right - w/o
Sensor: _____

Refer to parts manual.

III. SPECIFICATIONS

ENGINE

Manufacturer and model	Cummins
Model	QSB6.7-275
Type.....	Electronic with air to air cooler and turbocharger
Number of cylinders	6
Displacement.....	6.7 liter (360 c.i.)
Power	275 hp (205 kW), intermittent
Type of fuel.....	Number 1 or number 2 diesel
Fuel system	Filtered, direct-injected
Air cleaner	Dry-type, Duel element
Engine air filter restriction monitor.....	Filter Minder®
Slow idle	800 RPM
Fast idle	2500 RPM (no load)

POWER TRAIN

Drive

Hydrostatic pump	Sauer-Danfoss Tandem 90 series
Displacement.....	150cc (75 X 2) with electronic displacement control
Drive train	All-time four wheel drive
Speed ranges	- 6 work mode - 6 transport mode
Hydrostatic wheel motors- front and rear	Sauer-Danfoss (51 series) 80cc
Final drives	
Type	Planetary gear reduction hubs - front and rear..... Wheel Drive 606 19.66:1 w/brake
Lubrication.....	Oil bath

Brakes (parking only)

Type.....	Four wheel Multiple disc Spring applied Hydraulically released
-----------	--

Steering System

Type.....	Hydraulic, dedicated circuit
Control	Full-time power
Steering cylinders.....	Self-centering, double action

III. SPECIFICATIONS

AUXILIARY HYDRAULIC SYSTEM

Type Single closed center pump

Pump type..... Load sense

SPRAY SYSTEM

Booms

Type Wet, with variable row spacing

Standard 100 ft. (5 spray sections)

Controls Electro-hydraulic: fold/lift/level

Level shock absorber..... Gas-charged accumulator

Outer boom tip hydraulic breakaway..... Self-actuated, auto-reset hydraulic

Solution Fill Connection

Quick-fill connection (male with adapter for female) 3 in. (7.6 cm) I.D.

Solution Tank

Standard 2000 gal. (7570 l) stainless steel w/sight gauge

Agitation..... Sparge type with electronic
variable speed control

General Spray System

Pump..... Centrifugal - hydraulically driven with
pulse modulated control valve

Solution valves..... Electric ball valves

Pressure gauge 100 PSI glycerin filled

Console..... Raven 4600 (GPS-ready)

III. SPECIFICATIONS

ELECTRICAL SYSTEM

General Electrical System

Battery	Dual 12V, negative ground
Alternator	160 AMP, voltage regulated
Starter	12V with solenoid

Circuit Breakers/Fuses

Engine Box	(3) 7.5 Amp fuses
	(2) 10 Amp fuses
	(1) 20 Amp fuse
	(1) 40 Amp/12V micro relay
	(2) 125 Amp/32VDC
	(2) 12V SPDT micro relay
	(1) 100 Amp buss circuit breaker
Deluge Tank Harness.....	40 Amp relay VF4
MDM	150 VDC/ 100 Amp contactor relay
Flasher Relay	12 V flasher solid state
	(4) 15 Amp fuse
	(3) 40 Amp relay VF4
Fuse/Relay Harness	
Relay Module 1	(6) 12V diode micro relay
Relay Module 2	(3) 12V diode micro relay
Fuse Module 1	(1) 3 Amp fuse
	(4) 5 Amp fuses
	(4) 10 Amp fuses
	(7) 15 Amp fuses
	(2) 20 Amp fuses
	(1) 25 Amp fuse
Fuse Module 2.....	(1) 5 Amp fuse
	(4) 10 Amp fuses
	(6) 15 Amp fuses
	(6) 20 Amp fuses
Main Rear Harness	(1) 30 Amp fuse

III. SPECIFICATIONS

Lights

Cab Exterior

Front of cab	4 trapezoidal field lights and 2 head lights
Warning	2 SAFTI amber strobe lights 12VDC
Cab interior	1 LED courtesy, 1 dome
System indicators	1 red, 1 green

Booms

Boom light assembly	4
Solution valve indicator light assembly	(2) amber, (5) red lights
Transom mount	2 trapezoidal head lights, 2 amber trapezoidal
Boom cradle (forward)	2 trapezoidal work lights (1 each)
Boom cradle (rearward)	2 trapezoidal work lights (1 each)
Boom cradle (rearward)	2 amber trapezoidal work lights (1 each)
Rear exterior	2 round red, 2 round amber

CAB AND INSTRUMENTS

Cab

General cab	Tilt steering Windshield wiper/washer Heated side mirrors Dome light Tinted glass Training seat
Temperature control	Full-range
A/C charge type	R-134a
Fresh air filtration	Paper and charcoal filter
Seat	Air ride

Instruments

MDM	Hour meter Fuel Water temperature Battery voltage Engine oil pressure Ground speed Engine RPM
-----------	---

III. SPECIFICATIONS

TIRES

Tires (front and rear)

Standard	14.00 R 25 3*(Radial TU)
Air pressure	116 PSI (800 kpa)
Tire width	14.7in. (373 mm)
Load capacity at 25 MPH (40.2 Km/H)	13600 lbs. (6169 kg)
Overall diameter	55.5 in. (1410 mm)
Static load radius (suggested—will vary with load)	24.6 in. (625 mm)
Rolling circumference	166.97in. (4241 mm)

CAPACITIES

Solution tank.....	2000 gallons (7570ℓ)
Fuel cell	150 gallons (530 ℓ)
Cooling system (including block, lines & radiator).....	18 gallons (68 ℓ)
Hydraulic oil	52 gallons (170 ℓ)
Deluge washer stainless steel tank.....	36 gallons (136 ℓ)
Engine oil (including crankcase, lines, filter & cooler)	17 quarts (16 ℓ)

Wheel hubs

Front (2)	40 oz. (1.18 ℓ) each (approx.)
Rear (2)	40 oz. (1.18 ℓ) each (approx.)

III. SPECIFICATIONS

This page intentionally left blank

IV. OPERATING SYSTEMS

A. CAB

Front Console

- | | |
|---|----------------------------------|
| A. Hazard/ Warning light switch | F. Ignition switch |
| B. Highway lights, running light switch | G. Steering wheel tilt adjust |
| C. Steering Wheel | H. Steering column release pedal |
| D. Turn signal indicator light | |
| E. Turn signal switch | |

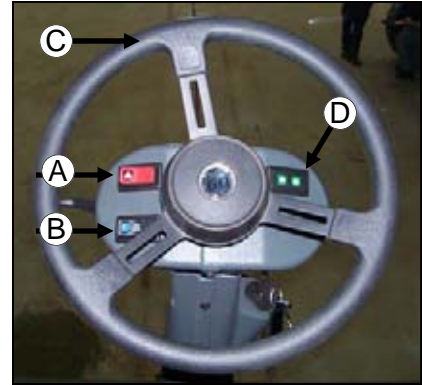

FIG. 4.21-1

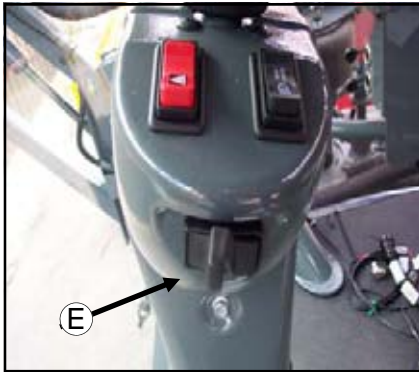

FIG. 4.21-2



FIG. 4.21-4



FIG. 4.21-3

HAZARD/ WARNING LIGHTS—To activate the flashing hazard/ warning lights (fig. 4.21-5 through 4.21-9) depress the “FLASHER” switch (fig. 4.21-1, item A). Activate the hazard/ warning lights anytime, day or night, that you are traveling on a public road unless prohibited by law.



FIG. 4.21-5



FIG. 4.21-6



FIG. 4.21-7



FIG. 4.21-8



FIG. 4.21-9

IV. OPERATING SYSTEMS

A. CAB

HIGHWAY LIGHTS/RUNNING LIGHTS– The highway lights are mounted on the cab and the either side of the transom (fig. 4.2A-1). Use these trapezoid head lamps when traveling on a public road at night. Turn them on using the highway/running light switch located on the front console (fig. 4.21-1, item B).

Activating the highway lights will also turn on the “red” running lights on the rear of the machine (fig. 4.22-2).

The ignition key does not have to be on to operate these lights.



FIG. 4.22-2



FIG. 4.22-1

TURN SIGNALS– To activate the front turn signals (fig. 4.22-3) and the rear turn signals (fig. 4.22-4 and 5), move the turn signal lever (fig. 4.21-2, item E) forward, away from the operator, to signal a right turn and back, toward the operator, to signal a left turn. Steering column– mounted turn signal indicators will correspondingly flash when either turn signal is activated. The turn signal switch is not a self– centering switch; you must return it to the “OFF” position by hand after completing your turn.



FIG. 4.22-3



FIG. 4.22-4



FIG. 4.22-5

IV. OPERATING SYSTEMS

A. CAB



FIG. 4.23-1

IGNITION SWITCH– The ignition switch has three positions. The first position is the “OFF” position. The second position is referred to throughout this manual as “ON”, the second position is “START”. To engage the starter, turn the key to the “START” position and hold momentarily until the engine engages. If the engine does not engage after 15 seconds, turn the key to “OFF”. Constant cranking of the starter when an engine fails to engage will cause damage to the battery and the starting system. Refer to OPERATING SYSTEMS section B on hydrostatic drive for more information.

TILT ADJUST HANDLE- The steering wheel tilt adjust handle is for the movement of the upper portion of the steering column only. The steering wheel has infinite position possibilities.

To use the adjustment handle turn it down (toward the operator) to loosen it. You do not need to remove the handle all the way, simply loosen it enough to freely move the steering wheel.

With the handle loosened, push or pull on the steering wheel until it is in a comfortable position. Hold the steering wheel in that position while tightening the adjustment handle. To tighten the adjustment handle turn it upward (away from the operator).



FIG. 4.23-2

NOTE:

Be sure the steering wheel and column are locked in place before trying to move the machine. Failure to do so will make it difficult to maintain control of the machine.

STEERING COLUMN RELEASE PEDAL– The steering column release pedal is for easy exit/ easy entry of the cab. Push the pedal to release the locking gas spring. With the gas spring released, you can smoothly move the entire steering column forward or backward.

To lock the column in place, simply remove your foot from the pedal while holding the column in place. Once the gas spring has locked again, check the column by firmly trying to move the column in either direction.

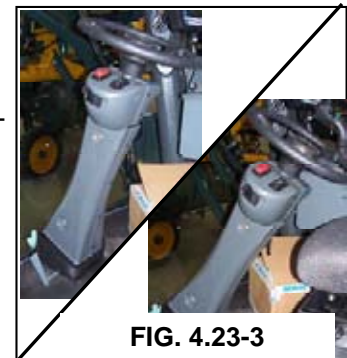

FIG. 4.23-3

IV. OPERATING SYSTEMS

A. CAB

Side Console

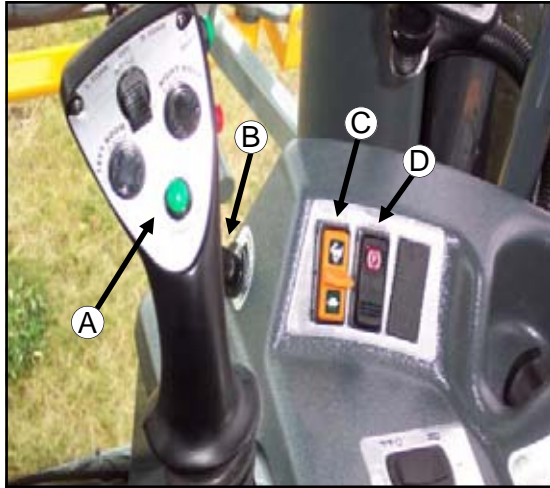

FIG. 4.24-1

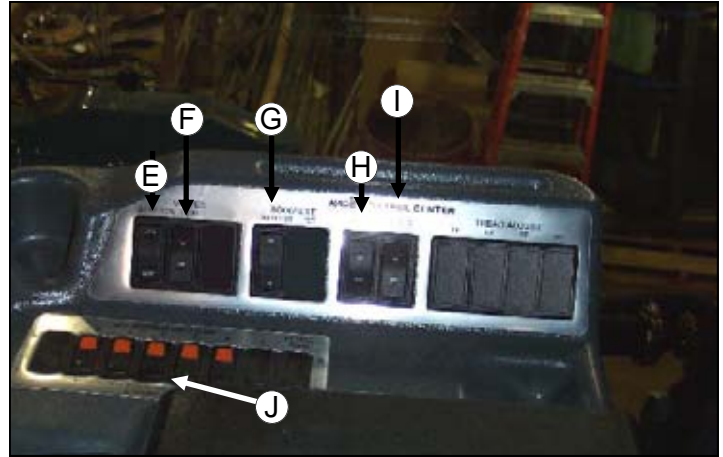

FIG. 4.24-2

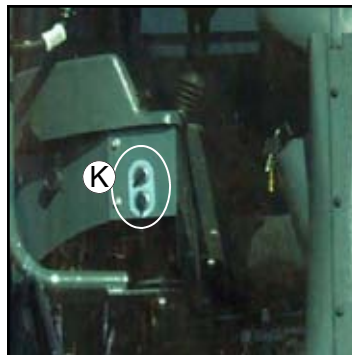

FIG. 4.24-4

- A. Hydrostatic Lever
- B. Brush Control
- C. Throttle switch
- D. Brake/Ladder switch
- E. Agitation switch
- F. Solution Tank switch
- G. Boom Extension switch
- H. Float switch
- I. Work Mode switch
- J. Boom Spray Section switches
- K. Power Ports

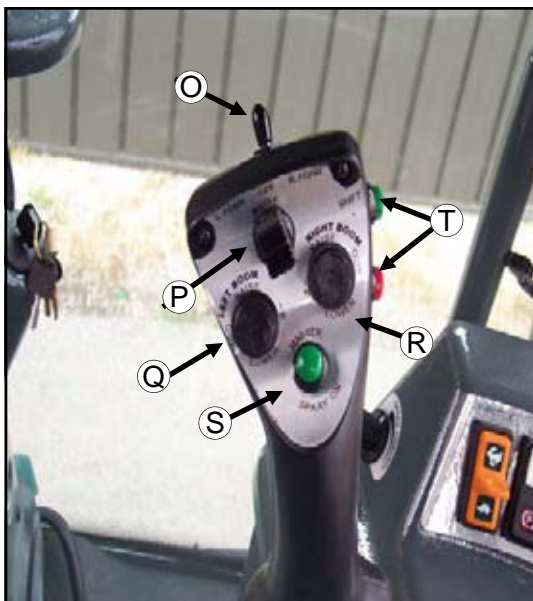

FIG. 4.24-3

- L. Forward
- M. Neutral/Stop
- N. Reverse
- O. Foamer switch
- P. Hydraulic Lift*
- Q. Left Boom (level, horizontal fold)*
- R. Right Boom (level, horizontal fold)*
- S. Master Spray switch "ON"*
- T. Speed Range switch*

(items marked with a * have different functions when used in FLOAT mode)
Refer to attachment section, or attachment manual for instruction.

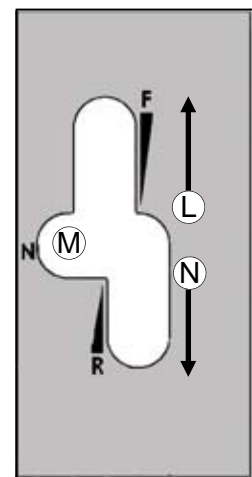

FIG. 4.24-5

IV. OPERATING SYSTEMS



FIG. 4.25-1

HYDROSTATIC LEVER– The hydrostatic lever is used to control the direction of motion of the machine and the speed at which it travels. It is a part of the ACE hydrostatic drive system or the Automatically Controlled Engine Hydrostatic Drive. To learn more about the ACE system, refer to the OPERATING SYSTEMS section B on the hydrostatic drive system.

The lever also houses controls for the spray system and plow functions. For information on the spray controls, refer to OPERATING SYSTEMS section D on the spray system. For more information on the plow functions refer to the plow manual.

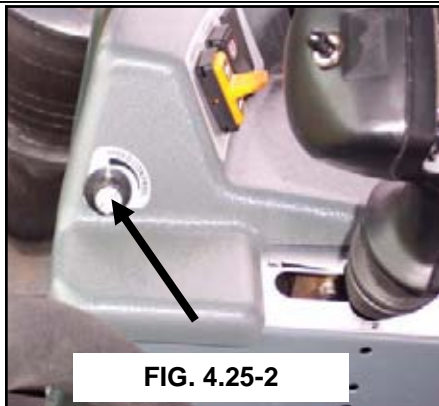

FIG. 4.25-2

BRUSH CONTROL- The brush control dial is used to control the speed that the brushes are turning. The dial is only functional when the FLOAT and WORK MODE switches on the side console are on and the MAIN SPRAY CONTROL/ BRUSH CONTROL switch on the hydrostatic lever is activated.

Turn the dial away from the operator (counterclockwise) to increase the speed of the brushes. Turn the dial toward the operator (clockwise) to reduce the brush speed.

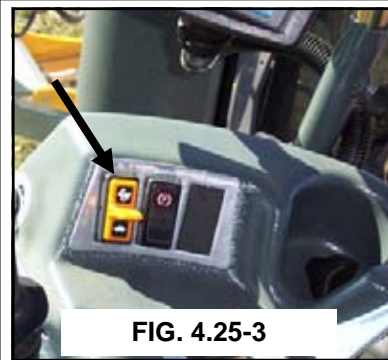

FIG. 4.25-3

THROTTLE SWITCH- The throttle switch (fig. 4.5A-3) is used to control engine RPM. There are 2 settings that are controlled by the switch, high and low, with a RPM range of 800 to 2500.

The buttons on the side of the hydrostatic lever (fig. 4.5A-4) are to control the speed ranges within the RPM setting. For more information on the throttle controls,



FIG. 4.25-4

refer to OPERATING SYSTEMS section B on the hydrostatic drive system.



FIG. 4.25-5

PARKING BRAKE- The parking brake switch is located next to the throttle switch on the side console. The switch also controls the ladder. The brake switch must be on to lower the ladder and to run the side fill or pressure washer (if equipped).

The parking brake is not intended for normal or emergency stopping and will not engage if machine is moving over 1 mile per hour. Activating the brake while the machine is still moving is hazardous to the operator and the sprayer. Bring the sprayer to a complete stop with the hydrostatic lever in the neutral position before applying the parking brake.

IV. OPERATING SYSTEMS

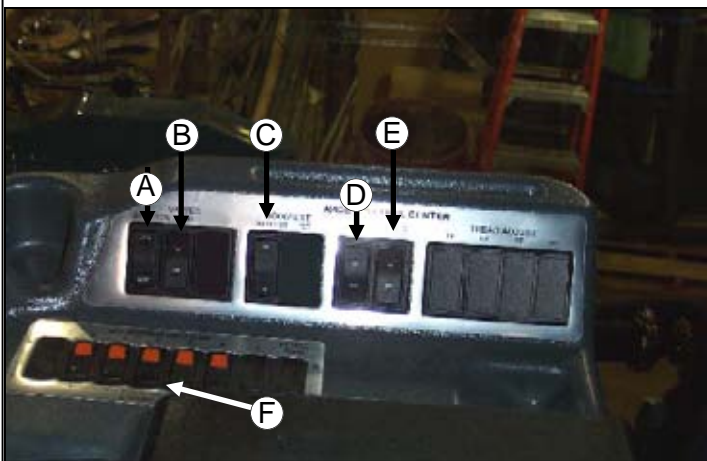

FIG. 4.26-1

AGITATION SWITCH- The agitation switch (fig. 4.26-1, item A) controls the rate of flow through the sparge system. For more information on the agitation system, refer to OPERATING SYSTEMS section D on the Spray Systems.

TANK SWITCH- The tank switch (fig. 4.26-1, item B) controls the solution tank valve. This switch must be on to spray. For more information on the tank switch, refer to OPERATING SYSTEMS section D on the spray system.

BOOM EXTENSION SWITCH- Boom extension (fig. 4.26-1, item D) switches are used when folding and unfolding the booms. Refer to OPERATING SYSTEMS section C on spray booms.

FLOAT SWITCH- The float switch is used with the plow functions. It allows the free movement of the plow and the brushes. Refer to the plow manual for greater detail about the plow functions.

WORK MODE SWITCH- The work mode switch (fig. 4.26-1, item F) is a safety switch. There are systems connected to this switch that will not function if the switch is not ON and this switch can not be turned on if certain conditions exist. You can not turn the switch on if the machine is not in neutral. The switch controls the functions of the spray system and the booms. This was set up to protect you and others from accidentally engaging the spray system while transporting. Be sure that this switch is on before you intend to engage the spray system.

BOOM SOLUTION VALVE SWITCH- The boom solution valve switches (fig. 4.26-1, item I) each control a valve located on the transom and the booms. The valves control the flow of solution through the boom. The boom is broken down into 5 sections, the far left tip being the beginning of section one. See section D under OPERATING SYSTEMS on the spray system for more information.

IV. OPERATING SYSTEMS

A. CAB

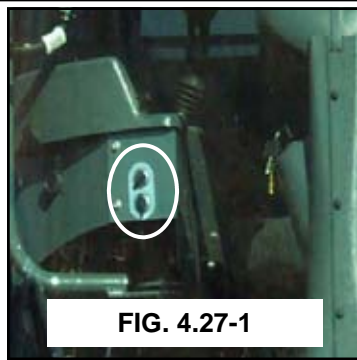

POWER PORTS- On the front of the side console there are two power ports (fig. 4.27-1) for extra equipment to be plugged in. They are each protected by a 15 amp fuse. They are not intended for the permanent connection of extra systems to the sprayer. There is a terminal strip intended for the installation of extra radios and computer equipment. See the SERVICE section E on the electrical components. Top port is 12V all the time and bottom port is powered by key.

FOAMER SWITCH- The foamer switch on the top of the hydrostatic lever (fig. 4.27.2, item A) controls the foam option on either side of the machine. This option is not available on the GST 20 machines.

MAIN SOLUTION SWITCH- The main spray control (fig. 4.27-2, item E) in the lower middle of the hydrostatic lever is so the operator can turn all spray valves off at one time. See OPERATING SYSTEMS section D on spray systems for more information. This switch is also used for the

brushes on the plow, refer to the plow manual for more information.



FORWARD CONTROL- The hydrostatic lever is responsible for the direction of motion of the machine. To move forward, slowly move the hydrostatic lever forward. (fig. 4.27-2, item F)

REVERSE CONTROL- To move the machine in reverse, slowly move the hydrostatic lever backward. (fig. 4.27-2, item H) Be sure that the machine is clear of all dangers before putting it in reverse.

NEUTRAL POSITION- The neutral position is also the stop or brake position. (fig. 4.27-2, item G) The neutral position must be met before changing direction of the machine. There are several functions that can not be performed if the machine is not in the neutral position.

More information on the forward, reverse, and neutral positions of the hydrostatic lever is available in section B of the OPERATING SYSTEMS.

ITEMS.

LIFT, LEVEL, HORIZONTAL FOLD- (fig. 4.27-2, items B, C, & D) are all a part of the hydraulic system. A complete explanation of their functions can be found in section C of the OPERATING SYSTEMS. Refer to the plow manual for information about their plow operation functions.

IV. OPERATING SYSTEMS

A. CAB

Overhead Controls and Monitors

- A. Hagie diagnostic port
- B. Warning Indicator Light
- C. Spray System Indicator Light
- D. MDM
- E. Wiper switch
- F. Washer Fluid switch
- G. Field Lights switch
- H. Work Lights switch
- I. Mirror switch
- J. Climate Control– fan
- K. Climate Control– temp
- L. Raven Console
- M. Plow Control decal
- N. Vents

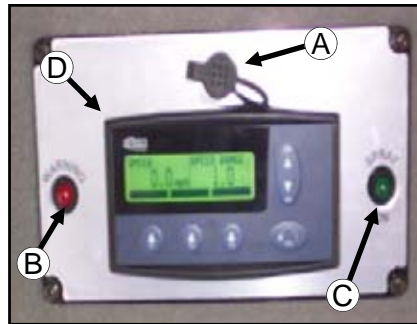

FIG. 4.28-1

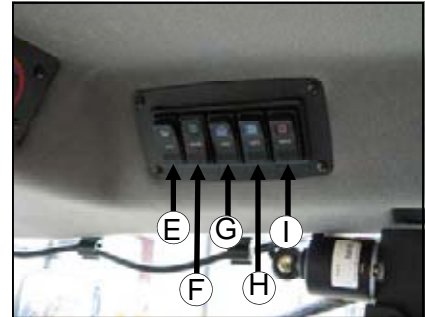

FIG. 4.28-2

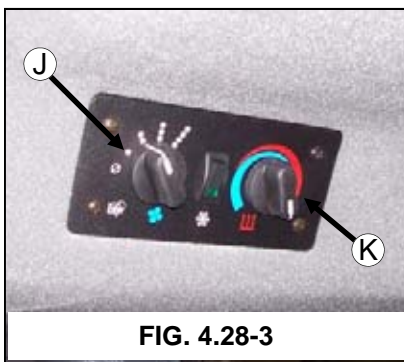

FIG. 4.28-3



FIG. 4.28-4

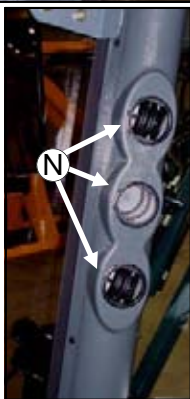

FIG. 4.28-6

HAGIE DIAGNOSTIC PORT– The Hagie diagnostic port (fig. 4.28-1, item A) is used for diagnostic purposes only. The Hagie Customer Service department can hook into your system to gather information on faults and malfunctions of the machine. From this port, they would also be able to reprogram the machine if it became necessary. This port is not for the use of personal computers or personal digital assistants (PDA's).

The Hagie diagnostic port is protected by a 10 amp fuse.

WARNING INDICATOR LIGHT– The warning indicator light (fig. 4.28-1, item B) will come on if there are any malfunctions or faults in the systems monitored by the MDM. These warnings include, but are not limited to: engine oil pressure, oil level, hydraulic oil level, coolant temperature, battery voltage, and fuel level. An explanation of the fault will appear on the screen. If a fault appears, shut engine off immediately and resolve the fault before continuing. Failure to do so may result in damage to the system with the detected fault.

IV. OPERATING SYSTEMS

A. CAB

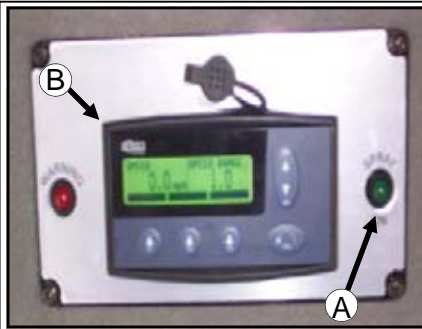

FIG. 4.29-1

SPRAY SYSTEM INDICATOR LIGHT– The spray system indicator light (fig. 4.29-1, item A) will illuminate when the main spray control on the hydrostatic lever (fig. 4.29-2) has been activated. If the light is not on, the spray system is not on. This light will also illuminate when using the plow brushes.



FIG. 4.29-2

MDM– The MDM (fig. 4.29-1, item B) is also referred to as the message center. The MDM takes the place of the conventional gauges. The MDM can give you information on tread adjust width, engine RPM, engine oil pressure, hour meter, fuel level, coolant temperature, tire size, battery voltage, speed range, and machine program version. The information can be viewed by using the up and down arrows to move through it. The MDM will also display any faults found in the monitored systems.

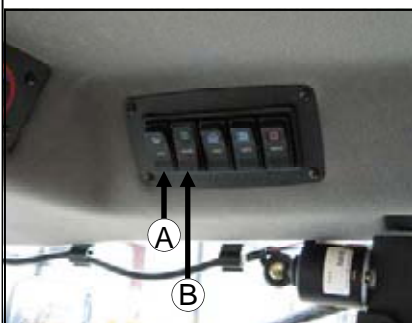

FIG. 4.29-3

WINDSHIELD WIPER AND WASHER FLUID SWITCHES– The windshield wiper switch (fig. 4.29-3, item A) located on the right side of the headliner, turns on the wipers (fig. 4.29-5 and 6). The wiper will continue to operate until the switch is returned to the OFF position.

To activate the deluge system pump, press the washer fluid switch (fig. 4.29-3, item B) and hold until the desired amount of fluid is dispensed and then re-

lease the switch. You must turn the wiper OFF when the washer fluid has been completely wiped away. The deluge tank is located behind the solution tank (fig. 4.29-4).

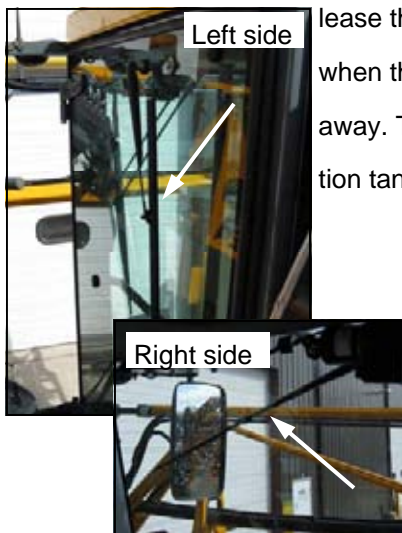

FIG. 4.29-6



FIG. 4.29-5



FIG. 4.29-4

IV. OPERATING SYSTEMS

A. CAB

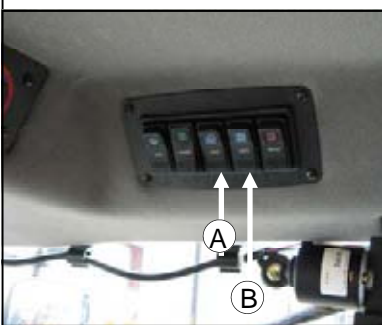

FIG. 4.30-1

FIELD LIGHTS AND WORK LIGHTS–

The field lights (fig. 4.30-2), located on the front of the cab with the headlights, are activated by pushing the switch located on the upper right cab headliner (fig. 4.30-1, item A). Use these lights when operating in the field after dark.



FIG. 4.30-2

Turn them off before entering a public roadway.



FIG. 4.30-3

The work lights (fig. 4.30-3), located on each boom cradle, one facing forward and one facing backward, are activated by pressing the other switch located on the right upper cab headliner. These lights can also be used when operating in the field after dark. Turn them off before entering a public roadway.

The ignition key has to be on to operate these sets of lights, but extended use without the engine operating to charge the battery is not recommended.

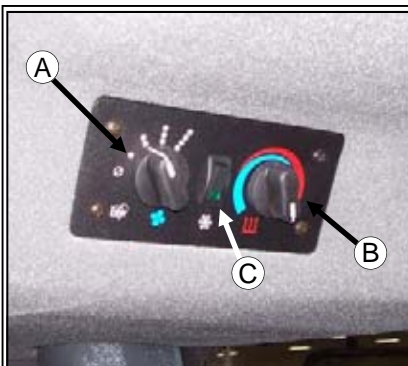

FIG. 4.30-4

CLIMATE CONTROLS -

The climate controls (fig. 4.30-4) are continuous adjusting dial switches located on the front upper cab headliner.

Adjusting Fan Blower Speed– fan blower speed is controlled by the left rotary dial (fig. 4.30-4, item A). To increase the fan speed, rotate the dial clockwise. To reduce the fan speed, rotate the dial counterclockwise. To shut the fan off, rotate the dial all the way counterclockwise.

Adjusting Temperature Setting– forced air temperature adjustments are controlled by the right rotary dial (fig. 4.30-4, item B). Temperature control is a continuously variable adjustment. To increase the forced air temperature, rotate the dial clockwise. To decrease the forced air temperature, rotate the dial counterclockwise.

Operating the Air Conditioning– to activate the air conditioner, press the air conditioning switch (fig. 4.30-4, item C). Adjust fan speed and temperature accordingly. See section B under SERVICE for servicing information.

IV. OPERATING SYSTEMS

A. CAB



FIG. 4.31-1

HEATED MIRRORS– The mirrors are heated for easy de-icing. To activate the mirror heat, depress the top of the switch. To turn the heat off, depress the bottom of the switch (fig. 4.31-1).



FIG. 4.31-2



FIG. 4.31-3

VENTS– There are 6 adjustable vents, 3 on each front cab corner post (fig. 4.31-3). They may be adjusted by rotating them for desired direction, or individually turned on or off with the directional fins.



FIG. 4.31-4

RAVEN SPRAY SYSTEMS CONSOLE– The spray system is controlled by the Raven SCS 4600 (fig. 4.31-4, item A) and the Pulse Width Modulated Valve (fig. 4.31-5). The system receives data and automatically makes adjustments based on the target rate of application set by the operator.

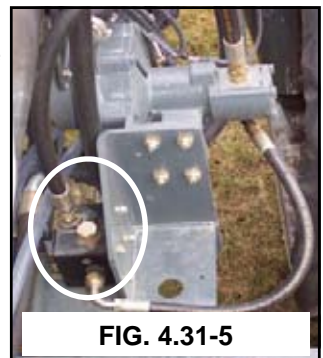

FIG. 4.31-5

For detailed information regarding the programming and operating of the Raven console system, please refer to the manufacturer's installation and operation manual.

The decal for the plow controls (fig. 4.31-4, item B) is located to the right of the Raven console. The buttons are located on the hydrostatic lever. Refer to the plow manual for their functions.

IV. OPERATING SYSTEMS

A. CAB

Other Features

- A. Res-Q-Me Tool/ Emergency Exit
- B. Cab Glass
- C. Buddy Seat
- D. Cab Fresh Air Filters
- E. Interior Lights
- F. Air-Ride Seat



FIG. 4.32-1

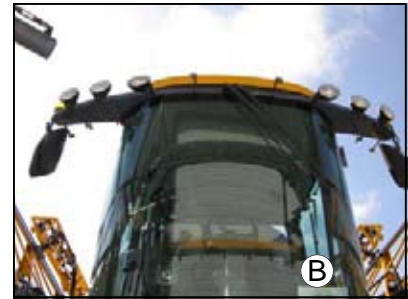

FIG. 4.32-2



FIG. 4.32-3

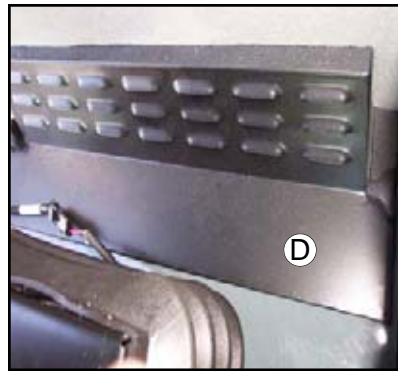

FIG. 4.32-4



FIG. 4.32-5



FIG. 4.32-6

INTERIOR LIGHTS— The GST cab has two interior lights. A dome light that comes on when the door of the cab is opened, and a courtesy light that comes on when the field lights are turned on. (fig. 4.32-5)The courtesy light illuminates the side console. The dome light can be turned on manually.

IV. OPERATING SYSTEMS

A. CAB

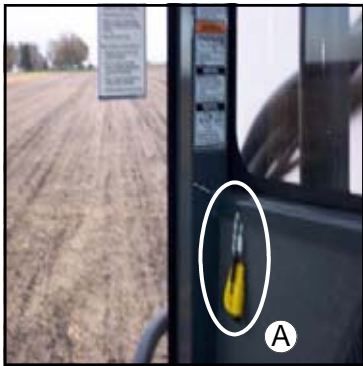

FIG. 4.33-1

RES-Q-ME TOOL/ EMERGENCY EXIT– The RES-Q-ME tool (fig. 4.33-1) located on the right rear cab frame, is used for an emergency exit. The device, when firmly pressed against any glass in the cab, will automatically trigger shattering the glass. Do not look directly at the glass as you use the tool.

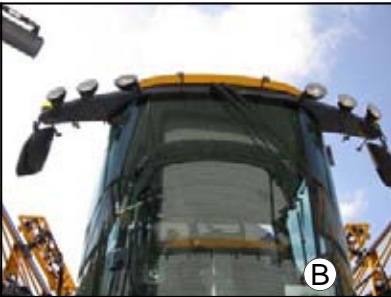

FIG. 4.33-2

CAB GLASS– The glass of the cab is DOT approved tempered glass. The front windshield is rounded with a green UV reflective tint and the side and back panels are flat with a UV reflective gray tint.

The design of the cab and the use of the glass allows a 210° view, tip to tip of the booms from the operator's seat.



FIG. 4.33-3

CAB FILTERS– Inside the cab are two filters (fig. 4.33-3), a charcoal filter and a paper filter. Refer to the SERVICE section B on filters for maintenance information. Refer to the Hagie GST20 Part Manual for replacement part information.

IV. OPERATING SYSTEMS



FIG. 4.34-1

BUDDY SEAT– The buddy seat (fig. 4.34-1) was designed as an instructional tool. It is specifically designed for a “co-pilot” to be seated in a good position to be taught how to use the sprayer.

The buddy seat has a hinged seat that lifts to reveal a storage compartment. Do not use the compartment to store chemical soaked clothing or gloves.

AIR RIDE SEAT

- A. **Seat Cushion Adjustment:** Rotate knob to desired cushion position
- B. **Height Adjustment:** Pull knob out to lower seat. Push knob in to raise seat.
- C. **Lateral Isolator:** Lift lever to engage lateral isolator. Push lever down for lock-out.
- D. **Ride Firmness Adjustment:** Rotate knob counterclockwise for firm ride; clockwise for soft ride; and in the middle for an average ride.
- E. **Fore-Aft Adjustment:** Pull lever out and move seat.
- F. **Fore-Aft Isolator:** Lift lever to engage fore-aft isolator. Push lever down for lock-out.
- G. **Backrest Adjustment:** Lift lever to stop and lean rearward or forward to adjust backrest position.
- H. **Armrest Tilt Adjustment:** Turn counterclockwise to lower tilt; clockwise to raise tilt.
- I. **Lumbar Adjustment:** Rotate knob clockwise to increase lumbar support; counterclockwise to decrease support.

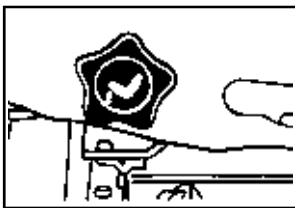

A



B

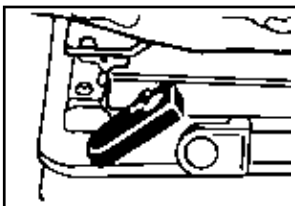

C

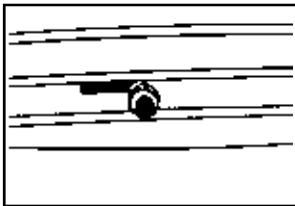

D

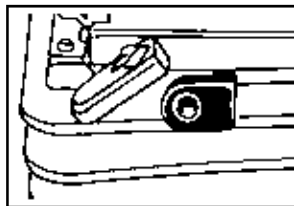

E

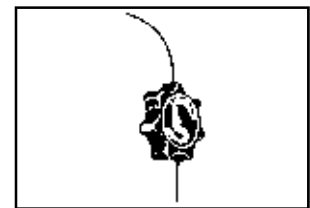

F

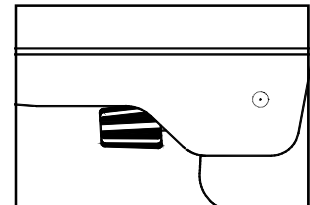

H

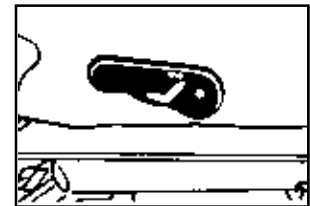

G



F

IV. OPERATING SYSTEMS

B. HYDROSTATIC DRIVE SYSTEM



FIG. 4.35-1

- A. Cummins Engine
- B. Tandem Hydrostatic Pumps
 - Series 90 for drive system (left)
 - H1 pump for flail ONLY (right)
- C. Front and Rear Wheel Motors
- D. Wheel Hubs



FIG. 4.35-2



FIG. 4.35-3

CUMMINS ENGINE AND TANDEM PUMP– The GST comes standard with a 275hp Cummins diesel engine (fig. 4.35-1). The engine has a dual direct-mounted Sauer-Danfoss 90 Series tandem hydrostatic pump (fig. 4.35-2). More information on the operation of the engine is on the next page. The engine is equipped with an automatic exhaust brake.

WHEEL MOTORS AND WHEEL HUBS–The GST's all-time four wheel drive system consists of the Sauer-Danfoss hydrostatic wheel motors (fig. 4.35-3) and the planetary gear reduction hubs (wheel hubs) (fig. 4.35-4).

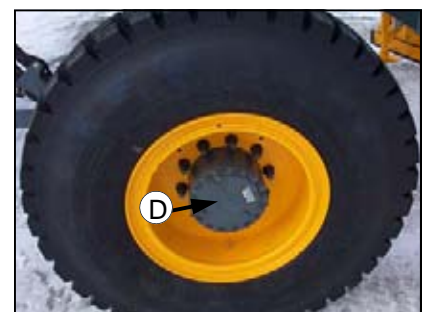

FIG. 4.35-4

IV. OPERATING SYSTEMS

B. HYDROSTATIC DRIVE SYSTEM

Operating The Engine



CAUTION

Start engine from operator's seat only. When running engine in a building, be sure there is adequate ventilation.



Pre-operational Checks	Section Reference
1. Check the engine oil level. Do not operate when oil is below the low mark on the dipstick.	83
2. Check the coolant level in the radiator and the coolant overflow reservoir.	85
3. Check the hydraulic oil reservoir level.	83
4. Check the cooling air intake screen	88
5. Check the Filter Minder®.	87
6. Drain fuel/water separator.	89
7. Check engine drive belt.	94
8. Drain any water out of the air tank daily.	100
9. Check for any oil or fuel leaks and correct them if needed.	

NOTE:
Cold oil may not flow in quantities adequate to prevent pump cavitation.



FIG. 4.36-1

BATTERY DISCONNECT- The GST is set up with a battery disconnect safety device (fig. 4.36-1). This device is located on the left side of the rear frame cross tube. When the key is turned to the OFF position the electrical circuit is broken therefore rendering the machine unable to start. Do not use this device as a safety when working on the electrical system— disconnect the negative battery cable before servicing.

This device is also used as an anti-theft safeguard. Keep the key in a safe place, out of the machine when it is not in use.

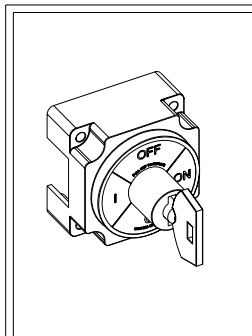

IMPORTANT

Do not use disconnect to stop engine. Do not bypass disconnect. Do not terminate electrical devices to battery terminals. Disconnect negative before servicing electrical equipment. Completely isolate electronics before welding. Key must be inserted and rotated to "ON" position for operation.

660372

IV. OPERATING SYSTEMS

B. HYDROSTATIC DRIVE SYSTEM

STARTING THE ENGINE-

1. Position the hydrostatic control lever to "N" (neutral) position (fig. 4.37-1).
2. Put the parking brake switch (fig. 4.37-2) to the ON position (see below). Turn the ignition key switch to the ON position, wait for the "wait to start" light in the MDM (fig. 4.37-3) to go out before engaging the starter. If the engine fails to start after 15 seconds, turn the key to OFF, wait one minute and repeat the procedure. If the engine does not start in three attempts, check the fuel supply system. Absence of blue or white exhaust smoke during cranking indicates that no fuel is being delivered.
3. Observe the warning lights on the message center after start up. If any functions do not operate, shut off engine and determine the cause.
4. Always allow at least a five minute warm-up period before operating the engine at high RPM. This means that the engine must reach operating temperature and oil pressure must stabilize in the normal operating range before it is run faster than an idle (1000 RPM).

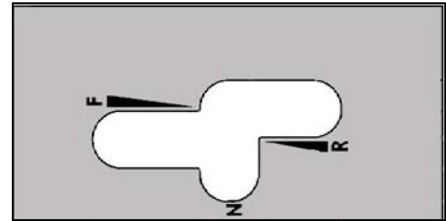

FIG. 4.37-1



FIG. 4.37-2



FIG. 4.37-3

PARKING BRAKE- The parking brake will engage if the charge pressure falls below 150 PSI or the engine is shut off. To engage the brakes manually, press the top of the PARKING BRAKE/LADDER switch (fig. 4.37-2) located on the side console.

To disengage the brakes, press the bottom of the switch.

Always turn the brakes off before moving the GST.

The brake switch must be engaged to lower the ladder and to run the side-fill or pressure washer. The ladder will automatically lower when brake switch is pressed.

NOTE:

The parking brake will not engage over 1 mile per hour.



CAUTION

Activating the brake switch while the machine is moving is potentially hazardous to the operator and the machine.

IV. OPERATING SYSTEMS

B. HYDROSTATIC DRIVE SYSTEM

COLD WEATHER START-UP PROCEDURE-

NOTE:
Auxiliary hydraulic functions may be limited until the tank temperature comes up to operating temperature.

If the Low Hydraulic Oil Temperature warning occurs, please use the following start-up procedure:

With the Spray Boom attached:

Once the tank temperature reaches 50°F, increase the engine RPM to high idle. Move the machine into an open area where the booms can be unfolded and stop.

1. Un-cradle and completely fold the booms, at the horizontal extension, one at a time.
2. Raise and lower the boom three times.
3. One at a time, raise the boom completely and raise and lower each boom level three times.
4. Lower the booms and fold and unfold the boom, at the vertical extension. from 60' to 100' three times.
5. Raise and fold the booms back and set them in the cradles.
6. Start the machine moving forward slowly (3 MPH max.) and turn left and right (lock to lock) 3 times.
7. Check the hydraulic tank temperature, if it is above 80° the machine is ready to be used.

IV. OPERATING SYSTEMS

B. HYDROSTATIC DRIVE SYSTEM

With the Edge Light Plow attached:

Increase the engine RPM to high idle. Move the machine into a safe area and stop.

1. Turn the work mode switch to ON and float switch to OFF.
2. Turn the speed control knob backwards completely.
3. Press the Green button on the hydrostatic lever to activate the brushes.
4. Slowly turn the speed control knob forward until the brushes start to turn.
5. Raise and lower the plow three times.
6. Raise the plow completely, raise and lower the plow tip three times.
7. Open and close the plow doors completely three times.
8. Slowly increase the speed of the brushes.
9. Start the machine moving forward slowly (3 MPH Max) and turn left and right (lock to lock) 3 times.



IV. OPERATING SYSTEMS

B. HYDROSTATIC DRIVE SYSTEM

ACE: AUTOMATICALLY CONTROLLED ENGINE-

1. Speed ranges are selected by a red (decrease speed range) and green (increase speed range) electronic switch mounted on the hydrostatic lever (fig. 4.40-1, item A). The lower the setting, the higher the torque, but the lower the speed.
2. Increase the engine one bump to gain RPM of 1800 with the throttle switch (fig. 4.40-2). More RPM will be gained as you move the hydrostatic lever forward.
3. To move forward, slowly push the hydrostatic lever forward. The farther the control lever is moved, the faster the GST will travel and the RPM 's will increase (fig. 4.40-3). To stop, slowly pull the lever to the "N" neutral position.
4. To reverse the machine, slowly pull the hydrostatic lever back. To stop, slowly push the lever to the "N" neutral position.
5. Before turning off the engine, reduce engine speed and allow the engine to idle at least three minutes.

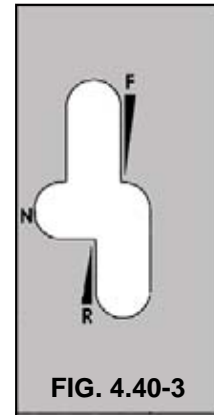
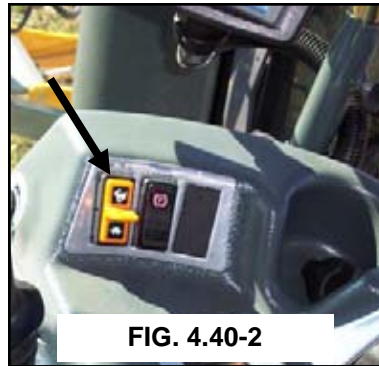
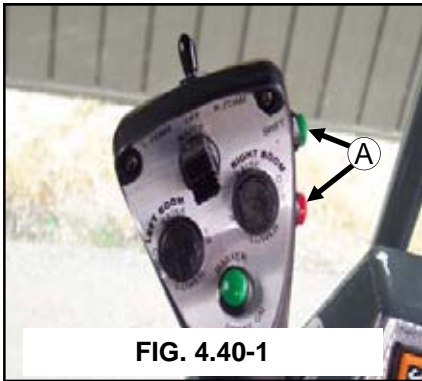

NOTE:

Machine will not shift down until highest speed of desired range is met.

IV. OPERATING SYSTEMS

C. HYDRAULIC SYSTEM



FIG. 4.41-1

- A. Hydraulic Pump
- B. Power Steering
- C. Solution Pump
- D. Ladder
- E. Spray Booms



FIG. 4.41-2

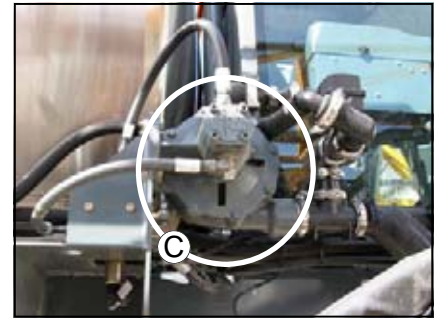

FIG. 4.41-3



FIG. 4.41-4



FIG. 4.41-5



The **AUXILIARY HYDRAULIC SYSTEM** is a load sensing, pressure compensated system with efficiency in mind. That means it only pumps the amount of oil needed to do the job.

The pump is mounted to the “front” of the second hydrostatic pump (fig. 4.41-1). The systems consist of a single variable displacement pump that supplies the required hydraulics to operate the full time power steering unit, boom control cylinders (lift, level, and fold), ladder, outer boom breakaway, and the solution pump.

The return oil from the load sense pump is mixed with the oil from the gear pump on the side of the engine. This pump supplies a constant flow of oil from the hydraulic tank to the cooler and then back to the tank through the filter. This is considered a kidney loop and is dedicated to the cooling and filtration of the hydraulic system.

The hydraulic lines that connect the attachment to the machine’s hydraulic supply are equipped with a quick coupler system. This system allows for easy removal and attaching of the booms or other attachment.

IV. OPERATING SYSTEMS

C. HYDRAULIC SYSTEM

HYDRAULIC PUMPS– The hydraulic pumps (fig. 4.42-1, item A) circulates the hydraulic oil throughout the necessary systems and back through a cooler before returning it to the reservoir.

If the level in the reservoir drops too low to safely operate the machine you must shut down the engine immediately to prevent damage to the hydraulic system.



FIG. 4.42-1

POWER STEERING SYSTEM– The power steering is a dedicated circuit steering system with full time

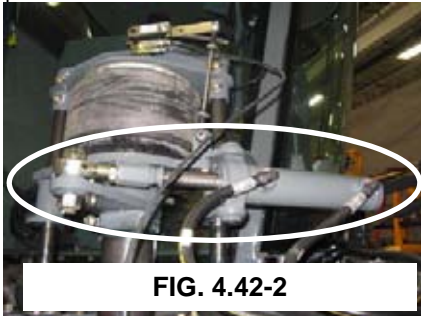

FIG. 4.42-2

SOLUTION PUMP– The solution pump is a centrifugal pump controlled hydraulically with the pulse width modulated control valve. The valve is controlled by the Raven console per the calibration settings entered by the operator.



FIG. 4.42-3

BRUSH SPEED CONTROL– The rate of rotation by the brushes may be adjusted with the speed control dial (fig. 4.42-4). This will conveniently help to adjust the speed of the brushes to accommodate any situation.

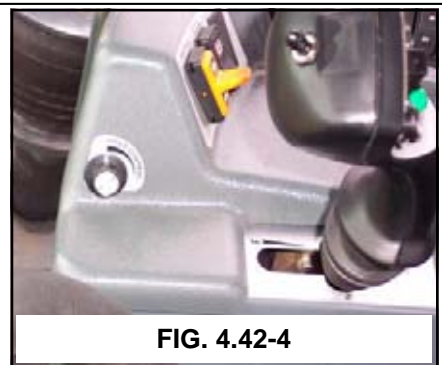

FIG. 4.42-4

IV. OPERATING SYSTEMS

C. HYDRAULIC SYSTEM

 **CAUTION**

Upright ladder is not a service platform or step. **DO NOT** step on the ladder while in upright position. **DO NOT** lower ladder while anyone is on the ground near the GST. **DO NOT** attempt to lower ladder from the ground level, ladder may swing quickly and strike an unsuspecting person.



LADDER- To raise or lower the ladder you will need to locate the BRAKE/LADDER switch at the front of the right hand console (fig. 4.43-3). When the brake is applied the ladder will lower automatically (fig. 4.43-1). The ladder will not raise (fig. 4.43-2) until the machine is running and the switch has been returned to the OFF position.



 **CAUTION**

**DON'T RISK INJURY BY
SLIPPING OR FALLING
BE CAREFUL**

WATCH YOUR STEP

650848

IV. OPERATING SYSTEMS

C. HYDRAULIC SYSTEM

SPRAY BOOMS– Hydraulically folding the extension of the 60/100 foot boom system and adjusting spray valves essentially turns it into a 60 foot boom. (continue reading this section for more information)

The spray booms are controlled by an electro-hydraulic system. This system consists of operator manipulated switches located in the GST's cab and hydraulic cylinders attached to the booms. It provides control of lift, level, horizontal extension, and vertical extension.

All GST spray booms are equipped with a hydraulic breakaway circuit. When folded out as a 100 foot spray boom, a one-way hydraulic circuit on the outer boom section provides outer boom breakaway functions. The outer breakaway is self-resetting and will return to normal operating position after it has cleared the hazard (fig. 4.44-1).



FIG. 4.44-1

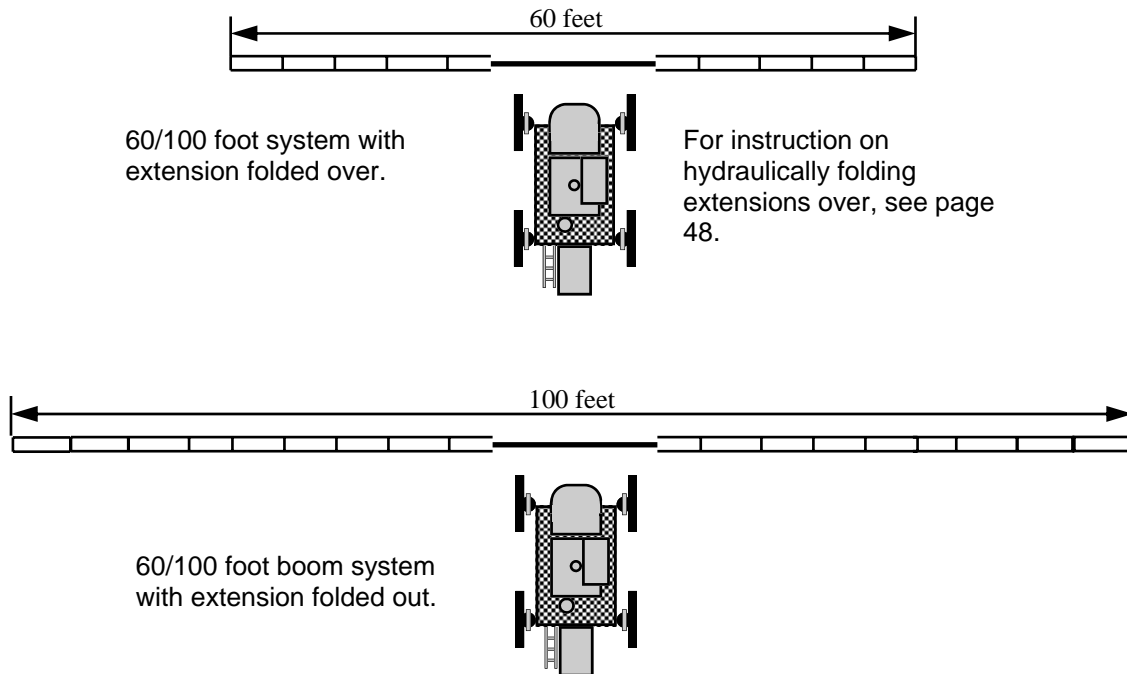

IV. OPERATING SYSTEMS

C. HYDRAULIC SYSTEM

Lift

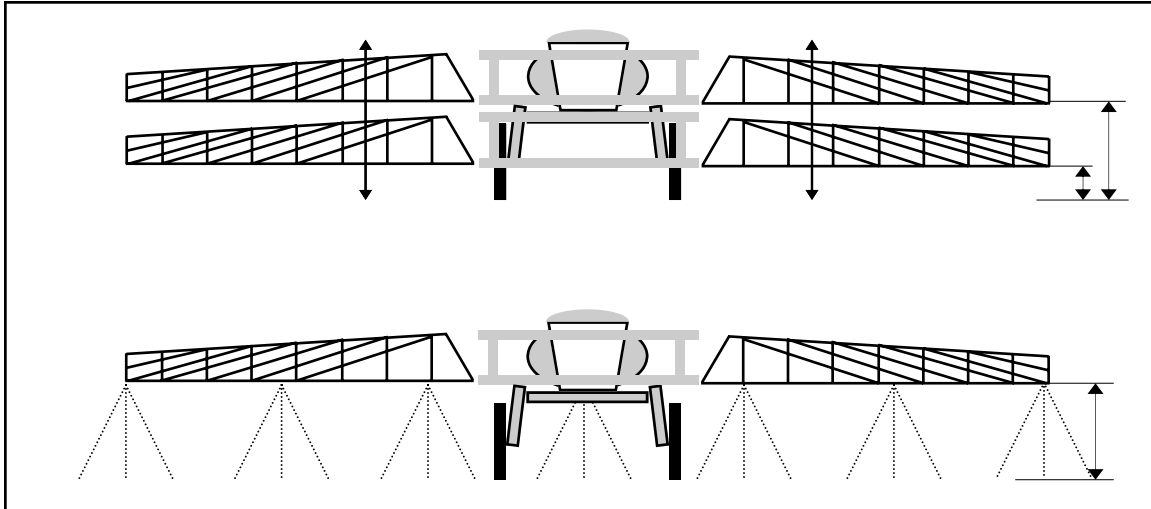

FIG. 4.45-3

NOTE:

See your spray tip manufacturer's guide for information regarding spray tip height (fig. 4.45-3).



FIG. 4.45-1

To raise and lower the transom/boom assembly, depress the "square rocker" on the hydrostatic lever (fig. 4.45-1) and move it either UP or DOWN. While pressed, it will activate the transom lift cylinders (fig. 4.45-2).



FIG. 4.45-2

IV. OPERATING SYSTEMS

C. HYDRAULIC SYSTEM

Level

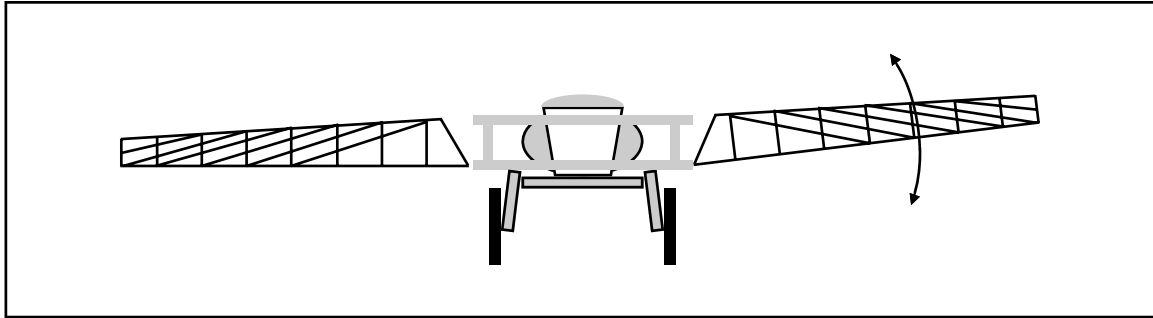

FIG. 4.46-1

To increase or decrease the angle of each individual boom level, depress the left or right “Round Rocker” UP or the left or right “Round Rocker” DOWN buttons on the hydrostatic lever (fig. 4.46-3). While depressed, these buttons activate the level cylinders connecting either boom to the transom (fig. 4.46-2).

This adjustment also aids in placing the booms correctly in the cradles for transporting and storing.



FIG. 4.46-2



FIG. 4.46-3

IV. OPERATING SYSTEMS

C. HYDRAULIC SYSTEM

Horizontal Boom Extension

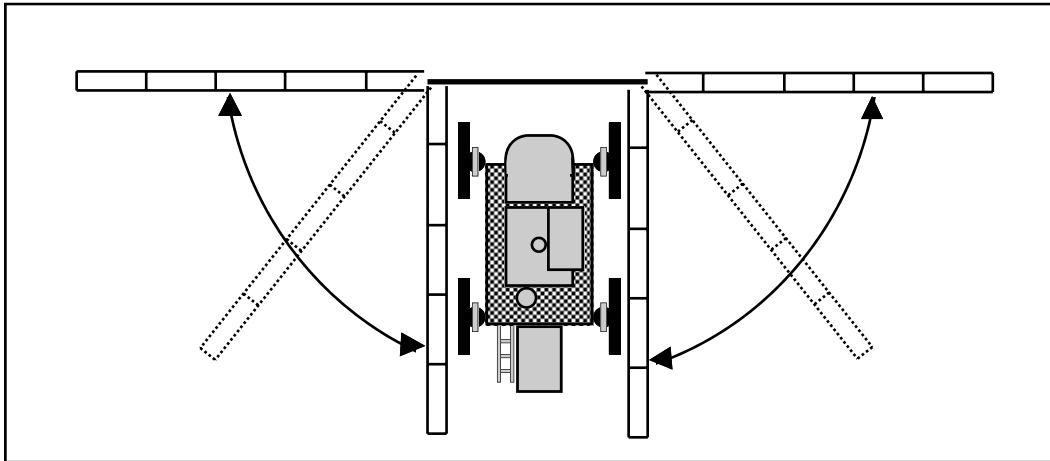

FIG. 4.47-1

HORIZONTAL BOOM EXTENSION - To fold either boom horizontally in toward the machine or out, depress the right or left Rocker "Boom Fold" switches on the hydrostatic lever (fig. 4.47-3). While depressed, these switches activate cylinders connecting either boom to the transom (fig. 4.47-2).

Fold or unfold the booms in an open area only. Make sure no one is standing in the boom fold's travel path. Booms can be folded if speed is less than 5MPH.



FIG 4.47-2



FIG 4.47-3

IV. OPERATING SYSTEMS

C. HYDRAULIC SYSTEM

Vertical Extension

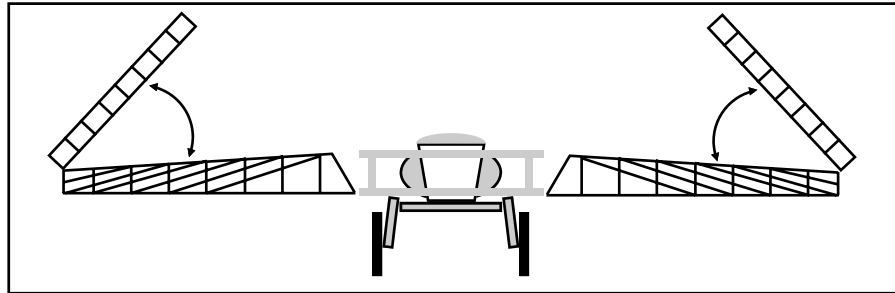
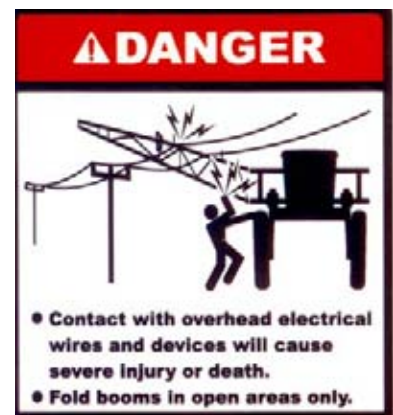

FIG. 4.48-1

NOTE:

Boom extensions can only be folded when hydrostatic control lever is in the neutral position, and you have pushed the **F1** or **ok** in the message center showing you have acknowledged there are no power lines overhead. If GST is put in gear during folding, booms will stop.



VERTICAL EXTENSION - To extend the boom folds vertically in or out, depress the top or bottom of the **Boom Extension** switch (fig. 4.48-2). **This activates BOTH vertical extension cylinders connecting the inner boom section and the center boom section (fig. 4.48-3).**

Fold or unfold the booms in an open area only. Make sure there are no overhead obstructions or wires to interfere with extension folding. The booms will vertically unfold even if they are still in the boom cradle or are not horizontally extended!

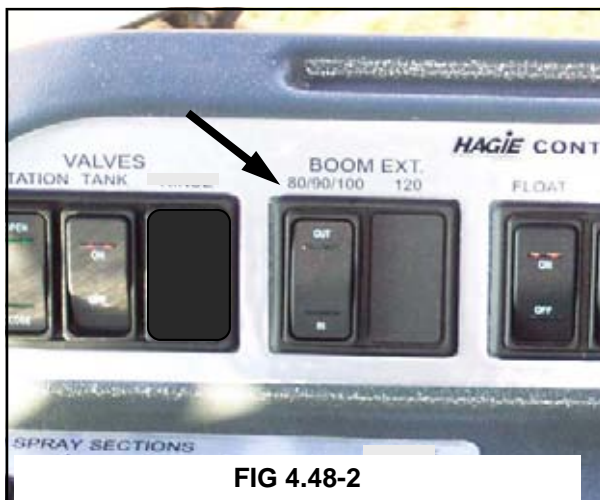

FIG 4.48-2



FIG. 4.48-3

IV. OPERATING SYSTEMS

This page intentionally left blank

IV. OPERATING SYSTEMS

D. SPRAY SYSTEM

Introduction



The spraying system is a constantly monitored and continuously adjusted computer controlled system. The cab mounted digital console receives information from various inputs to help determine GPM (gallons per minute) and GPA (gallons per acre).

In the following section, the components of the spray system will be explained. Please read the entire section before operating the GST's spray system. This section is not designed to replace the Raven manual, the numbers may not reflect your specific situation. Read all manuals before operating this equipment.

Instructions

OPERATION

PAGE REFERENCE

1. Calibrate spray system console. 64-74 or Raven manual
2. Check contents and quantity in solution tank.

NOTE:

Never attempt to operate the spray system without solution in the spray tank. Operating the spray system with no solution in the tank will cause severe damage and void the warranty.

3. Start engine. 37-39
4. Open tank valves, if desired, activate the agitation system. 52, 53
5. Turn on the WORK MODE switch. 26
6. Turn on the main spray power. 55
7. Place individual boom solution valve switches to the ON position. 55
8. Slowly move the hydrostatic lever forward to obtain the desired ground speed. 40
9. Frequently observe the pressure gauge. When it drops to zero, or spray pattern deteriorates, shut off main spray power, solution pump, and agitation system until refilling solution. 53

IV. OPERATING SYSTEMS

D. SPRAY SYSTEM

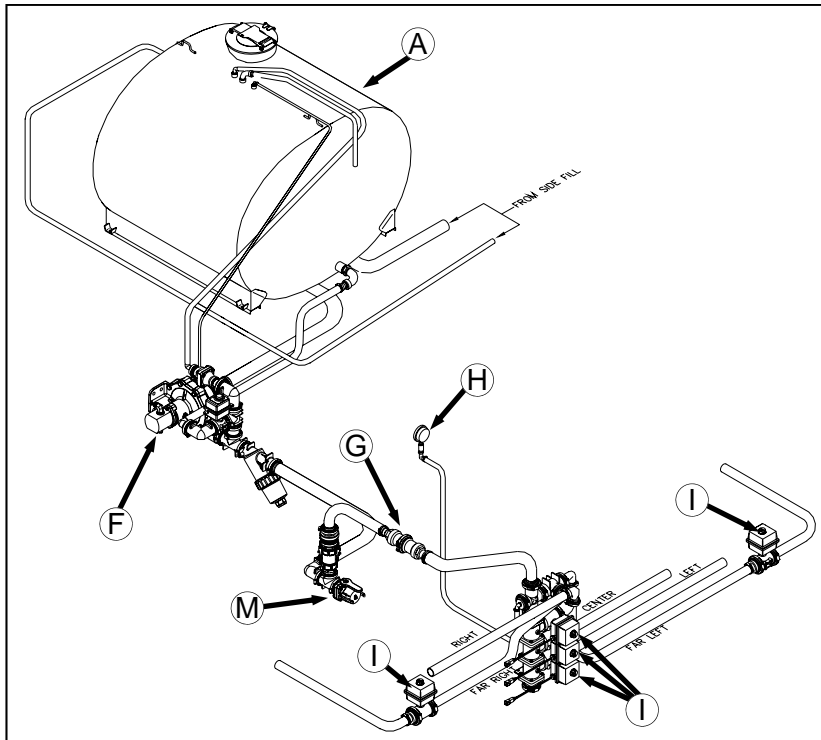

FIG. 4.51-1

- | | |
|-------------------------------|---------------------------------------|
| A. 2000g Stainless Steel Tank | I. Individual Solution Control Valves |
| B. Side fill Connection | J. Agitation Switch |
| C. Solution Tank Valve | K. Individual Spray Control Switches |
| D. Sump Valve | L. Main Solution Spray Control Switch |
| E. Solution Tank Valve Switch | M. Solution Quick Connect |
| F. Solution Pump | |
| G. Flow Meter | |
| H. Pressure Gauge | |

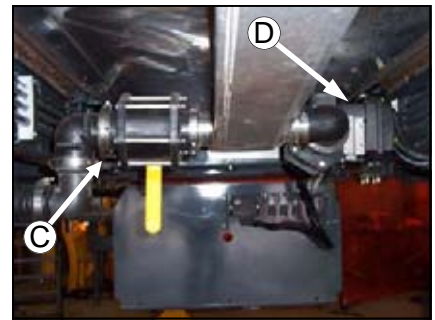

FIG 4.51-2

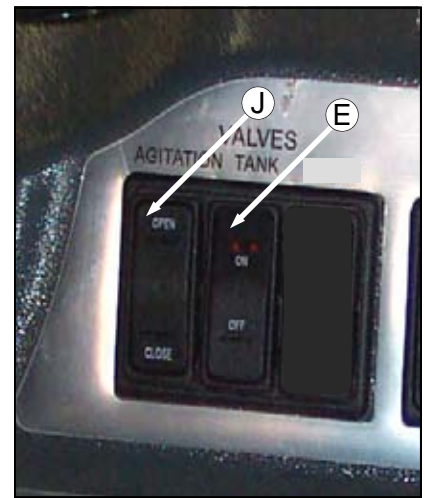

FIG 4.51-3



FIG. 4.51-4

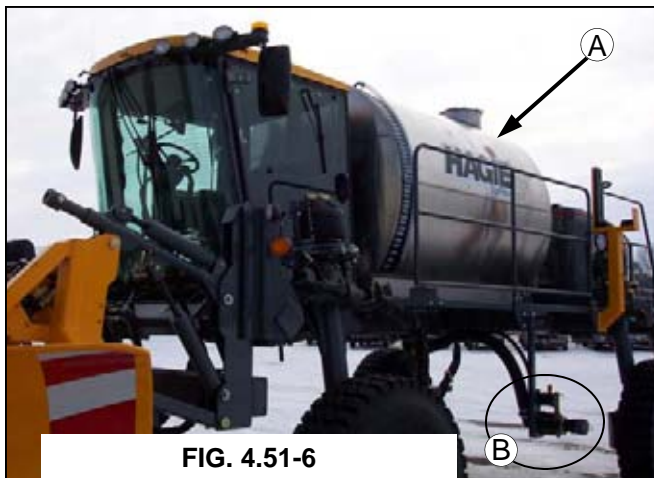

FIG. 4.51-6



FIG. 4.51-5

IV. OPERATING SYSTEMS

D. SPRAY SYSTEMS

SOLUTION TANK– The GST has a 2000 gallon capacity stainless steel solution tank (fig. 4.52-1). The stainless steel tank has a sparge type agitation system.



SOLUTION TANK VALVE– The solution tank valve (fig. 4.52-2, item 1) controls the amount of solution coming out of the tank. The valve is controlled from inside the cab with the TANK VALVE switch (fig. 4.52-3) located on the right hand console.

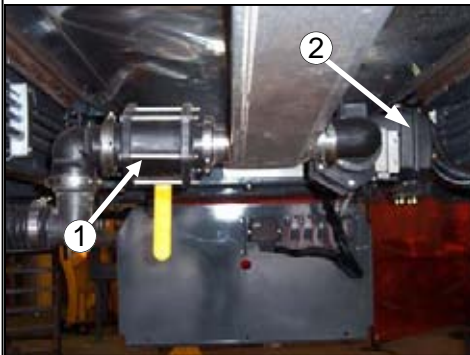

TANK SUMP VALVE– The tank sump valve (fig. 4.52-2, item 2) is a ball type valve that has to be turned on and off manually.

This valve is to allow the fluid into the tank from the side fill.

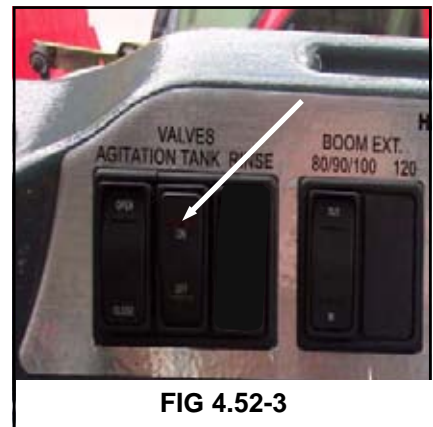

SOLUTION PUMP– The solution pump (fig. 4.52-4) is a centrifugal type hydraulic pump that is controlled by the Pulse Width Modulated Valve (fig. 4.52-5) and the Raven console (fig. 4.52-6). The pump draws the solution out of the tank at a rate determined during the calibration of the Raven console. It dispenses it through the many valves and hoses that make up the spray system. The pump also dispenses fluids through the agitation system and the rinse systems.



IV. OPERATING SYSTEMS

D. SPRAY SYSTEMS

SOLUTION PRESSURE GAUGE– The pressure gauge (fig. 4.53-1) gives the operator a constant visual display of the amount of solution being applied (measured in PSI). The pressure, as determined by the pulse width modulated control valve, will vary according to ground speed. If applying solution manually, the solution pressure gauge visually informs the operator of needed manual adjustments. The gauge also shows when there is a drop in pressure indicating that the solution tank maybe empty or there is a problem with the system.



FIG. 4.53-1

FLOW METER– The flow meter located in the main solution line (fig. 4.53-2) monitors the solution flow and sends information back to the console and control valve. If the flow rate is not within the parameters programmed, the control valve will compensate by either opening or closing. If the rate continues to be outside the parameters an alarm will sound signaling a low flow rate. (See the Raven Console guide for more information on low flow limit)

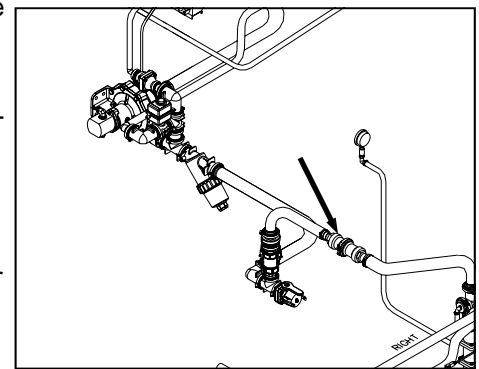

FIG. 4.53-2

AGITATION– The speed of the sparge agitation system of the stainless steel tank is controlled by a variable flow solution valve (fig. 4.53-3, item 1) mounted on the solution pump (fig. 4.53-3, item 2). The agitation switch (fig. 4.53-4) on the right hand console controls the rate of flow through the sparge system.

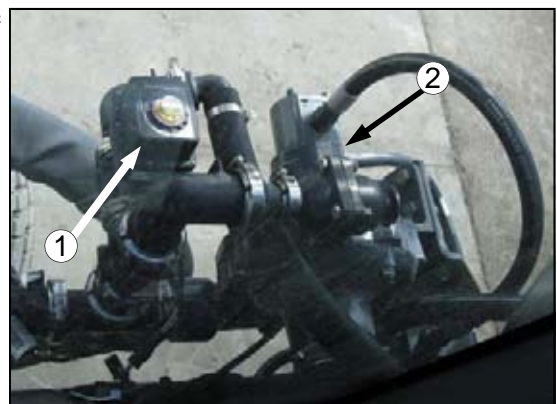

FIG. 4.53-3



FIG 4.53-4

While watching the indicator on the agitation valve, increase or decrease the flow rate with

the control switch. To increase the flow, press the switch up. To decrease the flow, press the switch down. When the desired rate of flow is achieved, release the switch.

To turn the agitation system off, decrease the flow rate all the way. The tank will not pump out completely if the agitation valve is left open.

IV. OPERATING SYSTEMS

D. SPRAY SYSTEMS

SIDE- FILL OPERATION– The solution tank is filled using an operator supplied loading source connected to the side-fill. The side-fill is stationary on the right side of the machine. The rinse connection is located directly above the solution fill connection.

To fill the solution tank, follow these steps:

1. Connect the loading supply to the side-fill connection.
2. Open the solution fill valve on the side-fill (fig. 4.54-2, item 1)
3. Open the sump valve under the tank (fig. 4.54-1, item 1)
4. Fill to the desired level not to exceed 2000 gallons.
5. Close both valves before disconnecting supply.
6. Replace cap to protect opening.

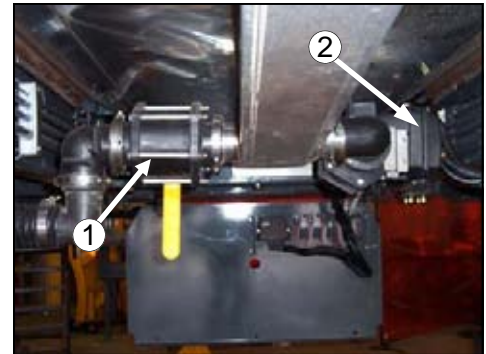

FIG 4.54-1

To rinse the tank and spray system, follow these steps:

1. Connect the source of fresh water.
2. Open the rinse connection valve (fig. 4.54-2, item 2).
3. Rinse the entire spray system, including the booms, by allowing the tank to fill to adequate rinse level and run the spray system as you would while spraying chemicals.



FIG 4.54-2

NOTE:

Follow all regulations regarding the disposal of waste chemicals and cleaning agents. Do not allow them to contaminate a water supply!

IV. OPERATING SYSTEMS

D. SPRAY SYSTEMS

BOOM SOLUTION VALVE SWITCHES– The spray booms are divided into sections that are independently supplied with solution and therefore can be shut off or turned on independently. The electronic boom solution valves are controlled by a row of switches mounted on the right hand console (fig. 4.55-1).



FIG. 4.55-1

Sixty foot boom configurations are divided into three sections and the valves are mounted on the transom. One hundred foot booms are divided into five sections with three of the valves mounted on the transom and one mounted on each boom.

BOOM SOLUTION VALVE L.E.D. INDICATORS– Boom solution valve status is displayed on the transom by a series of L.E.D. indicators (fig. 4.55-2). Each indicator light will illuminate if that particular boom solution valve is turned OFF.



FIG 4.55-2



FIG. 4.55-3

MAIN SOLUTION SWITCH– Main spray power can be controlled from a switch on the hydrostatic lever (fig. 4.55-3). This controls the panel of boom solution valve switches. The main switch must be on to supply the individual switches with voltage. This allows you to turn all of the boom solution valves ON or OFF at the same time such as turning it off when you arrive at the end of the row and turning it back on after you turn around. The individual switches allow you to turn the valves on or off separately.

When the main spray power is ON a green indicator light mounted

on the right side of the message center (fig. 4.55-4) will illuminate and a white indicator light mounted on the transom

assembly (fig. 4.55-5) will illuminate also.



FIG. 4.55-4

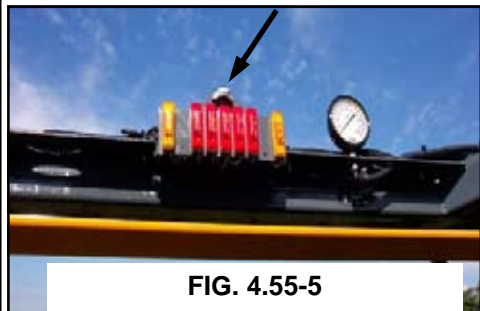

FIG. 4.55-5

NOTE:

DO NOT allow the pump to keep running when the boom switches are turned off. Failure to do so will generate in over-heating and cause severe pump damage and void the warranty.

IV. OPERATING SYSTEMS

E. OPERATING THE QUICK-ATTACH SYSTEM

DETACHING BOOM FROM THE MACHINE



FIG. 4.56-1

FOLLOW THESE STEPS:	PAGE AND FIGURE REFERENCE
1. Determine where to place the boom once it is off the machine.	57
2. Lower the boom and secure the boom stands in the down position.	58
3. With the booms folded, horizontally extend the booms so that the folded tip is approximately even with the rear of the cab.	59; FIGURE 4.59-1
4. Disengage the quick attach lock assemblies.	59; FIGURE 4.59-2
5. Slowly and gently lower the boom and transom assembly until the quick attach hook is free of lock pin.	59; FIGURE 4.59-3
6. Make sure the solution valves are OFF and turn off the engine before disconnecting any hoses or electrical lines.	
7. Once you have cleared the lock pin, unhook the hydraulic, solution, electrical, and foamer lines (if equipped), being careful not to leave the ends in a place that they may get damaged or contaminated.	60; FIGURES 4.60-1 thru 4.60-4
8. If no other attachment is going to be installed, re-lock the quick attach lock assembly to keep it safe from damage. Be sure to unlock it again when installing an attachment.	
9. Start the machine and slowly back out and away from the boom. Alarms will sound notifying you of modules offline, accept the warnings.	

IV. OPERATING SYSTEMS

E. OPERATING THE QUICK-ATTACH SYSTEM



FIG. 4.57-1

WHERE TO STORE IT? - When looking for a place to store the boom, there are three important things to keep in mind.

First of all, is the ground level? The ground must be pretty level to help prevent tip over. Look at the ground in all directions. Level ground will also minimize stress on the frame of the attachment while in storage.

Second of all, is there enough space? The boom option has to be partially open in order for it to stand properly. Make sure that there is adequate room to allow for the boom.

If you are storing the boom in a building, make sure that you have adequate room around it to safely pass by.

Third, is it accessible? You want to make sure that you can get back into the boom and that you are not blocking anything.

If temporarily storing the boom on a soft surface, such as grass, you may want to put blocks under the stands' feet to prevent the attachment from sinking into the ground. It is not recommended that booms be stored on a soft surface for an extended period of time because of the risk of the soil settling even when blocks are used.

IV. OPERATING SYSTEMS

E. OPERATING THE QUICK-ATTACH SYSTEM

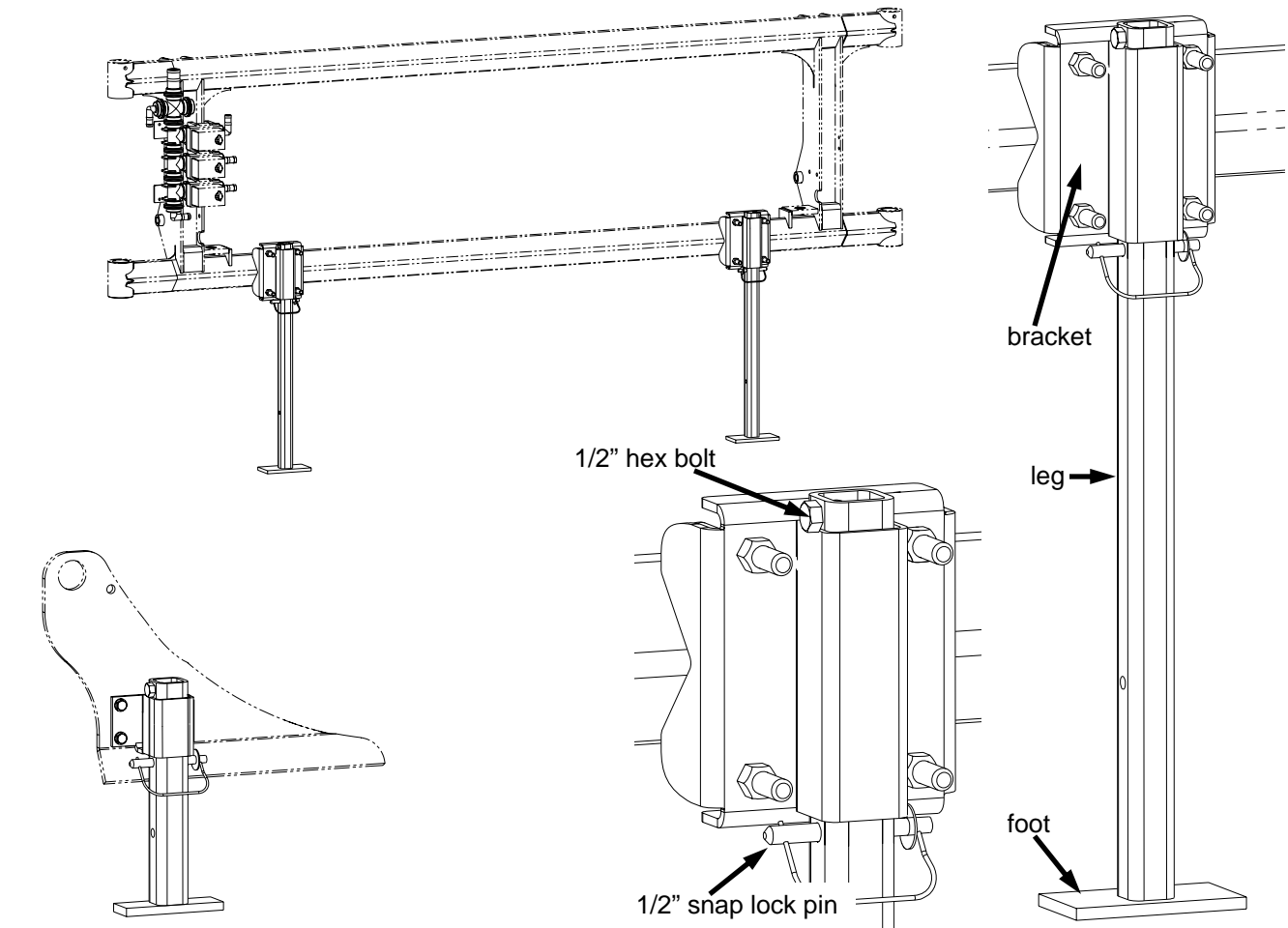

BOOM STANDS- If your boom option is equipped with boom stands, there are two on the transom and one on each of the inner sections of the booms. This is an option and not mandatory on every boom. Do not be alarmed if your boom does not have stands with it. Contact the Hagie Customer Service Department if you would like to have stands.

The stands are very simple. There are brackets attached to the end of the first boom section on both booms and two on the transom. Each has a leg with a foot on the bottom. Each has a hex bolt in the top hole of the leg to secure it from sliding off, and a snap lock pin in the hole directly below the bracket to maintain it's position.

Do not leave the stands in the lowered position at anytime while moving the boom. Damage may occur to the boom if the stand were to catch uneven ground or an unseen object. Raise the foot all the way up and place the pin in the hole above the bracket.

IV. OPERATING SYSTEMS

E. OPERATING THE QUICK-ATTACH SYSTEM

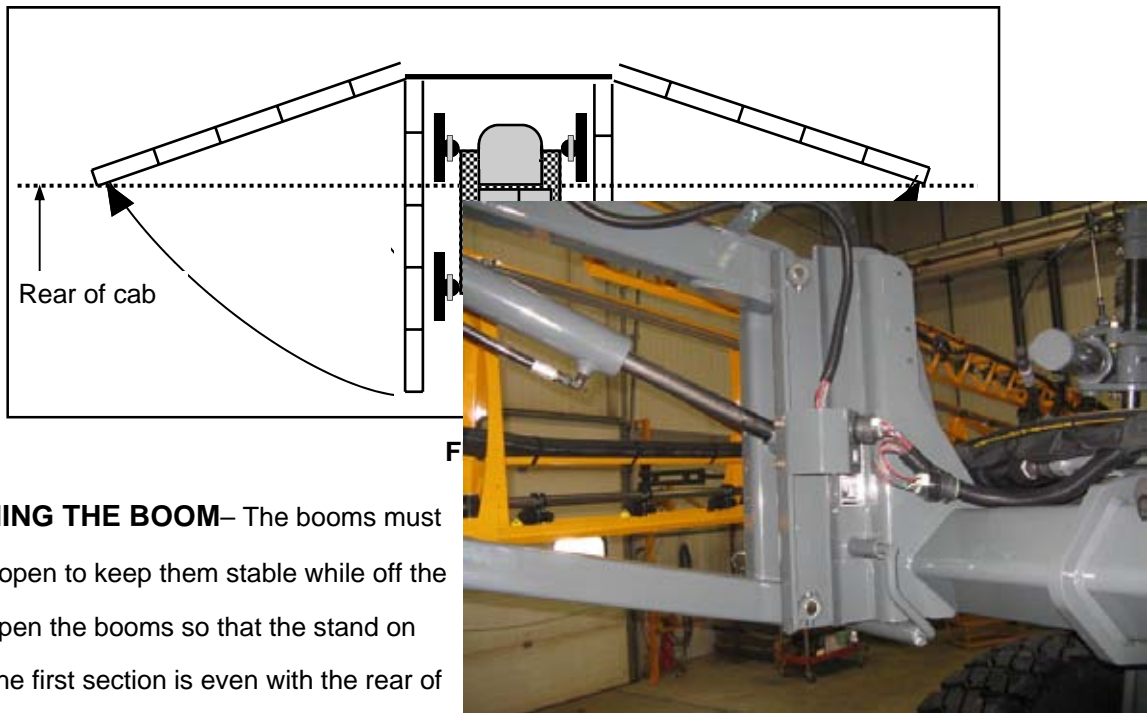

OPENING THE BOOM– The booms must be partially open to keep them stable while off the machine. Open the booms so that the stand on the end of the first section is even with the rear of the cab (fig. 4.59-1).



FIG. 4.59-2

DISENGAGE THE LOCK ASSEMBLY– Disengage the lock pin assembly only after you have lowered the boom close to the ground.

To disengage the lock assembly (fig. 4.59-2), pull the pin out as far as it will go. Once the pin is out as far as it will go, it should lock in the out position. Make sure that the lock assembly does not re-lock while you are trying to remove the boom.



FIG. 4.59-3

LOWER THE BOOM TO THE GROUND– Slowly and gently ease the boom to the ground. *Airbags may need to be dumped.

Use the boom level function to try and make sure that all four stands touch the ground at the same time. Continue to lower the boom until the quick attach hooks have cleared the lock pin. You may notice a “bounce back” effect when the weight of the boom has been relieved from the machine. Once the airbags have cycled, the machine will adjust to the new weight.

IV. OPERATING SYSTEMS

E. OPERATING THE QUICK-ATTACH SYSTEM

 WARNING Turn the engine OFF before disconnecting any hoses or electrical lines! Failure to do so may result in serious injury or death.

NOTE: Make sure the solution valves are OFF before disconnecting solution hoses!
--

DISCONNECT SOLUTION LINES, ELECTRICAL LINES, AND HYDRAULIC LINES– Once you



FIG. 4.60-1

have cleared the lock pin, you will have to disconnect anything that may be connecting the boom to the machine. This includes solution lines, electrical lines, and hydraulic lines.

Make sure that the solution valve is OFF. There will be a small amount of solution leak out. If it doesn't stop, or it is excessive, check the valve switch. If the switch is off, contact Hagie Customer Service for repair or parts.



FIG. 4.60-2

A standard GST machine will have 3 points of disconnection from the boom: the electrical pigtail on the front-right hand side of the machine (fig. 4.60-1), the hydraulic quick coupler in the center of the machine (fig. 4.60-2), and the main solution disconnect on the right side of the machine, above the front wheel (fig. 4.60-3).

Remember to use the caps that are provided for the hoses. If there is not a cap, cover the opening with a plastic bag secured with tape until you can get a replacement cap from Hagie Customer Service. (See Parts Manual)

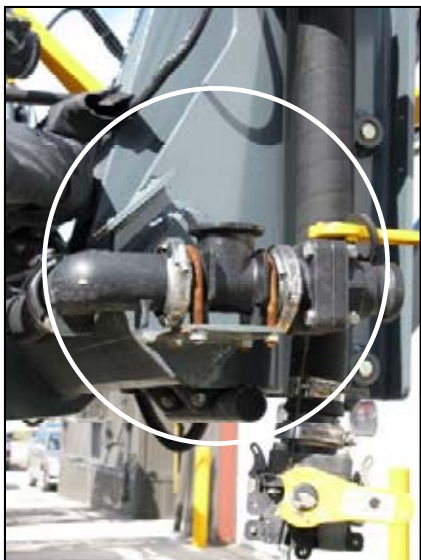

FIG. 4.60-3

Once you have disconnected everything, you may slowly back away from the boom. The lift arms will stay in their position because of an automatic block that holds the pressure in the lift cylinders.

IV. OPERATING SYSTEMS

E. OPERATING THE QUICK-ATTACH SYSTEM

CONNECTING BOOM TO THE MACHINE

FOLLOW THESE STEPS:	PAGE AND FIGURE REFERENCE
1. Square up to the boom. Make sure the quick attach lock assemblies are open.	62
2. Pull into the boom slowly .	62
3. Once you are pulled in squarely to the boom, dump airbags if needed and check to see that the quick attach hooks are high enough to go over the lock pins. If the hooks are high enough, no adjustments need to be made to the machine. Continue to pull into the boom until the hook openings are above the lock pins.	62; FIGURE 4.62-1
4. Turn the engine OFF before connecting any hoses or electrical lines.	
5. Re-attach all solution lines, electrical lines, and hydraulic lines. If you are attaching to something other than the boom, be sure you read the operators' manual for the attachment to know what lines will need to be hooked up and where the connection is.	62; FIGURES 4.62-2
6. Lift the boom until the hooks have engaged fully.	63; FIGURE 4.63-1
7. Lock the quick attach lock assemblies. Be sure that the assembly is fully engaged!	63; FIGURE 4.63-1
8. Put the boom stands in the "travel position".	63; FIGURE 4.63-2
9. Continue with your spray job.	63; FIGURE 4.63-3

IV. OPERATING SYSTEMS

E. OPERATING THE QUICK-ATTACH SYSTEM

PULL INTO THE ATTACHMENT– Slowly pull into the boom.

ARE THE HOOKS HIGH ENOUGH?- Check to see that the quick attach hooks are high enough to clear the lock pins (fig. 4.62-1). Due to soil settling or the difference in the airbag pressure without the boom on, you may need to let some air out of the airbags using the relief valves. If your machine is not equipped with the valves, you will need to call Hagie Customer Service and purchase airbag relief valve kits and install them on the front leg assemblies.

Once you have made any necessary adjustments you can continue to drive into the boom until the hooks are above the lock pins.



FIG. 4.62-1



WARNING

Turn the engine OFF before disconnecting any hoses or electrical lines! Failure to do so may result in serious injury or death.

RECONNECT ALL HYDRAULIC, ELECTRICAL, AND SOLUTION LINES– Reconnect all the necessary lines between the machine and the boom. If connecting to another attachment other than the boom, make sure that you read the operator and parts manual for the attachment and understand how to connect it.



FIG. 4.62-2

IV. OPERATING SYSTEMS

E. OPERATING THE QUICK-ATTACH SYSTEM

LIFT THE BOOM– Lifting the boom will allow the weight of the boom to pull the hooks over the lock pins. Once the hooks are fully over the lock pins, be sure to engage the lock assemblies. **Do not operate the boom without the full engagement of the lock assemblies!**

You will notice the change of weight again as the machine begins to support the boom.



FIG. 4.63-1

CAUTION

DO NOT OPERATE ATTACHMENTS WITHOUT FULL ENGAGEMENT OF QUICK ATTACH LOCK ASSEMBLY

Disengaged



FIG. 4.63-2

BOOM STANDS–While you are engaging the lock assemblies, put the boom stands in “travel” position by removing the pin and sliding the leg all the way up. Re-insert the pin above the bracket to keep the leg in place.

Do not try to move the machine a great distance without doing this step! You risk catching the stands on the ground causing unnecessary damage to the stands and to the boom. You may also damage the machine.

Fully Engaged

A diagram showing the boom stand in travel position. The stand is silver and the boom is yellow. The stand is being moved up and down. A red circle with a diagonal line through it is overlaid on the diagram, indicating that this position is not to be used. The number 650178 is visible in the bottom right corner.

CONTINUE WITH YOUR SPRAY JOB– DO NOT FORGET to adjust you booms BEFORE moving the machine. Continue with your spray job.



FIG. 4.63-3

V. CALIBRATION

A. INTRODUCTION

INTRODUCTION

It is important to apply chemicals as recommended by the manufacturer's of the product. In order to do so, the spraying system must be properly calibrated.

Determine the speed at which the sprayer will be driven while applying the chemicals. To select the best speed, consider the lay of the land, the weather conditions, and the type of chemicals being applied.

Select the nozzles spacing (distance between each nozzle on the spray boom) best suited for the intended spraying job. For help in determining the nozzle spacing and height of the boom, refer to the Spray Product Catalog that accompanies this manual.

There are several types and sizes of nozzles. Select (as recommended by the catalog) and install the type and size of nozzles best suited for the intended spraying job. The type of nozzle will be based on the product being sprayed and the type of crop it is being use on. The size of nozzles selected will be based upon the speed the sprayer will travel, the nozzle spacing, and the number of gallons one intends to apply per 1000 sq.ft.

IMPORTANT:

**The key to an effective spray job starts with
the selection of the spray tip!**

Refer to the Spray Product Catalog that accompanies this manual for more information.

TIP SELECTION:

There are several things to consider when selecting the type of nozzle you need for the intended spray job. Whatever your personal preference is, be sure that the nozzle complies with the chemical manufacturer's standards for spray control and also any environmental standards that might be in place for your region. (Some regions may have restrictions on "drift" control)

Once you have chosen a type of nozzle, you must choose the size of the nozzle. There are **3** main things to consider when choosing the size: **1)** recommendation of gallons per 1000 sq.ft. by the chemical manufacturer, **2)** the speed in which you intend to travel while spraying, **3)** and the nozzle spacing (distance between tips). (See the next page for information on how to use this information to select a tip size)

V. CALIBRATION

A. INTRODUCTION

Example of de-icing solution Rate Cal

For the purpose of de-icing solutions, we have chosen to look at the fertilizer nozzles. *This is an example that is based on feedback from our customers, it should not be construed as a recommendation of what type of nozzle you should be using for your spray job.*

1. First you must know the weight of the solution you intend to spray. The tabulations on the spray tip guide are based on the weight of water. Therefore you must convert the weight of the solution to that of water to appropriately find the best nozzle.

Ex: You intend to apply 1 gallon per 1000sq.ft., your solution weight is 9 pounds per gallon. The conversion factor is 1.04: **1g/1000 sq.ft. x 1.04=1.04g/1000 sq.ft.**

2. Now figure your gallons per minute using the following formula: **GPM= $\frac{G}{1000\text{sq.ft.} \times \text{speed} \times \text{spacing}}{136}$ (constant)**

Ex: You have a 15" nozzle spacing on your booms. You wish to travel at 20 MPH.

$$\text{GPM} = \frac{1.04 \times 20 \times 15}{136} \rightarrow \frac{312}{136} = 2.29\text{GPM}$$

3. The nozzles are not configured in the 1000 sq.ft of the turf application and must be converted from GPA. So knowing that the adjusted application rate is 1.04g/1000 sq.ft. and that 1g/1000 sq.ft. is 43.56GPA you multiply: **1.04g/1000 sq.ft. x 43.56GPA= 45.3024GPA**

4. The tabulations in the spray nozzle guide are figured considering a 20" nozzle spacing, yours is 15". You must multiply the GPA of both the tabulation in the guide book and the above calculation by 1.32:

45.3024GPA x 1.32= 59.80 GPA

Continued on the next page

V. CALIBRATION

A. INTRODUCTION

Example of de-icing solution Rate Cal

NOZZLE SIZE	PSI	CAP. 1 NOZZLE IN GPM	3	5	6	8	10	12	16	20
SJ3-08-VP	20	0.56	72.60	43.56	36.96	27.72	21.91	15.71	13.73	10.96
	30	0.72	93.72	56.76	47.52	35.64	27.72	20.20	17.69	14.12
	40	0.80	104.28	63.36	52.80	39.60	31.68	22.44	19.67	15.71
	50	0.88	114.84	68.64	58.08	43.56	34.32	24.68	21.52	17.29
	60	0.94	122.76	73.92	62.04	46.20	36.96	26.27	22.97	18.48
SJ3-10-VP	20	0.65	84.48	51.48	42.24	31.68	25.48	18.22	15.97	12.80
	30	0.90	117.48	69.96	59.40	43.56	35.64	25.21	22.04	17.69
	40	1.00	130.68	77.88	66.00	48.84	39.60	27.72	24.55	19.67
	50	1.11	145.20	87.12	72.60	54.12	43.56	31.68	27.72	21.78
	60	1.19	155.76	93.72	77.88	58.08	46.20	33.00	29.04	23.36
SJ3-15-VP	20	0.99	129.36	77.88	64.68	48.84	38.28	27.72	24.29	19.40
	30	1.24	162.36	97.68	80.52	60.72	48.84	34.32	30.36	24.29
	40	1.50	196.68	117.48	97.68	73.92	59.40	42.24	36.96	29.04
	50	1.68	219.12	132.00	109.56	81.84	66.00	47.52	40.92	33.00
	60	1.83	238.92	143.88	120.12	89.76	71.28	51.48	44.88	35.64
SJ3-20-VP	20	1.41	184.80	110.88	92.40	68.64	55.44	39.60	34.32	27.72
	30	1.75	228.36	137.28	114.84	85.80	68.64	48.84	42.24	34.32
	40	2.00	261.36	157.08	130.68	97.68	77.88	55.44	48.84	39.60
	50	2.28	298.32	178.20	149.16	112.20	89.76	63.36	55.44	44.88
	60	2.49	326.04	195.36	162.36	121.44	97.68	69.96	60.72	48.84

This chart represents the gallons per acre after being converted to a 15" spacing.

5. Now that you know your GPM (2.29) and the GPA (59.80) you can find a nozzle that best matches your needs. The SJ3-20-VP best matches what you are looking for.

Remember that you may not find the exact match, this is just a guideline to help determine what nozzle will be the *closest* match and able to perform according to your needs. There are other factors that will get the application rate where you want it to be.

Always consider the purpose of the spray job when selecting a nozzle type. This nozzle type was determined by the job it was intended to do (de-icing). A different nozzle may be needed to apply insecticides and herbicides in the spring and summer months.

* This is just an example based on feedback from our customers. Hagie Manufacturing can not account for the infinitely variable situations that may be unique to each machine, operator, climate, and other conditions.

V. CALIBRATION

B. PROGRAMMING THE RAVEN CONSOLE

THIS IS JUST A GUIDE TO GET STARTED! REFER TO THE RAVEN INSTALLATION AND OPERATION MANUAL FOR MORE INFORMATION AND TROUBLE SHOOTING.

IMPORTANT:

Remember that the performance of the nozzle and the spray system is dependant on the performance of the operator. If the system is operated within the parameters of the nozzle type and the machine/console set up, you will see greater success with your application. Operating the machine even one or two miles per hour faster or slower than intended will greatly change the outcome of the programmed spray job.

NOTE: DATA MUST BE ENTERED INTO KEYS 3 THRU 7.

GETTING STARTED:

1. The entry sequence is always the same; 1) depress the key in which you wish to enter data, 2) depress the ENTER key (an E will illuminate in the screen), 3) depress the keys corresponding to the number you wish to enter (the numbers will be displayed as they are entered), 4) complete the entry by again pressing the ENTER key.
2. When the console is initially turned on, it will flash CAL and display ACRE US. This means that the console must be calibrated or programmed before it can be operated. Once the console is calibrated or programmed, you will not have to do it again unless you wish to make changes. All data is retained if the console is turned off.
3. If any error is made during the programming of the area measurement standard or the valve type, turn the console OFF. Depress CE and hold while turning the console power ON.

IMPORTANT! The information contained in this section is not meant to replace the information contained in the Raven's operational manual or the instructions of the chemical manufacturer. The information may need to be adjusted to suit the varying conditions under which the machine is being used. We can not account for the infinitely variable situations that may be unique to each machine, operator, and intended spray job.

V. CALIBRATION

B. PROGRAMMING THE RAVEN CONSOLE

THIS IS JUST A GUIDE TO GET STARTED! REFER TO THE RAVEN INSTALLATION AND OPERATION MANUAL FOR MORE INFORMATION AND TROUBLE SHOOTING.

Momentarily depressing the **CE** key is similar to using an arrow key to scroll through menu selections.

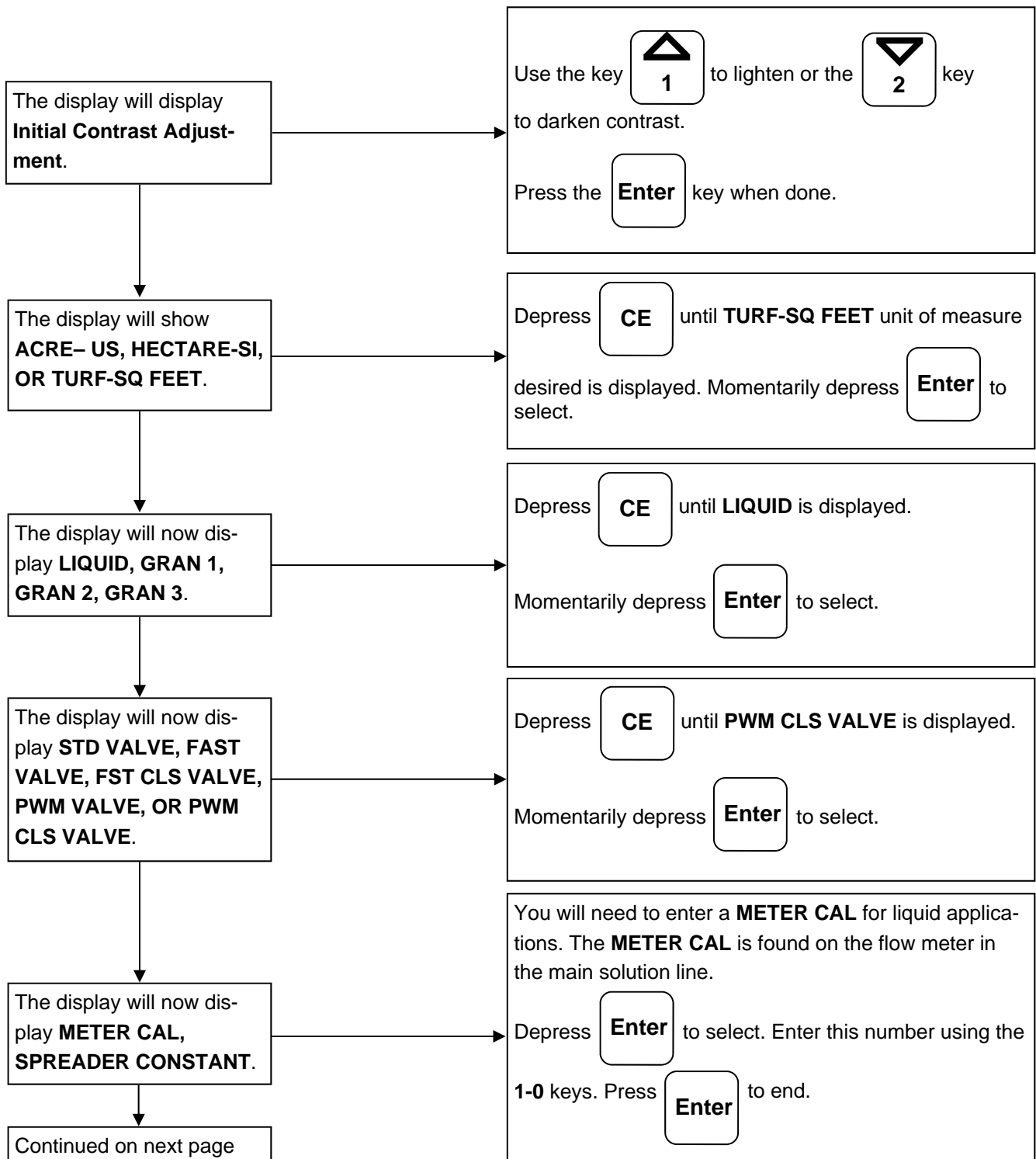

V. CALIBRATION

B. PROGRAMMING THE RAVEN CONSOLE

THIS IS JUST A GUIDE TO GET STARTED! REFER TO THE RAVEN INSTALLATION AND OPERATION MANUAL FOR MORE INFORMATION AND TROUBLE SHOOTING.

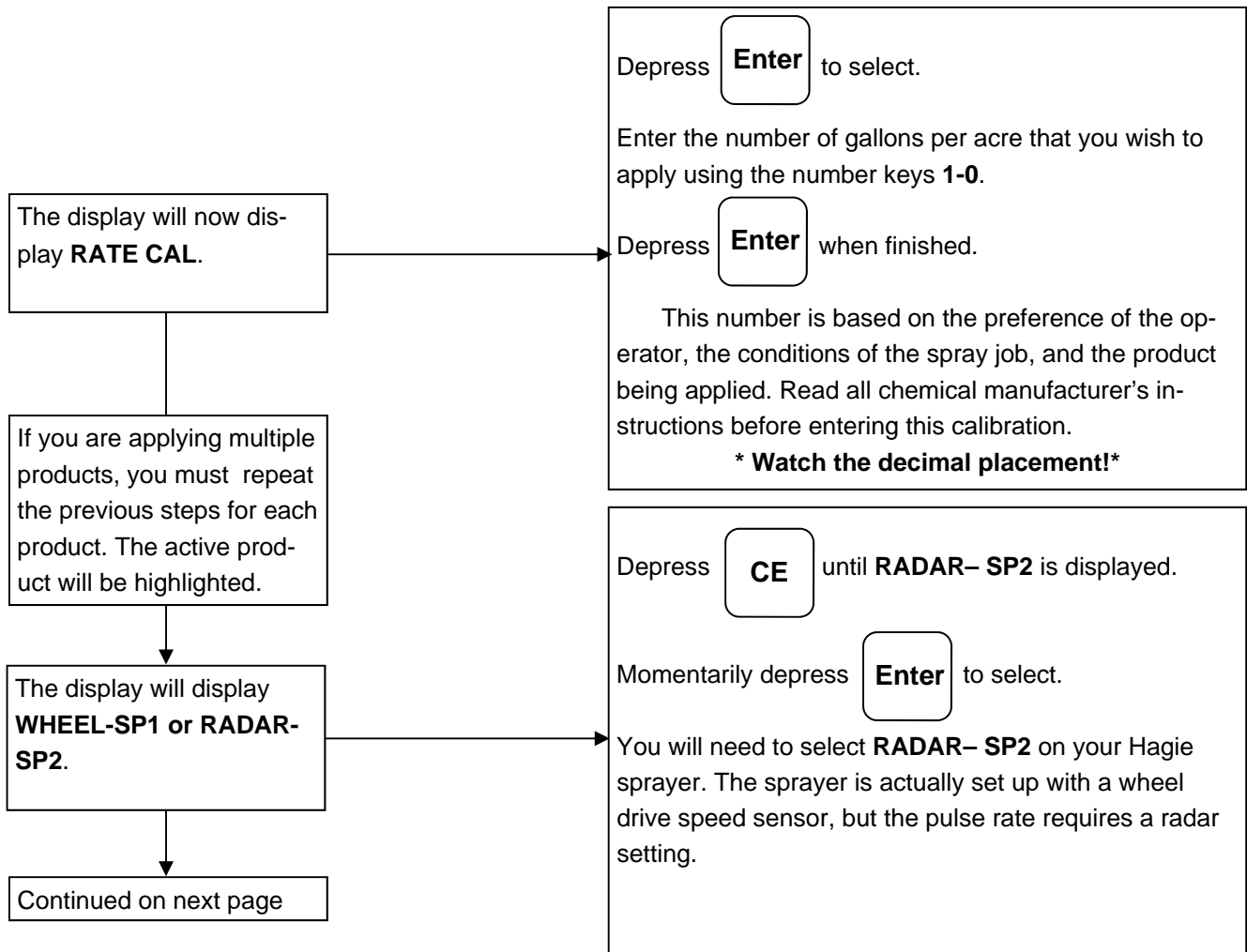

V. CALIBRATION

B. PROGRAMMING THE RAVEN CONSOLE

THIS IS JUST A GUIDE TO GET STARTED! REFER TO THE RAVEN INSTALLATION AND OPERATION MANUAL FOR MORE INFORMATION AND TROUBLE SHOOTING.

The display will now display **SPEED CAL.**

The initial **SPEED CAL** is dependent on the size of tire installed on your machine. Below is a chart to get you started.

Depress **Enter** to select. Enter the number using the **1-0** keys.

The **SPEED CAL** may need to be refined after the initial programming of the console. Refer to the Raven manual for more information.

The speed that is displayed on the Raven console, if the console is programmed correctly and the **SPEED CAL** is refined as necessary, should closely match the speed displayed on the MDM.

Depress **Enter** when finished.

GST 20 RAVEN CALS

	14R25 3*
Bonfiglioli Hubs	348

Continued on next page

V. CALIBRATION

B. PROGRAMMING THE RAVEN CONSOLE

THIS IS JUST A GUIDE TO GET STARTED! REFER TO THE RAVEN INSTALLATION AND OPERATION MANUAL FOR MORE INFORMATION AND TROUBLE SHOOTING.

Depress the **BOOM CAL 3** key to enter the **BOOM CAL** number.

After depressing the **BOOM CAL 3** key, the **1** key and the **2** key will allow you to scroll through the different boom numbers.

To determine the **BOOM CAL** number, you will need to know how the boom is divided (the number of valves and what they control), the spacing option installed, and the number of nozzles per section.

The boom is numbered from left to right which is your "BOOM #" and corresponds with the **BOOM SPRAY SECTION** switches on the console.

To get the **BOOM CAL** number, multiply the number of nozzle tips by the spacing in inches.

You must enter "0" in Boom Cal 1 and 7.

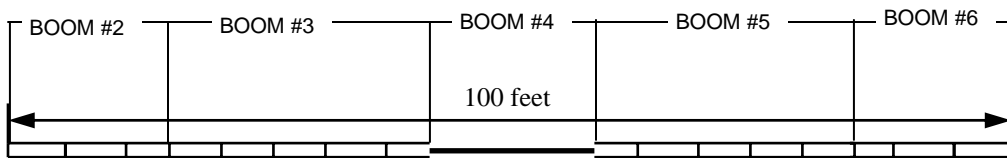

60/100 foot boom system with extensions folded out.

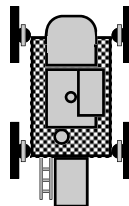

* remember that there is a blank in the first position, therefore your calibration will begin with BOOM #2.

V. CALIBRATION

B. PROGRAMMING THE RAVEN CONSOLE

THIS IS JUST A GETTING STARTED GUIDE! REFER TO THE RAVEN INSTALLATION AND OPERATION MANUAL FOR MORE INFORMATION AND TROUBLE SHOOTING.

To complete calibration you will need to enter some additional information.

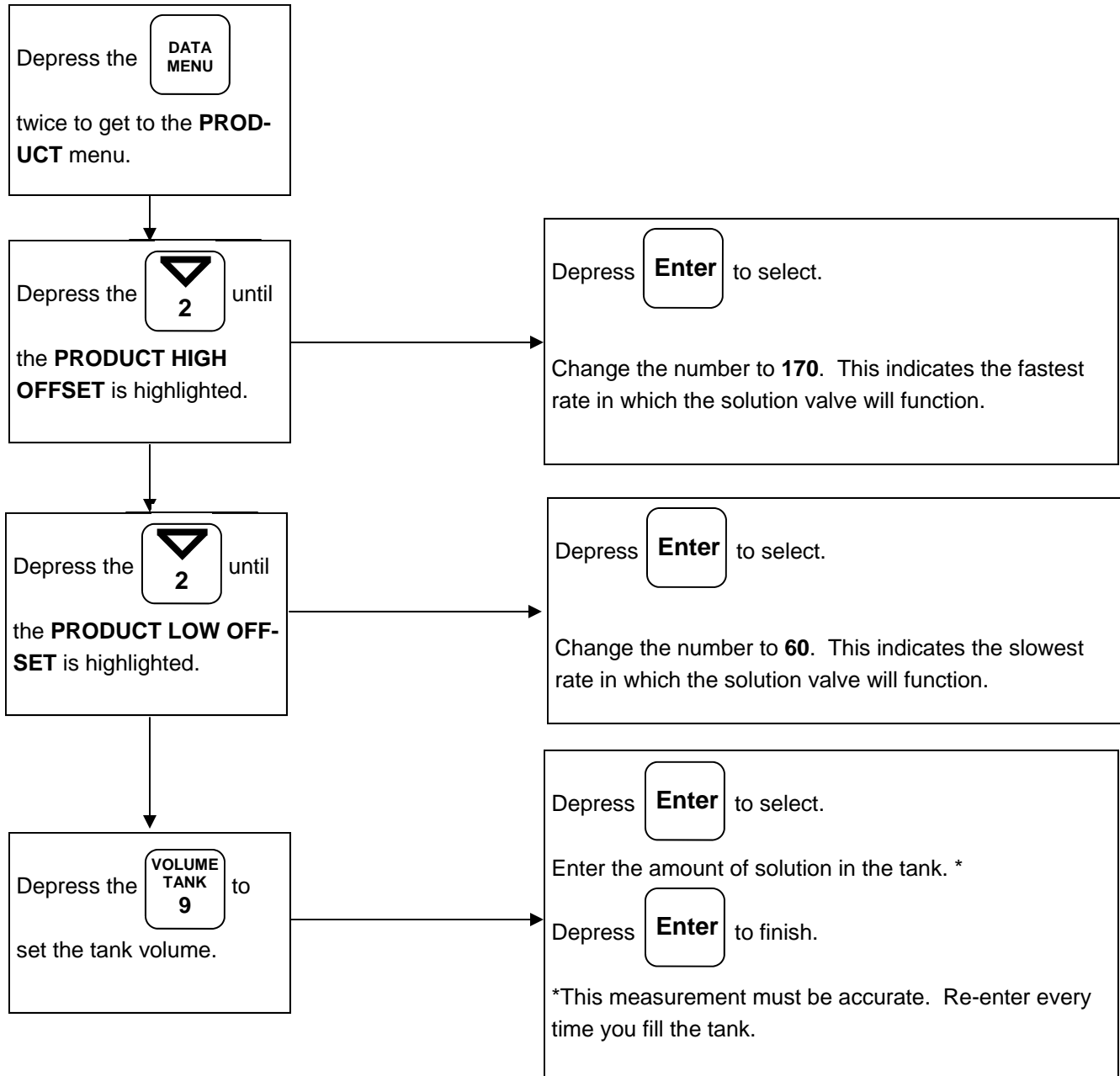

The initial programming is now complete. You may have to refine some of the numbers to better suit your unique situation. This is just a guide to get you started, these numbers may not be specific to your machine. We can not account for every individual situation.

V. CALIBRATION

B. PROGRAMMING THE RAVEN CONSOLE

THIS IS JUST A GETTING STARTED GUIDE! REFER TO THE RAVEN INSTALLATION AND OPERATION MANUAL FOR MORE INFORMATION AND TROUBLE SHOOTING.



IMPORTANT:

DO NOT ADD CHEMICALS UNTIL CALIBRATION IS COMPLETED!

VERIFYING CALIBRATION

To test your system, fill the solution tanks with clean water. Do not add chemicals until calibration is completed!

With brakes applied, start the engine of the sprayer, throttle the engine to operating speed and remain parked. Turn on the Raven console. Turn on the work mode switch. Turn on the solution tank valve located on the right hand console. Turn on the main solution switch located on the hydrostatic lever. Turn on all boom section solution switches. Make sure there are no leaks and that all nozzles are spraying a desirable pattern. Continue spraying in the stationary position for at least 10 minutes for proper warm up of the sprayer and its system.

Once the system has had an adequate warm up period, you will need to perform a “self test” to simulate speed although the machine will remain stationary. (See the next page on quick instruction for performing a “self test”) Collect one nozzle’s spray for one minute in an adequately sized and marked container.

Verify that the collection equals or is close to the gallons per minute for the nozzle, pressure, speed, gallons per acre, and spacing that you are using.

V. CALIBRATION

B. PROGRAMMING THE RAVEN CONSOLE

THIS IS JUST A GETTING STARTED GUIDE! REFER TO THE RAVEN INSTALLATION AND OPERATION MANUAL FOR MORE INFORMATION AND TROUBLE SHOOTING.

Performing a SELF TEST

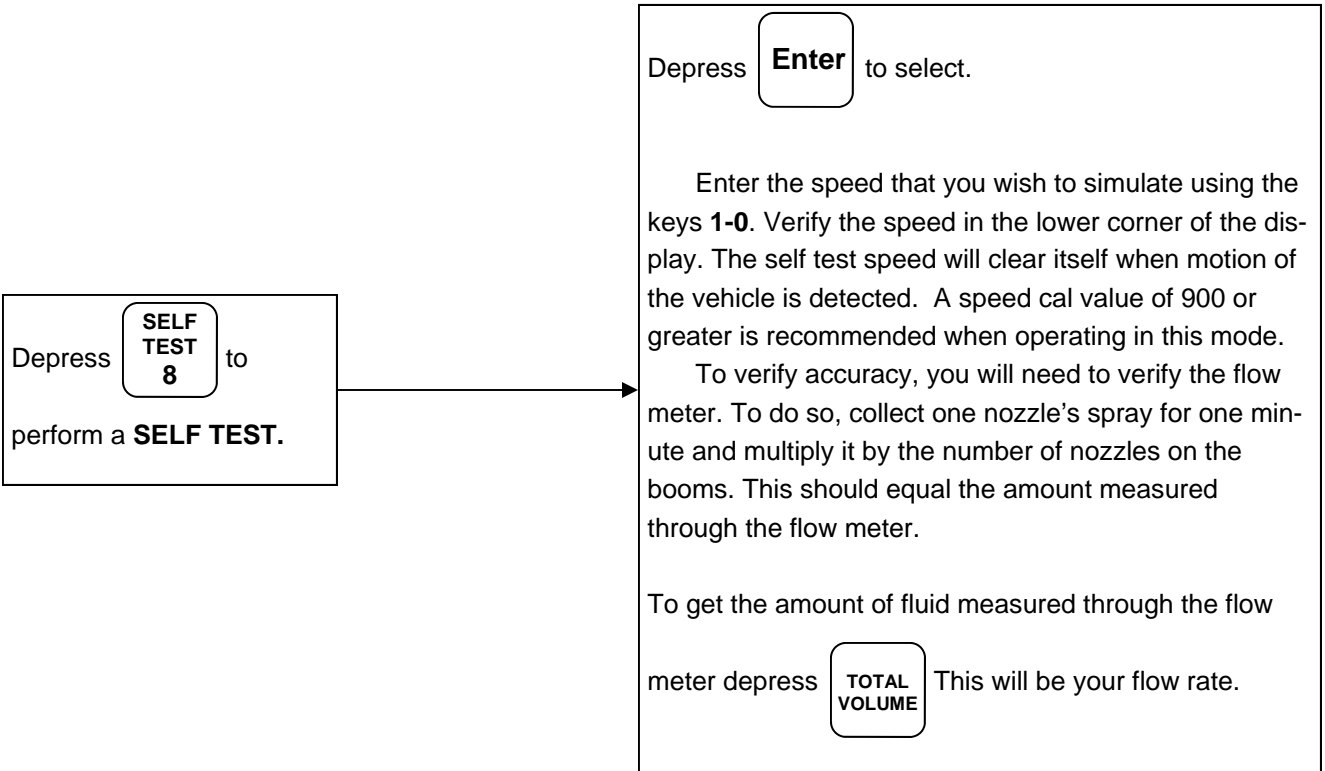

Changing VALVE CAL

*The **VALVE CAL** number is preprogrammed as 0043, but can be adjusted to suit your needs. Refer to the Raven manual for instructions.

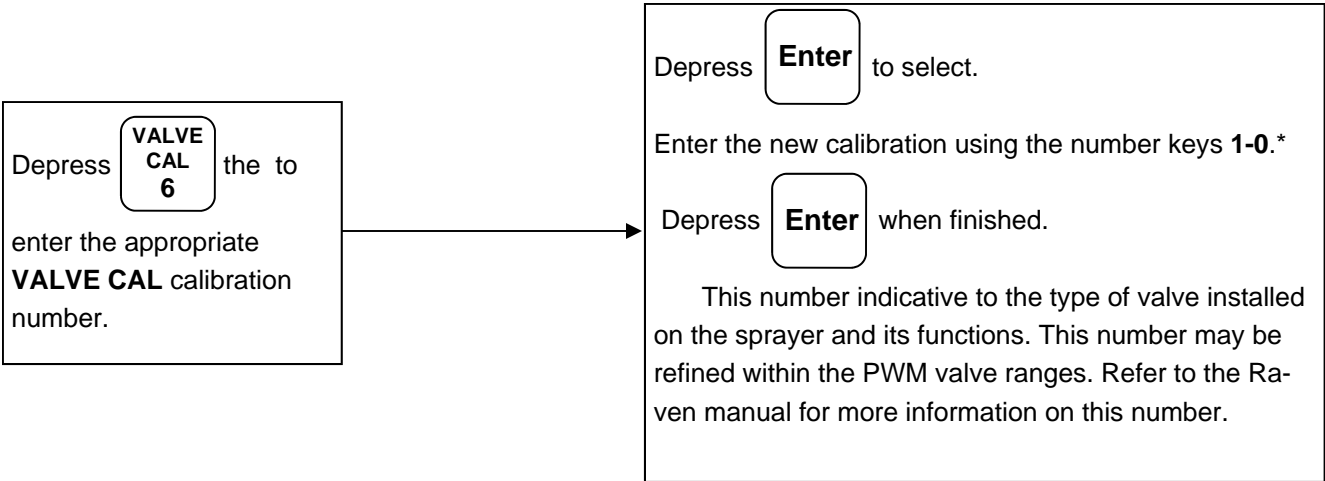

VI. TRANSPORTING

A. CRADLING THE BOOMS

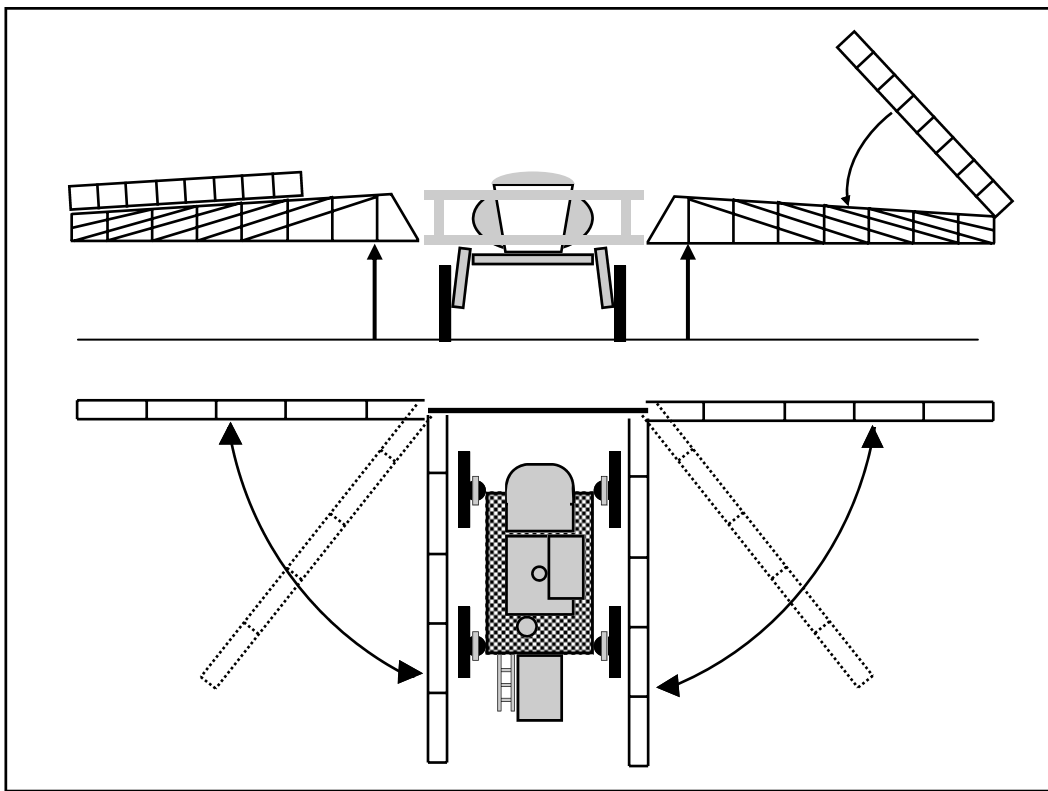

The booms should always be cradled before traveling, transporting, or parking for an extended period of time. **The booms must be folded when cradled.**

To cradle the booms, fold the boom extensions in, raise the transom, and fold the booms in toward the machine. When the boom reaches the last 8-10 degrees of travel, it will automatically slow down to avoid impact with the cradle. Raise each individual boom level until it clears the outer cradle stop (fig. 6.75-1). Fold the boom in toward the cradle back-stop. When it touches the back-stop, lower the boom level until the full weight of the boom rests in the cradle (fig. 6.75-2).

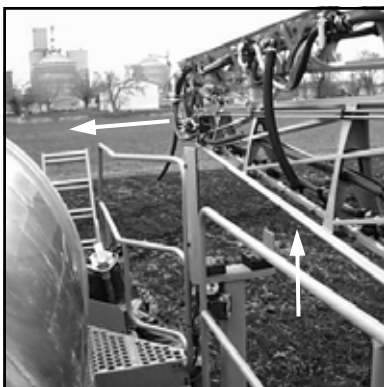

FIG 6.75-1



FIG 6.75-2

VI. TRANSPORTING

B. DRIVING

WHEN DRIVING THE GST ON A PUBLIC ROAD OR HIGHWAY, DRIVE CAREFULLY AND FOLLOW THESE STEPS:

1. Always have the booms in the folded position and cradled when driving or transporting.
2. Flashing hazard/warning lights have been placed on the GST to warn other drivers.
3. Know and obey all state laws for driving farm equipment on a public road or highway.
4. Adjust the sprayer's speed to suit the conditions.
5. Slow down and use turn signals before turning.
6. Pull over to the side of the road before stopping.
7. Keep a proper lookout, and maintain control of the sprayer.
8. Do not drive under trees, bridges, wires, or other obstructions unless there is clearance.
9. Use extra care before entering or leaving a public road or highway.
10. A SMV (Slow Moving Vehicle) emblem has been mounted on the GST to warn other drivers that one is moving slowly. Keep it properly displayed, unless prohibited by law.



 Hagie Manufacturing Company does not recommend any form of transportation other than driving the GST.

VI. TRANSPORTING

C. EMERGENCY TOWING PROCEDURES

If it is necessary to tow the machine, follow these steps completely:

1. Remove the uppermost plug on each drive hub.
2. Remove the wheel motor shield from all four wheels by removing the clip pins and pulling the shield off the pins. Then you may lift the shield up and off the front cap screws using the key hole slots in the shield.
3. Loosen and remove the bolts holding the motors in the drive hub.
4. Pull the motor out of the drive hub. You may need to use a standard screwdriver to pry the motor free. There will be some oil that drains from the hub when the motor is removed– use a collection pan to collect as much of the oil as possible.
5. Using a wire or chain, support the wheel motor from the frame. Do not allow it to hang from the hydraulic hoses.
6. Reinstall the plugs in the drive hubs.
7. Lower the rear belly shield by removing the clip pins along the front edge.
8. Turn the brake release valve located on the top of the rear axel behind the deluge tank.
9. Climb onto the machine, turn the valve on the back of the brake release pump, and pump until the pressure relief squeals a few times (10 to 12 pumps)
10. Attach chains to the rear towing loops on the bottom of the machine and **slowly** tow the machine backwards.

NOTE:

The Model GST should only be towed backwards. Follow the towing instructions completely or machine damage will occur and void the power train warranty.



Hagie Manufacturing Company does not recommend any form of transportation other than driving the GST.

VII. SERVICE AND MAINTENANCE

A. SERVICE POINT QUICK REFERENCE CHART

PAGE #	SERVICE POINT	CLEAN	CHANGE	CHECK	GREASE	DRAIN
83	ENGINE OIL		500HRS	DAILY		
89	ENGINE LUBE FILTER		500HRS			
85	RADIATOR COOLANT		1000HRS	DAILY		
85	COOLANT CONCENTRATION		AS REQ	500HRS		
88	RADIATOR GRILLE SCREEN	AS REQ		DAILY		
94	ENGINE DRIVE BELT		AS REQ	DAILY		
94	A/C COMPRESSOR BELT		AS REQ	250HRS		
84	A/C COMPRESSOR		B			
89	FUEL FILTER (WATER SEPARATOR)		500HRS*			DAILY
89	REMOTE FUEL FILTER		500HRS*			
89	IN-LINE FUEL STRAINER		500HRS*			
87	AIR INTAKE FILTER	I	C			
87	FILTER MINDER®		D	DAILY		
83	HYDRAULIC RESERVOIR OIL LEVEL		500HRS	DAILY		
88	HYDRAULIC RETURN/SUCTION FILTER		E*			
88	HYDRAULIC SUCTION STRAINER	500HRS				
90	SOLUTION LINE STRAINER	AS REQ		DAILY		
84	WHEEL HUB OIL LEVEL		F*	100HRS		
99	WET TANK/AIR TANK					A
99	AIR DRYER CARTRIDGE		1000HRS	50HRS		
91	FRONT LEG STRG ZERKS (2- 1EA LEG)				50HRS	
91	ALL OTHER GREASE ZERKS (19 PLACES)				50HRS	
96	TREAD ADJUSTMENT BEARING TORQUE		AS REQ	J		
92	BATTERIES	100HRS	AS REQ	DAILY		
95	LUG NUT TORQUE			G		
99	TIRE PRESSURE			50HRS		
90	FRESH AIR (PAPER) CAB FILTER	50HRS	AS REQ			
90	CHARCOAL CAB FILTER		AS REQ			
100	SPRAY NOZZLE DIAPHRAGMS & TIPS		1000HRS	500HRS*		
99	AIRBAGS (VISUALLY)			50HRS		
86	DELUGE TANK			DAILY		
	ENGINE EXHAUST BRAKE			K		

- *AT THE BEGINNING OF THE SEASON (YEARLY) OR AS REQUIRED, WHICHEVER COMES FIRST
- NOTE A: CHECK FOR EXCESSIVE MOISTURE
- NOTE B: CHARGE AS REQ; USE PROPER EQUIPMENT
- NOTE C: FOLLOW FILTER MINDER READINGS
- NOTE D: RESET EACH TIME YOU SERVICE AIR FILTER
- NOTE E: 1ST 50HRS, THEN 250HRS THEREAFTER

- NOTE F: 1ST 50HRS, THEN YEARLY
- NOTE G: IMMEDIATELY, THEN 50HRS THEREAFTER
- NOTE I: NOT RECOMMENDED
- NOTE J: VISUALLY CHECK THE BOLTS EVERY 50 HOURS, TORQUE CHECK THEM EVERY 100 HOURS
- NOTE K: CHECK EVERY 1000HRS, CALL CUMMINS CUSTOMER SERVICE FOR REPAIR AND REPLACEMENT

VII. SERVICE AND MAINTENANCE

A. SERVICE POINT QUICK REFERENCE CHART

SERVICE INTERVALS

Initial checks after receiving machine

IMMEDIATELY  then 

- 1) Check lug nut torque, then every 50 hours (page 95)

FIRST 50 HOURS  then 

- 1) Change wheel hub oil, again at 100 hours, and then every 500 hours thereafter (page 84)
- 2) Change hydraulic return/suction filter, then every 250 hours thereafter (page 88)

Daily 

- 1) Check engine oil (page 83)
- 2) Check and drain fuel filter (water separator) (page 89)
- 3) Check radiator coolant level (page 85)
- 4) Check engine drive belt (page 94)
- 5) Check Filter Minder[®] (page 87)
- 6) Check hydraulic oil reservoir level (page 83)
- 7) Check solution line strainer (page 89)
- 8) Drain wet tank and air tank (page 99)
- 9) Check batteries (page 92)
- 10) Check radiator grille screen (88)

VII. SERVICE AND MAINTENANCE

A. SERVICE POINT QUICK REFERENCE CHART

As Required



- 1) Change coolant concentration (page 85)
- 2) Clean radiator grille screen (page 88)
- 3) Change engine drive belt (page 94)
- 4) Change A/C compressor belt (page 94)
- 5) Charge A/C compressor (page 84)
- 6) Change fuel filter (water separator) (page 89)
- 7) Change in-line fuel strainer and remote fuel filter (page 89)
- 8) Clean solution line strainer (page 90)
- 9) Change batteries (page 92)
- 10) Change paper cab filter (page 90)
- 11) Change charcoal cab filter (page 90)
- 12) Check and replace spray nozzle diaphragms and spray tip (page 100)

Every 50 HOURS



- 1) Check tire pressure (page 99)
- 2) Check lug nut torque (page 95)
- 3) Visually inspect tread adjust bearing bolts (page 96)
- 4) Grease all lubrication zerks (page 91)
- 5) Knock particles from fresh air intake cab filter (page 90)
- 6) Check air dryer cartridge (page 99)

Every 100 HOURS



- 1) Check wheel hub oil level (page 84)
- 2) Clean batteries (page 92)
- 3) Check tread adjust bearing bolt torque (page 96)

VII. SERVICE AND MAINTENANCE

A. SERVICE POINT QUICK REFERENCE CHART

Every 250 HOURS



- 1) Check A/C compressor belt (page 94)
- 2) Change hydrostatic charge pressure and suction filter (page 88)

Every 500 HOURS



or



- 1) Check coolant concentration (page 85)
- 2) Change fuel filter (water separator) (page 89)
- 3) Change hydraulic reservoir oil (page 83)
- 4) Change wheel hub oil (page 84)
- 5) Check spray nozzle diaphragms and spray tips (page 100)
- 6) Change engine oil (page 83) and lube filter (89)
- 7) Change the in-line fuel strainer (page 89)
- 8) Change the remote fuel filter (page 89)

Every 1000 HOURS



or



- 1) Change radiator coolant (page 85)
- 2) Change air dryer cartridge (page 99)
- 3) Change spray nozzles and tips (page 100)
- 4) Check engine exhaust brake/ call Cummins customer service for repair or replacement

VII. SERVICE AND MAINTENANCE

A. SERVICE POINT QUICK REFERENCE CHART

DAILY INSPECTION

Inspection Point	Action (if necessary)
Check	
Engine oil level	Add oil
Radiator coolant level	Add antifreeze solution
Engine drive belt.....	Replace belt
Filter Minder®	Replace air filter element/ reset gauge
Hydraulic reservoir oil level.....	Add hydraulic oil
Solution line strainer	Remove and clean
Batteries	Clean and/or tighten
Radiator grille screen	Clean
Look for loose or missing items such as shields.....	Tighten or replace
Look for any fluid leaks pooled on machine or ground	Determine cause and correct

Drain

Fuel/water separator	See page 89
Wet tank/air tank	See page 99

VII. SERVICE AND MAINTENANCE

B. FLUIDS

ENGINE OIL

OIL LEVEL-The engine oil level dipstick is located on the left-hand side of the engine (fig. 7.83-1). Never operate the engine with the oil level below the “L” (low) mark or above the “H” (high) mark. Wait at least five minutes after shutting off the engine to check the oil level, this allows the oil to drain to the oil pan. Check the engine oil level daily.

CAPACITY- Low to high mark capacity is 2.0 quarts. Engine oil pan capacity is 17 quarts. Change every 500 hours. Refill with 15W40 diesel engine oil.



FIG 7.83-1

NOTE:

The engine must be level when checking the oil level to make sure the measurement is correct.

HYDRAULIC OIL RESERVOIR

OIL LEVEL- Check the sight gauge level on the hydraulic oil reservoir (fig. 7.83-2) daily. Add just enough fluid so the level is in the center of the sight gauge. Always check the hydraulic oil level when it is cool. Hydraulic oil will expand when heated.

TYPE- Premium hydraulic fluids containing high quality rust/oxidation/ and foam inhibitors are required equivalent to Mobil Unavis HVI 26. Hydraulic oil must conform to one of the following types: anti- wear hydraulic oil, type F automatic transmission fluid, or agricultural hydraulic transmission fluid. Replace the oil in the hydraulic reservoir at 500 hours or at the beginning of each spraying season, whichever comes first.



FIG 7.83-2

NOTE:

CLEANLINESS STANDARD: Always make sure area is clean before changing filter or hydraulic oil.

VII. SERVICE AND MAINTENANCE

B. FLUIDS

WHEEL HUB OIL

BONFIGLIOLI

OIL LEVEL— Each wheel hub should maintain a proper oil level at all times. Less than that would limit lubrication and over full would cause overheating and damage. To check the oil level, position the hub so one of the face plugs is positioned at 12 O'clock (fig. 7.84-1, item A). The other plug will be at 8 O'clock (fig. 84-1, item B). (When positioned correctly the arrows in the center of the hub should make an "L".) Remove the lower plug; if no oil comes out, the oil level is too low.

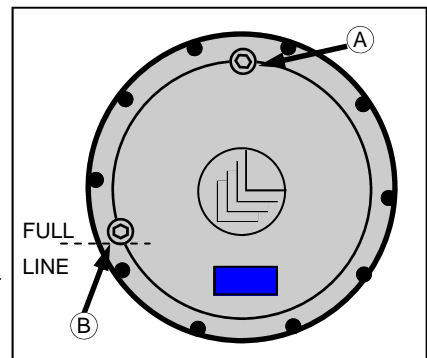

FIG 7.84-1

Check wheel hub oil level every 100 hours.

If SAE 80W/90 or SAE 85W/140 with EP features oil is needed, remove the top plug also and fill just until it starts to come out the lower hole (approximately 40 ounces). With the oil at a satisfactory level, re-install plugs.

CHANGE— The wheel hub oil should be changed after the first 50 hours of field operation. Subsequently, it should be changed every 500 hours or yearly (whichever comes first).

To change the wheel hub oil, position the plugs so that one is at the 6 O'clock position, and the other is between the 2 and 3 O'clock positions. Remove the bottom plug to drain the oil. Once all of the oil is drained, rotate the hub so that the plugs are in the filling position (fig. 7.84-1). Refill wheel hub with gear oil as described above.

GENERAL MAINTENANCE — If your GST is going to sit for an extended period of time, occasionally rotate the hubs by driving the sprayer forward and backward at least 1/2 of a tire rotation to adequately coat all internal hub parts. This will prevent rusting if moisture inadvertently entered the hub during an oil change. Failure to rotate the hub and disperse oil may cause rusting and internal damage to the hub.

AIR CONDITIONING

TYPE— The cab on your GST is equipped with a R-134a air conditioning system (fig. 7.84-2).

RECHARGING— Recharge it only with R-134a refrigerant. If your air conditioning system is mistakenly charged with R-12 refrigerant, serious problems, such as compressor seizure, may result. Therefore, confirm refrigerant before recharging system.

If you do not have the proper recharging equipment, it is recommended that you allow an independent service agent service your air conditioning system.

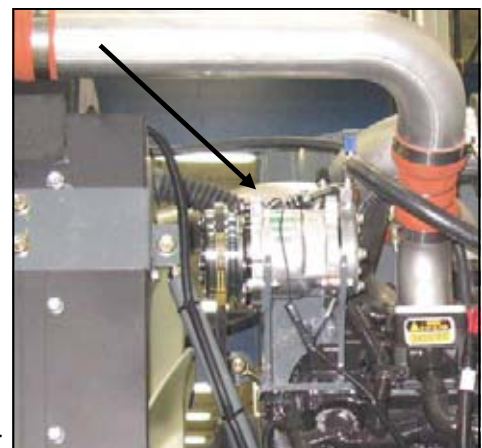

FIG 7.84-2

VII. SERVICE AND MAINTENANCE

B. FLUIDS

COOLING SYSTEM

COOLANT TYPE– Your cooling system should always be sufficiently charged with an adequate mixture of antifreeze and water, regardless of the climate, in order to maintain a broad operating temperature range. Your cooling system has been factory charged with an ethylene-glycol based antifreeze.

CHECKING CONCENTRATION– The radiator cap is located toward the rear of the engine compartment (fig. 7.85-1). Never remove the cap from a hot engine. Always allow the engine to cool before servicing the cooling system.



FIG 7.85-1

A 50/50 antifreeze/water mixture is a conservative mixture which allows good protection against both overheating and freezing. If a stronger antifreeze mixture is required, be sure not to exceed the engine manufacturer's guidelines for antifreeze mixing. The table in figure 7.85-2

Ethylene Glycol		
40%	-23°C	-10°F
50%	-37°C	-34°F
60%	-54°C	-65°F

gives a few examples of ethylene-glycol antifreeze/water mixture protection values. Consult the engine manufacturer's handbook for further information.

Concentration should be checked every 500 hours or at the beginning of each winter, whichever comes first. A refractometer should be used to check concentration, "floating ball" type density testers are not accurate enough for use with heavy duty diesel cooling systems.

FIG 7.85-2

CHANGING COOLANT– Your coolant should periodically be changed to eliminate the buildup of harmful chemicals. Drain and replace the coolant every other spraying season or 1,000 hours of service, whichever comes first. Refill only with soft water because hard water contains minerals which break down the anti-corrosion properties of antifreeze.



VII. SERVICE AND MAINTENANCE

B. FLUIDS

FUEL

TYPE– No. 2 diesel fuel is recommended for the best economy and performance under most operating conditions. In operating conditions under 32°F, use a blend of No. 1 and No. 2 diesel fuel. The addition of No. 1 diesel fuel may cause loss of power and/or fuel economy.

STORING–See section 6 on storage.

REFUELING– Always turn off the engine and allow it to cool before refueling. Never smoke while fueling. Keep a fire extinguisher within reach while refueling.

The fuel cell on GST holds 150 gallons– do not fill it completely: fuel can expand and run over. Wipe up all spilled fuel and clean with detergent and water before starting the engine.



DELUGE SOLUTION

The deluge system should be checked daily using the tank level sight gauge (fig. 7.86.1, item 1). Fill it as required with deluge solution or approved windshield washing solution.

To fill the tank, open the 2" ball valve on the top and add desired amount of solution (fig. 7.86.1, item 2).

Check the nozzles for wear, damage, or blockage during routine maintenance or if they begin to spray erratically. The nozzles for the side windows are located on the light brackets (fig. 7.86.3) and the nozzles for the front windshield are mounted on the front panel (fig.7.86.4). There are six nozzles mounted around the cab.

The electric motor for the system is located on the back of the mounting bracket (fig. 7.86.2)

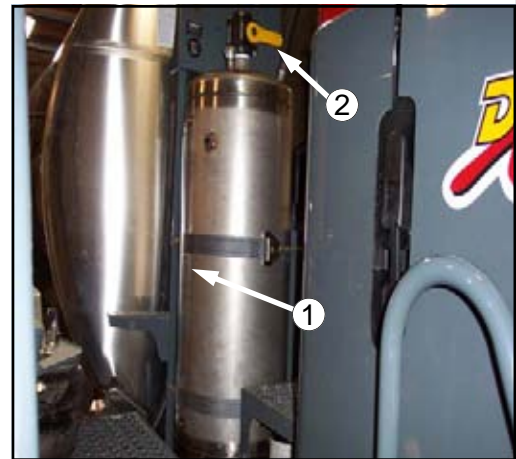

FIG 7.86.1



FIG 7.86.2

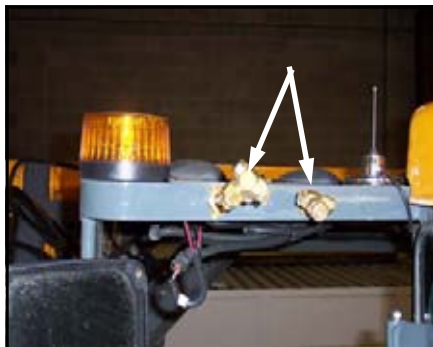

FIG 7.86.3



FIG 7.86.4

VII. SERVICE AND MAINTENANCE

C. FILTERS

ENGINE AIR INTAKE

LOCATION– The engine air intake filter is accessed by opening the door on the front of the engine compartment (fig. 7.87-1).

REMOVAL– The engine air intake filter element should only be removed if it is going to be replaced. After loosening the air cleaner clamp and removing the end cap, carefully remove the filter so as to not knock any dust off the filter and into the air intake passage (fig. 7.87-2). The secondary filter does not need to be replaced if the primary is intact.

REPLACEMENT– Your sprayer is equipped with a Filter Minder® to notify you of filter element efficiency. Follow its guidelines for servicing (see below). At appropriate service time, install the new element carefully to ensure proper sealing.

CLEANING– It is not recommended to clean the air intake filter element. However, a clean damp cloth should be used to wipe away dust and foreign material from the air cleaner housing.



FIG 7.87-1



FIG 7.87-2

NOTE:

Do not tap filter to remove dust. Engine damage may occur due to crushed filter caused by tapping. If Filter Minder® indicates restriction, remove old filter, discard and install new filter only.

FILTER MINDER®

LOCATION– The Filter Minder® is an air restriction monitoring system that progressively and constantly indicates how much air filter capacity remains. It is mounted on the foamer bracket (fig. 7.87-3). Check its reading daily.

SERVICE– Service the air cleaner when the Filter Minder® reads 20" (80% of dirt holding capacity).

NOTE:

Service the air cleaner before the yellow indicator reaches the red line of the Filter Minder®.



FIG 7.87-3

VII. SERVICE AND MAINTENANCE

C. FILTERS

RADIATOR SCREEN– In order to maintain air flow through the engine cooling system’s radiator, oil cooler, and air conditioning condenser, the cooling air intake grille (fig. 7.88-1) must be inspected often and periodically cleaned.

When the engine hood has been opened for servicing, use compressed air to dislodge most large trash and dirt. Blow out the screen AWAY from the machine. Water from a pressurized hose may also be used, or if necessary the screen may be soaked with soapy water and scrubbed gently with a brush.



FIG 7.88-1

NOTE:

When cleaning cooling fins of the radiator, oil cooler, or A/C condenser with compressed air or water, be careful not to damage cooling fins which may impair cooling capabilities.

NOTE:

Failure to keep cooling systems clean can cause over heating and damage to the hydrostatic system and/or engine.

HYDRAULIC FILTER AND STRAINERS–



FIG 7.88-2

RETURN FILTER- Remove and install a new 10 micron rated return filter (fig. 7.88-2) at the end of the first 50 hours of use, subsequently replace the filter every 250 hours, or once a year, whichever comes first.

SUCTION STRAINERS– The suction strainers located inside of the tank should be examined for wear and blockage when the tank is empty for fluid service (see page 7.83).

FILL SCREEN- Replace the fill screen immediately if there is any signs of a tear or break. The screen is the first defense against foreign materials entering the tank.

VII. SERVICE AND MAINTENANCE

C. FILTERS

ENGINE LUBE FILTER— The engine lube filter (oil filter) (fig. 7.89-1) should be changed every 500 hours or anytime that the oil is changed.

The filter is located under the service platform, behind the right rear wheel. It is accessible from the ground level.



FIG 7.89-1

FUEL FILTERS AND STRAINERS

REMOTE FUEL FILTER (Water Separator) - (fig. 7.89-2, item 1) Located on the right side of the engine, this filter should be drained of the water and other deposits when prompted by the MDM. Replace the filter every 500 hours or as necessary. Note: Has a hand pump to prime fuel system.



FIG 7.89-2



FIG 7.89-3

IN LINE STRAINER- (fig. 7.89-3) Located on the right hand side of the engine, above the air filter. Note the direction of the fuel flow arrow when replacing.

PRIMARY FUEL FILTER—(fig. 7.89-4) Located near the air intake filter, this filter should be replaced every 500HRS or once a year, whichever comes first.



FIG 7.89-4

VII. SERVICE AND MAINTENANCE

C. FILTERS

OTHER STRAINERS

SOLUTION LINE “Y” STRAINER– To help maintain consistent application rates, check the solution line strainer (fig. 7.90-1) daily for blockage. Clean the strainer screen as required. Be sure to wear appropriate clothing while removing and cleaning the line strainer screen. Replace with a 50 or 80 mesh strainer screen. Confirm the gasket is in place before re-installing the screen.



FIG 7.90-1

Check all strainers occasionally for blockage and replace them if they show signs of deterioration. Refer to the Hagie Parts Manual for replacement part numbers and specific locations.

FRESH AIR CAB FILTERS

PAPER FILTER– The paper filter should be cleaned every 50 hours, or more often if necessary. Remove the paper element and gently tap it against a flat surface. Direct low pressure compressed air through the filter to remove larger particles. Replace the paper filter if necessary.

CHARCOAL FILTER– Remove and replace the charcoal filter at the first signs of chemical odor entering the cab.



FIG 7.90-3

To remove, clean, or replace the filters in the cab, undo the thumb screws on the cover (figure 7.90-2, item 1) and carefully remove the filters. Wipe the cover clean with a damp cloth and allow to dry before replacing.

Figure 7.90-3 shows the air tube that allows fresh air into the cab. Check it often for any material blocking the opening.

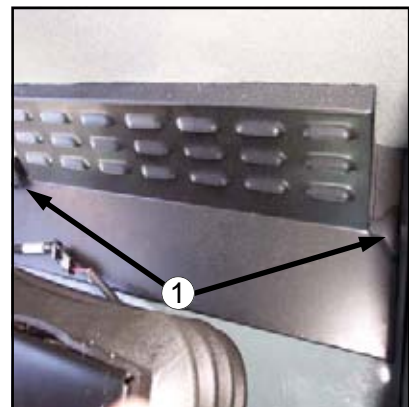

FIG 7.90-2

VII. SERVICE AND MAINTENANCE

D. LUBRICATION

LEGS AND STEERING– The front legs have a grease zerk in the tie rod ball (figure 7.91-1, item 1) that needs greased every 50 hours or weekly.



FIG. 7.91-2

Both the front and rear legs have two grease zerks, one in each of the tower bearings (figure 7.91-1, item 2) that must be greased every 50 hours or as necessary. There is a zerk in the collar (figure 7.91-1, item 3) that also needs greased every 50 hours or as necessary.

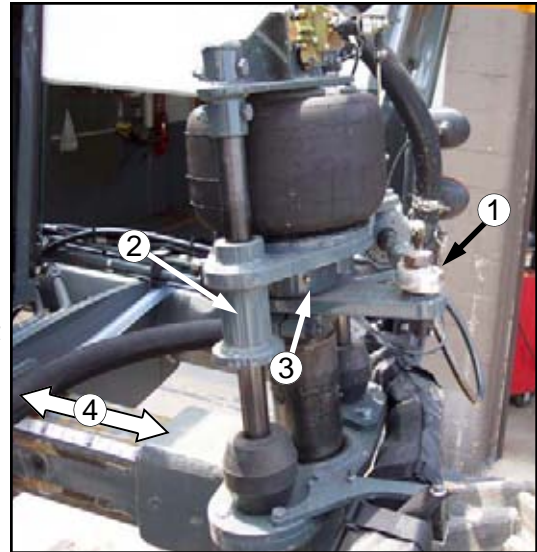

FIG. 7.91-1

The slide path of the tread adjust (figure 91-1, item 4) should be greased every 50 hours depending on the amount of usage.

Each leg also has a grease zerk on the inside of the leg (fig. 7.91-2) that should be greased every 50 hours. Tall crops may wipe away much of the grease, be sure to check each leg daily.

NOTE:
Failure to properly lube pivot points may result in unnecessary wear and damage.

NOTE:
DO NOT use air-type grease gun to lube leg towers, may result in seal distortion.

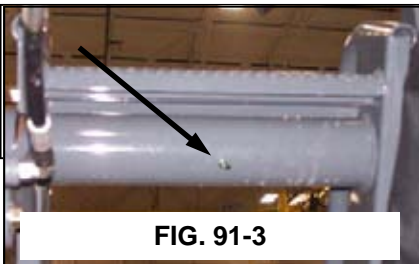

FIG. 91-3

LADDER– The ladder pivot tube (figure 7.91-3) has a grease zerk that needs to be lubed every 50 hours or as needed.

TRANSOM PIVOT TUBES– The transom pivot tube that attaches the booms to the transom has a grease zerk that should be greased every 50 hours or as needed depending on the amount of use.

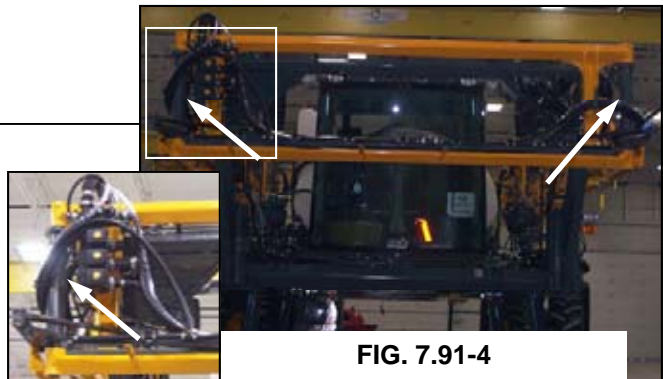

FIG. 7.91-4

VII. SERVICE AND MAINTENANCE

E. ELECTRICAL

BATTERIES

SERVICE ACCESS– The batteries are located at the rear of the machine behind the battery service access panel. (fig. 7.92-1)

CLEANING– Disconnect the battery cables from the batteries. Remove all corrosion with a wire brush or battery post brush. Wash the cable connections and battery posts with a weak solution of baking soda or ammonia. Apply dielectric or grease to prevent further corrosion. Reconnect the cables to the batteries making sure that they are tight. Clean every 100 hours.

CHARGING– To ease charging of the batteries, there is a set of auxiliary battery charging posts on the rear of the sprayer's mainframe (fig. 7.92-2). Connect your charging cables to them just as you would to the battery, positive cable to positive terminal, and negative cable to negative terminal. Keep these terminals clean and their caps in place when not in use.



FIG 7.92-1

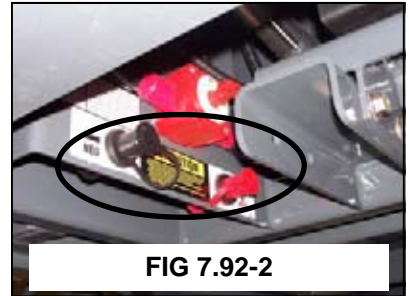

FIG 7.92-2



CAUTION

Batteries contain sulfuric acid. Avoid contact with skin, eyes, or clothing. Do not inhale fumes or ingest liquid. Batteries contain gases which can explode. Keep sparks and flame away while servicing.

Install replacement batteries with ratings equivalent to the specs below.

VOLTAGE 12 V (only)

CCA (30 sec. at 0° F)..... 950

RESERVE CAPACITY 185 min.
at 25 amps

NOTE:

To ensure the best electrical contact, battery terminal connections should be as clean and as tight as possible.

NOTE:

When servicing the electrical system always disconnect the batteries. Remove the ground cable first and connect it last.

VII. SERVICE AND MAINTENANCE

E. ELECTRICAL

CIRCUIT BREAKERS & FUSES– The GST has circuit breaker and fuse systems in various locations. Under the right hand console (fig. 7.93-1) for the cab functions, under the cab (fig. 93-2) for the light functions, and the engine compartment (fig. 7.93-3) for the engine functions.

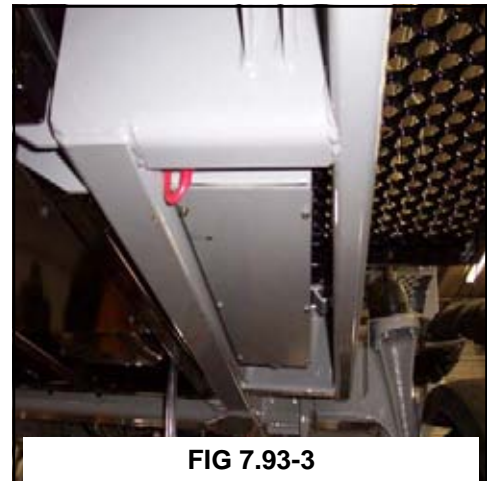
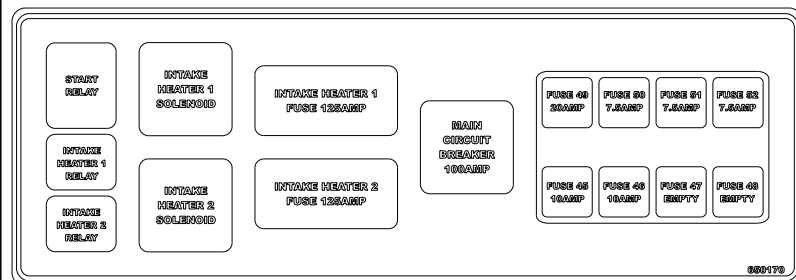
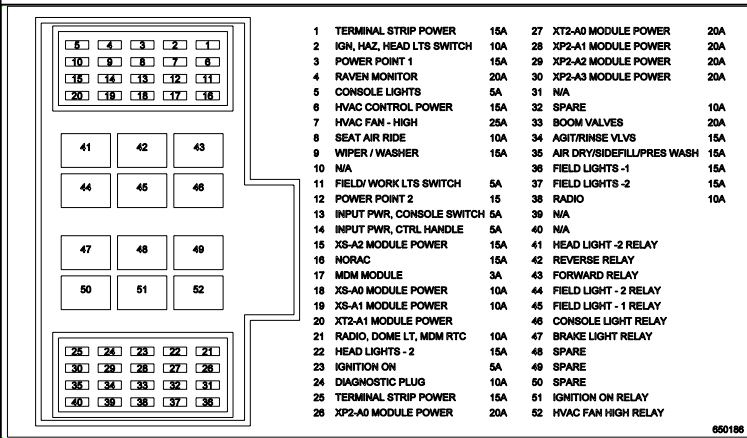

VII. SERVICE AND MAINTENANCE

F. BELTS

ENGINE DRIVE BELT

REMOVAL– Insert a 1/2 inch square ratchet drive (fig. 7.94-1) into the belt tensioner (fig. 7.94-2, item 1) and lift upward to remove the belt (fig. 7.94-2, item 2).

INSPECTION– Visually inspect the belt daily. Check the belt for intersecting cracks (fig.

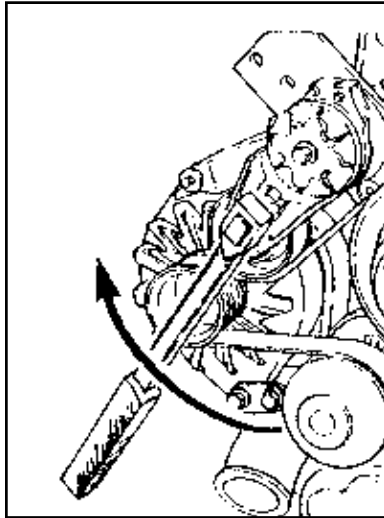

FIG 7.94-1

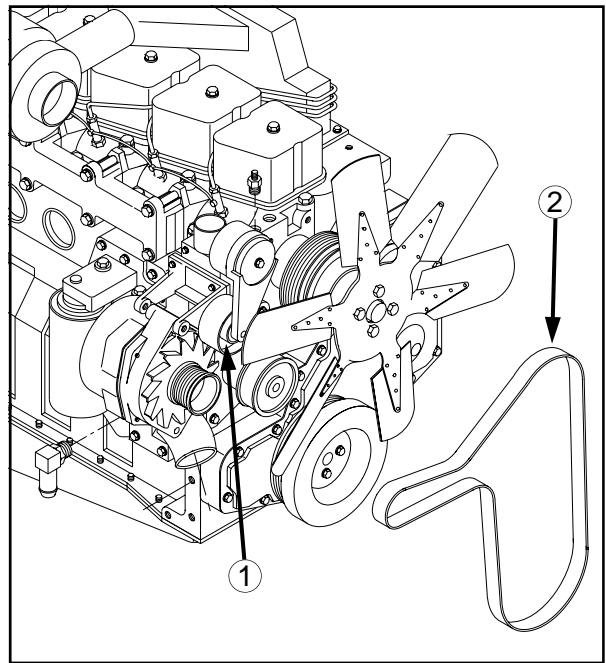

FIG 7.94-2

94-3). Transverse (across the belt width) cracks are acceptable. Longitudinal (direction of the belt length) cracks that intersect with transverse cracks are not acceptable. Replace the belt if it is frayed or has pieces of material missing.

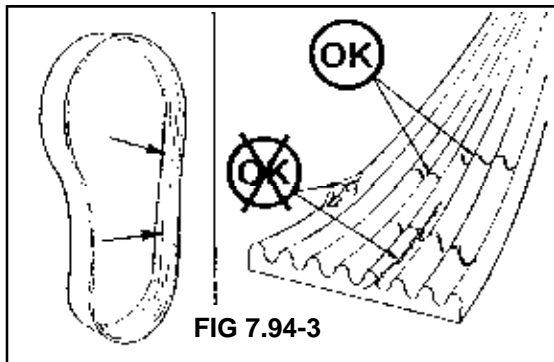

FIG 7.94-3

A/C COMPRESSOR BELT– To tighten air conditioner compressor belt, loosen the two pivot bolts (fig. 7.94-4, item 1) and the two slide bolts (fig. 7.94-4, item 2). Using a suitable prying tool, adjust tension on the belt to the desired tautness. While maintaining tension, re-tighten all four bolts. Inspect belt every 250 hours.

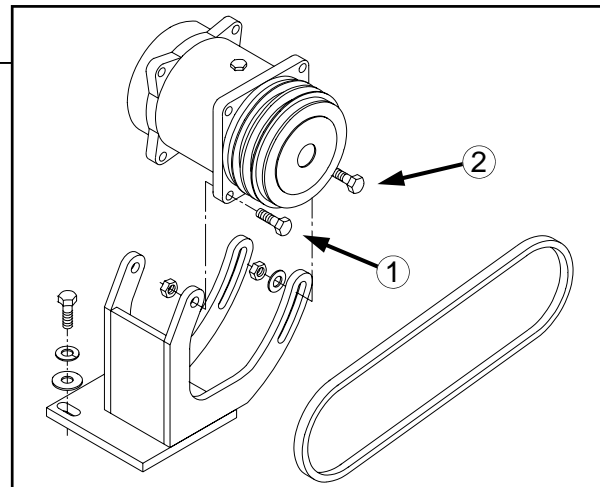

FIG 7.94-4

VII. SERVICE AND MAINTENANCE

G. BOLT TORQUE

WHEEL BOLTS– If you do not have the proper equipment to mount a tire, let your local qualified tire sales/service dealer mount the tire for you. The tire should be mounted on the rim according to figure 7.95-1 for best traction and tread cleaning action. To install wheel and tire assembly on the wheel hub lubricate studs with an anti-seize grease. Align the wheel bolt holes with the wheel hub studs and mount the wheel on the hub.

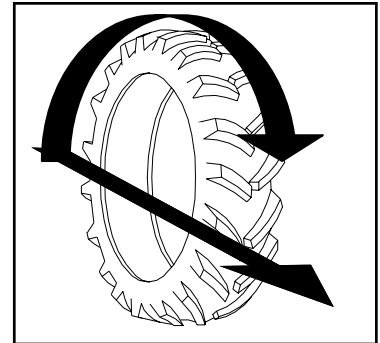

FIG 7.95-1

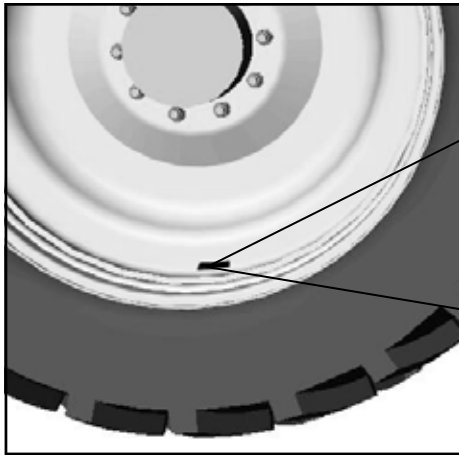

FIG 7.95-2

**Keep wheel bolts tight.
See owner's manual for
torque specifications.**

NOTE:

To achieve even torquing consistency, the tire should be completely off the ground.

Start all of the lug nuts and tighten them until they are just snug. Following the torque sequence in figure 7.95-3, first turn each lug nut to a torque value of 120 dry foot– pounds. Use slow, even pressure on the torque wrench. Quick or jerky movements cause inaccurate values. Repeat the same sequences to 150 dry foot– pounds and again finally to 400 to 500 dry foot– pounds.

If the wheel turns during lug nut torquing, lower the machine to the ground just enough for the tire to touch and prevent rotation or more preferably, place a suitable wedge between the tire and the ground.

Lower the machine and resume operation. Recheck torque after 30 minutes of operation.

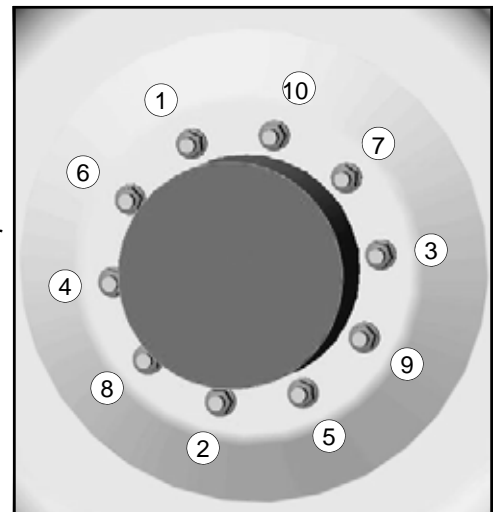

FIG 7.95-3



CAUTION

Check lug nut torque immediately after receiving machine and every 50 hours thereafter.

VII. SERVICE AND MAINTENANCE

G. BOLT TORQUE

LEG BEARING TORQUE- With the engine turned off, visually inspect the tread bearing bolts on both the bottom and the side (fig. 7.96-1) every 50 hours. Torque check them every 100 hours.

To torque check the bearing bolts:

1. Loosen the jam nut (fig. 7.96-1, item 2) on each bearing bolt.
2. Using an "X" pattern (fig. 7.96-2) verify current torque on each bolt (fig. 7.96-1, item 1) is equivalent to last check from 100 hours previous. Repeat torque pattern a second time.
3. Then increase the torque two foot pounds on each bolt using the "X" pattern and retighten each jam nut.

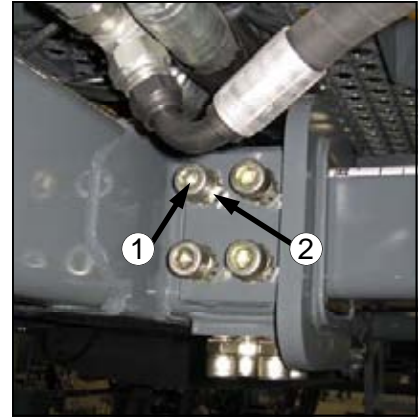

FIG 7.96-1

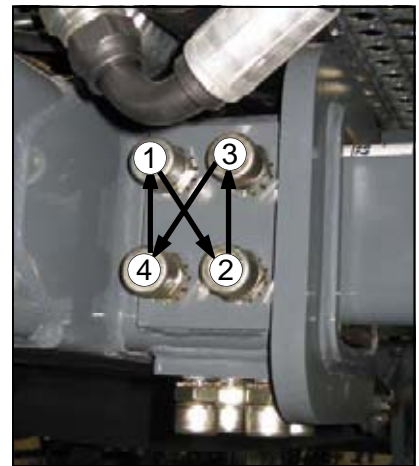

FIG 7.96-2

VII. SERVICE AND MAINTENANCE

H. TOE-IN

GAUGING TOE-IN- To correctly gauge toe-in, phase the cylinders first. To phase the cylinders, while driving slowly forward, turn the wheels all the way one direction until the steering cylinder bottoms out, continue to turn to allow fluid to bypass the cylinder. Then repeat going to the other direction. Then use a tape measure placed at one-half the height on the front center seam of the front tire compared to the same measurement of the rear of the front tire (subtract the front measurement from the rear measurement—it must be a positive number). Correct toe-in should fall between one half and three quarters of an inch.

Toe-in is preset at the factory and should not have to be adjusted unless the steering cylinders are removed.

Difficulty steering one way versus the other or “darting” during operation, may indicate incorrect toe-in and may require adjustment.

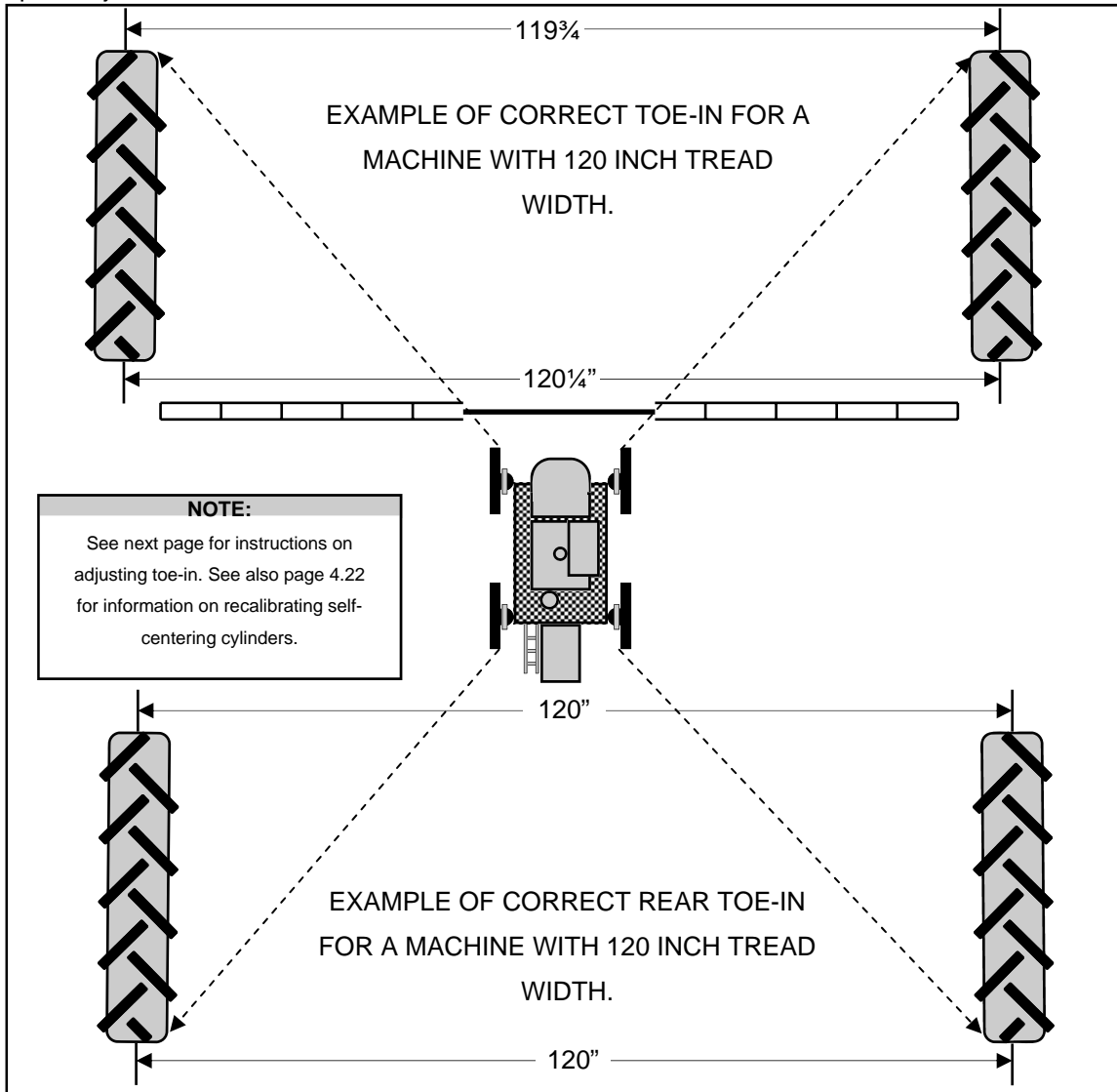

FIG 97-1

VII. SERVICE AND MAINTENANCE

H. TOE-IN

TOE-IN ADJUSTMENT– To adjust toe-in of the front tires follow these instructions for both front steering cylinders carefully:

1. Phase the cylinders (previous page), stopping at “center” .
2. Loosen jam nut (fig. 7.98-1).
3. Screw swivel assembly in or out on steering cylinder until the measurement from the center of the rod end to the collar (fig. 7.98-1, item 2) is the same on both of the front steering cylinders.

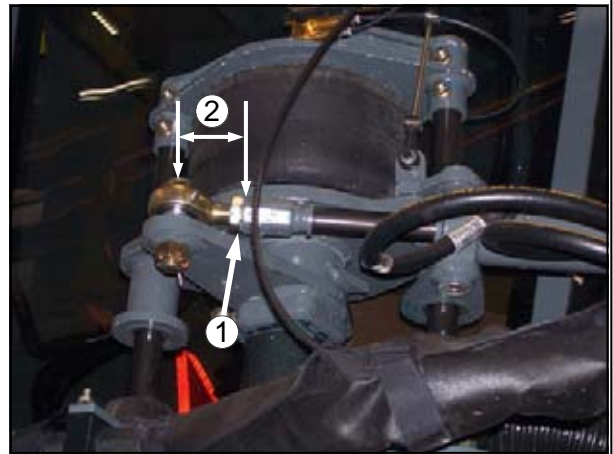

FIG 7.98-1

4. Tighten jam nut.
5. Phase cylinders again, re-check toe-in measurement. The cylinders must be phased anytime an adjustment is made to the cylinders.
6. Drive forward 30-50 feet and re-measure.
7. Repeat steps 2-6 until a correct toe-in measurement is reached.

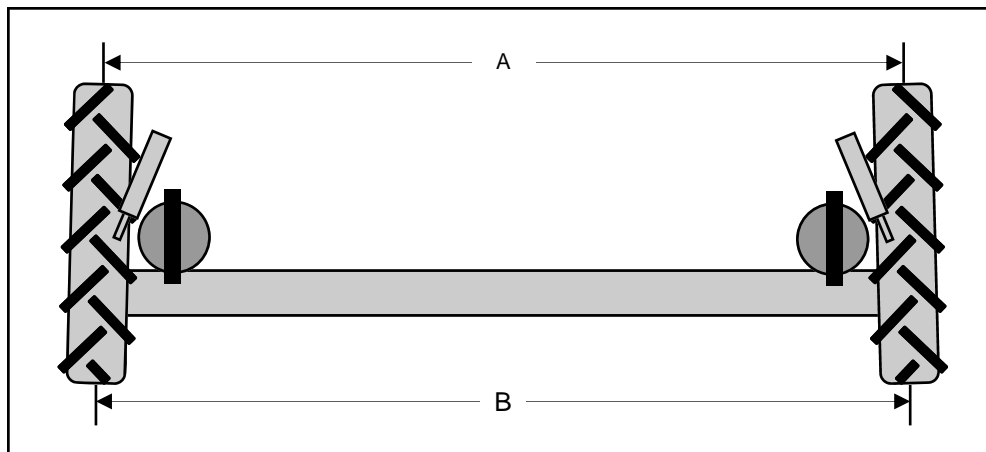

FIG 7.98-2

NOTE:

Dimension “A” should be $\frac{1}{2}$ " to $\frac{3}{4}$ " less than dimension “B.” For more information regarding toe-in, see page 97.

VII. SERVICE AND MAINTENANCE

I. AIR PRESSURE



FIG 7.99-1

AIR BAG PRESSURE– The airbags (fig. 7.99-1) automatically adjust pressure to compensate for load weight and field conditions. The system includes an air dryer (fig. 7.99-2) that dries the air coming from the air compressor before sending it to a collection tank. Check the dryer cartridge every 50 hours to make sure that it is purging with compressor unload. Change the cartridge as needed or every other season (1000 hours).



FIG 7.99-2

From the collection tank, the air is sent to the airbags located on the legs (fig. 7.99-1) as needed to maintain a level pressure. There are control valves on each leg that open and close to allow air in.

Visually check the air bags daily for leaks and cracking. If an air bag seems to be low check the bag for any punctures or leaks. Call Hagie Customer Service for repairs.



FIG 7.99-3

WET TANK– Drain the wet tank (fig. 7.99-3) daily to prevent system condensation from contaminating the engine air compressor or dryer.

AIR TANK– Drain the air tank (fig. 7.99-4) daily by slowly releasing the drain cock. Check for moisture in the system. If there

is excessive moisture in this tank, there may be a problem with the system. Call Hagie Customer Support for assistance.

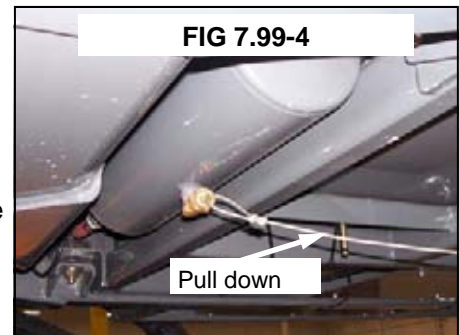

FIG 7.99-4

TIRE PRESSURE– Check the pressure once a week or every 50 hours of operation (fig. 99-5). Never inflate a tire more than the recommended maximum air pressure. Use an air line with a locking air chuck and stand behind the tire tread while filling (fig. 7.99-6).



FIG 7.99-5



FIG 7.99-6

NOTE:

Tire pressure will depend on tire type and load quantity in solution tanks. Refer to page 3.7 for tire specifications.



WARNING

When inflating tire use extension hose with in-line air gauge and clip-on air chuck, which allow operator to stand clear of tire side wall explosion trajectory.

VII. SERVICE AND MAINTENANCE

J. SPRAY SYSTEM

SPRAY TIPS– At the beginning of each season, or as required, remove a random sample of spray tip caps (fig. 7.100-3, item 3) and inspect the nozzle tips. If they are plugged or worn, clean or replace them. **DO NOT** put your mouth to a spray tip to try to unplug it!

NOZZLE DIAPHRAGMS– At the beginning of each season, remove each nozzle body cap (fig. 7.100-3, item 1) and inspect the diaphragm (fig. 7.100-3, item 2) for wear or fit. Replace if necessary. Refer to accompanying manual containing nozzle information.

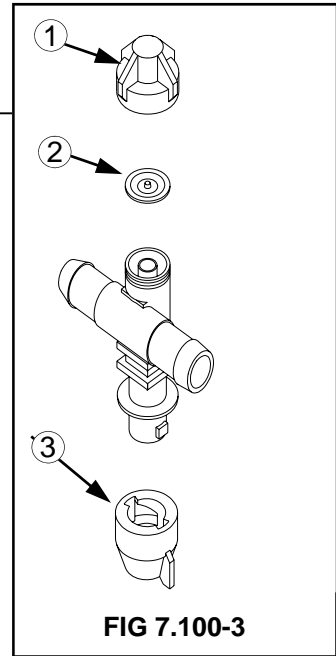

FIG 7.100-3

VIII. STORAGE

A. PREPARING FOR STORAGE

1. Perform daily level checks, lubrication, and bolt and linkage inspections as required in this manual in section five on maintenance.
2. Every other season, drain the coolant from the engine and radiator. Probe the drain holes during draining to ensure they are not clogged by sludge, scale, or other deposits. Fill the cooling system to the top with a 50/50 water/ antifreeze mixture. Run the engine to operating temperature and re-check the level.
3. Add a fuel stabilizer to the fuel and fill the tank.
4. Run the engine until it is at operating temperature, then drain the engine oil. Refill with fresh oil of recommended weight and install a new lubricating oil filter element.
5. With the engine at normal operating temperature, cycle all hydraulic functions including the steering.
6. Release tension on all belts.
7. Use plastic bags and water resistant adhesive tape to seal the air intake opening, all exhaust manifold openings, engine oil filter cap, hydraulic oil tank breather cap, and fuel tank caps.
8. Disconnect and remove batteries. Completely clean and charge the batteries. Coat the terminals with dielectric grease and store the batteries in a cool, above freezing place.
9. Thoroughly clean the sprayer. Touch up any painted surfaces that are scratched or chipped. For touch up paint recommendations contact the Hagie Manufacturing Customer Support Department.
10. Replace worn or missing decals. See Section 1 for proper location of warning decals and their corresponding part number. Warning decals and all other Hagie decals are available through the Hagie Customer Support Department.
11. Use a multi-purpose grease to coat exposed hydraulic cylinder rods.
12. To winterize the spray system, it is recommended that you use an environmentally safe type antifreeze and water mixture that will give you adequate protection to minus 30 degrees below zero. Drain any remaining solution in the spray system and run the antifreeze mixture through the spray system until it comes out all boom openings. Repeat the above process with both the foam marker and rinse systems.
13. Refer to the Raven manual for detailed information on storage procedures for the monitor and flow meters.
14. If the sprayer must be stored outside, cover it with a waterproof cover.

NOTE:

If antifreeze is added, make sure the engine is then run to operating temperature to assure proper mixing of solution.

NOTE:

For replacement decals contact:
Hagie Manufacturing Company
721 Central Ave. West
Box 273
Clarion, IA 50525-0273
Ph. 1-800-247-4885

VIII. STORAGE

B. REMOVING THE GST FROM STORAGE

1. Inspect the condition, and test the air pressure of all the tires.
2. Carefully unseal all openings that were sealed in the storage process.
3. Clean and reinstall the batteries. Be sure to attach the battery cables to the proper terminals.
4. Tighten all belts. Inspect and replace any worn belts.
5. Check the engine oil, hydraulic oil, and engine coolant levels; add if necessary. A mixture of 50/50 anti-freeze and water will cool adequately in summer as well as protect in winter.
6. Completely clean the sprayer.
7. Review section five on maintenance and perform all needed services as instructed.
8. For starting instructions, refer to Section 4 on operating information.

NOTE:

Protective compounds such as grease can harden under exposure to weather conditions. Be sure to remove any dried grease and re-apply new if necessary.

NOTE:

See Warranty on page 112 concerning **improper storage**.

IX. TROUBLE SHOOTING

A. ENGINE



Start engine from operator's seat only. When running engine in a building, be sure there is adequate ventilation.

PROBLEM	POSSIBLE CAUSE	SUGGESTED REMEDY
Engine won't crank	<ul style="list-style-type: none"> • Dead battery • Poor battery connections • Starter or starter relay • Blown fuse in engine electric box • Battery switch in OFF position 	<ul style="list-style-type: none"> • Recharge or replace battery • Clean and tighten • Test; rebuild or replace • Check 20 amp fuse • Turn battery switch to ON position
Engine won't start	<ul style="list-style-type: none"> • Out of fuel • Clogged fuel filter • Cold weather • Low starter speed • Blown fuse in engine electric box 	<ul style="list-style-type: none"> • Fill fuel tank • Replace fuel filters • Refer to engine manual for cold weather starting • Check starter and battery • Check 20 amp fuse
Engine overheats	<ul style="list-style-type: none"> • Engine overloaded • Dirty radiator core or dirty grill screen • Faulty radiator cap • Loose or faulty fan belt • Faulty thermostat • Low coolant level 	<ul style="list-style-type: none"> • Reduce load • Remove all foreign material and clean all items • Replace cap • Tighten or replace fan belt • Replace thermostat • Refill to proper level with recommended coolant

IX. TROUBLE SHOOTING

A. ENGINE



Start engine from operator's seat only. When running engine in a building, be sure there is adequate ventilation.

PROBLEM	POSSIBLE CAUSE	SUGGESTED REMEDY
Engine misfires: runs uneven, low power	<ul style="list-style-type: none">• Water in fuel• Dirty air cleaner element• Poor grade of fuel• Fuel tank vent clogged• Clogged fuel filter	<ul style="list-style-type: none">• Drain, flush, replace filter, fill system• Replace element• Drain system, change to a better grade fuel• Open fuel tank vent in cap• Replace fuel filter
Engine knocks	<ul style="list-style-type: none">• Low oil level in crankcase• Cold engine	<ul style="list-style-type: none">• Add oil to full mark• Allow proper warm-up period; refer to engine owner's handbook

IX. TROUBLE SHOOTING

B. SPRAY SYSTEM



WARNING

CHEMICALS ARE DANGEROUS

Read The Chemical manufacturer's labels to avoid injury or damage.

PROBLEM	POSSIBLE CAUSE	SUGGESTED REMEDY
Solution pump will not prime	<ul style="list-style-type: none"> • Low water level in pump • Air leak in suction line • Solution tank valve closed 	<ul style="list-style-type: none"> • Make sure the solution tank is not empty, solution pump is self-priming • Inspect and tighten all fittings on suction line • Open solution tank valve, allow air to leave the system
Erratic reading on pressure gauge	<ul style="list-style-type: none"> • Orifice in back of gauge clogged • Faulty gauge • Air leak in suction line • Glycerin leaking from gauge 	<ul style="list-style-type: none"> • Remove gauge; clean orifice; reinstall • Replace gauge • Inspect and tighten all fittings in suction line • Replace gauge
Malfunction of electric solution valve	<ul style="list-style-type: none"> • Faulty ground • Dirty contact terminals • Separation in wire • Faulty switch • Short in solenoid coil • Bad valve 	<ul style="list-style-type: none"> • Clean and tighten ground • Clean contact terminals • Check continuity and replace wire • Replace switch • Replace valve • Replace valve

IX. TROUBLE SHOOTING

B. SPRAY SYSTEM

NOTE:

If your unit is equipped with a high-pressure system, call the Hagie Manufacturing Customer Support Department for possible causes and suggested remedies.

PROBLEM	POSSIBLE CAUSE	SUGGESTED REMEDY
Solution pump not producing normal pressure	<ul style="list-style-type: none"> • Clogged line strainer screen • Air leak in suction flow to pump • Restricted solution flow to pump • Suction hose collapsed • Internal restriction of diaphragm such as build up of chemical • Hydraulic failure 	<ul style="list-style-type: none"> • Remove screen; clean thoroughly; tighten strainer cap to avoid air leak • Inspect and tighten all fittings on suction line • Main solution tank shut-off valve not completely open • Obstruction at inlet end of hose causing high vacuum on hose • Disassemble; inspect; clean; reassemble • Call Hagie Customer Service

NOTE:

Refer to the Raven installation and operation manual for trouble shooting guide on Raven monitor and system

IX. TROUBLE SHOOTING

C. HYDROSTATIC SYSTEM



PROBLEM	POSSIBLE CAUSE	SUGGESTED REMEDY
Machine won't move in either direction	<ul style="list-style-type: none"> • Cruise is set too low • Engine speed too low • Oil level in reservoir too low • Clogged filter • Hydrostatic system failure 	<ul style="list-style-type: none"> • Adjust the knob for cruise • Set engine at operating RPM before trying to move machine • Fill reservoir to proper level with approved oil; see section on service and maintenance • Replace filter • Call Hagie Customer Service

IX. TROUBLE SHOOTING

C. HYDROSTATIC SYSTEM



PROBLEM	POSSIBLE CAUSE	SUGGESTED REMEDY
Machine will move in only one direction	<ul style="list-style-type: none"> • Cruise is set too low • Hydrostatic system failure 	<ul style="list-style-type: none"> • Adjust the cruise knob • Call Hagie Customer Support
Hydrostatic system responding slowly	<ul style="list-style-type: none"> • Engine speed too low • Oil in reservoir low • Cold oil • Plugged filter • Partially restricted suction line 	<ul style="list-style-type: none"> • Set engine at operating RPM before trying to move machine • Fill reservoir to proper level with approved oil; see section on service and maintenance • Allow adequate warm up period • Check and replace filter • Inspect for collapsed suction hose
Noisy hydrostatic system	<ul style="list-style-type: none"> • Cold oil • Low engine speed • Oil level in reservoir low • Hydrostatic system failure 	<ul style="list-style-type: none"> • Allow adequate warm up period • Increase engine speed • Fill reservoir to proper level with approved oil; see section on service and maintenance • Call Hagie Customer Service

IX. TROUBLE SHOOTING

D. HYDRAULIC SYSTEM



PROBLEM	POSSIBLE CAUSE	SUGGESTED REMEDY
Entire hydraulic system fails to function	<ul style="list-style-type: none"> • Oil level in reservoir too low • Auxiliary hydraulic system failure 	<ul style="list-style-type: none"> • Fill reservoir to proper level with approved oil; see section on service and maintenance • Call Hagie Customer Service
Noisy hydraulic pump	<ul style="list-style-type: none"> • Oil level in reservoir too low • Auxiliary hydraulic system failure 	<ul style="list-style-type: none"> • Fill reservoir to proper level with approved oil; see section on service and maintenance • Call Hagie Customer Service

NOTE:

Refer to the Raven installation and operation manual for trouble shooting guide on Raven monitor and system

IX. TROUBLE SHOOTING

E. ELECTRICAL

 **CAUTION**
 Batteries contain sulfuric acid. Avoid contact with skin, eyes, or clothing. Do not inhale fumes or ingest liquid. Batteries contain gases which can explode. Keep sparks and flame away while servicing.

NOTE:
 Disconnect battery when servicing any part of electrical system to prevent system damage.

PROBLEM	POSSIBLE CAUSE	SUGGESTED REMEDY
Entire electrical system is dead	<ul style="list-style-type: none"> • Dead battery • Poor battery connection • Low charging rate • No charging rate • Battery master switch is in OFF position 	<ul style="list-style-type: none"> • Replace battery • Clean and tighten battery connections • Tighten alternator belt • Replace alternator • Turn battery master switch to ON position
Light system does not function	<ul style="list-style-type: none"> • Poor ground • Burned out bulb • Separation or short in wire • Blown fuse • Faulty switch • Ignition switch is off 	<ul style="list-style-type: none"> • Clean and tighten ground • Replace bulb • Check continuity and replace wire • Replace fuse • Replace switch • Turn ignition switch to ON position

NOTE:
 Refer to the Raven installation and operation manual for trouble shooting guide on Raven monitor and system

IX. TROUBLE SHOOTING

NOTES

X. LIMITED WARRANTY

Hagie Manufacturing Company Product Warranty

Hagie Manufacturing Company warrants each new Hagie (including Vammas by Hagie) product to be free under normal use and service from defects in workmanship and materials for a period of lesser of: two (2) years or 1000 hours from the date of delivery on all Agricultural Products and two (2) years or 2000 hours on all Vammas By Hagie Snow Removal Equipment (SRE). Hagie Manufacturing Company makes this warranty from the original delivery date and is transferable to a purchaser from the original purchaser of this equipment, given there is remaining time left under the year and hour warranty standard stated above. This warranty shall be fulfilled by repairing or replacing free of charge any part that shows evidence of defect or improper workmanship, provided the part is returned to Hagie Manufacturing Company within thirty (30) days of the date that such defect or improper workmanship is discovered, or should have been discovered. Labor to repair said items will be covered by standard labor time rates. Freight charges of defective parts are not covered by this warranty and are the responsibility of the purchaser. No other express warranty is given and no affirmation of Hagie Manufacturing Company, by words or action, shall constitute a warranty.

Hagie Manufacturing Company limits its warranty to only those products manufactured by Hagie Manufacturing Company (including Vammas by Hagie) and does not warrant any part or component not manufactured by Hagie Manufacturing Company (including Vammas by Hagie), such as parts or components being subject to their manufacturer's warranties, if any. Excluded from this warranty are parts subjected to accident, alteration, or negligent use or repair. This warranty does not cover normal maintenance such as engine tune ups, adjustments, inspections, nor any consumables such as tires, rubber products, solution system valves, wear parts, wiper blades, etc.

Hagie Manufacturing Company shall not be responsible for repairs or replacements which are necessitated, in whole or in part; by the use of parts not manufactured by or obtainable from Hagie Manufacturing Company nor for service performed by someone other than Hagie authorized personnel, unless authorized by Hagie Manufacturing Company. Customer acknowledges that it is not relying on Hagie Manufacturing Company's skill or judgment to select finish goods for any purpose and that there are no warranties which are not contained in this agreement.

In no event shall Hagie Manufacturing Company's tort, contract, or warranty liability exceed the purchase price of the product. The foregoing limitation will not apply to claims for personal injury caused solely by Hagie Manufacturing Company's negligence.

Hagie Manufacturing Company shall not be liable for damages, including special, incidental or consequential damages or injuries (damage and repairs of equipment itself, loss of profits, rental or substitute equipment, loss of good will, etc.) arising out of or in connection with performance of the equipment or its use by customer, and Hagie Manufacturing Company shall not be liable for any special, incidental or consequential damages arising out of or in connection with Hagie Manufacturing Company's failure to perform its obligation hereunder. HAGIE MANUFACTURING COMPANY'S ENTIRE LIABILITY AND THE CUSTOMER'S EXCLUSIVE REMEDY SHALL BE REPAIR OR REPLACEMENT OF PARTS COVERED UNDER THIS WARRANTY. THIS WARRANTY IN LIEU OF ALL OTHER WARRANTIES, EXPRESSED OR IMPLIED, INCLUDING, BUT NOT LIMITED TO THE IMPLIED WARRANTY OF MERCHANTABILITY OR FITNESS FOR A PARTICULAR PURPOSE.

INDEX

	PAGE	PAGE
A		
ACE: Automatically Controlled Engine	40	
Agitation	53	
Switch	26	
Air Conditioning System		
Belt	94	
Charging System	84	
Climate Controls	30	
Vents ..	31	
Air Dryer Cartridge	99	
Air Pressure	99	
Air Bag Suspension	99	
Tire Pressure	99	
Air Ride Seat	34	
Air Tank	99	
Airbags	99	
Antifreeze	85	
Auxiliary Hydraulic System	41	
Specifications	17	
B		
Batteries	92	
Charging Auxiliary Posts	92	
Disconnect	36	
Service Access	92	
Belts	94	
Engine	94	
Removal.....	94	
Inspection	94	
A/C Compressor	94	
Bolt Torque®	95	
Leg Bearing Torque	96	
Wheel Bolts	95	
Boom		
Boom Extension Switch	26	
Boom L.E.D. Indicators	55	
Boom Solution Valve Switch	26,55	
Configuring 80' to 90'	49	
Cradling.....	75	
Operation	44-49	
Stands	58	
Brush Control	25,42	
Buddy Seat	34	
C		
Cab	21-34	
Filters ..	90	
Charcoal Filter	90	
Fresh Air Intake Filter	90	
Front Console	21-23	
Hazard/ Warning Lights	21	
Highway Lights/ Running Lights	22	
Ignition Switch.....	23	
Steering Column Release Pedal.....	23	
Tilt Adjust Handle.....	23	
Turn Signals.....	22	
Side Console	24-27	
Agitation Switch	26	
Boom Extension Switch	26	
Boom Valve Section Switch.....	26	
Brush Control.....	25	
Float Switch	26	
Forward Control.....	27	
Horizontal Fold.....	27	
Hydrostatic Lever.....	25	
Level	27	
Lift	27	
Main Solution Switch	27	
Neutral Control.....	27	
Parking Brake	25	
Power Ports	27	
Reverse Control.....	27	
Tank Switch	26	
Throttle Switch	25	
Work Mode Switch.....	26	
Other Features.....	32-34	
Air Ride Seat.....	34	
Buddy Seat	34	
Cab Filters	33	
Cab Glass	33	
Interior Lights	32	
Rear Viewing Mirrors	31	
Res-Q-Me Tool/ Emergency Exit.....	33	
Overhead Controls and Monitors.....	28-31	
Climate Controls	30	
Edge Plow Controls Decal.....	31	
Field Lights and Work Lights	30	
Hagie Diagnostic Port.....	28	
MDM	29	
Raven Spray Systems Console.....	31	
Spray System Indicator Light.....	29	
Vents.....	31	
Warning Indicator Light.....	28	
Windshield Wiper and Washer Fluid Switches	29	
Specifications.....	19	
Calibration	64-74	
Programming Raven Console.....	67-74	
Circuit Breakers	93	
Cold Weather Start-up Procedure	38-39	
Cooling System		
Coolant.....	85	
Radiator Grille Screen.....	88	
D		
Decals		
Location	8-12	
Edge Plow Controls Decal	31	
Deluge System	29,86	
E		
Edge Plow Controls Decal	31	
Electrical System	92-93	
Batteries.....	92	
Charging Auxiliary Posts.....	92	

INDEX

	PAGE		PAGE
Service Access	92	Remote Fuel Filter	89
Circuit Breakers	93	Fuses	93
Specifications	18-19		
Circuit Breakers/Fuses	18-19	G	
General Electric System	18	Glass (cab)	33
Lights	19	Grease Zerk s	91
Emergency Exit (Res-Q-Me Tool)	33		
Engine	35	H	
Air Intake Filter	87	Hazard/ Warning Lights	21
Cold Weather Start-up Procedure	38-39	Highway Lights/ Running Lights	22
Drive Belt	94	Horizontal Boom Fold	27, 47
Exhaust Brake	78	Hydraulic Pump	42
Fuel	86	Oil Level	83
In Line Strainer	89	Oil Type	83
Primary Fuel Filter	89	Hydraulic System	41-49
Remote Fuel Filter	89	Auxiliary	17, 41
Oil	83	Brush Control	25, 42
Filter	89	Horizontal Boom Fold	47
Operation	35-39	Hydraulic Pump	42
Specifications	16	Ladder	43
		Level	46
F		Lift	46
Filter Minder ®	87	Manually Folding boom	49
Filters	87-90	Power Steering System	42
Engine Air Intake Filter	87	Solution Pump	42
Engine Oil Filter	89	Spray Booms	44
Filter Minder®	87	Vertical Extension Fold	48
Fresh Air Cab Filters	90	Hydrostatic Drive System	35-40
Fuel Filters	89	ACE: Automatically Controlled Engine	40
Hydraulic High-Pressure In-Line Filter	88	Battery Disconnect	36
Hydraulic Suction Filters	88	Cold Weather Start-up Procedure	38-39
Solution Line Strainer	90	Cummins Engine	35
Radiator Grille Screen	88	Operating the Engine	36-39
Float Switch	26	Parking Brake	37
Flow Meter	53	Pre-operational Checks	36
Fluids	83-86	Specifications	16
Air Conditioning Charge	84	Starting the Engine	37
Capacities	20	Tandem Pump	35
Cooling System Coolant	85	Wheel hubs	35
Engine Oil	83	Wheel Motors	35
Fuel	86	Hydrostatic Lever	25
Hydraulic Oil	83	Forward Control	27
Wheel Hub Oil	84	Horizontal Fold	27
Windshield Washer	86	Level	27
Forward Control	27	Lift	27
Fresh Air Cab Filters	90	Main Solution Control	27
Front Console	21-23	Neutral Position	27
Hazard/ Warning Lights	21	Reverse Control	27
Highway Lights/ Running Lights	22	Throttle Switch	25
Ignition Switch	23		
Steering Column Release Pedal	23	I	
Tilt Adjust Handle	23	Identification numbers	13-14
Turn Signals	22	Engine	13
Fuel	86	Front Wheel Motors	14
Filter	89	Hydrostatic Pumps	14
In Line Strainer	89	Rear Wheel Motors	14
Fuel Filter (water separator)	89	Sprayer	13

INDEX

	PAGE		PAGE
Wheel Hubs	14	Buddy Seat	34
Ignition Switch	23	Cab Filters	33
Interior Lights	32	Cab Glass	33
		Climate Controls	30
J, K		Edge Plow Controls Decal	31
		Field Lights	30
L		Float Switch	26
Ladder	43	Forward Control	27
Lubrication	91	Hagie Diagnostic Port	28
L.E.D. Indicators		Hazard/Warning Lights	21
Boom Solution Valve	55	Highway Lights/Running Lights	22
Leg Bearing Bolt Torque	96	Horizontal Fold Control	27
Level	27, 46	Hydrostatic Lever	25
Lift	27, 45	Ignition Switch	23
Lights		Interior Lights	32
Field Lights	30	Level Control	27
Hazard/Warning Lights	21	Lift Control	27
Highway Lights	22	Main Solution Switch	27
Running Lights	22	MDM	29
Turn Signal	22	Neutral Control	27
Work Lights	30	Parking Brake	25
Limited Warranty	10.1	Power Ports	27
Lock Assembly	59	Raven Spray System Console	31
Lubrication	91	Rear Viewing Mirrors	31
Grease Zerks	91	Res-Q-Me Tool/Emergency Exit	33
Ladder	91	Reverse Control	27
Legs and Steering	91	Spray System Indicator Light	29
Transom Pivot Tubes	91	Steering Column Release Pedal	23
Lug Nuts	95, 100	Tank Switch	26
		Throttle Switch	25
M		Tilt Adjust Handle	23
Main Solution Switch	27, 55	Turn Signals	22
Maintenance Schedule	78-100	Vents	31
Manual Fold (90° to 80°)	49	Warning Indicator Light	28
MDM	29	Washer Fluid Switch	29
		Windshield Wiper Switch	29
N		Work Lights	30
Neutral Position	27	Work Mode Switch	26
Nozzle Diaphragms	100	Hydraulic System	41-49
		Auxiliary Hydraulic System	41
O		Brush Control	42
Operating the Engine	36	Horizontal Boom Fold	47
ACE: Automatically Controlled Engine	40	Hydraulic Pump	42
Battery Disconnect	36	Ladder	43
Cold Weather Start-up Procedure	38-39	Manually Folding Boom	49
Parking Brake	37	Level	46
Pre-operational Checks	36	Lift	45
Starting the Engine	37	Power Steering System	42
Operating Information	21-63	Solution Pump	42
Cab	21-34	Spray Booms	44
Air Ride Seat	34	Vertical extension Fold	48
Agitation Switch	26	Hydrostatic Drive System	35-40
Boom Extension Switch	26	ACE: Automatically Controlled Engine	40
Boom Valve Section Switch	26	Battery Disconnect	36
Brush Control	25,42	Cold Weather Start-up Procedure	38-39
		Cummins Engine and Tandem Pump	35
		Parking Brake	37
		Pre-operational Checks	36

INDEX

	PAGE		PAGE
Starting the Engine	37		
Wheel Motors and Hubs	35		
Quick Attach System	56-63		
Detaching.....	56-60		
Reconnecting.....	61-63		
Spray System	50-55		
Agitation	53		
Boom Section L.E.D. Indicators.....	55		
Boom Solution Valve Switches	55		
Flow Meter	53		
Instructions	50		
Main Solution Switch	55		
Rinse System Operation.....	54		
Side-fill Operation	54		
Solution Pressure Gauge.....	53		
Solution Pump	52		
Solution Tank.....	52		
Solution Tank Valve.....	52		
Overhead Controls and Monitors	28-31		
Climate Controls	30		
Field Lights and Work Lights	30		
Hagie Diagnostic Port	28		
MDM	29		
Raven Spray Systems Console.....	31		
Spray System Indicator Light.....	29		
Vents.....	31		
Warning Indicator Light.....	28		
Windshield Wiper and Washer Fluid Switches	29		
		P	
Parking Brake	25,37		
Power Ports	27		
Power Steering	42		
Power Train			
Specifications.....	16		
Brakes			
Drive			
Steering System			
Pre-operational Checks	36		
Pressure Gauges			
Solution Spray System Pressure	53		
		Q	
Quick Attach System	56-63		
Detaching	56-60		
Reconnecting	61-63		
		R	
Radiator Grille Screen	88		
Raven Console	31		
Calibration	64-74		
Rear Viewing Mirrors	31		
Res-Q-Me Tool/Emergency Exit	33		
Reverse Control	27		
Rinse	54		
		S	
Safety Precautions	4-7		
Chemical Handling Safety.....	7		
Driving Safety.....	4		
General Safety	7		
Operating Safety	5		
General Operation Safety			
Sprayer Booms			
Tread Width			
Repair/Maintenance Safety.....	6		
Fueling			
General Repair/ Maintenance			
Hydraulics			
Seat			
Air Ride Seat	34		
Buddy Seat.....	34		
Serial Number Location			
Engine	13		
Hydrostatic Pumps	14		
Sprayer.....	13		
Wheel hubs			
Front.....	14		
Rear	14		
Wheel motors			
Front.....	14		
Rear	14		
Service/Maintenance	78-100		
Service Point Quick Reference	78		
Intervals.....	79-82		
Side-fill Operation	54		
Solution Line Strainer	90		
Solution Pressure Gauge	53		
Solution Pump	42, 52		
Solution Tank	52		
Solution Tank Valve	52		
Specifications	15-20		
Auxiliary Hydraulic System.....	17		
Cab and Instruments.....	19		
Capacities	20		
Electrical System.....	18-19		
Circuit Breaker and Fuses	18-19		
General Electrical System.....	18		
Lights	19		
Other Fuses and Relays	19		
Engine	16		
General Sprayer Information.....	15		
Power Train.....	16		
Brakes.....	16		
Drive.....	16		
Steering System.....	16		
Spray System.....	17		
Booms.....	17		
General Spray System.....	17		
Solution Fill Connection	17		
Solution Tank.....	17		
Sprayer Dimensions.....	15		
Tires	20		

INDEX

	PAGE	PAGE	
Spray Booms	44	Towing	77
Configuring 80' to 90'	49	Trouble Shooting Guide	103-111
Cradling	75	Electrical	110
Operation	45-49	Engine	103-104
Spray System	50-55	Hydraulic System	109
Agitation	53	Hydrostatic System	107-108
Boom L.E.D. Indicators	55	Notes	111
Boom Solution Valve Switches	55	Spray System	105-106
Flow Meter	53	Turn Signals	22
Instructions of Operation	50		
Introduction	50	U, V	
Main Solution Switch	55	Vertical Extension Fold	48
Rinse System	54		
Side-fill Operation	54	W	
Solution Pressure Gauge	53	Warning Symbol Definitions	2
Solution Pump	52	Warranty	112
Solution Tank	52	Wet Tank	99
Solution Tank Valve	52	Wheel Lug Nuts	95
Specifications	17	Wheel Hubs	35
Booms		Maintenance	
General Spray System		Oil	84
Solution Fill Connection		Torque Value	95
Solution Tank		Specifications	16
Spray Tips	100	Wheel Motors	35
Sprayer		Specifications	16
Dimensions	15	Windshield Washer/Wiper	29
General Sprayer Information	15	Fluid	86
Starting the Engine	37		
Cold Weather Start-up Procedure	38-39	X, Y, Z	
Steering Column Release Pedal	23		
Storage	101-102		
Suspension	99		
Air Bag Pressure	99		
Lubrication	91		
T			
Table of Contents	3		
Tandem Pumps	35		
Tank Switch	26		
Throttle Control	25		
Tilt Adjust Handle	23		
Tires			
Air Pressure	99		
Filling	99		
Mounting	99		
Specifications	20		
Toe-In	97-98		
Adjusting	98		
Checking	97		
Torque Values			
Leg Bearing	96		
Wheel Lug Nuts	95		
Transom Pivot Tubes	91		
Lubrication	91		
Transporting Sprayer	75-77		
Cradling the Booms	75		
Driving	76		