

**2021 DETASSELER TOOL BAR (DTB)  
OPERATOR'S MANUAL  
493884**





**HAGIE**  
**CONTENTS**

---

**1 – INTRODUCTION**

A Word From Hagie Manufacturing Company ..... 1-1  
About This Manual ..... 1-1  
Safety Messages Used In This Manual ..... 1-2  
Service and Assistance ..... 1-2  
Product Warranty ..... 1-3  
Identification ..... 1-3  
Specifications ..... 1-4

**2 – SAFETY AND PRECAUTIONS**

Intended Use ..... 2-1  
Safety Precautions ..... 2-1  
Operator Presence Switch (OPS) ..... 2-3  
Safety Decals ..... 2-4

**3 – OPERATING YOUR DTB**

Detasseling System Components ..... 3-1  
Fold Procedure - Detasseler Tool Bar ..... 3-6  
Detasseling System - Operation ..... 3-9  
Tasseltrol™ XL/LS System 12 ..... 3-11

**4 – MAINTENANCE AND STORAGE**

Service - Lubrication ..... 4-1  
Service Intervals ..... 4-3  
Storage ..... 4-4

**5 – MISCELLANEOUS**

Transporting ..... 5-1  
Quick-Tach System - Detasseler Tool Bar ..... 5-3  
Attachment Assembly ..... 5-10  
Troubleshooting ..... 5-17



## SECTION 1 – INTRODUCTION

---

### A WORD FROM HAGIE MANUFACTURING COMPANY

Congratulations on the purchase of your Detasseler Tool Bar (DTB) attachment! We recommend that you review this operator's manual and become familiar with operating procedures and safety precautions before attempting to operate your DTB.

As with any piece of equipment, certain operating procedures, service, and maintenance are required to keep your DTB in top running condition. We have attempted herein to cover all of the adjustments required to fit varying conditions. However, there may be times when special care must be considered.

*NOTE: The user is responsible for inspecting the attachment and having parts repaired or replaced when continued use of the product causes damage or excessive wear to other parts.*

Hagie Manufacturing Company reserves the right to make changes in the design and material of any subsequent DTB without obligation to existing attachments.

Thank you for choosing a Hagie DTB and we ensure you of our continued interest and support in its optimal performance for you. We are proud to have you as a customer!

### ABOUT THIS MANUAL

#### NOTICE

The purpose of this manual is to guide you in the proper operation of the DTB attachment, as well as provide you with pertinent safety precautions and maintenance information. This manual is intended to cover the DTB attachment only and any differences in the operation of the sprayer controls. Refer to your sprayer operator's manual and all other literature that is included with the machine for complete instructions on machine operation.

#### NOTICE

Any pictures or illustrations contained within this manual that depict situations with shields, guards, rails, or lids removed are for demonstration only. Keep all shields and safety devices in place at all times.

This manual will aid you in the proper operation and service of your DTB attachment. It is the responsibility of the user to read the operator's manual and comply with the correct and safe operating procedures, as well as maintain the product according to the service information provided in the *Maintenance and Storage Section* elsewhere in this manual.

Photographs and illustrations used in this manual are of general nature only. Some of the equipment described and/or shown may or may not be available on your attachment.

Information described in this manual was correct at the time of printing. Because of Hagie Manufacturing Company's continuous product improvement, certain information may not be included in this manual. To obtain the most current operator's manual for your attachment, please visit [www.hagie.com](http://www.hagie.com).

Keep this manual in a convenient place for easy reference. This manual is considered a permanent fixture of the product. In the event of resale, this manual must accompany the DTB.

If you do not understand any part of this manual or require additional information or service, contact your local John Deere dealer for assistance.

## **SAFETY MESSAGES USED IN THIS MANUAL**

The following safety messages found throughout this manual alert you of situations that could become potentially dangerous to the operator, service personnel, or equipment.

### **⚠ DANGER**

The signal word DANGER indicates a hazardous situation which, if not avoided, will result in death or serious injury.

### **⚠ WARNING**

The signal word WARNING indicates a hazardous situation which, if not avoided, could result in death or serious injury.

### **⚠ CAUTION**

The signal word CAUTION indicates a hazardous situation which, if not avoided, could result in minor or moderate injury. CAUTION may also be used to alert against unsafe practices associated with events which could lead to personal injury.

### **NOTICE**

The signal word NOTICE indicates operator awareness which, if not avoided, may result in personal or property damage.

*NOTE: A "Note" is intended to make special mention of, or remark on.*

## **SERVICE AND ASSISTANCE**



### **John Deere Is At Your Service**

Customer satisfaction is important to Hagie and John Deere. Our dealers strive to provide you with prompt, efficient parts and service:

- Maintenance and service parts to support your equipment.

## SECTION 1 – INTRODUCTION



- Trained service technicians and the necessary diagnostic and repair tools to service your equipment.

### Customer Satisfaction Problem Resolution Process

Your John Deere dealer is dedicated to supporting your equipment and resolving any problem you may experience.

1. When contacting your dealer, be prepared with the following information:
  - Machine model and product identification number.
  - Date of purchase.
  - Nature of problem.
2. Discuss problem with dealer service manager.
3. If unable to resolve, explain problem to dealership manager and request assistance.
4. If you have a persistent problem your dealership is unable to resolve, ask your dealer to contact John Deere for assistance, or contact the Ag Customer Assistance Center at 1-866-99DEERE (866-993-3373) or e-mail us at [www.deere.com/en\\_US/ag/contactus](http://www.deere.com/en_US/ag/contactus).

The DTB attachment has an identification plate mounted on the main tool bar that provides attachment model and serial number.



DTB Identification Plate  
-Typical View



DTB Identification Plate Location  
(Located on the main tool bar)  
-Typical View

## PRODUCT WARRANTY

Please contact your local John Deere dealer for further information.

## IDENTIFICATION

### NOTICE

Reference to right and left-hand used throughout this manual refers to the position when seated in the operator's seat facing forward.

## SPECIFICATIONS

*NOTE: Dimensions may vary, depending on tire size.*

*NOTE: Refer to “Specifications” provided in the machine operator’s manual for complete machine dimensions.*

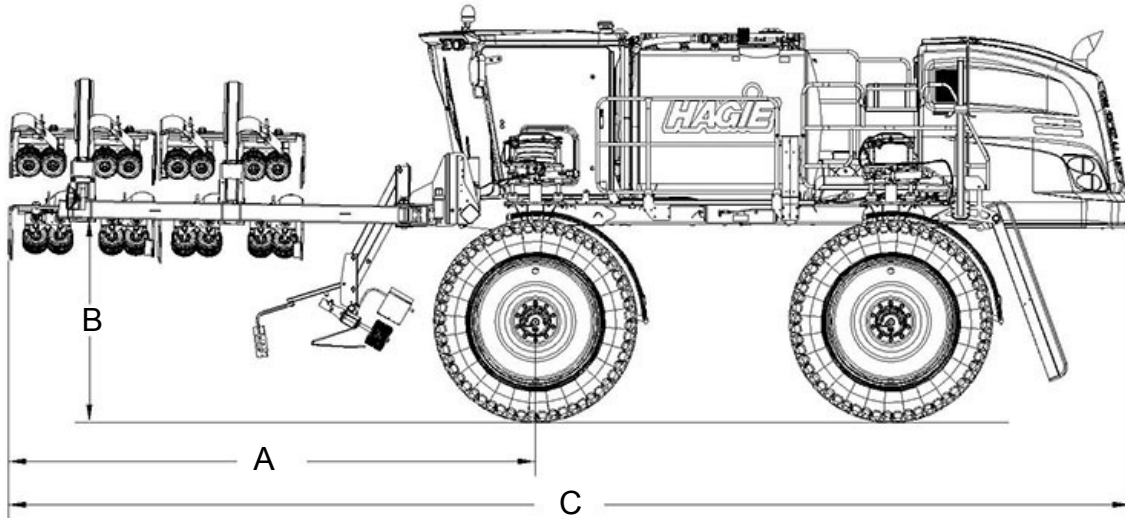

Detail	Description	Specification
A	Tool Bar Length (from front of tool bar to center of wheel hub)	<ul style="list-style-type: none"> <li>• 80.5”/204.5 cm (6 Row)</li> <li>• 128.5”/326.4 cm (8-10 Row)</li> <li>• 186.5”/473.7 cm (12-18 Row)</li> </ul>
B	Height (from bottom of tool bar to ground)	75.75”/192.4 cm *
C	Overall Machine Length (from front of tool bar to rear hood)	<ul style="list-style-type: none"> <li>• 315.5”/801.4 cm (6 Row, Short Frame)</li> <li>• 341.5”/867.4 cm (6 Row, Long Frame)</li> <li>• 363.5”/923.3 cm (8-10 Row, Short Frame)</li> <li>• 389.5”/989.3 cm (8-10 Row, Long Frame)</li> <li>• 421.5”/10 m (12-18 Row, Short Frame)</li> <li>• 447.5”/11 m (12-18 Row, Long Frame)</li> </ul>
D	Overall Width (boom cradles)	153”/388.6 cm

*\* Refer to “Tire Specifications” provided in the machine operator’s manual for a complete listing of tire options when configuring specifications on your model.*

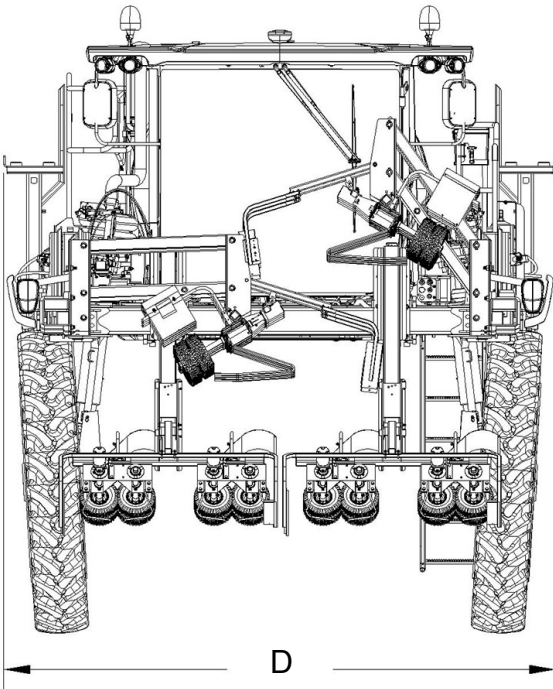

## General Information

### NOTICE

Because Hagie Manufacturing Company offers a variety of options, the illustrations in this manual may show a machine equipped other than standard. Machine dimension and weight values may vary, depending on available equipment.

- **Frame Type:** 4x8" (10.2x20.3 cm) modular platform frame
- **Suspension:** 4-wheel, individual, auto air-ride
- **Shipping Width:** 153"/388.6 cm (90/100' boom cradles)
- **Approximate Dry Weight:** 3,204 lbs./1,453 kg (8-10 row tool bar)



Description	Specification
<b>General</b>	
<b>Monitors/Controls</b>	Machine Display (Tasselrol™ XL)
<b>General System</b>	Light sensing system, depth command, electrical disconnect, hydraulic couplers
<b>Outriggers</b>	
<b>12-Row</b>	134"/340.4 cm (1 left, 1 right)
<b>8-Row</b>	75"/190.5 cm (1 left, 1 right)
<b>Quad Pullers</b>	
<b>Number of Rows Available</b>	6, 8, 10, or 12
<b>Drive</b>	Hydraulic
<b>Tire Size</b>	4.10/3.50 2-ply
<b>Tire Pressure</b>	10 PSI/.7 bar
<b>Operating Speed</b>	<ul style="list-style-type: none"> <li>• Min Speed = 375 RPM</li> <li>• Mid Speed = 400 RPM</li> <li>• Max Speed = 425 RPM</li> </ul> <p><i>NOTE: It is recommended to set the quad pullers as close to "mid" speed range as possible.</i></p>
<b>Pulling Height</b>	<ul style="list-style-type: none"> <li>• Minimum Range = 32-97" (81.3-246.4 cm)</li> <li>• Maximum Range = 40-105" (101.6-266.7 cm)</li> </ul>
<b>Weight (per assembly)</b>	86 lbs. (39 kg)
<b>Cutter Heads</b>	
<b>Number of Rows Available</b>	6, 8, 10, or 12
<b>Drive</b>	Hydraulic
<b>Blade Size</b>	18"/45.7 cm
<b>Operating Speed</b>	<ul style="list-style-type: none"> <li>• Min Speed = 2900 RPM</li> <li>• Mid Speed = 3000 RPM</li> <li>• Max Speed = 3100 RPM</li> </ul> <p><i>NOTE: It is recommended to set the cutter heads as close to "mid" speed range as possible.</i></p>
<b>Cutting Height</b>	<ul style="list-style-type: none"> <li>• Minimum Range = 29-94" (73.7-238.8 cm)</li> <li>• Maximum Range = 13-102" (33-259.1 cm)</li> </ul>
<b>Weight (per assembly)</b>	62 lbs. (28 kg)



## SECTION 2 – SAFETY AND PRECAUTIONS

---

### INTENDED USE

#### NOTICE

This attachment is designed for and intended to be used for the removal of tassels from the tops of corn plants. Use in any other way or for any other purpose is considered misuse of this attachment.

Most accidents occur as the result of failure to follow basic and fundamental safety rules and precautions. Recognizing potential safety hazards, following correct and safe operating procedures described in this manual, and complying with safety warnings located throughout the machine and attachment may reduce the risk of accidents.

There is no way to completely eliminate the potential for danger when operating agricultural equipment. Therefore, you must study this operator's manual and understand how to operate the attachment controls for safe operation before using the attachment. Likewise, never let anyone operate the attachment without proper instruction.

Do not operate the attachment for anything other than its intended use. Hagie Manufacturing Company shall not be liable for any damage, injury, or death associated with improper use of the attachment.

Do not make any modifications such as, but not limited to, weldments, add-ons, adaptations, or changes from the original design of the attachment. Such modifications may become safety hazards to you and others and **will void all warranties**.

Replace missing, faded, or damaged safety signs. Refer to "Safety Decals" elsewhere in this section for correct sign and placement.

### SAFETY PRECAUTIONS

#### General Safety

- Before operating the attachment, ensure there are no obstacles or persons in the path of travel.
- Keep clear of all moving parts and keep others away while operating.
- The hydraulic and electrical control systems are optimized for use with this attachment. Any modification to these systems may lead to unintended or uncontrolled motion. Do NOT install add-on control systems that are not approved by Hagie Manufacturing Company.
- Some conditions cannot be completely safeguarded against without interfering with efficient operation of the machine and/or reasonable accessibility. In these cases, decals have been installed to provide the operator with hazard information. Do NOT remove decals for any reason. If a decal is damaged or missing, contact your local John Deere dealer for replacement.



#### Wear Protective Clothing

- Do not wear loose fitting clothing that could get caught in moving parts. Wear safety equipment that is appropriate for the job.



- Do not store chemical-soaked clothing in the cab. Clean off as much mud and dirt from your shoes as you can before entering the cab.

### Protect Against Noise

- Wear suitable hearing protection. Prolonged exposure to loud noise may result in loss of hearing.



### Be Prepared

- Be prepared for an emergency. Keep a fire extinguisher, first aid kit, and clean water in the cab at all times.
- Service the fire extinguisher regularly.
- Keep an accurate inventory of supplies in the first aid kit and dispose of any items that have expired.

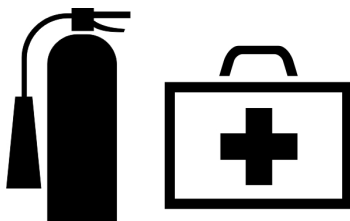

### General Maintenance Safety

- Turn off sprayer engine before checking, adjusting, repairing, lubricating, or cleaning any part of the attachment.

- Disconnect the battery ground cable and turn the Battery Disconnect Switch OFF before servicing the electrical system or welding on the attachment.



### Remove Accumulated Crop Debris

- The buildup of crop debris in the engine compartment, on the engine, or near moving parts is a fire hazard. Check and clean areas frequently. Before performing any inspection or service, engage the parking brake, shut off the engine, and remove the key.



### Remove Paint Before Welding or Heating

- Avoid toxic fumes and dust. Hazardous fumes can be generated when paint is heated by welding, soldering, or using a torch.



- Do not use chlorinated solvents in areas where welding will take place.
- Perform all work in an area that is well ventilated to carry toxic fumes and dust away.

## SECTION 2 – SAFETY AND PRECAUTIONS



- Dispose of paint and solvents properly.

### Avoid Heating Near Pressurized Lines

- Avoid torching, welding, and soldering near pressurized hydraulic lines. Pressurized lines may accidentally burst when heat goes beyond the immediate flame area.



### Safe Hydraulic Maintenance

- Always practice personal safety when performing service or maintenance on the hydraulic system.
- Use caution when working around hydraulic fluid under pressure. Escaping fluid can have sufficient force to penetrate your skin, causing serious injury. This fluid may also be hot enough to burn.

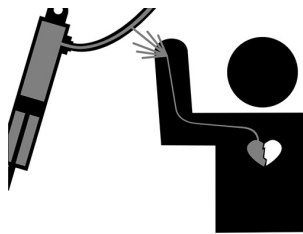

- Always lower the load or relieve pressure before repairing a hydraulic leak.

This safety feature introduces an electrical interlock that ensures that when the operator is out of the cab, the operation of these functions have stopped. This is achieved by using the OPS to prevent the cutter heads and quad pullers from operating if the operator is not seated in the operator's seat for two (2) seconds.

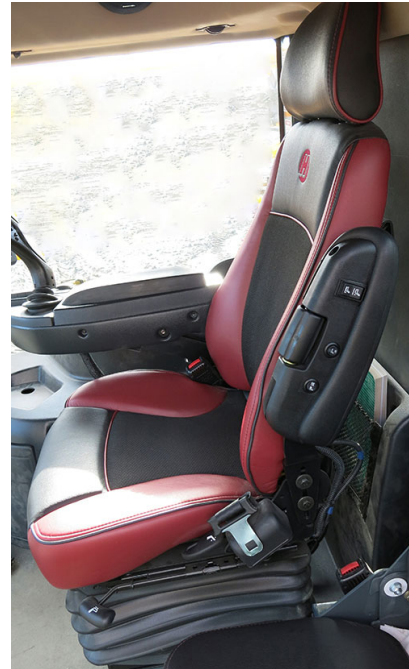

Operator Presence Switch  
(Located inside the operator's seat)  
-Typical View

When the operator leaves the operator's seat while the machine is running, a warning message will appear on the Machine Display to alert the operator to operate the machine from seat.

---

## OPERATOR PRESENCE SWITCH (OPS)

The Operator Presence Switch (located inside the operator's seat) protects the operator from exposure to moving parts or hazards when operating the detasseler cutter heads and quad pullers.

**Decal Locations**

**650178**  
**(2) Quick-Tach**

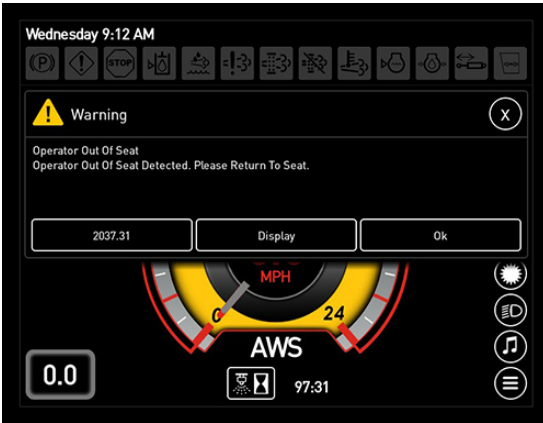

Operator Out Of Seat Message  
(Located on the Machine Display)

**To Resume Operation**

- Return to operator's seat.
- Press OK on the Machine Display warning message.
- Depress the Main Motor Switch (located on the Hydrostatic Drive Control Handle) to resume operation.

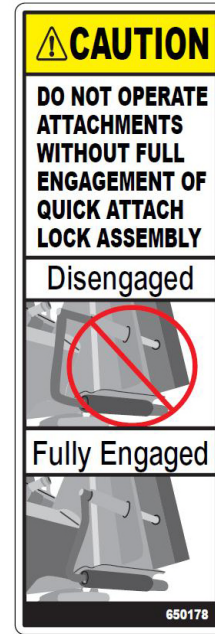

**SAFETY DECALS**

Decals warning you of avoidable danger are located on various parts of the attachment and cab area. They are there for your personal safety and protection. DO NOT remove them. They will fracture upon attempted removal and therefore, must be replaced.

Following are locations of important safety decals. Replace them if they are damaged or missing. All safety decals, instructional decals, or machine striping may be purchased through your local John Deere dealer.

To replace safety decals, ensure the installation area is clean and dry and decide on exact position before you remove the backing paper.

**650218**  
**(2) - One located on each end of combo attachment**

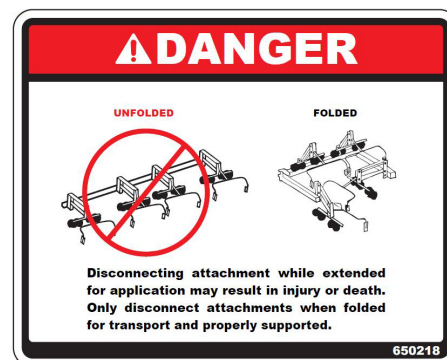

## SECTION 2 – SAFETY AND PRECAUTIONS



**650258**  
(Located on each side of cutter head assemblies)



### CAUTION

SEVERING OF FINGERS OR HAND.  
DO NOT PLACE FINGERS OR  
HAND NEAR A MOVING CUTTER BLADE,  
ATTEMPT TO STOP A MOVING CUTTER  
BLADE, OR PERFORM MAINTENANCE  
NEAR A MOVING CUTTER BLADE.

**650259**  
(Located on mounting tube of each  
quad puller head assembly)



### CAUTION

RISK OF INJURY FROM ROTATING TIRES.  
DO NOT PLACE FINGERS OR HAND  
MOVING QUAD PULLER TIRES, DISLodge A  
WEDGED OBJECT FROM MOVING TIRES, OR  
PERFORM MAINTENANCE NEAR MOVING TIRES.

**650303**  
(Located on right-hand cab window)

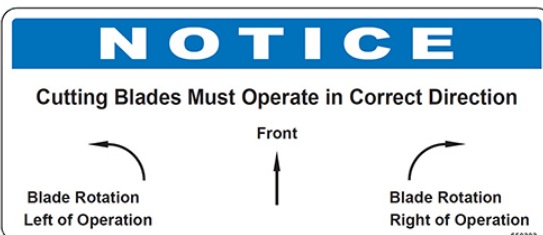

**HXE28534**  
(Located on left-hand front cross  
member)

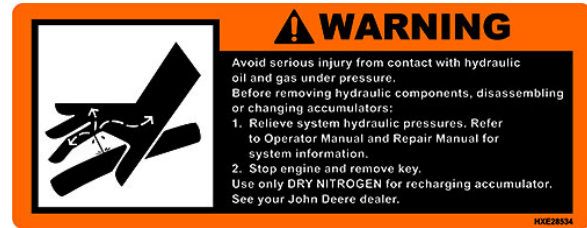

**650379**  
(Located on right-hand cab window)

### \* TO ENGAGE DETASSELING HEAD HYD MTRS:

1. Reduce engine speed to an idle.
2. Clear area of unauthorized personnel.
3. Turn individual motor control switches to "ON".
4. Slowly increase engine RPM to desired speed.

650379



## SECTION 3 – OPERATING YOUR DTB

### DETASSELING SYSTEM COMPONENTS

The Detasseling System is a constantly monitored and continuously adjusted system. The cab-mounted Machine Display monitor receives data from the photo light sensors to determine cutting/pulling height.

The following information in this section explains the detasseling components and their operation. Read the following section entirely before operating the Detasseling System.

#### NOTICE

Attachment maintenance and repair, including clearing blockages/unplugging detasseler components should be performed by qualified service personnel only.

- (A) - Detasseler Tool Bar Attachment
- (B) - LS System 12/Depth Command
- (C) - LS Photo Light Sensors
- (D) - Cutter Heads
- (E) - Quad Pullers
- (F) - Machine Display
- (G) - All Up/Down Switch\*
- (H) - Outrigger Fold Switches (Left/Right)
- (I) - Main Motor Switch

\* The Lift Icon Buttons on the Machine Display “DTB Lifts/Motors” screen may also be used to raise/lower all lifts simultaneously.

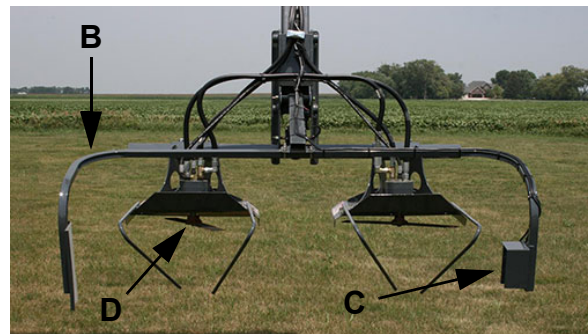

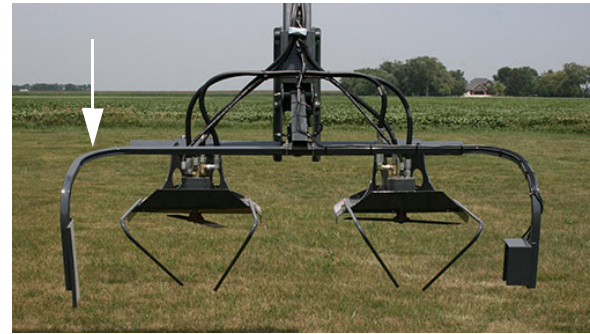
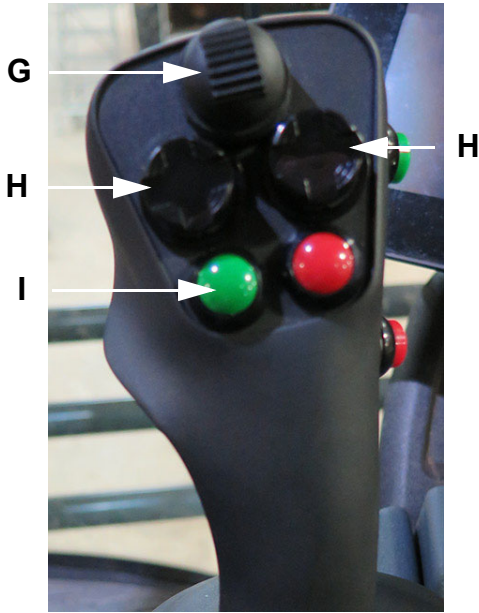

LS System 12/Depth Command  
-Typical View

### LS Photo Light Sensors

The LS Photo Light Sensors detect crop height and send a signal to the LS System 12/Depth Command, which controls automatic height adjustment.

### Detasseler Tool Bar Attachment (DTB)

The DTB attachment paired with the STS provides a high-clearance design along with adjustable automatic height control to perform timely detasseling of corn crops when timing is critical. The DTB unites functionality with customizable options to provide a solution that suits the individual needs of your operation.



DTB Attachment  
(Shown with quad pullers)  
-Typical View



LS Photo Light Sensor Assembly  
-Typical View

### LS System 12/Depth Command

The LS (Light Sensing) System 12/Depth Command is an automatic height adjustment system controlled by the Machine Display inside the cab.



**Cutter Heads**

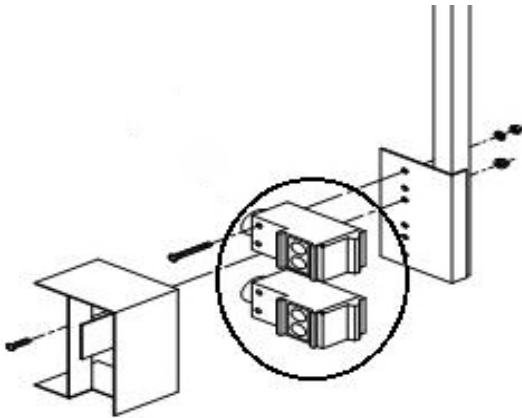

LS Photo Lights (Upper/Lower)  
-Typical View

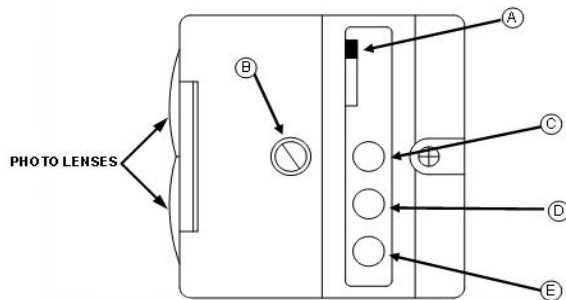

-Typical View

- The upper and lower LS Photo Lights are equipped with LED lights (A, C, D, E) that indicate operation status.
- The LT/DK (Light/Dark) Switch (A) (located on the photo light sensor) changes the activated condition of the green LED from ON (LT) to OFF (DK).
- The Sensitivity Adjustment Screw (B) should always be set to MAXIMUM.
- The Yellow LED Light (C) indicates the power is ON.
- The Green LED Light (D) indicates output energized (sending a signal to the Tasselrol™ XL system).
- The Red LED Light (E) indicates that the photo light is receiving reflected signal.



**CAUTION**

SEVERING OF FINGERS OR HAND.  
DO NOT PLACE FINGERS OR  
HAND NEAR A MOVING CUTTER BLADE,  
ATTEMPT TO STOP A MOVING CUTTER  
BLADE, OR PERFORM MAINTENANCE  
NEAR A MOVING CUTTER BLADE.

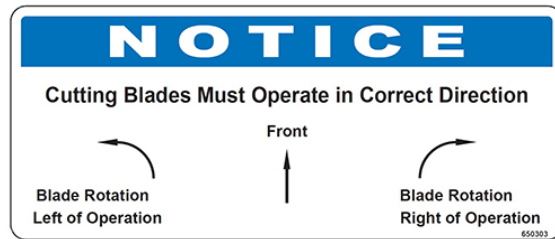

The hydraulically-driven Cutter Heads go through rows of corn and cut the tassels from the top of corn plants.

Cutter Head Speeds		
Min Speed	=	2900 RPM
Mid Speed	=	3000 RPM
Max Speed	=	3100 RPM

*NOTE: It is recommended to set the cutter heads as close to "mid" speed range as possible.*

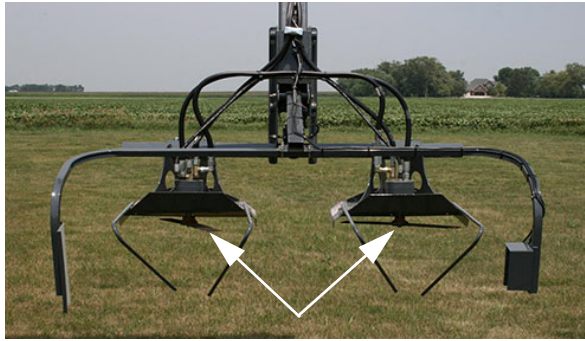

Cutter Heads  
-Typical View

Quad Puller Speeds		
Min Speed	=	375 RPM
Mid Speed	=	400 RPM
Max Speed	=	425 RPM

*NOTE: It is recommended to set the quad pullers as close to “mid” speed range as possible.*

## Quad Pullers



### CAUTION

RISK OF INJURY FROM ROTATING TIRES. DO NOT PLACE FINGERS OR HAND NEAR MOVING QUAD PULLER TIRES, DISLodge A WEDGED OBJECT FROM MOVING TIRES, OR PERFORM MAINTENANCE NEAR MOVING TIRES.

### NOTICE

Ensure quad puller tires have equal pressure. Check tire pressure daily.

*NOTE: Maximum tire pressure = 10 psi (.7 bar).*

The hydraulically-driven Quad Pullers go through rows of corn and pull the tassels from the top of corn plants by catching it between the Quad Puller tires moving at high speed in opposite directions.



Quad Pullers  
-Typical View

## Machine Display

The Machine Display is the central control center of the machine. In addition, it is used for programming detasseling heads to control tool bar functions, such as:

- Lift/Motor Control (Auto/Manual Mode)
- Depth Command
- Light Sensing
- Calibration



Machine Display  
-Typical View



Lift Icon Buttons (All Up/Down)  
(Located on the Machine Display  
DTB Lifts/Motors Screen)  
-Typical View

### All Up/Down Switch

The All Up/Down Switch (located on the Hydrostatic Drive Control Handle) is used to raise or lower all lifts simultaneously. In addition, the same all up/down function can be controlled by pressing the Lift Icon Buttons - UP/DOWN (located on the Machine Display “DTB Lifts/Motors” screen).

### Outrigger Fold Switches

#### (Left/Right)

The hydraulic Outrigger Fold Switches (located on the Hydrostatic Drive Control Handle) are used to hydraulically fold/unfold the outriggers.



All Up/Down Switch  
(Located on the Hydrostatic  
Drive Control Handle)  
-Typical View



Outrigger Fold Switches - Left/Right  
(Located on the Hydrostatic  
Drive Control Handle)  
-Typical View

## Main Motor Switch

*NOTE: The Main Motor Switch is used for detasseling functions. This switch is referred to as the Master Spray Switch when used for spray application. Refer to your machine operator's manual for further information.*

The detasseling head motors are controlled by the Main Motor Switch (located on the Hydrostatic Drive Control Handle). This switch must be in the ON position to enable detasseling head operation.



Main Motor Switch  
(Located on the Hydrostatic  
Drive Control Handle)  
-Typical View

## FOLD PROCEDURE - DETASSELER TOOL BAR

### **WARNING**

Before proceeding, check area around the machine for bystanders, overhead objects, and power lines. Failure to comply may result in serious injury or death.

## Unfolding the Attachment

(From storage position)

1. Ensure the Hydrostatic Drive Control Handle is in the NEUTRAL position.

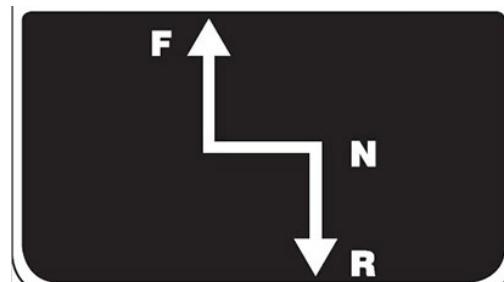

Hydrostatic Drive Control Handle  
-Typical View

2. Engage the parking brake.

3. Start the engine.
4. Press the Field/Road Button (located on the Machine Display “DTB Lifts/Motors” screen) and change the machine’s drive state to FIELD.

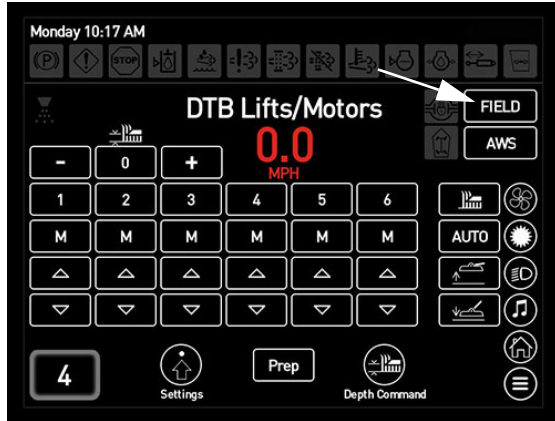

Field/Road Button  
(Located on the Machine Display  
DTB Lifts/Motors Screen)

5. Press and hold the corresponding Outrigger Fold Switch (located on the Hydrostatic Drive Control Handle) in the OUT (Unfold) position until outriggers fully extend.

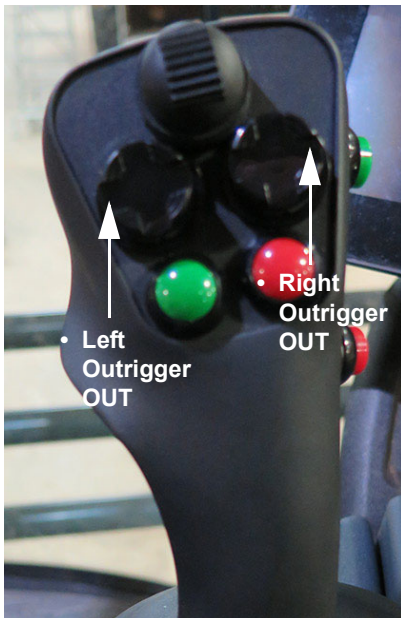

Outrigger Fold Switches - Left/Right  
(Located on the Hydrostatic  
Drive Control Handle)  
-Typical View

6. If equipped with the 4-2 Detasseler Tool Bar, continue to press and hold the Outrigger Fold Switches to extend the left and right-hand slide extensions.



4-2 Detasseler Tool Bar - *if equipped*  
(Extended View)

### Folding the Attachment (To storage position)

#### NOTICE

**4-2 Detasseler Tool Bar Only**

Ensure the outer slide extensions are fully retracted before folding the outriggers in. Failure to comply will result in property damage.

#### NOTICE

Stagger detasseling heads before folding the outriggers. Failure to comply will result in property damage. Refer to “Transporting” in the *Miscellaneous Section* elsewhere in this manual for further information.

1. Press the Attachment Button (located on the Machine Display Main Menu).

## SECTION 3 – OPERATING YOUR DTB



Attachment Button  
(Located on the Machine  
Display Main Menu)

2. PREP TO FOLD - Press the Prep Button (located on the Machine Display “DTB Lifts/Motors” screen OR the “DTB Depth Command” screen).

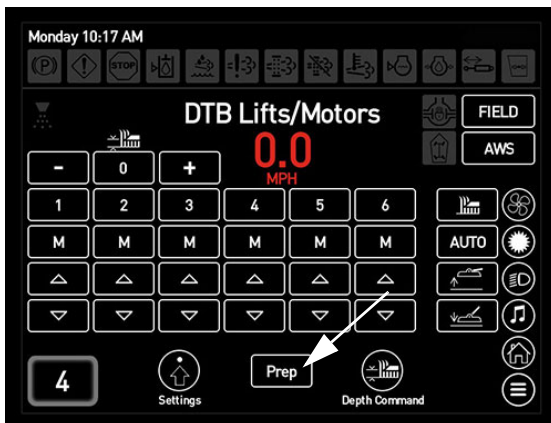

Prep Button  
(Located on the Machine Display  
DTB Lifts/Motors Screen or  
DTB Depth Command Screen)

3. Press BOTH left and right-hand Level Switches (located on the Hydrostatic Drive Control Handle) either UP or DOWN simultaneously.  
The tool bar will then adjust the lifts and the depth command actuators will position to allow folding.

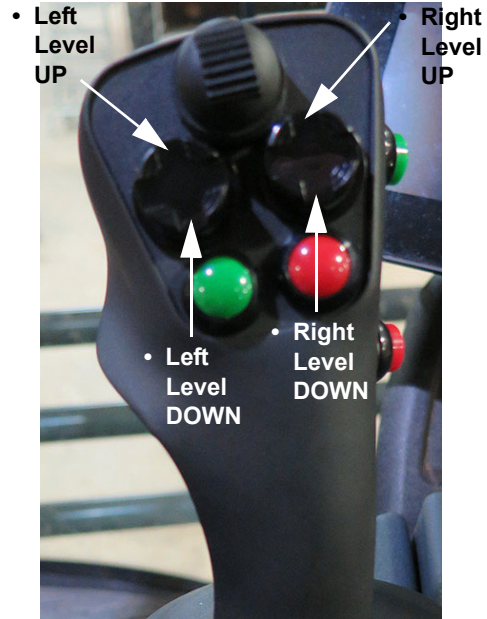

Level Switches - Left/Right  
(Located on the Hydrostatic  
Drive Control Handle)  
-Typical View

*NOTE: Once the tool bar is prepped to fold, a “DTB Prep to Fold Complete” message will appear on the display.*

4. Press and hold the corresponding Out-rigger Fold Switch (located on the Hydrostatic Drive Control Handle) in the IN (Fold) position until outriggers fully retract.

*NOTE: If equipped with the 4-2 Detasseler Tool Bar, the left and right-hand slide extensions will retract first, followed by the outriggers when the Outrigger Fold Switches are depressed.*

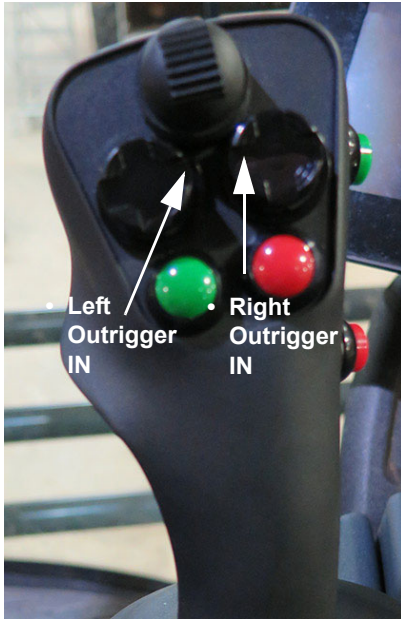

Outrigger Fold Switches - Left/Right  
(Located on the Hydrostatic  
Drive Control Handle)  
-Typical View

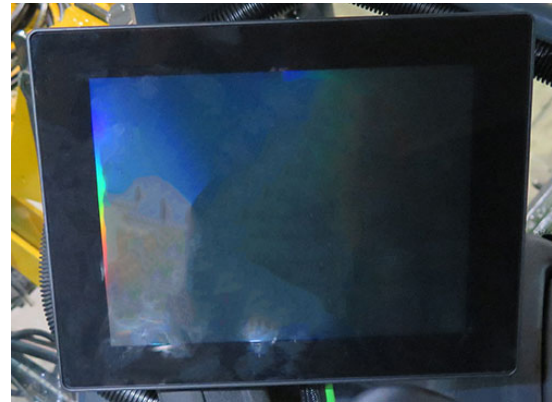

Machine Display  
-Typical View

2. Ensure the Hydrostatic Drive Control Handle is in the NEUTRAL position.



---

## DETASSELING SYSTEM - OPERATION

### Getting Started

1. Program the Tasselrol™ XL system through the Machine Display.  
***Refer to “Tasselrol XL/LS System 12” provided elsewhere in this section for further information.***

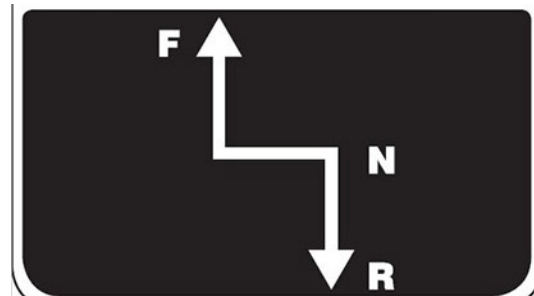

Hydrostatic Drive Control Handle  
-Typical View

3. Engage the parking brake.
4. Start the engine.

## SECTION 3 – OPERATING YOUR DTB



5. Press the Field/Road Button (located on the Machine Display “DTB Lifts/Motors” screen) and change the machine’s drive state to FIELD.

*NOTE: The drive state of the machine cannot be changed unless the Hydrostatic Drive Control Handle is in the NEUTRAL position (and machine speed is less than 0.5 mph/ 0.8 km/h).*

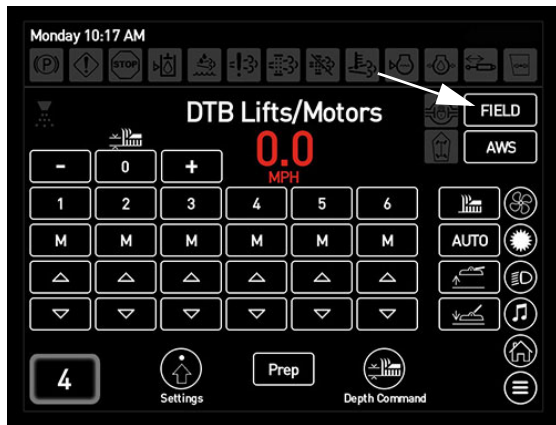

Field/Road Button  
(Located on the Machine Display  
DTB Lifts/Motors Screen)

6. Unfold and position tool bar to desired position. Refer to “Fold Procedure - Detasseler Tool Bar” elsewhere in this section for further information.
7. Press the corresponding Motor Button(s) (located on the Machine Display “DTB Lifts/Motors” screen) to turn desired detasseling head motors ON.

*NOTE: Press the Motor Icon Button (next to the individual motor buttons) to activate all motors.*

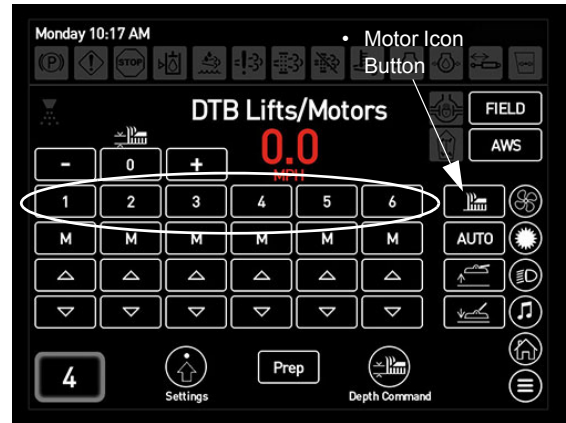

Motor Buttons (1-6)  
(Located on the Machine Display  
DTB Lifts/Motors Screen)

8. Turn the Main Motor Switch (located on the Hydrostatic Drive Control Handle) ON.

### NOTICE

If loss of hydraulic pressure occurs or the low hydraulic oil warning indicator appears on the Machine Display, shut down the system immediately. Failure to comply may result in system damage and will void the warranty.





Main Motor Switch  
(Located on the Hydrostatic  
Drive Control Handle)  
-Typical View

9. Press and hold the Throttle Switch (located near the Hydrostatic Drive Control Handle) in the UP/“rabbit icon” position to achieve the recommended RPM to operate the detasseling head motors.

*NOTE: Detasseling heads will be available for immediate use by increasing engine RPM.*

## NOTICE

Operating the Detasseling System below the recommended engine RPM (STS10/STS12 - 2400 RPM, STS14/STS16 - 2200 RPM) will not provide the system with adequate hydraulic oil flow and may cause degraded or poor performance.



Throttle Switch  
(Located near the Hydrostatic  
Drive Control Handle)  
-Typical View

10. Slowly move the Hydrostatic Drive Control Handle forward to obtain desired ground speed.

## TASSELTROL™ XL/LS SYSTEM 12

(Light Sensing/Depth Control)

### Lifts/Motors

#### Manual/Auto Mode

In **MANUAL MODE**, the lifts move manually, or not using the photoeyes to adjust the lift height. In **AUTO MODE**, the lifts will automatically raise if both photoeyes are covered, and lower if the bottom photoeye is not covered.

## SECTION 3 – OPERATING YOUR DTB



- Press the Attachment Button on the Main Menu to navigate to the “DTB Lifts/Motors” screen.



Attachment Button

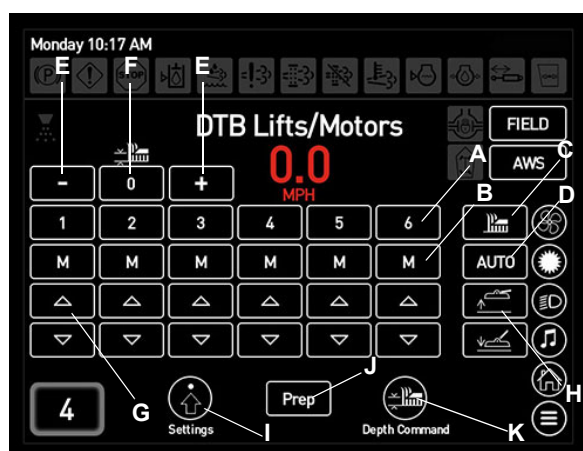

DTB Lifts/Motors Screen  
(Manual Mode)

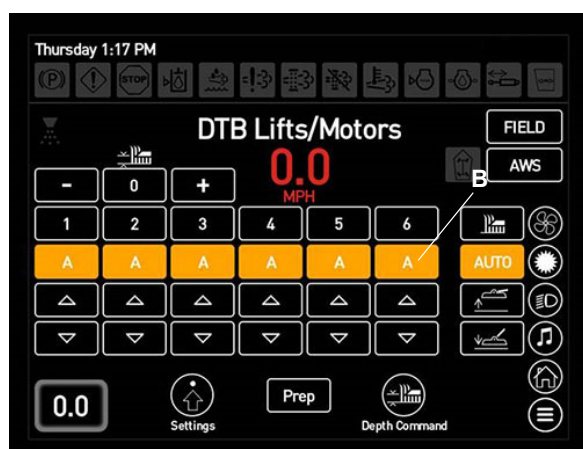

DTB Lifts/Motors Screen  
(Auto Mode)

- Press Motor Buttons (1-6) **(A)** to turn desired motor(s) on/off.
- Press the M or A Button(s) **(B)** below the corresponding lift number to enable Manual or Auto mode.
- Press the Motor Icon Button **(C)** to activate all motors.
- Press the Auto Button **(D)** to enable Manual or Auto mode for all lifts.

*NOTE: This button will always say “AUTO”, but will illuminate when all lifts are in Auto mode.*

- Press the “-” or “+” Buttons **(E)** to increase/decrease depth command height for all lifts.

*NOTE: Press center of button **(F)** to set all depth command actuators to desired height.*

- Press and Hold the desired Up or Down Arrow Button **(G)** below the corresponding lift number to raise/lower the individual lifts.
- Press and Hold desired Lift Icon Button **(H)** (UP or DOWN) to raise/lower all lifts together.

*NOTE: Same function can be done through the All Up/Down Switch (located on the hydrostatic drive control handle).*

- Press the Settings Button **(I)** to navigate to the “DTB Settings” screen.
- Prep (Prep to Fold) - Press the Prep Button **(J)**, then press BOTH left and right-hand level switches (located on the hydrostatic drive control handle) either up or down simultaneously. The tool bar will then adjust the lifts and the depth command actuators will position to allow the main folds to be folded.

*NOTE: If equipped with the 4-2 Detasseler Tool Bar, there will be a 10 second delay to allow the tool bar to retract.*

*NOTE: Once the tool bar is prepped to fold, a “DTB Prep to Fold Complete” message will appear on the display. Complete the folding procedure by pressing the corresponding left and right-hand Outrigger Fold Switches (located on the hydrostatic drive control handle).*

- Press the Depth Command Button (**K**) to navigate to the “DTB Depth Command” screen.

### Depth Command

- Press the “-” or “+” Buttons (**A**) to increase/decrease depth command height for all lifts.

*NOTE: Press center of button (B) to set all depth command actuators to desired height.*

- 1-6 row (**C**) (lift number).
- 0 row (**D**) (actual position of each depth command actuator).
- Press the desired Up/Down Arrow Button(s) (**E**) to raise/lower the corresponding depth command actuators.
- MEM (Memorize) (**F**) - Press the MEM Button to allow the system to remember the position of all photoeyes.
- MR (Memory Recall) (**G**) - Press the MR Button to allow the photoeyes to go back to the previously memorized position.
- Press the Settings Button (**H**) to navigate to the “DTB Settings” screen.
- Prep (Prep to Fold) - Press the Prep Button (**I**), then press BOTH left and right-hand level switches (located on the hydrostatic drive control handle) either up or down simultaneously. The tool bar will then adjust the lifts and the depth command actuators will position to allow the main folds to be folded.

*NOTE: If equipped with the 4-2 Detasseler Tool Bar, there will be a 10 second delay to allow the tool bar to retract.*

*NOTE: Once the tool bar is prepped to fold, a “DTB Prep to Fold Complete” message will appear on the display. Complete the folding procedure by pressing the corresponding left and right-hand Outrigger Fold Switches (located on the hydrostatic drive control handle).*

- Press the Lift/Motors Button (**J**) to navigate to the “DTB Lifts/Motors” screen.

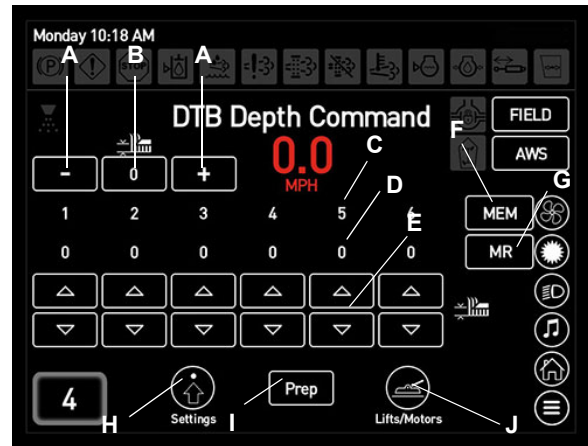

DTB Depth Command Screen

### Settings

- **Lift Up Speed** - Press the Auto, Manual, or All Up Button to navigate directly to the corresponding “DTB Lift Up” screen to adjust lift speed for desired mode.
- **All Up Time** - Amount of time that the lifts will raise in the “All Up” state. Swipe left or right to decrease/increase the amount of time (in 5 second intervals) that the lifts will travel up after the All Up Switch (located on the hydrostatic drive control handle) is pressed momentarily.

*NOTE: With a value of 0 seconds, the lifts will stop raising when the All Up Switch is released.*

- **Response Parameter** - Time delay between a change in the photoeye status until the lift responds. A higher number means that the lift will wait longer between a change in photoeye status until that lift responds to the change.  
*Example: Time delay between bottom photoeye being uncovered until that lift moves down. Also, time delay between the top photoeye being covered until that lift moves up.*
- **Bottom Parameter** - Quickness of response for lift to move down when the bottom photoeye is uncovered. A higher number means that the output will reach the maximum auto speed for that lift faster.

## SECTION 3 – OPERATING YOUR DTB



- **Top Parameter** - Quickness of response for lift to move up when the top photoeye is covered. A higher number means that the output will reach the maximum auto speed for that lift faster.
- **Auto One Tap** - When this parameter is enabled (swipe right to activate, or left to deactivate) and the lift is in Auto mode, that lift will lift up when the Lift Up Button is pressed for that lift for the “All Up Time”. To set the lift back to Auto mode, press the All Up/Down Switch (located on the hydrostatic drive control handle) in the DOWN position, or the Auto Button on the “DTB Lifts/Motors” screen.
- **CAL** - Press the Cal Button to navigate to the “Calibration” screen.

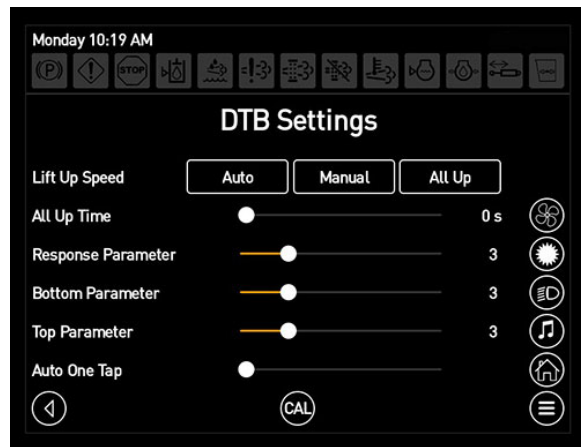

DTB Settings Screen

### Lift Up (Auto)

- Each lift speed can be adjusted in Auto mode. Swipe right to increase speed, or left to decrease speed.

### Lift Up (Manual)

Each lift speed can be adjusted in Manual mode. Swipe right to increase speed, or left to decrease speed.

### Lift Up (All Up)

- Set All-Up speed for entire tool bar by adjusting the “All-Up Speed” (last parameter). Swipe right to increase speed, or left to decrease speed.

*NOTE: Each lift can be offset from this overall speed in order to match speeds of the other lifts.*

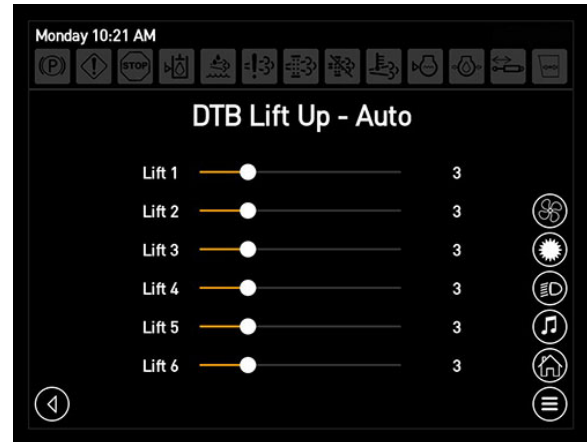

DTB Lift Up (Auto) Screen

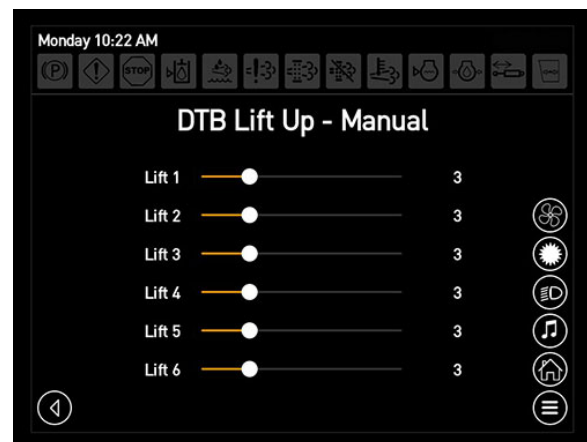

DTB Lift Up (Manual) Screen

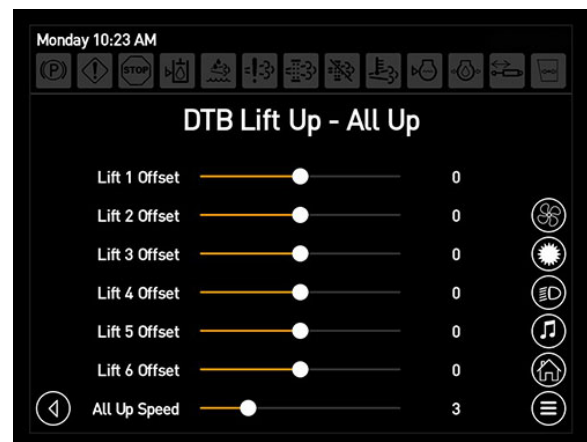

DTB Lift Up (All Up) Screen

## Calibration

- Sensor Calibration - Press Depth Command UP Button (**A**) to achieve lowest

position sensor reading, then press “Set Min”.

- Press Depth Command DOWN Button **(B)** to achieve highest position sensor reading, then press “Set Max”.
- For lifts, move lifts to lowest position, then press “Set Min”. Move lifts to highest position, then press “Set Max”. Press and Hold desired Lift Icon Button **(C)** UP or DOWN to raise/lower all lifts together.

*NOTE: Sensor calibration only needs to be performed if a position sensor is replaced or the position sensor is not reading correctly.*

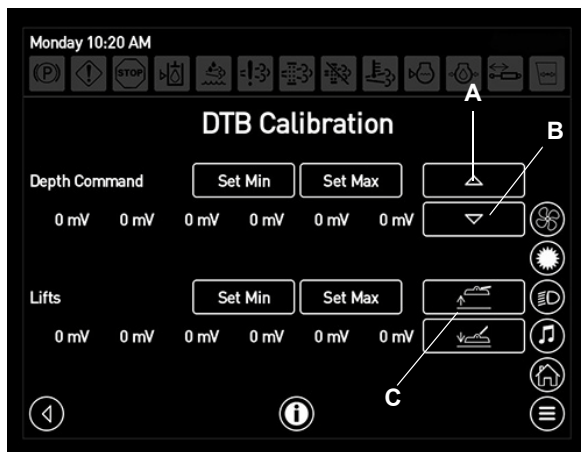

DTB Calibration Screen



## SECTION 4 – MAINTENANCE AND STORAGE

### SERVICE - LUBRICATION

#### NOTICE

Failure to properly lubricate pivot and friction points may result in unnecessary wear and damage.

#### Quad Puller Heads

- Lubricate each Quad Puller Head grease zerk (4 - two each side) twice per day (morning and noon suggested).



Quad Puller Head  
-Typical View

#### Outrigger Fold (Left and Right)

- Lubricate each left and right Outrigger Fold grease zerk (2) a minimum of every 50 hours of operation, or as needed.

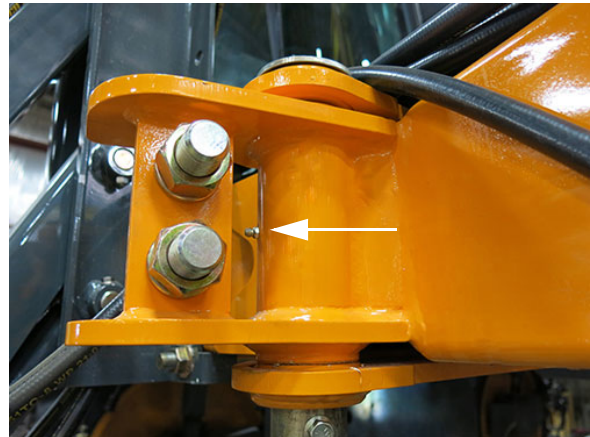

Outrigger Fold  
-Typical View

#### Lift Arm Assemblies

- Lubricate each Lift Arm Assembly grease zerk (6) a minimum of every 50 hours of operation, or as needed.

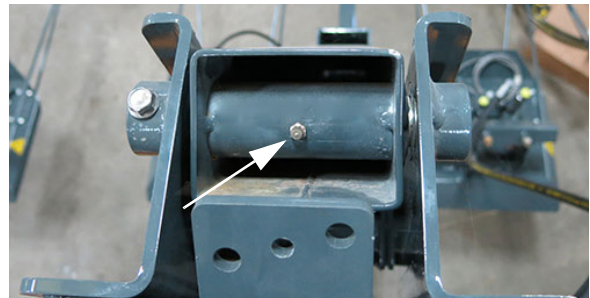

Lift Arm Assembly - Top  
-Typical View



Lift Arm Assembly - Mid  
-Typical View

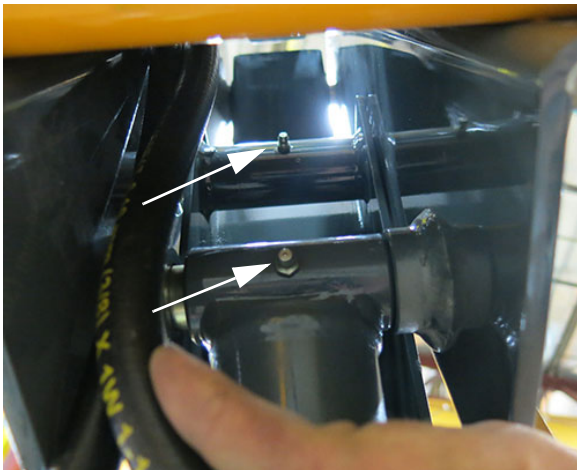

Lift Arm Assembly - Inner Arm  
-Typical View

*NOTE: An additional grease zerk is located  
inside of the lower lift arm frame.*

---

## SERVICE INTERVALS

Service Point	Daily/Before Each Use	50 Hrs.
Check Quad Puller Tire Pressure	X	
Check/Tighten Cutter Blade Retaining Bolts	X	
Lubricate Quad Puller Head Grease Zerks	X	
Lubricate Outrigger Fold Grease Zerks		X
Lubricate Lift Arm Assembly Grease Zerks		X



---

## STORAGE

### Preparing For Storage

1. Perform daily and weekly lubrication and maintenance inspections as required.
2. With the engine at normal operating temperature, cycle all the hydraulic functions.
3. Thoroughly wash the attachment and touch up any chipped or damaged paint.
4. Replace any damaged or missing decals.

*NOTE: Contact your local John Deere dealer for paint touch-up recommendations and decal replacement.*

5. Apply multi-purpose grease to hydraulic cylinder rods.
6. If the attachment will be stored separately, ensure that all electrical and hydraulic ends are capped or covered with a suitable covering.

### Removal From Storage

#### **NOTICE**

Protective compounds such as grease can harden under exposure to weather conditions. Be sure to remove any dried grease and reapply new, if necessary.

1. Remove any dried grease from the cylinder rods and re-apply if necessary.
2. Thoroughly clean the attachment.
3. Carefully unseal any openings that were sealed for storage.
4. Attach DTB to the sprayer and manually cycle the hydraulics two or three times to adequately lubricate components.



## SECTION 5 – MISCELLANEOUS

### TRANSPORTING

#### Transporting Your Machine with an Attachment

#### **WARNING**

When transporting the machine, observe the following to avoid serious injury or death:

- Check for adequate clearance before driving under any overhead obstructions.
- Contact with power lines may result in serious injury or death.

#### **CAUTION**

Ensure there is adequate clearance when transporting the sprayer near an object with clearance less than the transporting height and width of the overall machine and attachment.

#### **CAUTION**

Avoid collisions. Before transporting machine on a public roadway, check and follow local regulations regarding size limits, the use of lights, flags, signs, pilot vehicles, and other requirements for transporting loads using trailer.

### Folding the Outriggers

#### **NOTICE**

Stagger detasseling heads before folding the outriggers. Failure to comply will result in property damage.

Before folding the outriggers, the detasseling heads must be staggered in height. Damage will occur if detasseling heads are all the same height when the outriggers are folded.

#### To Stagger the Detasseling Heads

1. Press the Attachment Button (located on the Machine Display Main Menu).



Attachment Button  
(Located on the Machine Display Main Menu)

2. PREP TO FOLD - Press the Prep Button (located on the Machine Display “DTB Lifts/Motors” screen OR the “DTB Depth Command” screen).

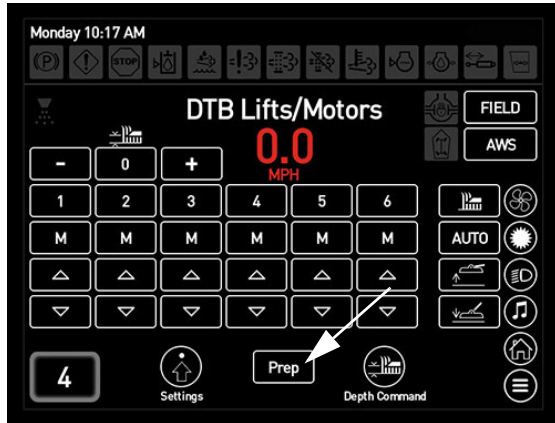

**Prep Button**  
(Located on the Machine Display  
DTB Lifts/Motors Screen or  
DTB Depth Command Screen)

3. Press BOTH left and right-hand Level Switches (located on the Hydrostatic Drive Control Handle) either UP or DOWN simultaneously.  
The tool bar will then adjust the lifts and the depth command actuators will position to allow folding.

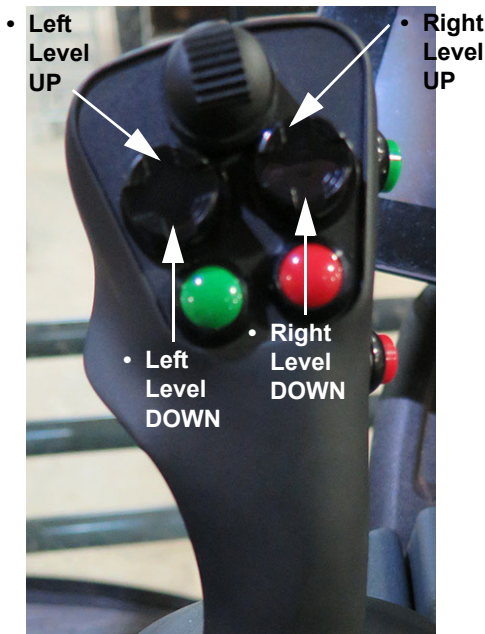

**Level Switches - Left/Right**  
(Located on the Hydrostatic  
Drive Control Handle)  
-Typical View

*NOTE: Once the tool bar is prepped to fold, a “DTB Prep to Fold Complete” message will appear on the display.*



**Staggered Detasseling Heads**  
-Typical View

Alternatively, if manual detasseling head staggering is desired, perform Steps 4-6 through the Machine Display. Refer to “Tasseltrol™ XL/LS System 12” provided elsewhere in this manual for further information.

4. Lower the two center detasseling heads all the way DOWN.
5. Raise all the detasseling heads on one side to approximately half of the fully raised height.
6. Raise the detasseling heads on the opposite side to the fully raised height.

**To Fold the Outriggers**

- Slowly fold the outriggers in, making adjustments (as necessary) to the height of the detasseling heads.  
Refer to “Fold Procedure - Detasseler Tool Bar” elsewhere in this manual for further information.

**NOTICE**

Do not attempt to make any adjustments to the detasseling heads after the outriggers are folded. Failure to comply may cause the stalk guides or depth command sensor bars to entangle, resulting in equipment damage.

## Transporting Machine Using Trailer

### Loading

**⚠ WARNING**

Keep all persons away from trailer when loading or unloading the sprayer. Failure to comply may result in serious injury or death.

**NOTICE**

Read and understand the trailer manufacturer's operation manual. Hitch the trailer to the pulling vehicle according to their recommendations.

**NOTICE**

The loaded height and width of the trailer must conform to state law in which it is being used. Do not exceed the trailer manufacturer's recommendations on loaded weight.

1. Pull the trailer to flat ground.
2. Apply the pulling vehicle's parking brake and turn the engine OFF.
3. Use tire chocks to keep the trailer from moving.
4. Ensure the DTB outriggers are in the fully retracted (folded) position.
5. Lower the trailer ramps and set ramp spacing for the machine's tread width setting.
6. Have an attendant help guide you onto the trailer.
7. Allow enough room between the machine and the pulling vehicle for safe turning.

8. Secure the machine onto the trailer using the recommended securement restraints (see trailer manufacturer's operation manual).
9. Cover or remove the SMV (Slow Moving Vehicle) emblem when traveling over 25 mph (40 km/h).

### Unloading

1. Pull the trailer to flat ground.
2. Apply the pulling vehicle's parking brake and turn the engine OFF.
3. Use tire chocks to keep the trailer from moving.
4. Lower the trailer ramps and set ramp spacing for the machine's tread width setting.
5. Carefully release the securement restraints.
6. Have an attendant help guide you off of the trailer.
7. Uncover or replace the SMV (Slow Moving Vehicle) emblem.

---

## QUICK-TACH SYSTEM - DETASSELER TOOL BAR

**⚠ WARNING**

When connecting or disconnecting the attachment, observe the following safety precautions:

- Monitor both sides of the attachment during fold procedure.
- Select a safe area that is solid and level before unfolding/folding the attachment.
- Clear area of personnel.
- Check for overhead obstructions.
- Do not unfold or fold combo attachment near power lines. Contact with power lines can result in serious injury or death.

**⚠ WARNING**

Turn the engine OFF before connecting/ disconnecting any hoses or electrical lines. Failure to comply may result in serious injury or death.

### Connecting the Detasseler Tool Bar Attachment

1. Square up to the DTB attachment.
2. Lower the machine by rotating the corresponding Air Suspension Valves (located on the left-hand front air bag) in the COUNTER-CLOCKWISE (Deflate) position.

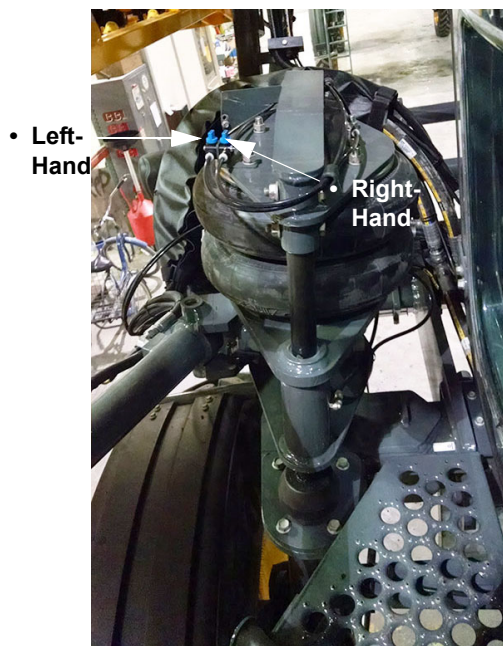

Air Suspension Valves  
(Located on the left-hand front air bag)  
-Typical View

3. Disengage the Quick-Tach Lock Assemblies by pulling the Lock Pins (located on the front left and right-hand side of machine) OUT as far as it will go until it is in the “lock-out” position.

*NOTE: “Lock-out” position prevents re-locking while attaching or detaching the attachment.*



Lock Pin (2)  
(Located on the front left and right-hand side of machine)  
-Typical View  
*\* Disengaged position shown*

4. Slowly pull into the DTB attachment.
5. Ensure the Attachment Hooks are high enough to clear the Mounting Pins.

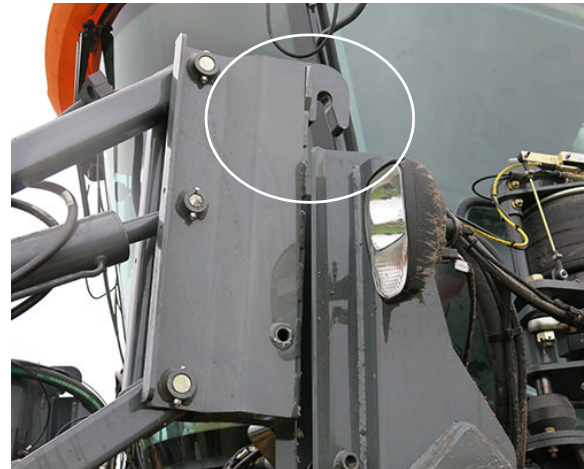

Attachment Clearing Mounting Pin  
-Typical View

6. Raise the machine and engage Attachment Hooks by rotating the corresponding Air Suspension Valves in the CLOCKWISE (Inflate) position.

*NOTE: Raising the machine will allow the weight of the attachment to pull the Attachment Hooks over the Mounting*

## SECTION 5 – MISCELLANEOUS



*Pins. You will notice a change of weight as the machine begins to support the attachment.*

- Engage the Quick-Tach Lock Assemblies by pushing the Lock Pins IN, ensuring full engagement.

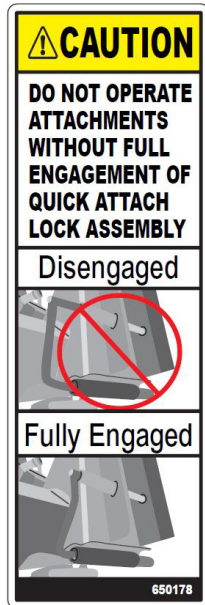

Lock Pin (2)  
-Typical View

*\* Engaged position shown*

- Engage the parking brake.
- Turn the engine OFF before connecting any hoses or electrical lines!**
- Install the Hydraulic/Electric Connection (located on the left-hand side of DTB attachment) into the Multi-Coupler

Receptacle (located on left-hand side of machine), ensuring full engagement.



Hydraulic/Electric Multi-Coupler Assembly  
(Left-hand side of machine shown)

- Push the Quick Connect Handle OUT to engage left-hand hydraulic/electrical connections.
- Press and hold the red Release Button (located on the right-hand quick connect handle) and lower handle into DOWN position.
- Remove the Hydraulic Connection Cover (located on right-hand side of machine) and set aside.

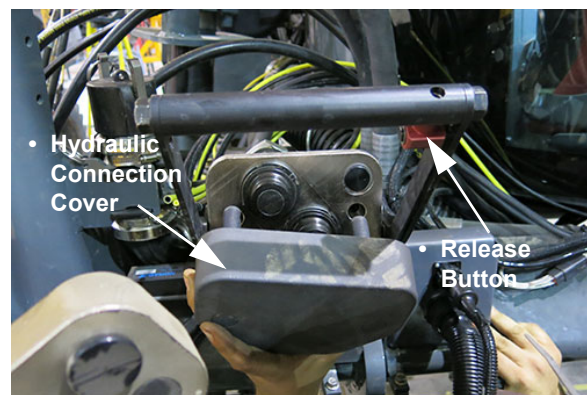

Hydraulic Connection Cover and Release Button  
(Right-hand side of machine shown)  
-Typical View

- Install the Hydraulic Connection (located on the right-hand side of DTB attachment) into the Multi-Coupler Receptacle (located on right-hand side of machine), ensuring full engagement.

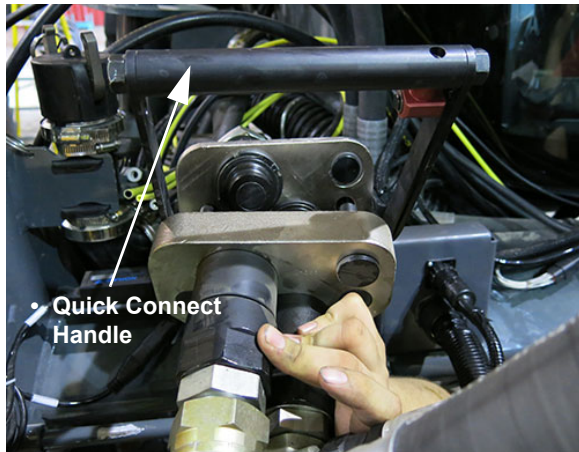

Hydraulic Multi-Coupler Assembly  
(Right-hand side of machine shown)  
-Typical View

15. Press and hold the red Release Button and push Quick Connect Handle UP to engage right-hand hydraulic connections.
16. Remove the Securement Pins (located on the inward side of each DTB attachment stand) and set aside.

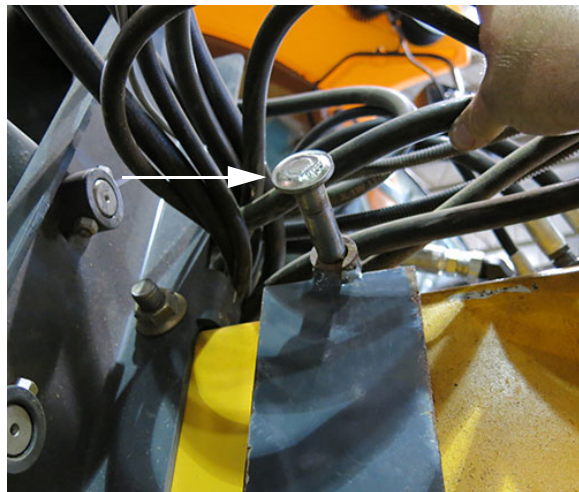

Securement Pin  
(Located on the inward side of  
each DTB attachment stand)  
-Typical View

17. Remove the Stop Plate (located on the inward side of each DTB attachment stand) and set aside.



Stop Plate  
(Located on the inward side of  
each DTB attachment stand)  
-Typical View

18. Remove the DTB attachment stands and set aside.

### **Disconnecting the Detasseler Tool Bar Attachment**

#### **NOTICE**

Stagger detasseling heads before folding the outriggers. Failure to comply will result in property damage.

#### **⚠ WARNING**

Ensure DTB attachment is in the fully FOLDED position before detaching from machine. Failure to comply may result in serious injury or death and will result in property damage.

Before disconnecting the DTB attachment, determine a proper storage location. When choosing a place to store the attachment, there are three important things to keep in mind:

## SECTION 5 – MISCELLANEOUS



### Is the ground level?

The ground must be level to help prevent the attachment from falling over. Level ground will also minimize stress on the frame of the attachment when in storage.

### Is there enough space?

Be aware of the room that is needed for the attachment and adequate space to travel around it safely.

### Is it accessible?

The attachment needs to be positioned so you can connect easily. Ensure there is enough room and that the attachment is not blocked, or blocking other items.

If temporarily storing attachment on a soft surface (such as grass), it is recommended to place blocks or wood beneath each of the DTB attachment stands to prevent the attachment from sinking into the ground.

*NOTE: It is NOT recommended to store the attachment on a soft surface for an extended period of time, due to the risk of settling soil, even when blocks or wood are used.*

## NOTICE

Stagger detasseling heads before folding the outriggers. Failure to comply will result in property damage.

1. Press the Attachment Button (located on the Machine Display Main Menu).



Attachment Button  
(Located on the Machine Display Main Menu)

2. PREP TO FOLD - Press the Prep Button (located on the Machine Display “DTB Lifts/Motors” screen OR the “DTB Depth Command” screen).

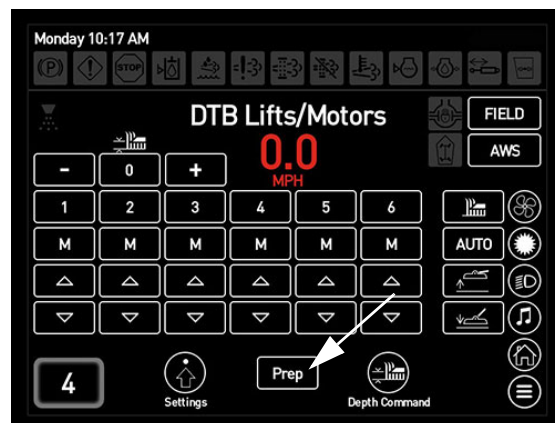

Prep Button  
(Located on the Machine Display DTB Lifts/Motors Screen or DTB Depth Command Screen)

3. Press BOTH left and right-hand Level Switches (located on the Hydrostatic Drive Control Handle) either UP or DOWN simultaneously. The tool bar will then adjust the lifts and the depth command actuators will position to allow folding.



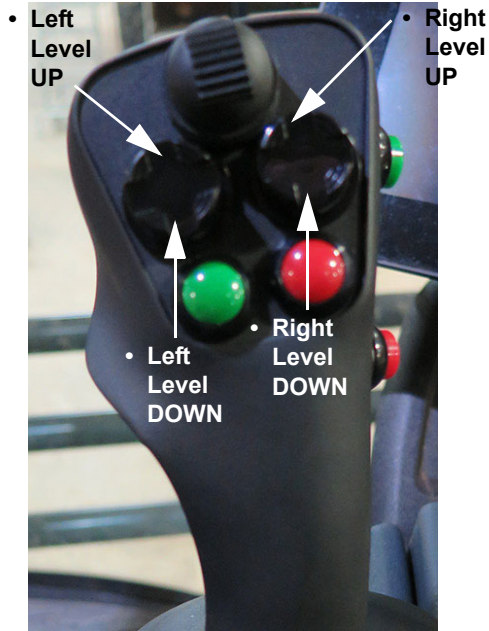

Level Switches - Left/Right  
(Located on the Hydrostatic  
Drive Control Handle)  
-Typical View

*NOTE: Once the tool bar is prepped to fold, a “DTB Prep to Fold Complete” message will appear on the display.*



Staggered Detasseling Heads  
-Typical View

Alternatively, if manual detasseling head staggering is desired, perform the following through the Machine Display. Refer to “Tasselrol™ XL/LS System 12” provided elsewhere in this manual for further information.

- Lower the two center detasseling heads all the way DOWN.

- Raise all the detasseling heads on one side to approximately half of the fully raised height.
  - Raise the detasseling heads on the opposite side to the fully raised height.
4. Slowly fold the outriggers in, making adjustments (as necessary) to the height of the detasseling heads.  
Refer to “Fold Procedure - Detasseler Tool Bar” elsewhere in this manual for further information.

### NOTICE

Do not attempt to make any adjustments to the detasseling heads after the outriggers are folded. Failure to comply may cause the stalk guides or depth command sensor bars to entangle, resulting in equipment damage.

5. Engage the parking brake.
6. **Turn the engine OFF before disconnecting any hoses or electrical lines!**
7. Install the DTB attachment stands beneath attachment.
8. Install Stop Plate and Securement Pin on the inward side of each DTB attachment stand.



Stop Plate/Securement Pin Assembly  
-Typical View

9. Push the Quick Connect Handle (located on the left-hand side of machine) IN to disengage hydraulic/electrical connections.

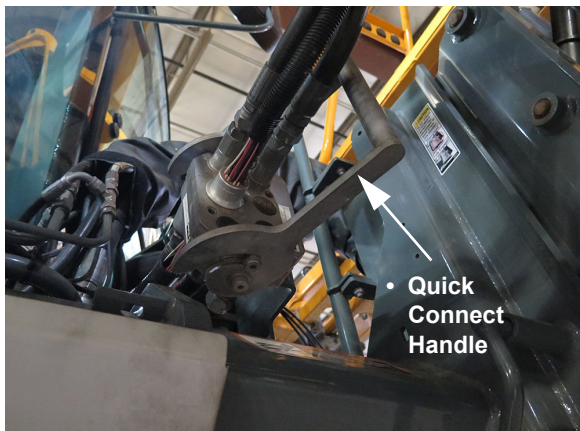

Hydraulic/Electric Multi-Coupler Assembly  
(Left-hand side of machine shown)

10. Remove Hydraulic/Electric Connection from the Multi-Coupler Receptacle.
11. Press and hold the red Release Button (located on the right-hand quick connect handle) and pull handle DOWN to disengage hydraulic connections.

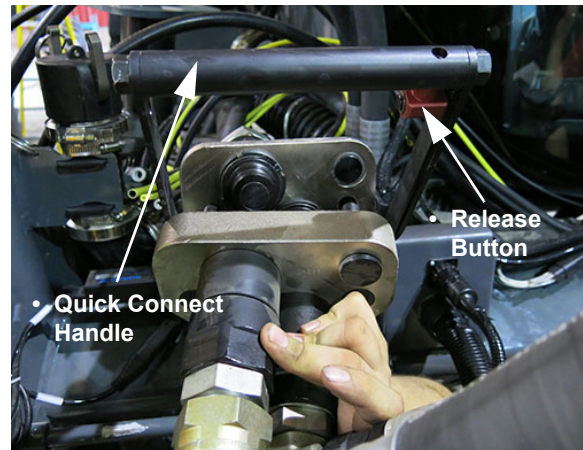

Hydraulic Multi-Coupler Assembly  
(Right-hand side of machine shown)  
-Typical View

12. Remove Hydraulic Connection from the Multi-Coupler Receptacle.
13. Reinstall Hydraulic Connection Cover (located on right-hand side of machine).



Hydraulic Connection Cover  
(Right-hand side of machine shown)  
-Typical View

14. Disengage the Quick-Tach Lock Assemblies by pulling the Lock Pin (located on the front left and right-hand side of machine) OUT as far as it will go until it is in the “lock-out” position.

*NOTE: “Lock-out” position prevents re-locking while attaching or detaching the attachment.*



Lock Pin (2)  
(Located on the front left and  
right-hand side of machine)  
-Typical View  
*\* Disengaged position shown*

15. Start the engine.
16. Lower the machine by rotating the corresponding Air Suspension Valves (located on the left-hand front air bag) in the COUNTER-CLOCKWISE (Deflate) position.

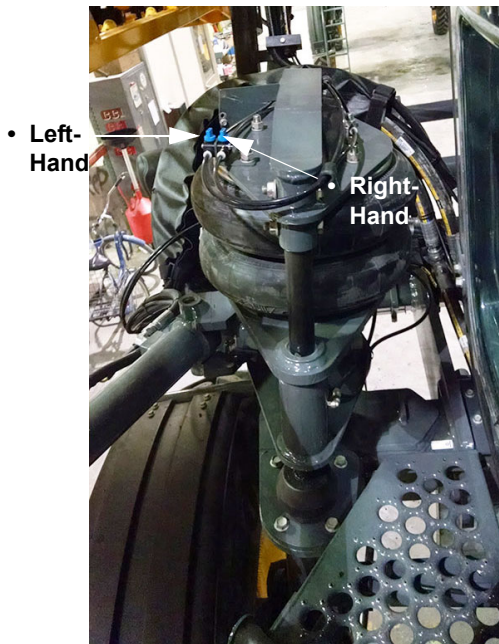

Air Suspension Valves  
(Located on the left-hand front air bag)  
-Typical View

17. Disengage the parking brake and slowly back away from the DTB attachment.
18. If no other attachment is going to be installed, re-lock the Quick-Tach Lock Assemblies by pushing the Lock Pins IN.

*NOTE: Install provided covers on disconnection points to avoid damage and contamination. Contact your local John Deere dealer for replacement covers.*

19. Raise the machine by rotating the corresponding Air Suspension Valves in the CLOCKWISE (Inflate) position.

## ATTACHMENT ASSEMBLY

### Cutter Heads, Quad Pullers, and LS (Light Sensing) System/Depth Command

#### **⚠ CAUTION**

Engage the parking brake and turn the engine OFF before installing components.

#### **NOTICE**

Read and comply with the following attachment instructions. Ensure you have the proper equipment and assistance when installing an attachment.

To ensure proper component installation, refer to your Parts Manual for outlining the installation, hydraulic schematic, and wiring diagrams.

*NOTE: Refer to your Parts Manual for correct hardware used when performing the following attachment procedures.*

**Cutter Head Assembly**



**CAUTION**

SEVERING OF FINGERS OR HAND.  
DO NOT PLACE FINGERS OR  
HAND NEAR A MOVING CUTTER BLADE,  
ATTEMPT TO STOP A MOVING CUTTER  
BLADE, OR PERFORM MAINTENANCE  
NEAR A MOVING CUTTER BLADE.

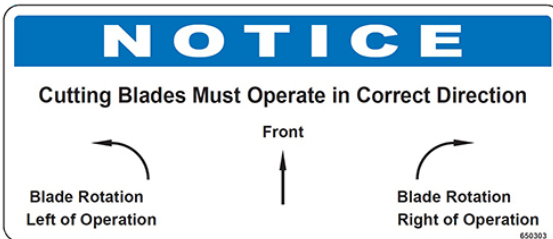

*NOTE: Refer to your Parts Manual for specific hardware used.*

1. Install two (2) Cutter Heads on each lift head tube, as shown.

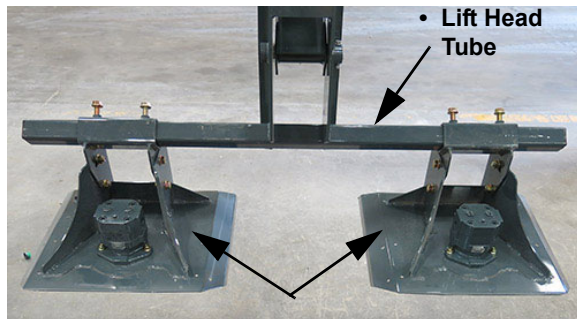

Cutter Heads  
-Typical View

2. Ensure each Cutter Head measures 16” (40.6 cm) from the outside of the mount head to the outside of the cutter head mounting tube, making adjustments as necessary.

*NOTE: Distance may vary depending on planting pattern.*

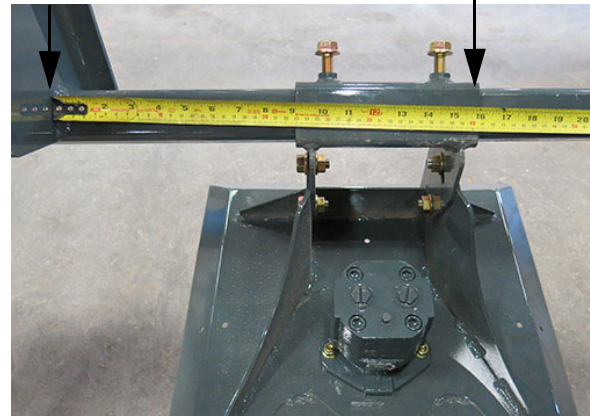

- Measure 16” (40.6 cm) from the outside of the mount head to the outside of the cutter head mounting tube

3. Ensure each Cutter Head measures 30” (76.2 cm) from center of each cutter head motor.

*NOTE: Distance may vary depending on planting pattern.*

*NOTE: Repeat process, measuring across each lift mount.*



- Measure 30” (76.2 cm) from center of each cutter head motor



- Measure 30” (76.2 cm) from center of each cutter head motor, across each lift mount

4. Using a 3/4" socket, tighten each Cutter Head Bolt (two on each Cutter Head Mounting Tube).



Cutter Head Bolts  
(Located on each  
Cutter Head Mounting Tube)  
-Typical View

5. Install two Stalk Guides on each Cutter Head, positioned as shown.

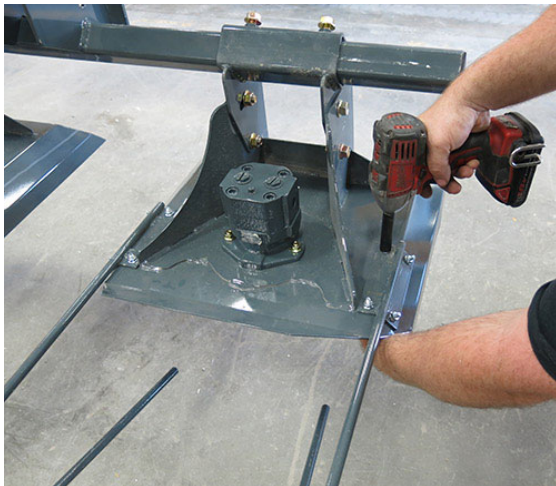

- Install eight (8) Stalk Guide Bolts (4 each side) through bottom of each Cutter Head/Stalk Guide.
- Install eight (8) Stalk Guide Nuts (4 each side) onto the bolts and tighten with a 7/16" socket.



Stalk Guide Installation  
-Typical View

6. Apply anti-seize lubricant to inside of Cutter Blade Adapter Plug.

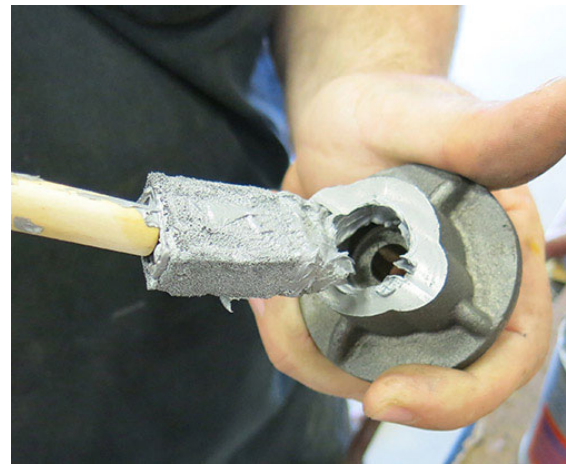

Anti-Seize Lubricant Application  
-Typical View

7. Install Cutter Blade Adapter Plug onto center of blade.

*NOTE: Ensure adapter plug is installed on the "edged" side of blade, as shown.*



- Install Cutter Blade Adapter Plug onto center of blade

## SECTION 5 – MISCELLANEOUS



- Assemble Retaining Bolt, Lock Washer, and Steel Washer together, as shown.

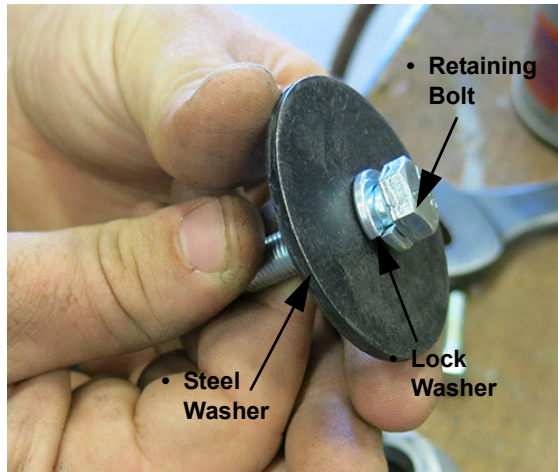

Cutter Blade Bolt/Washer Assembly  
-Typical View

- Insert Cutter Blade Bolt/Washer Assembly through bottom of blade/adaptor plug.



Cutter Blade Assembly  
-Typical View

- Install Cutter Blade Assembly through bottom side of Cutter Head (as shown) and tighten Retaining Bolt using a 9/16" socket. Torque to 37 ft.-lbs.

*NOTE: Inspect and tighten Retaining Bolts daily.*



Cutter Blade Assembly  
(Mounted on the bottom  
side of Cutter Head)  
-Typical View

*NOTE: Repeat Steps 6-10 for each Cutter Head.*

- Install Cutter Head Extension Flap on the rear side of the center four (4) Cutter Heads.



Cutter Head Extension Flap  
-Typical View

- Install hydraulic connections on each Cutter Head.

*NOTE: Refer to your Parts Manual for correct hardware, hose lengths, and hydraulic schematics.*



Cutter Head Hydraulic Connections  
-Typical View

### Quad Puller Assembly

*NOTE: Some Quad Pullers may come pre-assembled to the tool bar.*



**CAUTION**

RISK OF INJURY FROM ROTATING TIRES.  
DO NOT PLACE FINGERS OR HAND NEAR  
MOVING QUAD PULLER TIRES, DISLodge A  
WEDGED OBJECT FROM MOVING TIRES, OR  
PERFORM MAINTENANCE NEAR MOVING TIRES.

**NOTICE**

Ensure quad puller tires have equal  
pressure. Check tire pressure daily.

*NOTE: Refer to your Parts Manual for  
specific hardware used.*

1. Install two (2) Quad Pullers on each lift head tube, as shown.



Quad Puller  
-Typical View

2. Ensure each Quad Puller measures 16" (40.6 cm) from the outside of the mount head to the outside of the quad puller mounting tube, making adjustments as necessary.

*NOTE: Distance may vary depending on  
planting pattern.*

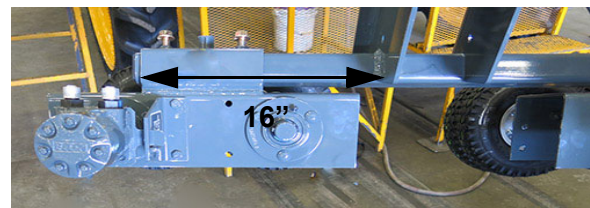

- Measure 16" (40.6 cm) from the outside of the mount head to the outside of the quad puller mounting tube

3. Using a 3/4" socket, tighten each Quad Puller Bolt (two on each Quad Puller Mounting Tube).

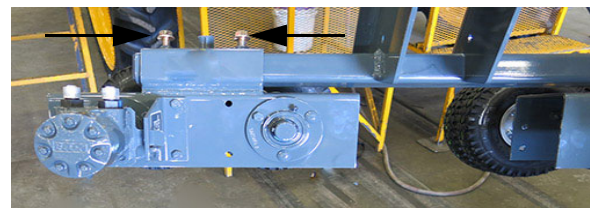

Quad Puller Bolts  
(Located on each  
Quad Puller Mounting Tube)  
-Typical View

4. Install two Stalk Guides onto each Quad Puller, positioned as shown.
  - Install four (4) Stalk Guide Bolts (2 each side) through the front side of each Stalk Guide/Quad Puller.

## SECTION 5 – MISCELLANEOUS



- Install four (4) Stalk Guide Nuts (2 each side) onto the bolts and tighten with a 9/16" socket.

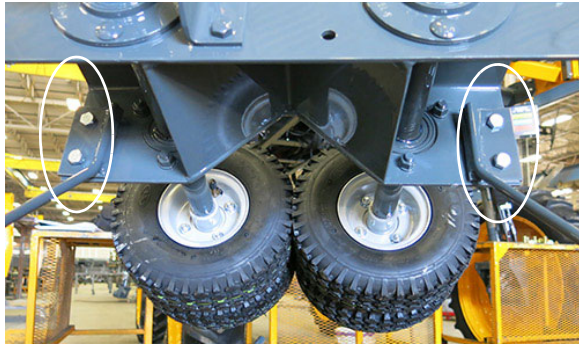

- Install four (4) Stalk Guide Bolts through the front side of each Stalk Guide/Quad Puller

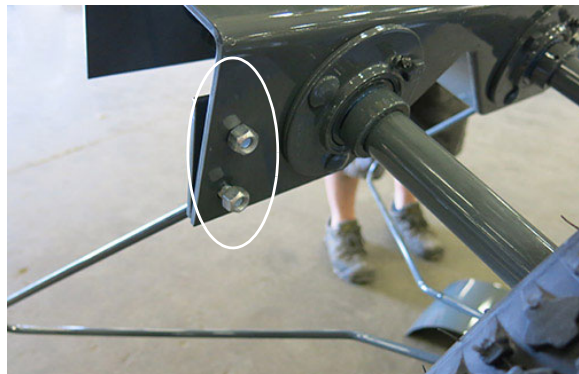

- Install four (4) Stalk Guide Nuts onto the bolts and tighten with a 9/16" wrench



Stalk Guide Installation  
-Typical View

5. Install Deflector Shield Mounting Tube onto each Quad Puller (as shown) and tighten bolts with 7/16" wrench.



Deflector Shield Mounting Tube  
-Typical View

6. Install Deflector Shield onto Deflector Shield Mounting Tube and tighten bolts with 1/2" wrench.

*NOTE: Always mount Deflector Shields to direct tassels away from machine.*

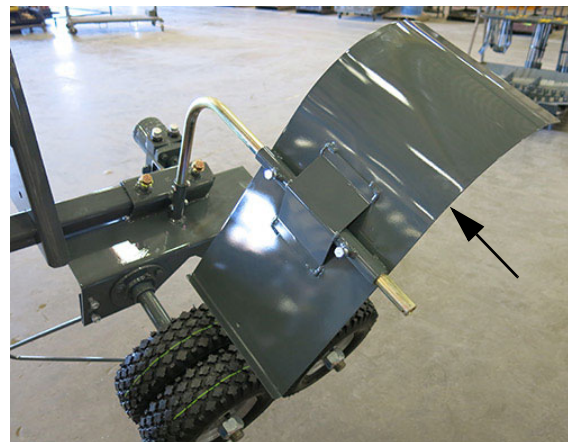

Deflector Shield  
-Typical View

7. Install Cotter Pin on the end of each Deflector Shield Mounting Tube.





Cotter Pin  
-Typical View

8. Install hydraulic connections on each Quad Puller.

*NOTE: Refer to your Parts Manual for correct hardware, hose lengths, and hydraulic schematics.*

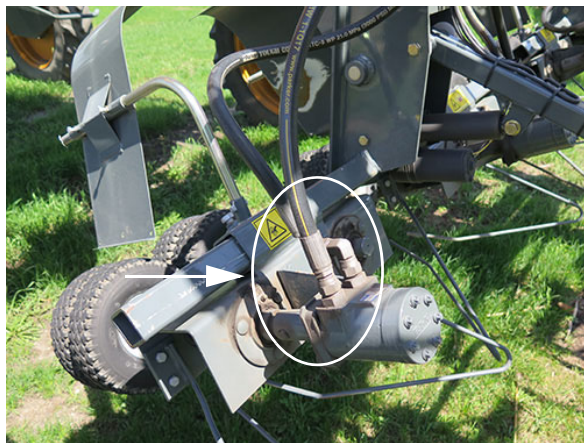

Quad Puller Hydraulic Connections  
-Typical View

9. Adjust tire pressure to approximately 10 psi (.7 bar).

## LS (Light Sensing) System/ Depth Command Assembly

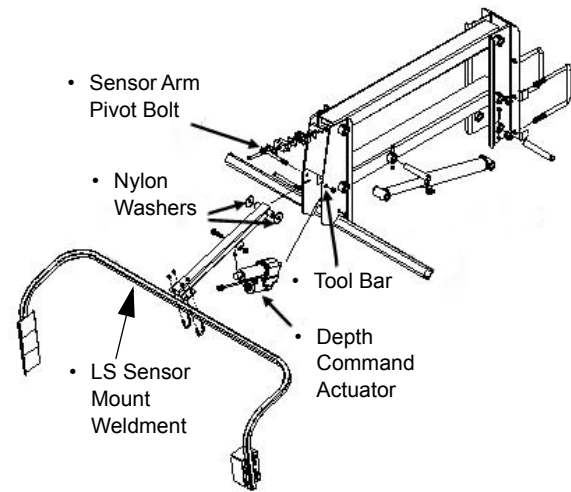

-Typical View

1. Install the LS Sensor Mount Weldment with the two Nylon Washers in the forward-most hole of the Tool Bar.
2. Install the LS Sensor Mount Weldment to the Sensor Mount (located on the support arm).
3. Install the Cable Assembly according to the wiring diagram provided in your Parts Manual.
4. Check sensor installation by turning the ignition key to the ON position. **DO NOT** start the engine.
5. Attach the Depth Command Actuator to the Light Sensor Mount and Tool Bar.

### **NOTICE**

Over-tightening of the Sensor Arm Pivot Bolt may cause the actuator to stall.

## TROUBLESHOOTING

Problem	Possible Cause	Suggested Remedy
Lifting mechanism will not lift	<ul style="list-style-type: none"> <li>• Bad cylinder</li> <li>• Blown relief valve</li> <li>• Relief valve set too low</li> <li>• Lift arms seized</li> <li>• Faulty electro-hydraulic valve</li> </ul>	<ul style="list-style-type: none"> <li>• Check cylinder - remove and rebuild or replace</li> <li>• Remove, inspect, replace</li> <li>• Contact your local John Deere dealer for assistance</li> <li>• Loosen mounting bolts, lubricate grease fittings (if equipped)</li> <li>• Contact your local John Deere dealer for assistance</li> </ul>
Cutter head blades, quad pullers, rollers, or ties will not turn	<ul style="list-style-type: none"> <li>• Oil level in reservoir too low</li> <li>• Oil not reaching pump</li> <li>• Faulty hydraulic pump</li> <li>• Faulty hydraulic motor(s)</li> </ul>	<ul style="list-style-type: none"> <li>• Fill reservoir to proper level with approved oil</li> <li>• Remove suction hose from pump and check for proper flow, reinstall hose and all suction fittings</li> <li>• Replace hydraulic pump</li> <li>• Replace motor(s)</li> </ul>
Hydraulic motor leaking	<ul style="list-style-type: none"> <li>• Seal failure</li> <li>• Restricted case drain hose</li> </ul>	<ul style="list-style-type: none"> <li>• Replace seal, turn heads on with low engine RPM</li> <li>• Inspect or replace hose</li> </ul>
No units will lift	<ul style="list-style-type: none"> <li>• Oil in hydraulic reservoir low</li> <li>• Faulty valve</li> <li>• Relief valve in electro-hydraulic valve set too low</li> </ul>	<ul style="list-style-type: none"> <li>• Fill reservoir to proper level</li> <li>• Repair or replace valve</li> <li>• Contact your local John Deere dealer for assistance</li> </ul>
No units will lower	<ul style="list-style-type: none"> <li>• Lift arm pivots too tight</li> </ul>	<ul style="list-style-type: none"> <li>• Lubricate and loosen pivot points</li> </ul>
Only one unit will not lower	<ul style="list-style-type: none"> <li>• Faulty valve</li> <li>• Lift arm pivot too tight</li> </ul>	<ul style="list-style-type: none"> <li>• Replace valve</li> <li>• Lubricate and loosen pivot point</li> </ul>
All units lift slowly	<ul style="list-style-type: none"> <li>• Hydraulic oil not at operating temperature</li> <li>• Faulty valve</li> <li>• Lift arm pivots too tight</li> <li>• Relief valve in electro-hydraulic valve system set too low</li> </ul>	<ul style="list-style-type: none"> <li>• Allow time for oil to warm up</li> <li>• Replace valve</li> <li>• Lubricate and loosen pivot points</li> <li>• Contact your local John Deere dealer for assistance</li> </ul>
Only one unit lifts slowly	<ul style="list-style-type: none"> <li>• Faulty valve</li> <li>• Lift arm pivot points too tight</li> </ul>	<ul style="list-style-type: none"> <li>• Replace valve</li> <li>• Lubricate/loosen pivot points</li> </ul>



## SECTION 5 – MISCELLANEOUS

Only one unit will not hold position	<ul style="list-style-type: none"><li>• Oil leak between valve and cylinder</li><li>• Faulty valve</li><li>• Faulty lower poppet on lift valve</li></ul>	<ul style="list-style-type: none"><li>• Repair leak or replace hose</li><li>• Replace valve</li><li>• Remove, clean/replace</li></ul>
No units will hold position	<ul style="list-style-type: none"><li>• Non-hydraulic issue</li></ul>	<ul style="list-style-type: none"><li>• Adjust Response Parameter, Bottom Parameter, Top Parameter, and/or Auto Speed</li></ul>
Only one unit lowers slowly	<ul style="list-style-type: none"><li>• Faulty valve</li><li>• Faulty lower poppet on lift valve</li></ul>	<ul style="list-style-type: none"><li>• Replace valve</li><li>• Remove, clean/replace</li></ul>
All units lower slowly	<ul style="list-style-type: none"><li>• Hydraulic oil not at operating temperature</li></ul>	<ul style="list-style-type: none"><li>• Allow time for oil to warm up</li></ul>
In MANUAL mode, more than one unit lifts or lowers using one up/down switch	<ul style="list-style-type: none"><li>• Faulty valve</li></ul>	<ul style="list-style-type: none"><li>• Replace valve</li></ul>

**SECTION 5 –  
MISCELLANEOUS**



In AUTO mode, more than one unit raises from photo sensor	<ul style="list-style-type: none"> <li>• Faulty valve</li> </ul>	<ul style="list-style-type: none"> <li>• Replace valve</li> </ul>
In AUTO mode, wrong unit raises from photo sensor	<ul style="list-style-type: none"> <li>• Cylinder hoses are connected to the wrong cylinder</li> <li>• Electronic malfunction</li> </ul>	<ul style="list-style-type: none"> <li>• Attach correct hoses to proper cylinder</li> <li>• Contact your local John Deere dealer for assistance</li> </ul>
No units will lift	<ul style="list-style-type: none"> <li>• Blown Fuse</li> <li>• Faulty #1 valve, coil, or loose coil mounting nut</li> <li>• Loose wire connections</li> <li>• Faulty wire connections</li> <li>• Faulty main wire assembly</li> </ul>	<ul style="list-style-type: none"> <li>• Find short in wire, repair, and replace fuse</li> <li>• Tighten or replace coil</li> <li>• Find loose connection, tighten</li> <li>• Replace or repair</li> <li>• Replace or repair</li> </ul>
Only one unit will not lift	<ul style="list-style-type: none"> <li>• Light photo sensor assembly</li> <li>• Faulty valve, coil, or loose coil mounting nut</li> <li>• Loose wire connections</li> <li>• Photo sensor lights not lined up with reflector</li> <li>• Faulty row wire assembly</li> <li>• Faulty sensor connector wire</li> </ul>	<ul style="list-style-type: none"> <li>• Replace photo sensor</li> <li>• Tighten nut or replace coil</li> <li>• Find loose connections, tighten</li> <li>• Line up sensor with reflector</li> <li>• Replace or repair</li> <li>• Replace or repair</li> </ul>
No units will lower	<ul style="list-style-type: none"> <li>• Blown fuse</li> <li>• In AUTO mode, LS valve assembly unplugged</li> <li>• Loose wire connection</li> </ul>	<ul style="list-style-type: none"> <li>• Find short in wire, repair, and replace fuse</li> <li>• Plug in wire assembly</li> <li>• Find loose connection, tighten</li> </ul>
Only one unit will not lower	<ul style="list-style-type: none"> <li>• Light photo sensor inoperable</li> <li>• Faulty valve, coil, or loose coil mounting nut</li> <li>• Loose wire connection</li> <li>• Lights of photo sensor not lined up with reflector</li> <li>• Faulty row wire assembly</li> <li>• Faulty sensor connector wire assembly</li> </ul>	<ul style="list-style-type: none"> <li>• Replace photo sensor</li> <li>• Tighten nut or replace coil</li> <li>• Find loose connection, tighten</li> <li>• Line up sensor with reflector</li> <li>• Replace or repair</li> <li>• Replace or repair</li> </ul>
No units will hold position	<ul style="list-style-type: none"> <li>• In AUTO mode, no crop moving under assemblies</li> </ul>	<ul style="list-style-type: none"> <li>• Drive forward or select MANUAL mode</li> </ul>
In AUTO mode, wrong unit raises from sensor assembly	<ul style="list-style-type: none"> <li>• Row LS wire assembly plugged into wrong sensor connector</li> </ul>	<ul style="list-style-type: none"> <li>• Plug correct wire assembly into proper row sensor connector assembly</li> </ul>



---

A Word From Hagie Manufacturing	
Company .....	1-1
About This Manual .....	1-1
Attachment Assembly .....	5-10
Detasseling System - Operation .....	3-9
Detasseling System Components .....	3-1
Fold Procedure - Detasseler Tool Bar ...	3-6
Identification .....	1-3
Intended Use .....	2-1
Operator Presence Switch (OPS) .....	2-3
Product Warranty .....	1-3
Quick-Tach System - Detasseler	
Tool Bar .....	5-3
Safety Decals .....	2-4
Safety Messages Used In This	
Manual .....	1-2
Safety Precautions .....	2-1
Service - Lubrication .....	4-1
Service and Assistance .....	1-2
Service Intervals .....	4-3
Specifications .....	1-4
Storage .....	4-4
Tasselrol™ XL/LS System 12 .....	3-11
Transporting .....	5-1
Troubleshooting .....	5-17

# NOTES

---

# NOTES

---

# NOTES

---