

**2018 DETASSELER TOOL BAR
OPERATOR'S MANUAL
493751**



HAGIE
CONTENTS

1 – INTRODUCTION

A Word From Hagie Manufacturing Company	1-1
About This Manual	1-1
Safety Messages Used In This Manual	1-2
Service and Assistance	1-2
Product Warranty	1-2
Identification	1-2
Specifications	1-4

2 – SAFETY AND PRECAUTIONS

Intended Use	2-1
Safety Precautions	2-1
Operator Presence Switch (OPS)	2-3
Safety Decals	2-4

3 – OPERATING YOUR DTB

Detasseling System Components	3-1
Fold Procedure - Detasseler Tool Bar	3-6
Detasseling System - Operation	3-8
4-2 Detasseler Attachment - Adjustable	3-10
Tasseltrol®/LS System 12™	3-13
Tasseltrol Flowchart	3-22

4 – MAINTENANCE AND STORAGE

Service - Lubrication	4-1
Service Intervals	4-3
Storage	4-4

5 – MISCELLANEOUS

Transporting	5-1
Quick-Tach System - Detasseler Tool Bar	5-3
Attachment Assembly	5-10
Troubleshooting	5-17



SECTION 1 – INTRODUCTION

A WORD FROM HAGIE MANUFACTURING COMPANY

Congratulations on the purchase of your Detasseler Tool Bar (DTB) attachment! We recommend that you review this operator's manual and become familiar with operating procedures and safety precautions before attempting to operate your DTB.

As with any piece of equipment, certain operating procedures, service, and maintenance are required to keep your DTB in top running condition. We have attempted herein to cover all of the adjustments required to fit varying conditions. However, there may be times when special care must be considered.

NOTE: The user is responsible for inspecting the attachment and having parts repaired or replaced when continued use of the product causes damage or excessive wear to other parts.

Hagie Manufacturing Company reserves the right to make changes in the design and material of any subsequent DTB without obligation to existing attachments.

Thank you for choosing a Hagie DTB and we ensure you of our continued interest and support in its optimal performance for you. We are proud to have you as a customer!

ABOUT THIS MANUAL

NOTICE

The purpose of this manual is to guide you in the proper operation of the DTB attachment, as well as provide you with pertinent safety precautions and maintenance information. This manual is intended to cover the DTB attachment only and any differences in the operation of the sprayer controls. Refer to your sprayer operator's manual and all other literature that is included with the machine for complete instructions on machine operation.

NOTICE

Any pictures or illustrations contained within this manual that depict situations with shields, guards, rails, or lids removed are for demonstration only. Keep all shields and safety devices in place at all times.

This manual will aid you in the proper operation and service of your DTB attachment. It is the responsibility of the user to read the operator's manual and comply with the correct and safe operating procedures, as well as maintain the product according to the service information provided in the *Maintenance and Storage Section* elsewhere in this manual.

Photographs and illustrations used in this manual are of general nature only. Some of the equipment described and/or shown may or may not be available on your attachment.

Information described in this manual was correct at the time of printing. Because of Hagie Manufacturing Company's continuous product improvement, certain information may not be

included in this manual. To obtain the most current operator's manual for your attachment, please visit www.hagie.com.

Keep this manual in a convenient place for easy reference. This manual is considered a permanent fixture of the product. In the event of resale, this manual must accompany the DTB.

If you do not understand any part of this manual or require additional information or service, contact your local John Deere dealer for assistance.

SAFETY MESSAGES USED IN THIS MANUAL

The following safety messages found throughout this manual alert you of situations that could become potentially dangerous to the operator, service personnel, or equipment.



DANGER

The signal word DANGER indicates a hazardous situation which, if not avoided, will result in death or serious injury.



WARNING

The signal word WARNING indicates a hazardous situation which, if not avoided, could result in death or serious injury.



CAUTION

The signal word CAUTION indicates a hazardous situation which, if not avoided, could result in minor or moderate injury. CAUTION may also be used to alert against unsafe practices associated with events which could lead to personal injury.



NOTICE

The signal word NOTICE indicates operator awareness which, if not avoided, may result in personal or property damage.

NOTE: A "Note" is intended to make special mention of, or remark on.

SERVICE AND ASSISTANCE

Please contact your local John Deere dealer for service and assistance.

PRODUCT WARRANTY

Please contact your local John Deere dealer for further information.

IDENTIFICATION



NOTICE

Reference to right and left-hand used throughout this manual refers to the position when seated in the operator's seat facing forward.

SECTION 1 – INTRODUCTION



The DTB attachment has an identification plate mounted on the main tool bar that provides attachment model and serial number.



DTB Identification Plate
-Typical View



DTB Identification Plate Location
(Located on the main tool bar)
-Typical View

SPECIFICATIONS

NOTE: Dimensions may vary, depending on tire size.

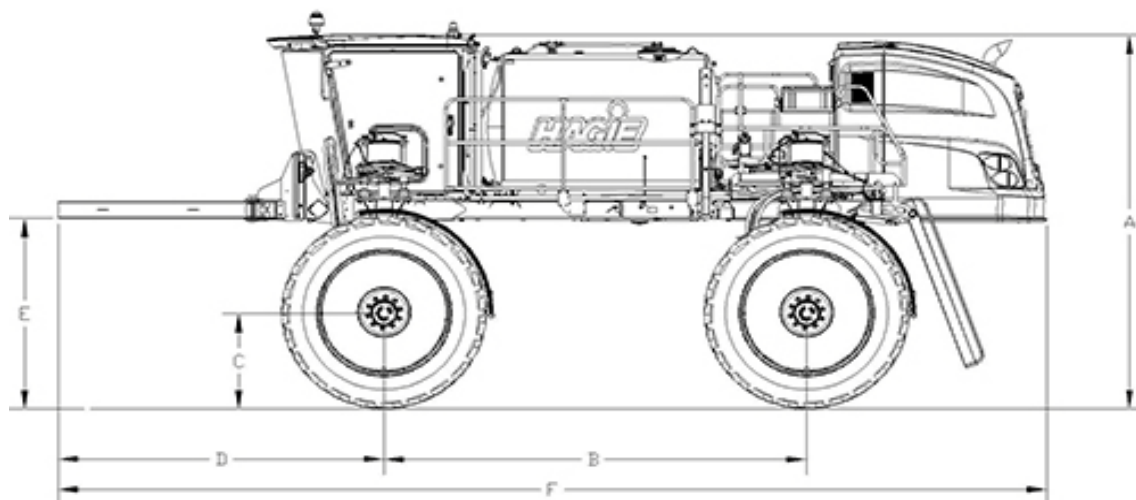

Detail	Description	Specification
A	Overall Machine Height (from top of cab) <i>NOTE: Overall machine height dimension does not include the cab-mounted rotating beacon or the optional GPS unit.</i>	154"/391.2 cm **
B	Wheel Base	<ul style="list-style-type: none"> • 140"/355.6 cm (Short Frame) • 166"/421.6 cm (Long Frame)
C	Static Loaded Hub Height	38 3/8"/97.5 cm **
D	Length (from front of tool bar to center of wheel hub)	<ul style="list-style-type: none"> • 80.5"/204.5 cm (6 Row) • 128.5"/326.4 cm (8-10 Row) • 186.5"/473.7 cm (12-18 Row)
E	Height (from bottom of tool bar to ground)	75.75"/192.4 cm **
F	Overall Machine Length (from front of tool bar to rear hood)	<ul style="list-style-type: none"> • 315.5"/801.4 cm (6 Row, Short Frame) • 341.5"/867.4 cm (6 Row, Long Frame) • 363.5"/923.3 cm (8-10 Row, Short Frame) • 389.5"/989.3 cm (8-10 Row, Long Frame) • 421.5"/10 m (12-18 Row, Short Frame) • 447.5"/11 m (12-18 Row, Long Frame)
G	Overall Width (boom cradles)	153"/388.6 cm
H	Frame Clearance (to tread adjust bolts)	76"/193 cm **
I	Lower Leg Clearance (from shield)	31"/78.7 cm **
J	Tread Width *	<ul style="list-style-type: none"> • 120"/304.8 cm (In) ** • 160"/406.4 cm (Out) **

* Tread width is measured from center of tire at ground.

** Refer to “Tire Specifications” provided in the machine operator’s manual for a complete listing of tire options when configuring specifications on your model.

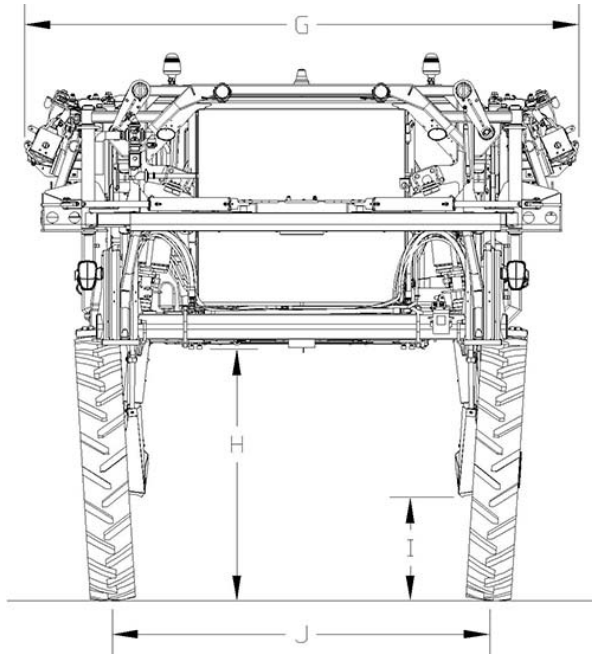

General Information

NOTICE

Because Hagie Manufacturing Company offers a variety of options, the illustrations in this manual may show a machine equipped other than standard. Machine dimension and weight values may vary, depending on available equipment.

- **Frame Type:** 4x8” (10.2x20.3 cm) modular platform frame
- **Suspension:** 4-wheel, individual, auto air-ride
- **Shipping Width:** 153”/388.6 cm (90/100’ boom cradles)
- **Approximate Dry Weight:** 3,204 lbs./1,453 kg (8-10 row tool bar)

Description	Specification
General	
Monitors/Controls	<ul style="list-style-type: none"> • Detasseling Control Panel • Tasselrol®/LS System 12™ Control Panel
General System	Light sensing system, depth command, electrical disconnect, hydraulic couplers
Outriggers	
12-Row	134"/340.4 cm (1 left, 1 right)
8-Row	75"/190.5 cm (1 left, 1 right)
Quad Pullers	
Number of Rows Available	6, 8, 10, or 12
Drive	Hydraulic
Tire Size	4.10/3.50 2-ply
Tire Pressure	10 PSI/.7 bar
Operating Speed	Up to 400 RPM
Pulling Height	<ul style="list-style-type: none"> • Minimum Range = 32-97" (81.3-246.4 cm) • Maximum Range = 40-105" (101.6-266.7 cm)
Weight (per assembly)	86 lbs. (39 kg)
Cutter Heads	
Number of Rows Available	6, 8, 10, or 12
Drive	Hydraulic
Blade Size	18"/45.7 cm
Operating Speed	Up to 3100 RPM
Cutting Height	<ul style="list-style-type: none"> • Minimum Range = 29-94" (73.7-238.8 cm) • Maximum Range = 13-102" (33-259.1 cm)
Weight (per assembly)	62 lbs. (28 kg)



SECTION 2 – SAFETY AND PRECAUTIONS

INTENDED USE

NOTICE

This attachment is designed for and intended to be used for the removal of tassels from the tops of corn plants. Use in any other way or for any other purpose is considered misuse of this attachment.

Most accidents occur as the result of failure to follow basic and fundamental safety rules and precautions. Recognizing potential safety hazards, following correct and safe operating procedures described in this manual, and complying with safety warnings located throughout the machine and attachment may reduce the risk of accidents.

There is no way to completely eliminate the potential for danger when operating agricultural equipment. Therefore, you must study this operator's manual and understand how to operate the attachment controls for safe operation before using the attachment. Likewise, never let anyone operate the attachment without proper instruction.

Do not operate the attachment for anything other than its intended use. Hagie Manufacturing Company shall not be liable for any damage, injury, or death associated with improper use of the attachment.

Do not make any modifications such as, but not limited to, weldments, add-ons, adaptations, or changes from the original design of the attachment. Such modifications may become safety hazards to you and others and **will void all warranties**.

Replace missing, faded, or damaged safety signs. Refer to "Safety Decals" elsewhere in this section for correct sign and placement.

SAFETY PRECAUTIONS

General Safety

- Before operating the attachment, ensure there are no obstacles or persons in the path of travel.
- Keep clear of all moving parts and keep others away while operating.
- The hydraulic and electrical control systems are optimized for use with this attachment. Any modification to these systems may lead to unintended or uncontrolled motion. Do NOT install add-on control systems that are not approved by Hagie Manufacturing Company.
- Some conditions cannot be completely safeguarded against without interfering with efficient operation of the machine and/or reasonable accessibility. In these cases, decals have been installed to provide the operator with hazard information. Do NOT remove decals for any reason. If a decal is damaged or missing, contact your local John Deere dealer for replacement.



Wear Protective Clothing

- Do not wear loose fitting clothing that could get caught in moving parts. Wear safety equipment that is appropriate for the job.



- Do not store chemical-soaked clothing in the cab. Clean off as much mud and dirt from your shoes as you can before entering the cab.

Protect Against Noise

- Wear suitable hearing protection. Prolonged exposure to loud noise may result in loss of hearing.



Be Prepared

- Be prepared for an emergency. Keep a fire extinguisher, first aid kit, and clean water in the cab at all times.
- Service the fire extinguisher regularly.
- Keep an accurate inventory of supplies in the first aid kit and dispose of any items that have expired.



General Maintenance Safety

- Turn off sprayer engine before checking, adjusting, repairing, lubricating, or cleaning any part of the attachment.

- Disconnect the battery ground cable and turn the Battery Disconnect Switch OFF before servicing the electrical system or welding on the attachment.



Remove Accumulated Crop Debris

- The buildup of crop debris in the engine compartment, on the engine, or near moving parts is a fire hazard. Check and clean areas frequently. Before performing any inspection or service, engage the parking brake, shut off the engine, and remove the key.



Remove Paint Before Welding or Heating

- Avoid toxic fumes and dust. Hazardous fumes can be generated when paint is heated by welding, soldering, or using a torch.



- Do not use chlorinated solvents in areas where welding will take place.
- Perform all work in an area that is well ventilated to carry toxic fumes and dust away.

- Dispose of paint and solvents properly.

Avoid Heating Near Pressurized Lines

- Avoid torching, welding, and soldering near pressurized hydraulic lines. Pressurized lines may accidentally burst when heat goes beyond the immediate flame area.



Safe Hydraulic Maintenance

- Always practice personal safety when performing service or maintenance on the hydraulic system.
- Use caution when working around hydraulic fluid under pressure. Escaping fluid can have sufficient force to penetrate your skin, causing serious injury. This fluid may also be hot enough to burn.

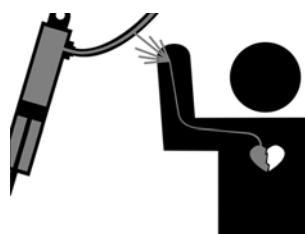

- Always lower the load or relieve pressure before repairing a hydraulic leak.

This safety feature introduces an electrical interlock that ensures that when the operator is out of the cab, the operation of these functions have stopped. This is achieved by using the OPS to prevent the detasseler assemblies from operating if the operator is not seated in the operator's seat for three (3) seconds.



Operator Presence Switch
(Located inside the operator's seat)
-Typical View

When the operator leaves the operator's seat while the machine is running, a warning message will appear on the Machine Display to alert the operator to operate the machine from seat. Press OK to acknowledge and depress the Main Control Switch (located on the Hydrostatic Drive Control Handle) to resume operation.

OPERATOR PRESENCE SWITCH (OPS)

The Operator Presence Switch (located inside the operator's seat) protects the operator from exposure to moving parts or hazards when operating the detasseler cutter heads and quad pullers.

Decal Locations

650178
(2) Quick-Tach

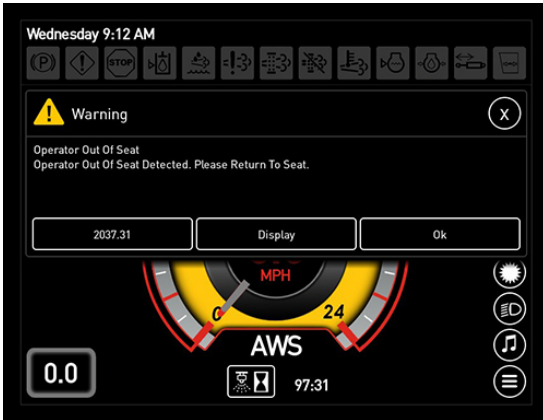

Operator Out Of Seat Message
(Located on the Machine Display)

SAFETY DECALS

Decals warning you of avoidable danger are located on various parts of the attachment and cab area. They are there for your personal safety and protection. DO NOT remove them. They will fracture upon attempted removal and therefore, must be replaced.

Following are locations of important safety decals. Replace them if they are damaged or missing. All safety decals, instructional decals, or machine striping may be purchased through your local John Deere dealer.

To replace safety decals, ensure the installation area is clean and dry and decide on exact position before you remove the backing paper.

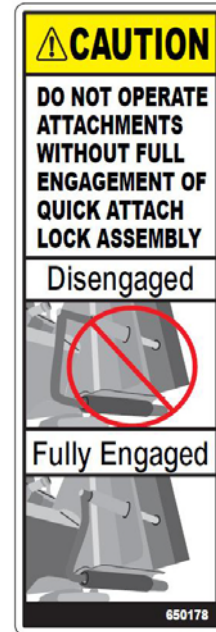

650218
(2) - One located on each end of combo attachment

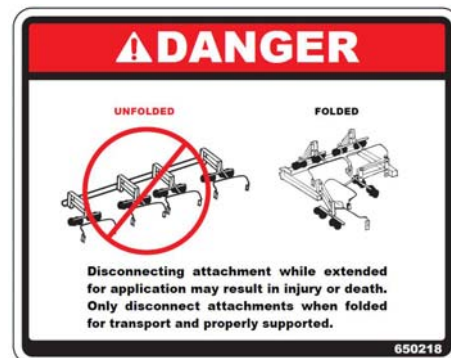

650258
(Located on each side of cutter head assemblies)



SEVERING OF FINGERS OR HAND.
DO NOT PLACE FINGERS OR
HAND NEAR A MOVING CUTTER BLADE,
ATTEMPT TO STOP A MOVING CUTTER
BLADE, OR PERFORM MAINTENANCE
NEAR A MOVING CUTTER BLADE.

650259
(Located on mounting tube of each
quad puller head assembly)



RISK OF INJURY FROM ROTATING TIRES.
DO NOT PLACE FINGERS OR HAND
NEAR MOVING QUAD PULLER TIRES,
DISLodge A WEDGED OBJECT FROM
MOVING TIRES, OR PERFORM
MAINTENANCE NEAR MOVING TIRES.

650303
(Located on right-hand cab window)

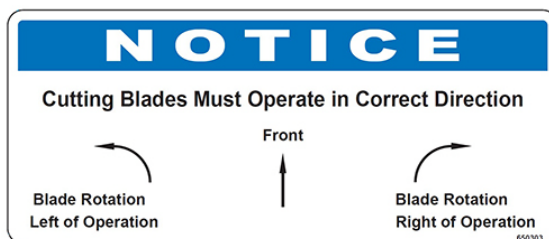

650339
(Located on left-hand front cross
member)



650379
(Located on right-hand cab window)

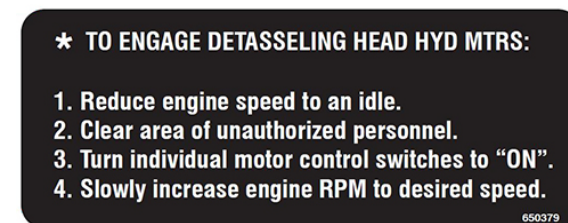



SECTION 3 – OPERATING YOUR DTB

DETASSELING SYSTEM COMPONENTS

The Detasseling System is a constantly monitored and continuously adjusted system. The cab-mounted control system receives data from the photo light sensors to determine detasseling height.

The following information in this section explains the detasseling components and their operation. Read the following section entirely before operating the Detasseling System.

NOTICE

Attachment maintenance and repair, including clearing blockages/unplugging detasseler components should be performed by qualified service personnel only.

- (A) - Detasseler Tool Bar Attachment
- (B) - LS System 12™/Depth Command
- (C) - LS Photo Light Sensors
- (D) - Cutter Heads
- (E) - Quad Pullers
- (F) - Depth Control Switches
- (G) - Outrigger Fold Switches (Left/Right)
- (H) - Motor Control Switches
- (I) - Tasselrol®/LS System 12 Control Panel
- (J) - All-Up/Down Switches (2)
- (K) - Main Control Switch

A

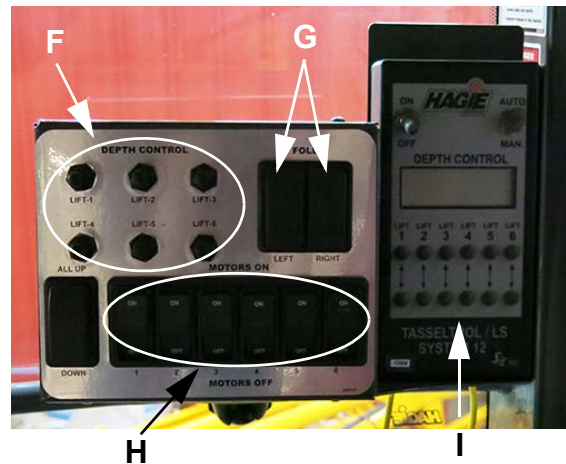
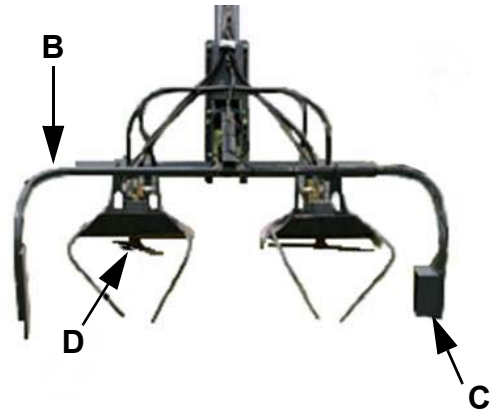



DTB Attachment
(Shown with quad pullers)
-Typical View

LS System 12/Depth Command

The LS System 12/Depth Command is an automatic height adjustment system controlled by the Tasselrol/LS System 12 Control Panel.



LS System 12/Depth Command
-Typical View

Detasseler Tool Bar Attachment (DTB)

The DTB attachment paired with the STS provides a high-clearance design along with adjustable automatic height control to perform timely detasseling of corn crops when timing is critical. The DTB unites functionality with customizable options to provide a solution that suits the individual needs of your operation.

LS Photo Light Sensors

The LS Photo Light Sensors detect crop height and send a signal to the LS System 12/Depth Command, which controls automatic height adjustment.



LS Photo Light Sensor Assembly
-Typical View

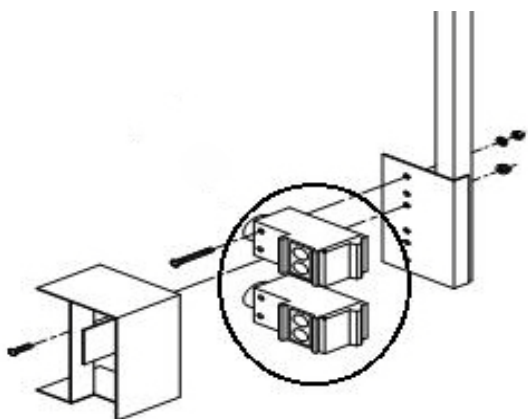

LS Photo Lights (Upper/Lower)
-Typical View

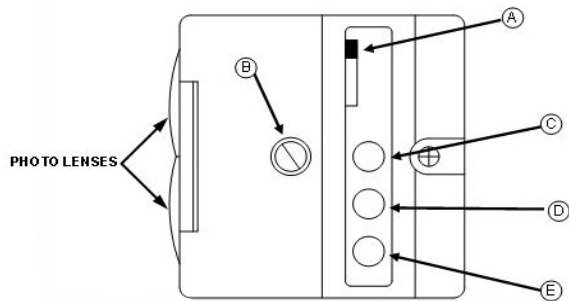

-Typical View

- The upper and lower LS Photo Lights are equipped with LED lights (A, C, D, E) that indicate operation status.
- The LT/DK (Light/Dark) Switch (A) (located on the photo light sensor) changes the activated condition of the green LED from ON (LT) to OFF (DK).

- The Sensitivity Adjustment Screw (B) should always be set to MAXIMUM.
- The Yellow LED Light (C) indicates the power is ON.
- The Green LED Light (D) indicates output energized (sending a signal to the Tasselrol Control Panel).
- The Red LED Light (E) indicates that the photo light is receiving reflected signal.

Cutter Heads

⚠ CAUTION



SEVERING OF FINGERS OR HAND.
DO NOT PLACE FINGERS OR HAND NEAR A MOVING CUTTER BLADE, ATTEMPT TO STOP A MOVING CUTTER BLADE, OR PERFORM MAINTENANCE NEAR A MOVING CUTTER BLADE.

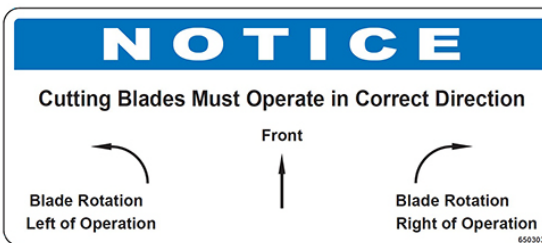

The hydraulically-driven Cutter Heads go through rows of corn and cut the tassels from the top of corn plants.

NOTE: Maximum operating speed = 3100 RPM.

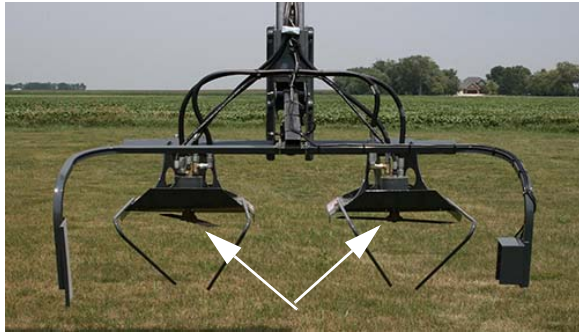

Cutter Heads
-Typical View



Quad Pullers
-Typical View

Quad Pullers

⚠ CAUTION



RISK OF INJURY FROM ROTATING TIRES. DO NOT PLACE FINGERS OR HAND NEAR MOVING QUAD PULLER TIRES, DISLodge A WEDGED OBJECT FROM MOVING TIRES, OR PERFORM MAINTENANCE NEAR MOVING TIRES.

NOTICE

Ensure quad puller tires have equal pressure. Check tire pressure daily.

NOTE: Maximum tire pressure = 10 psi (.7 bar).

The hydraulically-driven Quad Pullers go through rows of corn and pull the tassels from the top of corn plants by catching it between the Quad Puller tires moving at high speed in opposite directions.

NOTE: Maximum operating speed = 400 RPM.

Depth Control Switches

The Depth Control Switches (located on the detasseling control panel) allow the operator to adjust the LS System cutting or pulling height from inside the cab.



Depth Control Switches
(Located on the detasseling control panel)
-Typical View

Outrigger Fold Switches

(Left/Right)

The hydraulic Outrigger Fold Switches (located on the detasseling control panel) are used to hydraulically unfold/fold the outriggers.



Outrigger Fold Switches - Left/Right
(Located on the detasseling control panel)
-Typical View



Tasseltrol/LS System 12 Control Panel
-Typical View

Motor Control Switches

The Motor Control Switches (located on the detasseling control panel) activate the detasseling head motors individually.



Motor Control Switches
(Located on the detasseling control panel)
-Typical View

All-Up/Down Switches (2)

The All-Up/Down Switches (located on the detasseling control panel and the hydrostatic drive control handle) are used to raise or lower all row units at the same time.



All-Up/Down Switch
(Located on the detasseling control panel)
-Typical View

Tasseltrol/LS System 12 Control Panel

The Tasseltrol/LS System 12 Control Panel is used for programming the detasseling heads. The control panel can also be used to manually control the detasseling heads.



All-Up/Down Switch
(Located on the Hydrostatic
Drive Control Handle)
-Typical View



Main Control Switch
(Located on the Hydrostatic
Drive Control Handle)
-Typical View

Main Control Switch

The detasseling head motors are controlled by the Main Control Switch (located on the Hydrostatic Drive Control Handle). This switch must be in the ON position to enable detasseling head operation.

FOLD PROCEDURE - DETASSELER TOOL BAR



WARNING

Before proceeding, check area around the machine for bystanders, overhead objects, and power lines. Failure to comply may result in serious injury or death.

Unfolding the Attachment

(From storage position)

1. Ensure the Hydrostatic Drive Control Handle is in the NEUTRAL position.



Hydrostatic Drive Control Handle
-Typical View

2. Engage the parking brake.
3. Start the engine.
4. Press the Field/Road Button (located on the Machine Display Home Page) and change the machine's drive state to FIELD.

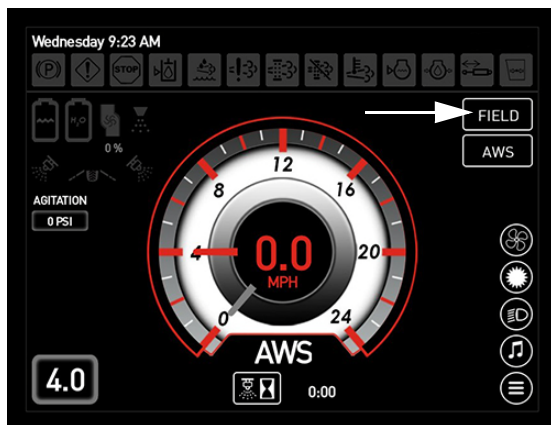

Field/Road Button
(Located on the Machine Display Home Page - Road and Field Mode)

5. Press and hold the corresponding Out-rigger Fold Switch (located on the detasseling control panel) in the DOWN (Unfold) position until outriggers fully extend.



Outrigger Fold Switches - Left/Right
(Located on the detasseling control panel)
-Typical View

6. **If equipped**, extend the outer sections of the 4-2 Detasseler Tool Bar OUT. Refer to “4-2 Detasseler Combo Attachment - Adjustable” provided elsewhere in this section for further information.



4-2 Detasseler Tool Bar - *if equipped*
(Extended View)

Folding the Attachment (To storage position)

NOTICE

4-2 Detasseler Tool Bar Only
Ensure the outer sections are fully retracted before folding the outriggers in. Failure to comply will result in property damage.

NOTICE

Stagger detasseling heads before folding the outriggers. Failure to comply will result in property damage. Refer to “Transporting” in the *Miscellaneous Section* elsewhere in this manual for further information.

1. **If equipped**, retract the outer sections of the 4-2 Detasseler Tool Bar IN. Refer to “4-2 Detasseler Combo Attachment - Adjustable” provided elsewhere in this section for further information.



4-2 Detasseler Tool Bar - *if equipped*
(Retracted View)

2. Press and hold the corresponding Outrigger Fold Switch (located on the detasseling control panel) in the UP (Fold) position until the outriggers fully retract.



Outrigger Fold Switches - Left/Right
(Located on the detasseling control panel)
-Typical View

DETASSELING SYSTEM - OPERATION

Operating Instructions

1. Program the Tasselrol®/LS System 12™ Control Panel.

NOTE: Refer to the manufacturer’s operation manual for programming instructions.



Tasselrol/LS System 12 Control Panel
-Typical View

2. Test the Photo Light Sensors.

Auto Mode:

- Cover top photo lens and lift should move UP.
- Do not cover any of the lenses and lift should move DOWN.
- Cover bottom photo lens and lift should stay in position.

Manual Mode (Machine Off):

- When red LED is uncovered, LED should be ON.
- When red LED is covered, LED should be OFF.



Photo Light Sensor
-Typical View



Motor Control Switches
(Located on the detasseling control panel)
-Typical View

3. Engage the parking brake.
4. Start the engine.
5. Press the Field/Road Button (located on the Machine Display Home Page) and change the machine's drive state to FIELD.

NOTE: Selected drive state will illuminate.

7. Press the Main Control Switch (located on the Hydrostatic Drive Control Handle) to the ON position.

NOTICE

If loss of hydraulic pressure occurs or the low hydraulic oil warning indicator appears on the Machine Display, shut down the system immediately. Failure to comply may result in system damage and will void the warranty.

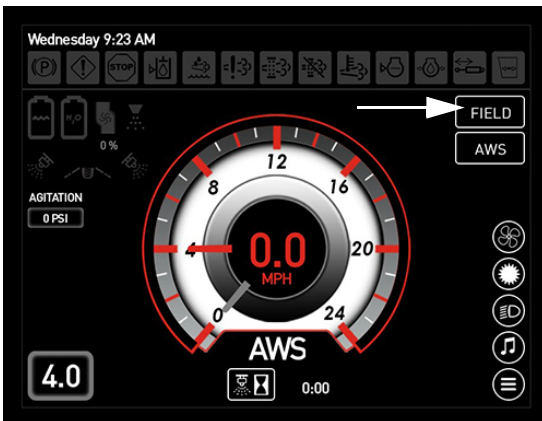

Field/Road Button
(Located on the Machine Display Home Page - Road and Field Mode)

6. Press the corresponding Motor Control Switches (located on the detasseling control panel) in the UP position to turn desired detasseling head motors ON.



Main Control Switch
(Located on the Hydrostatic
Drive Control Handle)
-Typical View

8. Press and hold the Throttle Switch (located near the Hydrostatic Drive Control Handle) in the UP/“rabbit icon” position to achieve the recommended RPM to operate the detasseling head motors.

NOTE: Detasseling heads will be available for immediate use by increasing engine RPM.

NOTICE

Operating the Detasseling System below the recommended 2300 engine RPM will not provide the system with adequate hydraulic oil flow and may cause degraded or poor performance.



Throttle Switch
(Located near the Hydrostatic
Drive Control Handle)
-Typical View

4-2 DETASSELER ATTACHMENT - ADJUSTABLE

-If Equipped



4-2 Detasseler Combo Attachment
(Retracted View)



• RH Slide
Extension

• LH Slide
Extension

4-2 Detasseler Combo Attachment
(Extended View)

Unfolding the Attachment

1. Press and hold the corresponding Out-rigger Fold Switch (located on the detasseling control panel) in the DOWN (Unfold) position until outriggers fully extend.
2. Continue to press and hold switch to extend the left and right-hand Slide Extensions.



Outrigger Fold Switches - Left/Right
(Located on the detasseling control panel)
-Typical View

NOTE: If the left or right-hand Slide Extensions extend before the outriggers are unfolded, adjust Sequence Valves SE1 (left) and/or SE3 (right) (located on the Valve Block) by turning the corresponding Adjustment Screw(s) in the “clockwise” position to allow the outriggers to unfold first.
If the left or right-hand Slide Extensions do not extend after the outriggers have been unfolded, adjust Sequence Valves SE1 (left) and/or SE3 (right) by turning the corresponding Adjustment Screw(s) in the “counter-clockwise” position to allow the Slide Extensions to extend.

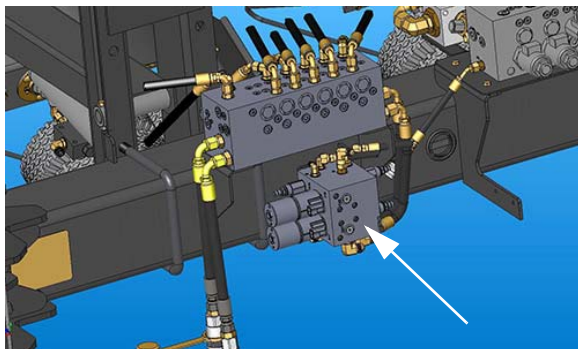

Valve Block
(Located on the front side of attachment)
-Typical View

To Adjust Sequence Valves:

NOTE: Sequence Valves are labeled on the Valve Block.

- Using a 9/16” wrench, loosen Lock Nut(s).
- Using a 5/32” hex wrench, turn Adjustment Screw(s) in the desired position.
- Re-tighten Lock Nut(s) to 7 ft.-lbs.

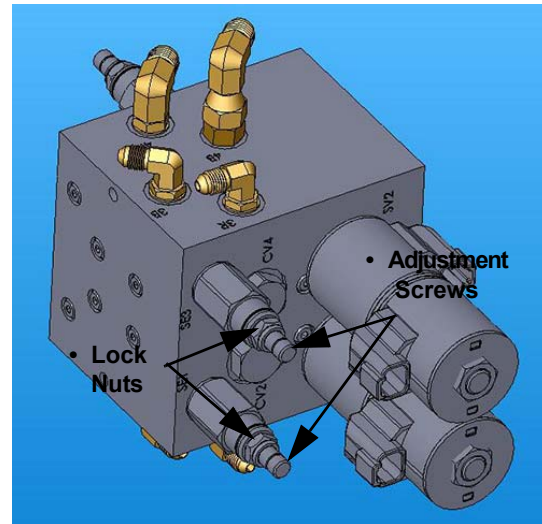

Lock Nuts/Adjustment Screws
(Located on the Valve Block)
-Typical View

Folding the Attachment

NOTICE

Ensure slide extensions are fully retracted before folding the outriggers in. Failure to comply will result in property damage.

NOTICE

Stagger detasseling heads before folding the outriggers. Failure to comply will result in property damage. Refer to “Transporting” in the *Miscellaneous Section* elsewhere in this manual for further information.

1. Press and hold the corresponding Out-rigger Fold Switch (located on the detasseling control panel) in the UP (Fold) position until the Slide Extensions fully retract.
2. Continue to press switch until the outriggers fold in completely.



Outrigger Fold Switches - Left/Right
(Located on the detasseling control panel)
-Typical View

NOTE: If the outriggers fold in before the **Slide Extensions retract**, adjust Sequence Valves SE2 (left) and/or SE4 (right) (located on the Valve Block) by turning the corresponding Adjustment Screw(s) in the “clockwise” position to allow the Slide Extensions to retract first.

If the outriggers do not fold in after the Slide Extensions have been retracted, adjust Sequence Valves SE2 (left) and/or SE4 (right) by turning the corresponding Adjustment Screw(s) in the “counter-clockwise” position to allow the outriggers to fold in.

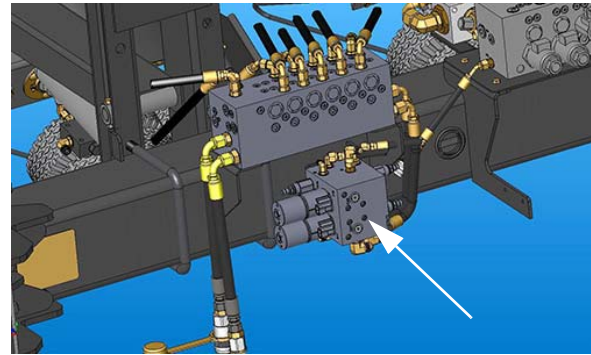

Valve Block
(Located on the front side of attachment)
-Typical View

To Adjust Sequence Valves:

NOTE: Sequence Valves are labeled on the Valve Block.

- Using a 9/16” wrench, loosen Lock Nut(s).
- Using a 5/32” hex wrench, turn Adjustment Screw(s) in the desired position.
- Re-tighten Lock Nut(s) to 7 ft.-lbs.

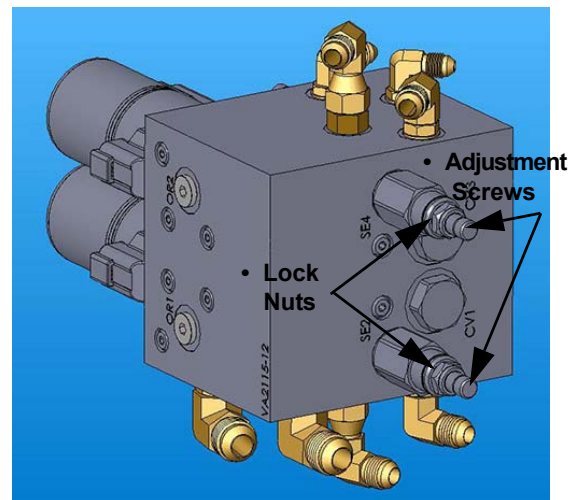

Lock Nuts/Adjustment Screws
(Located on the Valve Block)
-Typical View

TASSELTROL®/LS SYSTEM 12™

Setting Up

Enter Parameter Mode

- Press the Auto/Manual Switch (located on the Tasseltrrol/LS System 12 Control Panel) in the UP (Auto) position.



Auto/Manual Switch
(Located on the Tasseltrrol/
LS System 12 Control Panel)
-Typical View

- Press the On/Off Switch (located on the Tasseltrrol/LS System 12 Control Panel) in the UP (On) position.
- On the LCD display will be four lines. The top line displays the program level. The second line will flash “Select Manual” (as a warning that you are about to enter the parameter adjustment mode). Current parameter settings are displayed on the bottom line (values for B, R, T, L, and D are typically set). The machine type will vary from x, o, p, or c, depending on the valve system.

NOTE: “L” may vary, depending on the number of lifts on the machine.

```
S. I. E.      level C9.02
SELECT MANUAL
CABLE BOX sn: C98009
PAR=c B1 R2 T3 L6 D00
```

NOTICE

Machines with Tasseltrrol software version 8.7 and greater have an enhancement that allows the operator to set the lift speeds for auto mode functions.

Match the Machine Valve Type

NOTICE

Ensure the machine valve type is selected correctly to match the machine in which the Tasseltrrol/LS System 12 Control Panel is installed on.

- Press the LIFT 1 UP Switch (located on the Tasseltrrol/LS System 12 Control Panel) **two times** to display the machine type selected.

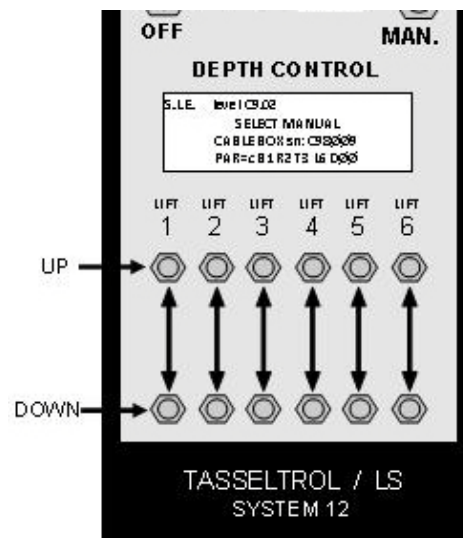

- The x, o, p, or c (located to the right of “NEXT” on the bottom line of the LCD display) indicates the type of machine. Press the LIFT 2 UP Switch. The display will now change to the “Select Machine Type” screen.

```

o= original valves
p= proportional
c= combo    x= 204XP
NEXT  x    o    p    c
    
```

- Select the type of machine that the unit is installed on.

NOTE: For machines built prior to 2007 with the original valve system, press the LIFT 4 Switch under the “o”. If the machine is equipped with proportional valves, press the LIFT 5 Switch under the “p”.

For machines built 2007 or newer with proportional valves, press the LIFT 6 Switch under the “c”.

- The display will now revert back to the “Select Manual” screen with the machine type that you have just selected displayed on the bottom line.

Match How Many Lifts are on the Machine

(System must be in parameter mode before proceeding)

- Press the LIFT 1 UP Switch **two times** to display how many lifts are on.

NOTE: “L6” on the display indicates that all six lifts are ON. This should always be set to L6.

```

PRESS UP TO CHANGE
PARAMETERS
PRESS DOWN TO QUIT
NEXT c L6 D00 V1
    
```

- To change the number of lifts to match your machine, press the LIFT 3 UP Switch. This will display the LIFTS: ON-OFF screen.

```

LIFTS: ON _ OFF
1 2 3 4 of 6
    
```

- Press the LIFT UP Switch under the corresponding lift that you want to turn on/off.
- After selecting which lifts are to be on/off, press the LIFT 1 DOWN Switch **two times** to exit the screen and save new parameter setting.

Your machine is equipped with six (6) hydraulic lift hoses, regardless of the number of lifts available. For machines with less than six lifts, unused lift hydraulics will be capped off. When matching how many lifts are on your machine, program the correct number of lifts into the display to ensure maximum performance.

```

LIFTS: ON _ OFF
of 2 3 4 5 of
    
```

4-Lift Machine

```

LIFTS: ON _ OFF
of 2 3 4 of of
    
```

3-Lift Machine

```

LIFTS: ON _ OFF
of of 3 4 of of
    
```

2-Lift Machine

Establish “D” and “V”

(System must be in parameter mode before proceeding)

- Press the LIFT 1 UP Switch **two times** and the display will show the current set-

ting of **Dwell** (A) for “all up” and **Valve Compensation** (B) as either 1=ON, or 0=OFF.

```

PRESS UP TO CHANGE
PARAMETERS
PRESS DOWN TO QUIT
NEXT c L6 D00 V1
    
```

(A)
(B)

- The “D” value indicates how many seconds that the lifts will travel up after the All Up Switch (located on the Hydrostatic Drive Control Handle or the Detasseling Control Panel) is pressed momentarily. This time can be changed by pressing the LIFT 4 UP Switch.

NOTE: The time is factory preset to 0, but can be set to a value of 25 while adjusting the machine valves.

- Pressing the LIFT 4 UP Switch will add five (5) seconds to the value each time until “D25”, then will return to “D00”. When the value is set to D00, the up motion stops as soon as the All Up Switch is released. If the value is set to anything greater than D00, the All Up Switch will only need to be pressed momentarily and the lifts will continue the up move until the parameter has been reached.
- The “V” value indicates whether or not the valve automatic compensation is performed. Press the LIFT 6 UP Switch to change this value.

NOTE: This value is typically left at “V1”.

Set the Lift Up Speeds

(System must be in parameter mode before proceeding)

- Press the LIFT 1 UP Switch **three times** and the display will show the current setting of the Up Speed for an auto, manual, and all-up move with a value from 01 to 10.
- With the value set to 01 in “MAN” or to 03 in “AUTO” and “ALL”, the lifts will move slow enough to see if any are moving slower than the rest. These settings

are useful for adjusting the offset of the values to get all the lifts to move at the same speed. Typically, these values are set to 05 for a fairly fast speed. The values can be changed by pressing the Up/Down Switches under AUTO, MAN, or ALL.

```

Up Speed:
                AUTO MAN ALL
<typical 05>
NEXT           05  05  05
    
```

↑
↑
↑

NOTE: Values can be saved by pressing the LIFT 1 DOWN Switch to exit screen and save the new parameter setting.

Set the Lift Up Offset

(System must be in parameter mode before proceeding)

- Press the LIFT 1 UP Switch **four times** and the display will show the current setting of the Up Offset for the first three lifts. Pressing NEXT again will show the offset setting for the last three lifts. The Up Offset for each valve can be set from -19 to +20, as needed to get the lift speed to match the speed of the other lifts.

NOTE: The more positive the number, the faster the lift will move. Typically, the offset is initially adjusted at a very slow speed by setting the Lift Up Speed to either 01 or 03.

```

Up Speed:
                AUTO MAN ALL
<typical 05>
NEXT           03  01  03
    
```

```

Up Offset:
                1    2    3
<typical 00>
NEXT          +01 -06  00
    
```

- Exit parameter mode and check the speed of each lift by moving it manually with the Up/Down Switches.
- Correct the fastest and slowest lifts to match the average speed by changing the offset value with the Up/Down Switches for that lift while in the Lift Up Offset parameter.
- When finished setting the offset values, return the speed setting back to approximately 05.

```
Up Offset:
                4    5    6
<typical 00>
NEXT      -07 +05  00
```

- With all the lifts at their lowest points, select AUTO.
- Press the All Up Switch (located on the Hydrostatic Drive Control Handle or the Detasseling Control Panel) so the lifts all move up at the same time. Correct the values for any lifts that are not close to the speed of the others.

NOTE: Values can be saved by pressing the LIFT 1 DOWN Switch to exit the screen and save the new parameter setting.

NOTICE

To get all the lift speeds even, you may need to lower the speed below 05. This will ensure that the flow is being controlled by the value rather than restricted by the .042" (.1 cm) orifice. After adjusting the offset parameters for even up speeds, the up speed value can be increased back to 05.

- With the value set to 03, the lifts will move a little slower. This setting of 03 is useful when adjusting the offset of the values for getting all the lifts the same speed. Typically, these values are set to 05 for a fairly fast speed. The values can be changed by pressing the Up/Down Switches under the AUTO, MAN, or ALL.

NOTE: Values can be saved by pressing the LIFT 1 DOWN Switch to exit the screen and save the new parameter setting.

```
Down Speed:
                AUTO  MAN  ALL
<typical 05>
NEXT           05   05   05
```

Set the Lift Down Offset

(System must be in parameter mode before proceeding)

- Press the LIFT 1 UP Switch **seven times** to display the current setting of the Down Offset for the first three lifts.
- The Down Offset can be adjusted for a value from -19 to +20.

NOTE: The more positive the number, the faster the lift will move. Typically, the offset is initially adjusted at a slower speed by setting the Lift Down Speed to 03.

Set the Lift Down Speeds

(System must be in parameter mode before proceeding)

- Press the LIFT 1 UP Switch **six times** and the display will show the current setting of the down speed for an auto, man-

```

Down Speed:
          AUTO MAN ALL
<typical 05>
NEXT      03  03  03
    
```

```

Down Offset:
          1    2    3
<typical 00>
NEXT     +01 -06  00
    
```

- Exit parameter mode and check the speed of each lift by moving it manually with the Up/Down Switches.
- Correct the fastest and slowest lifts to match the average speed by changing the offset value with the Up/Down Switches for that lift while in the Down Offset parameter.
- When finished setting the offset values, return the speed setting back to approximately 05.
- With all lifts at their highest points, select AUTO so all lifts move down together. Correct the values for any lifts that are not close to the speed of the others.

NOTE: Values can be saved by pressing the LIFT 1 DOWN Switch to exit the screen and save the parameter setting.

```

Down Offset:
          4    5    6
<typical 00>
NEXT     -07 +05  00
    
```

Once you have set the operating parameters, you can adjust the Response Parameters. These parameters are used to adjust the response of the controller and seldom need changing. The parameter values are stored in flash memory and will be retained even when no battery power is present.

NOTICE

Once parameters have been set, minimal adjustment is required.

The programmable control panel is factory preset with the following parameter defaults:

- **Response Parameter (R2)**
- **Top Parameter (T3)**
- **Bottom Parameter (B1)**

These parameters will always be displayed until the control panel is reprogrammed. Once reprogrammed, the new values for the parameters will be displayed on the control panel.



To program the unit, first select the Response Parameter. If further adjustment is required for top and/or bottom parameters, continue with their adjustments.

Tasselrol Response Parameter

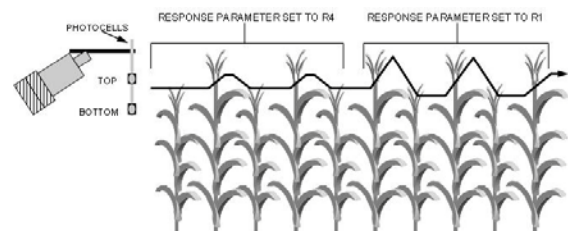

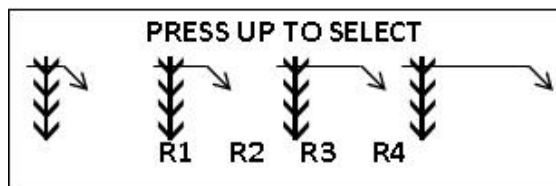

The Response Parameter is used to adjust the response time of both photocells - how quickly the down motion starts when no corn is detected by either top or bottom cells, and how quickly the up motion is stopped when corn is no longer detected by the top cell. This can be changed by selecting R1, R2, R3, or R4.

NOTE: More corrections will occur when R1 is selected and fewer with R4 selected. The normal (default) value for this parameter is R2, but can be set to any desired value.

Use the Response Parameter to adjust overall correction activity and to compensate for ground speed. If the quad pullers are moving too quickly and frequently, the Response Parameter can be increased toward R4. If the quad pullers are too slow to respond to changes in the corn depth, decrease the parameters toward R1. Generally, this parameter can be left at R2.

To display the Response Parameter:

- Press the Auto/Manual Switch (located on the Tasselrol/LS System 12 Control Panel) in the UP (Auto) position.
- Press the On/Off Switch (located on the Tasselrol/LS System 12 Control Panel) in the UP (On) position. Wait approximately three (3) seconds for the “Select Manual” message to appear.
- Press the LIFT UP Switch under “PAR”.
- Press the LIFT UP Switch under the “R” value.

The active value of the parameter is indicated by it blinking on and off while the other three options are displayed continuously.

To select a new value for the parameter:

- Press the LIFT UP Switch under the desired selection.

- After selecting one of the four options, press the LIFT 1 DOWN Switch to escape this parameter.
- To save new values and escape the parameter mode, press the LIFT 1 DOWN Switch a second time.

Tasselrol Top Parameter

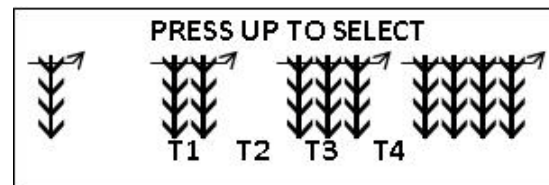
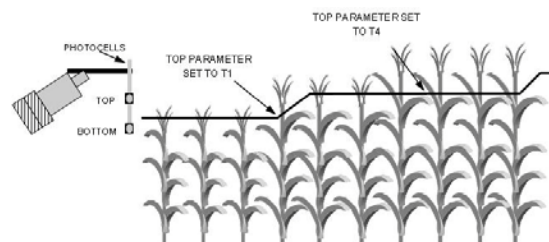

The Top Parameter is used to adjust the sensitivity time of the top photocell. The top photocell starts the up motion when its light path is blocked by corn. How much corn it has to see before starting the up move can be changed by selecting one of the four values: T1, T2, T3, or T4.

NOTE: When T1 selected, less corn is required to start an up move. The normal (default) value for this parameter is T3, but can be set to any desired value.

If the quad pullers move up too easily when a taller stalk of corn passes, increase the parameter toward T4. If the quad pullers stay deep too long when taller corn passes, decrease the parameter toward T1. Generally, this parameter can be left at T3.

To display the Top Parameter:

- Press the Auto/Manual Switch (located on the Tasselrol/LS System 12 Control Panel) in the UP (Auto) position.
- Press the On/Off Switch (located on the Tasselrol/LS System 12 Control Panel) in the UP (On) position. Wait approximately three (3) seconds for the “Select Manual” message to appear.

- Press the LIFT UP Switch under “PAR”.
- Press the LIFT UP Switch under the “T” value.

The active value of the parameter is indicated by it blinking on and off while the other three options are displayed continuously.

To select a new value for the parameter:

- Press the LIFT UP Switch under the desired selection.
- After selecting one of the four options, press the LIFT 1 DOWN Switch to escape this parameter.
- To save new values and escape the parameter mode, press the LIFT 1 DOWN Switch a second time.

Tasseltrol Bottom Parameter

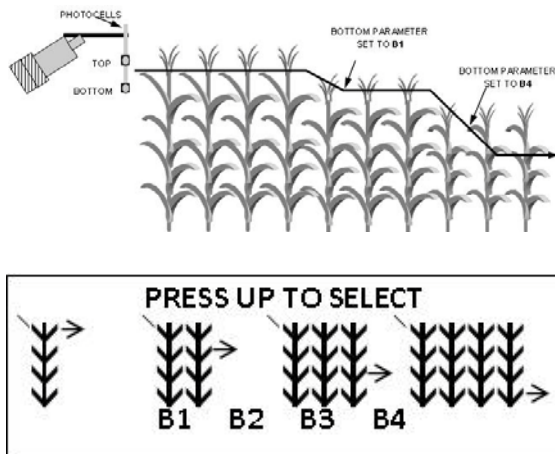

The Bottom Parameter is used to adjust the sensitivity time of the bottom photocell. The bottom photocell stops the down motion when it's light path is blocked by corn. Selecting one of the four values (B1, B2, B3, or B4) will set how much corn the photocell has to see before it stops moving down.

NOTE: When B1 is selected, the down move will stop as soon as corn is detected. The normal (default) value for this parameter is B1, but can be set to any desired value.

If the quad pullers run too shallow after moving down into shorter corn, increase the parameter toward B4. If the quad pullers move too deep when going into shorter corn or oscillates between the top and bottom

photocells, decrease the parameter toward B1. Generally, this parameter can be left at B1.

To display the Bottom Parameter:

- Press the Auto/Manual Switch (located on the Tasseltrol/LS System 12 Control Panel) in the UP (Auto) position.
- Press the On/Off Switch (located on the Tasseltrol/LS System 12 Control Panel) in the UP (On) position. Wait approximately three (3) seconds for the “Select Manual” message to appear.
- Press the LIFT UP Switch under “PAR”.
- Press the LIFT UP Switch under the “B” value.

The active value of the parameter is indicated by it blinking on and off while the other three options are displayed continuously.

To select a new value for the parameter:

- Press the LIFT UP Switch under the desired selection.
- After selecting one of the four options, press the LIFT 1 DOWN Switch to escape this parameter.
- To save new values and escape the parameter mode, press the LIFT 1 DOWN Switch a second time.

Operating the Control Panel with Normal Parameter Settings

- Engage the parking brake.
- Turn the ignition to the ON position.
- Press the On/Off Switch (located on the Tasseltrol/LS System 12 Control Panel) in the UP (On) position.
- Press the Auto/Manual Switch (located on the Tasseltrol/LS System 12 Control Panel) in the DOWN (Manual) position.

NOTE: At this time, the display will read “MANUAL” in addition to other information identifying the control panel.

- Press the individual row switches for up or down movement. An arrow on the display will indicate direction of each lift.

NOTE: “P” indicates pressure, UP is only available on “o-type” machines, and UP/DOWN are available on “p, c, and x-type” machines.

- If the Auto/Manual Switch is left in the AUTO position when the unit is first started, the display will tell you to “SELECT MANUAL”. After you have selected MANUAL, switch back to the AUTO position.
- To override the system, press the desired LIFT UP Switch to raise the attachment. When the switch is released, the system will revert back into AUTO mode.
- If the ignition is left on and the Auto/Manual Switch is left in AUTO position, the down coils on the electro-hydraulic valve will lose power after approximately 45 seconds. To reactivate, press the Auto/Manual Switch from AUTO to MANUAL, then back to AUTO.
- The control panel is set up with a feature that if a unit loses contact during operation in AUTO mode, the unit will automatically rise. If this should occur, switch to MANUAL mode and determine cause for the malfunction.

Short Corn Operation

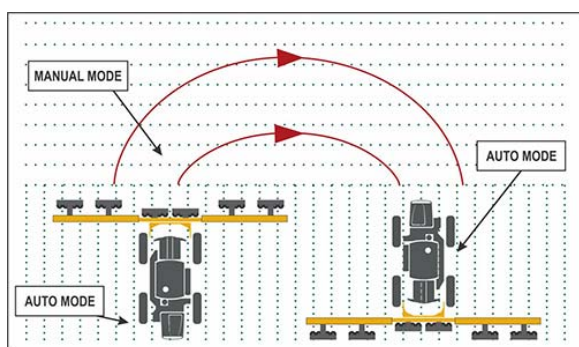

When operating the LS System, always select MANUAL when first entering the field. Once you have determined your operating speed and cutting/pulling depth, select AUTO. When you come to an area where the corn is very short, such as a low spot in the field, you may want to switch to the MANUAL position until you reach taller corn.

Always switch to the MANUAL position before you reach the end rows (see previous illustration). This will allow the cutter or puller heads to maintain their cutting or pulling height when re-entering the field. Then you may switch back to AUTO.

NOTE: You may choose to use the All Up/ Hold function instead of switching to manual. This function will raise all of the detasseling heads in one motion.

Operating

- Press the All-Up/Down Switch (located on the Hydrostatic Drive Control Handle or the Detasseling Control Panel) in the UP or DOWN position to raise or lower all row units.



All-Up/Down Switch
(Located on the Hydrostatic
Drive Control Handle)
-Typical View

To display the current supply voltage for the controller, press the All Up Switch while in MANUAL mode.



All-Up/Down Switch
(Located on the Detasseling Control Panel)
-Typical View

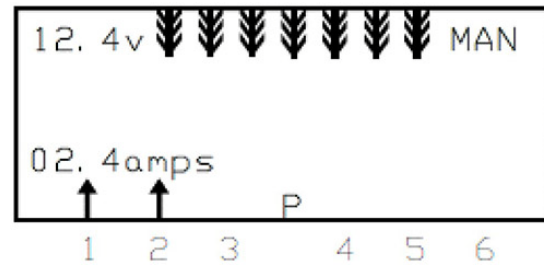

All row units will move up when the desired switch is pressed in the UP position and will lower when the switch is pressed in the DOWN position.

The parameters for Dwell on the up move can be set to 0, 5, 10, 15, 20, or 25 seconds. The heads will move up this amount of time without having to hold the All-Up/Down Switch in the up position (only in values greater than 0.) All heads will hold this position when the parameter is reached. To resume automatic depth control, press the All-Up/Down Switch in the DOWN position.

Additional Features

To temporarily lock a lift up, press and hold the LIFT UP Switch for the corresponding lift while switching from MANUAL to AUTO mode. The display will show “L” for that lift, which indicates that it is locked and will not move down automatically.

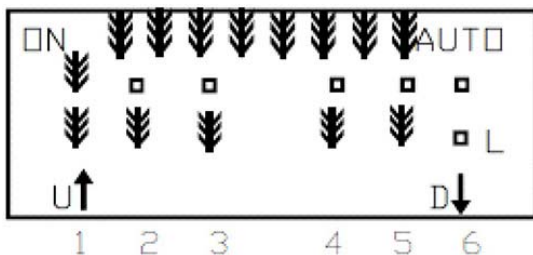

NOTE: The lift will return back to normal operation when MANUAL mode is again selected.

TASSELTROL FLOWCHART

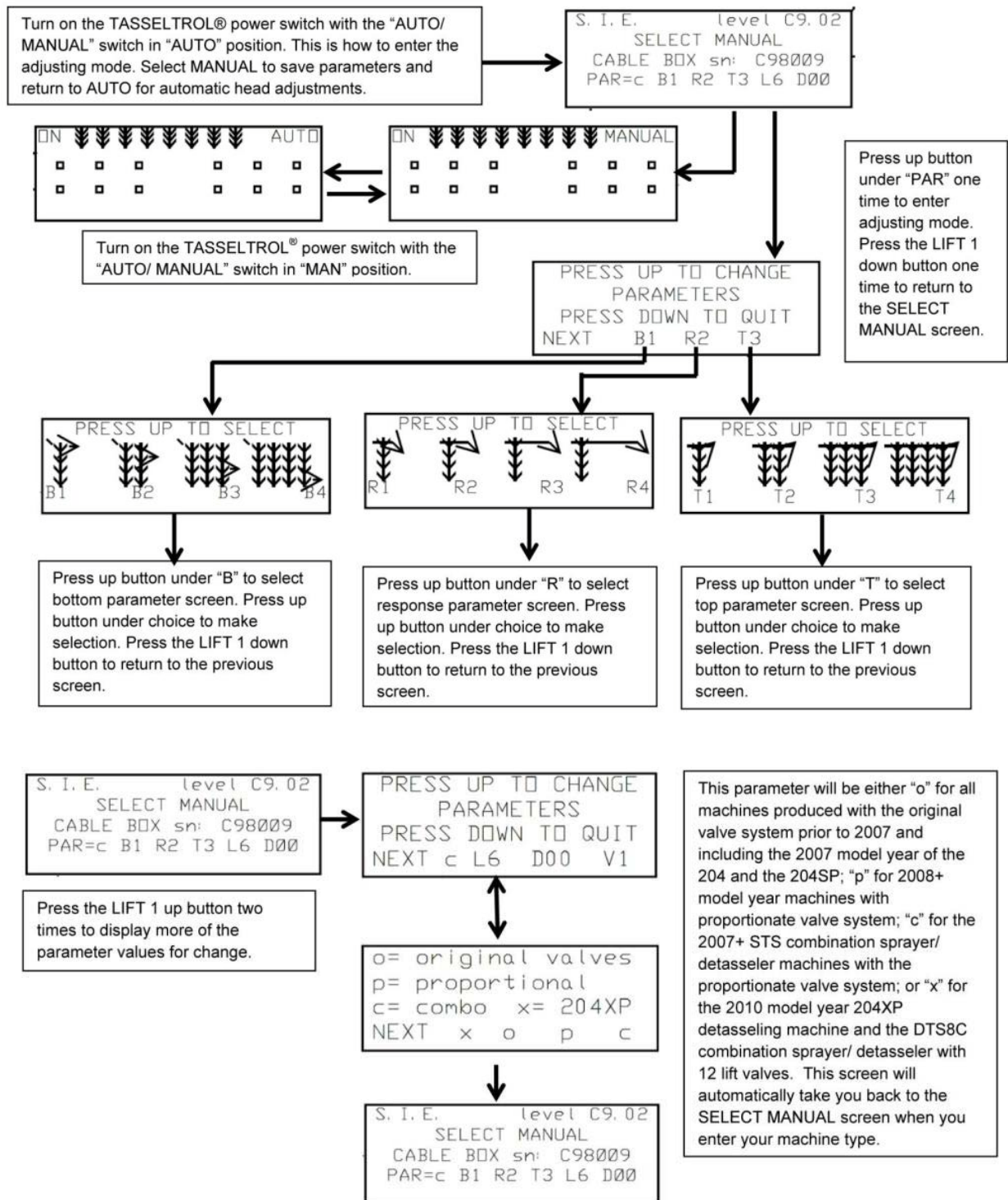

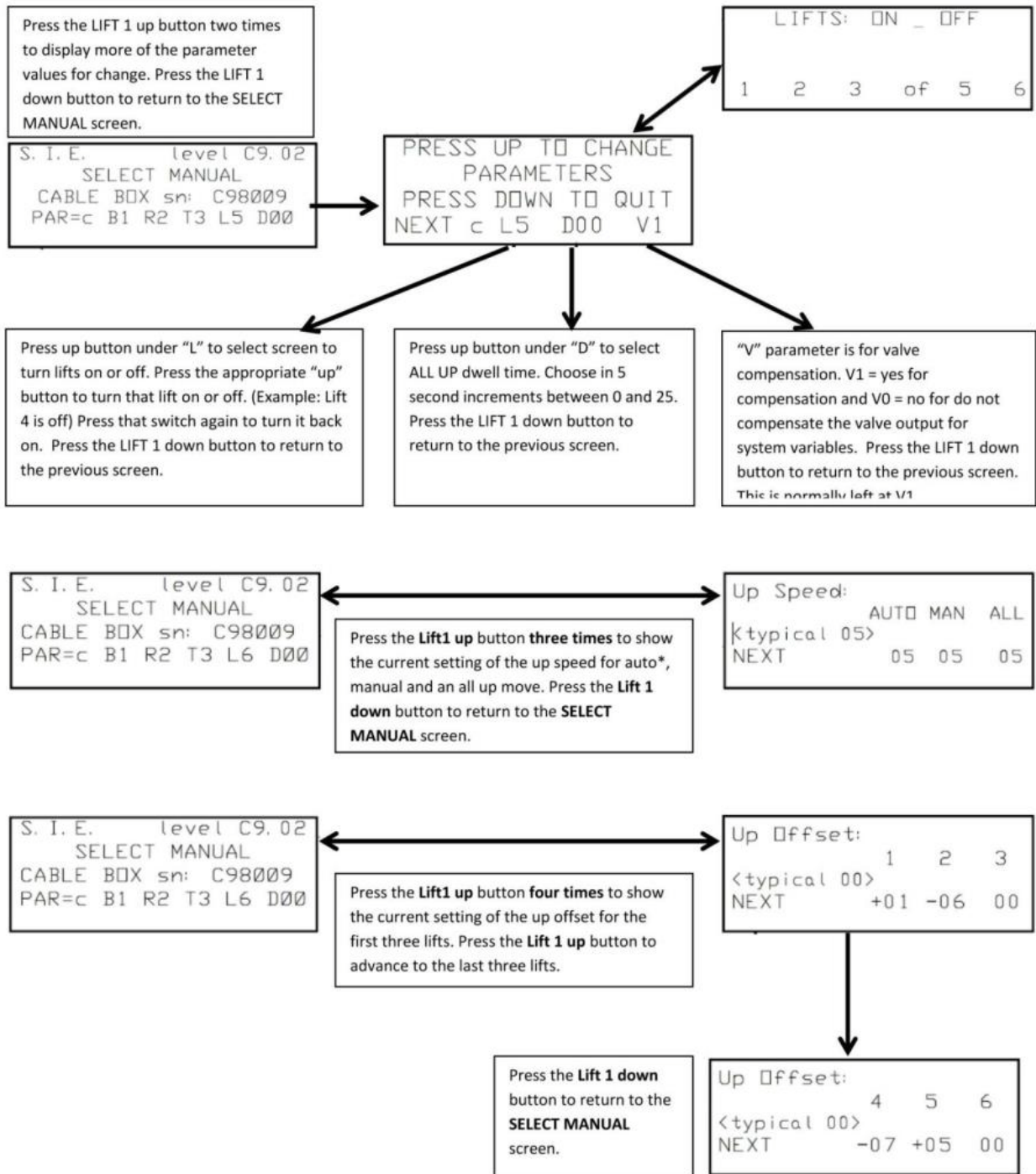

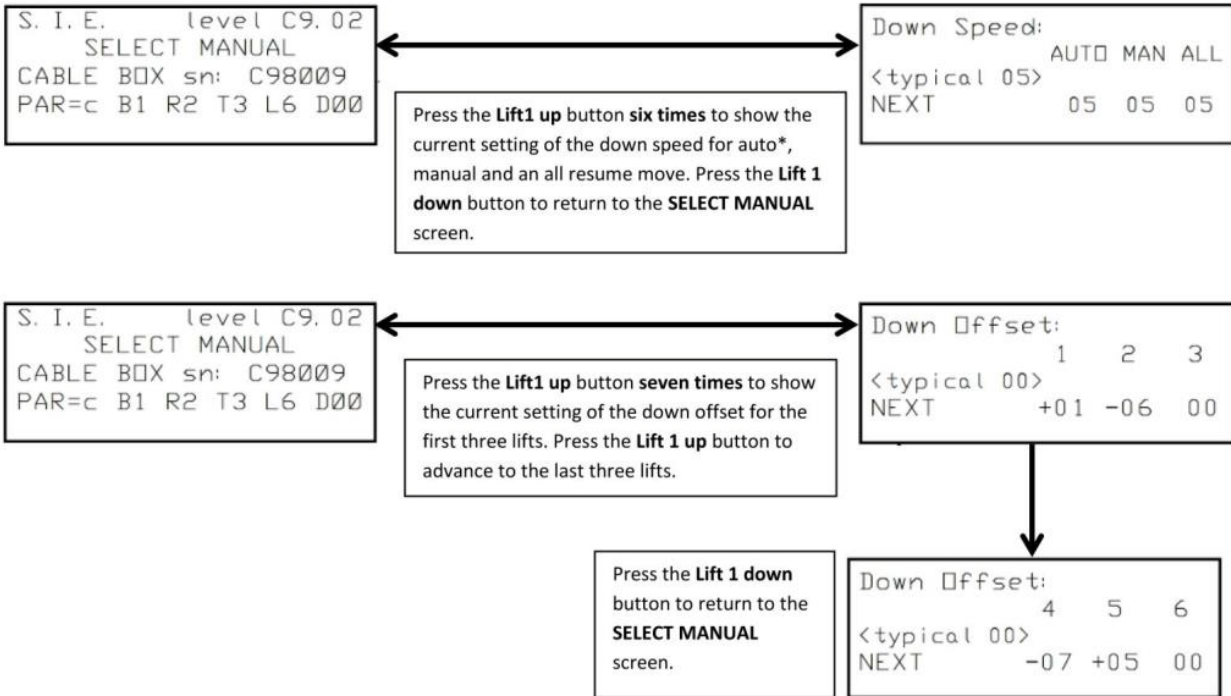

NOTE: With the exception of the machine type screen (which automatically reverts upon changing), you may advance through all the parameter settings while making changes without returning to the SELECT MANUAL screen each time by pressing the LIFT 1 UP Switch instead of the Down Switch. LIFT 1 DOWN saves the changes upon exiting the parameter screen.

KEY

- = reflector with no corn present
- ☙ = the photo cell is blocked by corn
- ↓ = the down valve is on
- ↑ = the up valve is on

P = the pressure valve is on. Displayed in the lower middle part of the screen.

LV = the source of voltage fell below 10.8 vdc for a low voltage condition. Displayed in the upper left corner of the screen in place of "ON" when situation occurs.

SHORT = current exceeded 18 amps and outputs are turned off for a short time. Displayed in place of "ON" when situation occurs.

t = task not completed in the 30 seconds allowed, will resume on next task. Displayed in place of "ON" when situation occurs.

of = a lift is turned off by the parameter settings

L = the operator locked that lift up until manual is selected again. Displayed next to bottom photo cell icon for the valve that is locked.

ALL HOLD = the operator pressed the ALL-UP button on the hydrostatic handle. Displayed in the middle of the screen.

U, D, or B = either the up, down, or both manual buttons are pressed for that lift. Displayed next to the arrow for the lift being used.

The diagram shows a grid of indicators for 6 lifts. The top row shows 'ON' status for each lift. The middle row shows photo cell status (☙) for each lift. The bottom row shows manual button status (U, D, B) for each lift. A 'P' indicator is in the center, and 'AUTO' is in the top right corner.



SECTION 4 – MAINTENANCE AND STORAGE

SERVICE - LUBRICATION

NOTICE

Failure to properly lubricate pivot and friction points may result in unnecessary wear and damage.

Quad Puller Heads

- Lubricate each Quad Puller Head grease zerk (4 - two each side) twice per day (morning and noon suggested).



Quad Puller Head
-Typical View

Outrigger Fold (Left and Right)

- Lubricate each left and right Outrigger Fold grease zerk (2) a minimum of every 50 hours of operation, or as needed.

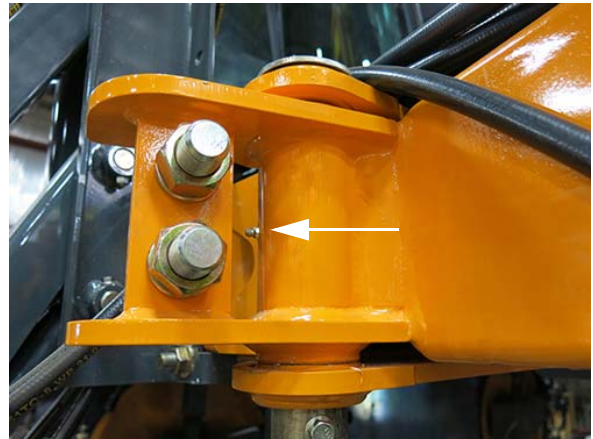

Outrigger Fold
-Typical View

Lift Arm Assemblies

- Lubricate each Lift Arm Assembly grease zerk (6) a minimum of every 50 hours of operation, or as needed.

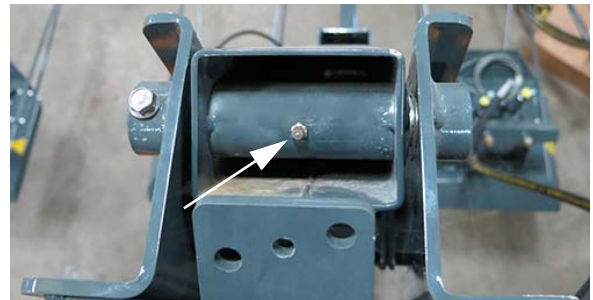

Lift Arm Assembly - Top
-Typical View



Lift Arm Assembly - Mid
-Typical View

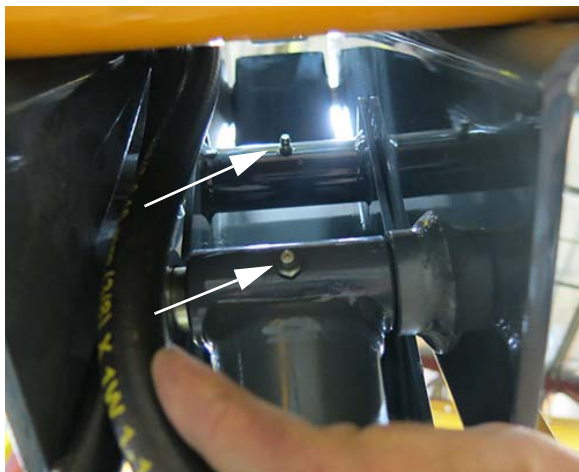

Lift Arm Assembly - Inner Arm
-Typical View

NOTE: An additional grease zerk is located inside of the lower lift arm frame.

SERVICE INTERVALS

Service Point	Daily/Before Each Use	50 Hrs.
Check Quad Puller Tire Pressure	X	
Check/Tighten Cutter Blade Retaining Bolts	X	
Lubricate Quad Puller Head Grease Zerks	X	
Lubricate Outrigger Fold Grease Zerks		X
Lubricate Lift Arm Assembly Grease Zerks		X

STORAGE

Preparing For Storage

1. Perform daily and weekly lubrication and maintenance inspections as required.
2. With the engine at normal operating temperature, cycle all the hydraulic functions.
3. Thoroughly wash the attachment and touch up any chipped or damaged paint.
4. Replace any damaged or missing decals.

NOTE: Contact your local John Deere dealer for paint touch-up recommendations and decal replacement.

5. Apply multi-purpose grease to hydraulic cylinder rods.
6. If the attachment will be stored separately, ensure that all electrical and hydraulic ends are capped or covered with a suitable covering.

Removal From Storage

NOTICE

Protective compounds such as grease can harden under exposure to weather conditions. Be sure to remove any dried grease and reapply new, if necessary.

1. Remove any dried grease from the cylinder rods and re-apply if necessary.
2. Thoroughly clean the attachment.
3. Carefully unseal any openings that were sealed for storage.
4. Attach DTB to the sprayer and manually cycle the hydraulics two or three times to adequately lubricate components.



SECTION 5 – MISCELLANEOUS

TRANSPORTING

Transporting Your Machine with an Attachment

WARNING

When transporting the machine, observe the following to avoid serious injury or death:

- Check for adequate clearance before driving under any overhead obstructions.
- Contact with power lines may result in serious injury or death.

CAUTION

Ensure there is adequate clearance when transporting the sprayer near an object with clearance less than the transporting height and width of the overall machine and attachment.

CAUTION

Avoid collisions. Before transporting machine on a public roadway, check and follow local regulations regarding size limits, the use of lights, flags, signs, pilot vehicles, and other requirements for transporting loads using trailer.

Folding the Outriggers

NOTE: If your combo attachment is equipped with the 4-2 feature, refer to “4-2 Detasseler Combo Attachment - Adjustable” provided elsewhere in this manual for information on folding and sequence valve adjustments.

NOTICE

Stagger detasseling heads before folding the outriggers. Failure to comply will result in property damage.

Before folding the outriggers, the detasseling heads must be staggered in height. Damage will occur if detasseling heads are all the same height when the outriggers are folded.

To Stagger the Detasseling Heads

- Using the corresponding Lift Up/Down Switches (located on the Tasselrol®/LS System 12™ Control Panel), stagger the detasseling heads.



Lift Up/Down Switches
(Located on the Tasselrol Control Panel)
-Typical View

1. Lower the two center detasseling heads all the way DOWN.
2. Raise all the detasseling heads on one side to approximately half of the fully raised height.
3. Raise the detasseling heads on the opposite side to the fully raised height.



Staggered Detasseling Heads
-Typical View

To Fold the Outriggers

- Slowly fold the outriggers in by pressing and holding the corresponding Outrigger Fold Switches (located on the detasseling control panel) in the UP (Fold) position, making adjustments (as necessary) to the height of the detasseling heads.



Outrigger Fold Switches - Left/Right
(Located on the detasseling control panel)
-Typical View

NOTICE

Do not attempt to make any adjustments to the detasseling heads after the outriggers are folded. Failure to comply may cause the stalk guides or depth command sensor bars to entangle, resulting in equipment damage.

Transporting Machine Using Trailer

Loading

! WARNING

Keep all persons away from trailer when loading or unloading the sprayer. Failure to comply may result in serious injury or death.

NOTICE

Read and understand the trailer manufacturer's operation manual. Hitch the trailer to the pulling vehicle according to their recommendations.

NOTICE

The loaded height and width of the trailer must conform to state law in which it is being used. Do not exceed the trailer manufacturer's recommendations on loaded weight.

1. Pull the trailer to flat ground.
2. Apply the pulling vehicle's parking brake and turn the engine OFF.
3. Use tire chocks to keep the trailer from moving.
4. Ensure the DTB outriggers are in the fully retracted (folded) position.
5. Lower the trailer ramps and set ramp spacing for the machine's tread width setting.
6. Have an attendant help guide you onto the trailer.
7. Allow enough room between the machine and the pulling vehicle for safe turning.
8. Secure the machine onto the trailer using the recommended securement

restraints (see trailer manufacturer's operation manual).

- Cover or remove the SMV (Slow Moving Vehicle) emblem when traveling over 25 mph (40 km/h).

Unloading

- Pull the trailer to flat ground.
- Apply the pulling vehicle's parking brake and turn the engine OFF.
- Use tire chocks to keep the trailer from moving.
- Lower the trailer ramps and set ramp spacing for the machine's tread width setting.
- Carefully release the securement restraints.
- Have an attendant help guide you off of the trailer.
- Uncover or replace the SMV (Slow Moving Vehicle) emblem.

Towing

NOTICE
Sprayer should never be towed under any circumstances. Machine damage will occur and will void the power train warranty.



Contact your local John Deere dealer if towing is unavoidable.

QUICK-TACH SYSTEM - DETASSELER TOOL BAR

⚠ WARNING
<p>When connecting or disconnecting the attachment, observe the following safety precautions:</p> <ul style="list-style-type: none"> • Monitor both sides of the attachment during fold procedure. • Select a safe area that is solid and level before unfolding/folding the attachment. • Clear area of personnel. • Check for overhead obstructions. • Do not unfold or fold combo attachment near power lines. Contact with power lines can result in serious injury or death.

⚠ WARNING
Turn the engine OFF before connecting/disconnecting any hoses or electrical lines. Failure to comply may result in serious injury or death.

Connecting the Detasseler Combo Attachment

- Square up to the combo attachment.
- Lower the machine by rotating the corresponding Air Suspension Valves (located on the left-hand front air bag) in the COUNTER-CLOCKWISE (Deflate) position.

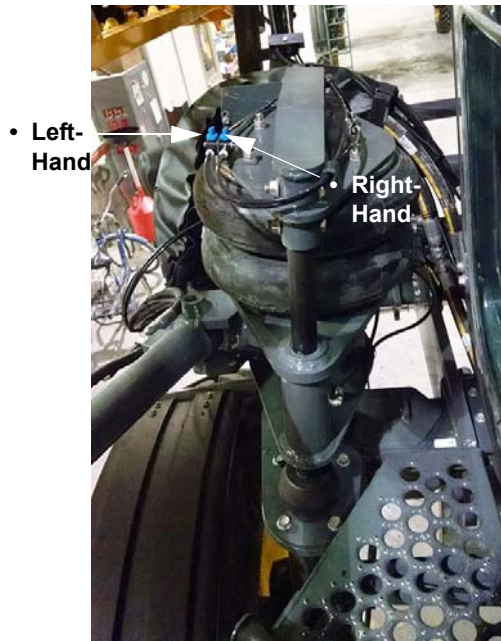

Air Suspension Valves
(Located on the left-hand front air bag)
-Typical View

3. Disengage the Quick-Tach Lock Assemblies by pulling the Lock Pins (located on the front left and right-hand side of machine) OUT as far as it will go until it is in the “lock-out” position.

NOTE: “Lock-out” position prevents re-locking while attaching or detaching the attachment.



Lock Pin (2)
(Located on the front left and
right-hand side of machine)
-Typical View
** Disengaged position shown*

4. Slowly pull into the combo attachment.
5. Ensure the Attachment Hooks are high enough to clear the Mounting Pins.



Attachment Clearing Mounting Pin
-Typical View

6. Raise the machine and engage Attachment Hooks by rotating the corresponding Air Suspension Valves in the CLOCKWISE (Inflate) position.

NOTE: Raising the machine will allow the weight of the attachment to pull the Attachment Hooks over the Mounting

Pins. You will notice a change of weight as the machine begins to support the attachment.

- Engage the Quick-Tach Lock Assemblies by pushing the Lock Pins IN, ensuring full engagement.

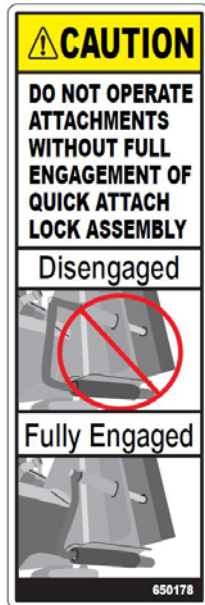

Lock Pin (2)
-Typical View

** Engaged position shown*

- Engage the parking brake.
- Turn the engine OFF before connecting any hoses or electrical lines!**
- Install the Hydraulic/Electric Connection (located on the left-hand side of combo attachment) into the Multi-Coupler Receptacle (located on left-hand side of machine), ensuring full engagement.

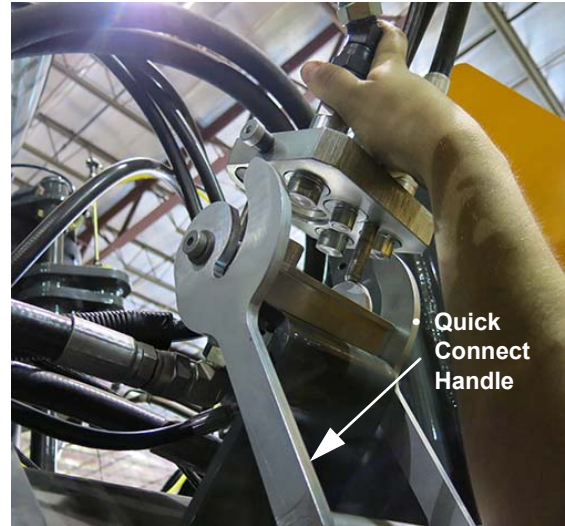

Hydraulic/Electric Multi-Coupler Assembly
(Left-hand side of machine shown)
-Typical View

- Push the Quick Connect Handle UP to engage left-hand hydraulic/electrical connections.
- Press and hold the red Release Button (located on the right-hand quick connect handle) and lower handle into DOWN position.
- Remove the Hydraulic Connection Cover (located on right-hand side of machine) and set aside.

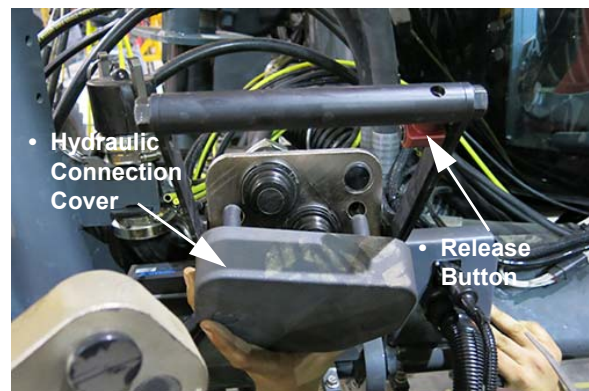

Hydraulic Connection Cover and Release Button
(Right-hand side of machine shown)
-Typical View

- Install the Hydraulic Connection (located on the right-hand side of combo attachment) into the Multi-Coupler Receptacle

(located on right-hand side of machine), ensuring full engagement.

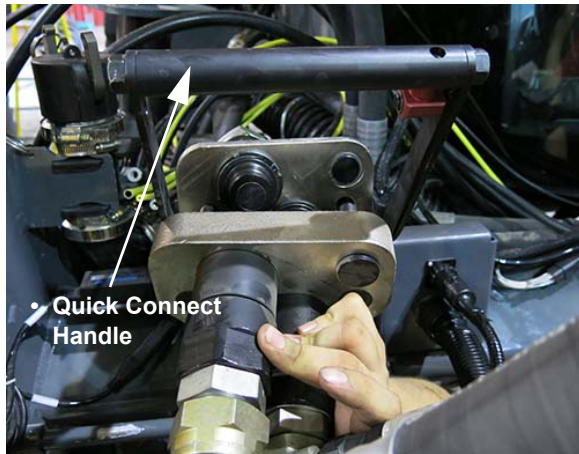

Hydraulic Multi-Coupler Assembly
(Right-hand side of machine shown)
-Typical View

15. Press and hold the red Release Button and push Quick Connect Handle UP to engage right-hand hydraulic connections.
16. Install the Electrical Connections (located on the right-hand side of combo attachment) into the Electrical Ports (located on the right-hand side of machine).

NOTE: Turn Electrical Connections "clockwise" to engage.



Electrical Connections
(Right-hand side of machine shown)
-Typical View

17. Remove the Securement Pins (located on the inward side of each combo attachment stand) and set aside.

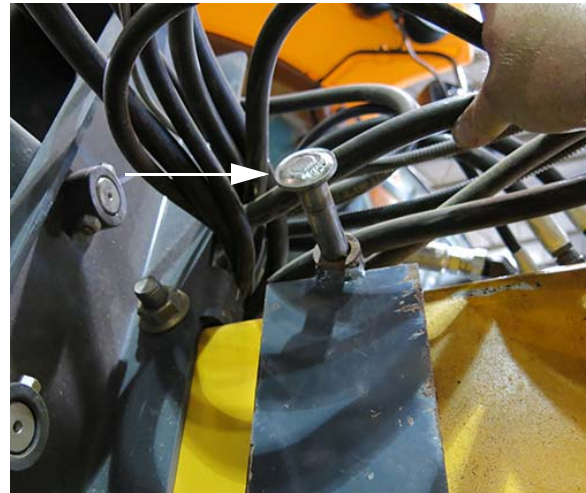

Securement Pin
(Located on the inward side of
each combo attachment stand)
-Typical View

18. Remove the Stop Plate (located on the inward side of each combo attachment stand) and set aside.

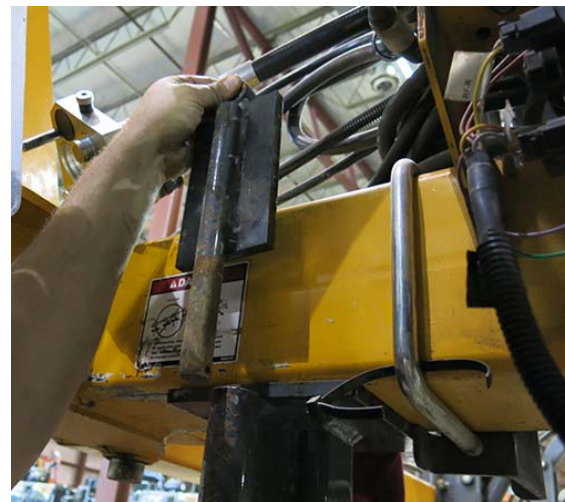

Stop Plate
(Located on the inward side of
each combo attachment stand)
-Typical View

19. Remove the combo attachment stands and set aside.

Disconnecting the Detasseler Combo Attachment

NOTICE

Stagger detasseling heads before folding the outriggers. Failure to comply will result in property damage.

WARNING

Ensure combo attachment is in the fully FOLDED position before detaching from machine. Failure to comply may result in serious injury or death and will result in property damage.

Before disconnecting the combo attachment, determine a proper storage location. When choosing a place to store the attachment, there are three important things to keep in mind:

Is the ground level?

The ground must be level to help prevent the attachment from falling over. Level ground will also minimize stress on the frame of the attachment when in storage.

Is there enough space?

Be aware of the room that is needed for the attachment and adequate space to travel around it safely.

Is it accessible?

The attachment needs to be positioned so you can connect easily. Ensure there is enough room and that the attachment is not blocked, or blocking other items.

If temporarily storing attachment on a soft surface (such as grass), it is recommended to place blocks or wood beneath each of the combo attachment stands to prevent the attachment from sinking into the ground.

NOTE: It is NOT recommended to store the attachment on a soft surface for an extended period of time, due to the risk of settling soil, even when blocks or wood are used.

- Using the corresponding Lift Up/Down Switches (located on the Tasselrol® Control Panel), stagger the detasseling heads.
 - Lower the two center detasseling heads all the way DOWN.
 - Raise all the detasseling heads on one side to approximately half of the fully raised height.
 - Raise the detasseling heads on the opposite side to the fully raised height.



Lift Up/Down Switches
(Located on the Tasselrol Control Panel)
-Typical View



Staggered Detasseling Heads
-Typical View

NOTE: If your DTB is equipped with the 4-2 feature, refer to “4-2 Detasseler Combo Attachment - Adjustable”

provided elsewhere in this manual for information on folding and sequence valve adjustments.

2. Slowly fold the outriggers in by pressing and holding the corresponding Left/Right Fold Switches (located on the Detasseling Control Panel) in the UP (Fold) position, making adjustments (as necessary) to the height of the detasseling heads.



Left/Right Fold Switches
(Located on the Detasseling Control Panel)
-Typical View

NOTICE

Do not attempt to make any adjustments to the detasseling heads after the outriggers are folded. Failure to comply may cause the stalk guides or depth command sensor bars to entangle, resulting in equipment damage.

3. Engage the parking brake.
4. **Turn the engine OFF before disconnecting any hoses or electrical lines!**
5. Install the combo attachment stands beneath attachment.
6. Install Stop Plate and Securement Pin on the inward side of each combo attachment stand.



Stop Plate/Securement Pin Assembly
-Typical View

7. Pull the Quick Connect Handle (located on the left-hand side of machine) DOWN to disengage hydraulic/electrical connections.
8. Remove Hydraulic/Electric Connection from the Multi-Coupler Receptacle.

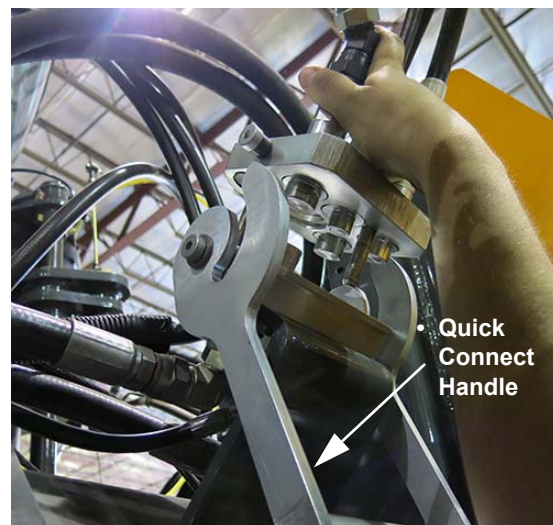

Hydraulic/Electric Multi-Coupler Assembly
(Left-hand side of machine shown)
-Typical View

9. Press and hold the red Release Button (located on the right-hand quick connect handle) and pull handle DOWN to disengage hydraulic connections.

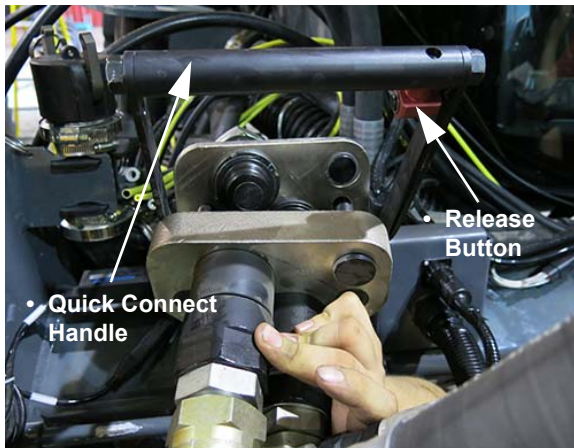

Hydraulic Multi-Coupler Assembly
(Right-hand side of machine shown)
-Typical View

10. Remove Hydraulic Connection from the Multi-Coupler Receptacle.
11. Reinstall Hydraulic Connection Cover (located on right-hand side of machine).

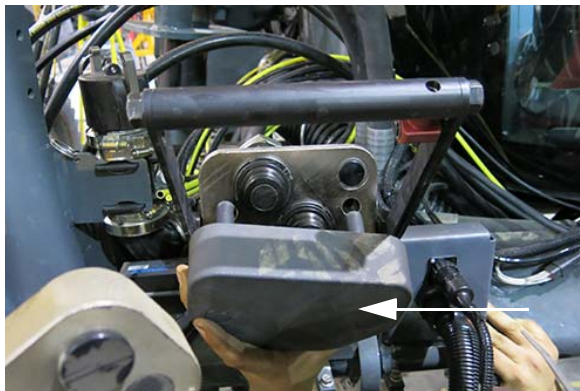

Hydraulic Connection Cover
(Right-hand side of machine shown)
-Typical View

12. Remove the Electrical Connections from the Electrical Ports (located on the right-hand side of machine).

NOTE: Turn Electrical Connections “counter-clockwise” to disengage.



Electrical Connections
(Right-hand side of machine shown)
-Typical View

13. Disengage the Quick-Tach Lock Assemblies by pulling the Lock Pin (located on the front left and right-hand side of machine) OUT as far as it will go until it is in the “lock-out” position.

NOTE: “Lock-out” position prevents re-locking while attaching or detaching the attachment.



Lock Pin (2)
(Located on the front left and right-hand side of machine)
-Typical View
** Disengaged position shown*

14. Start the engine.
15. Lower the machine by rotating the corresponding Air Suspension Valves (located

on the left-hand front air bag) in the COUNTER-CLOCKWISE (Deflate) position.

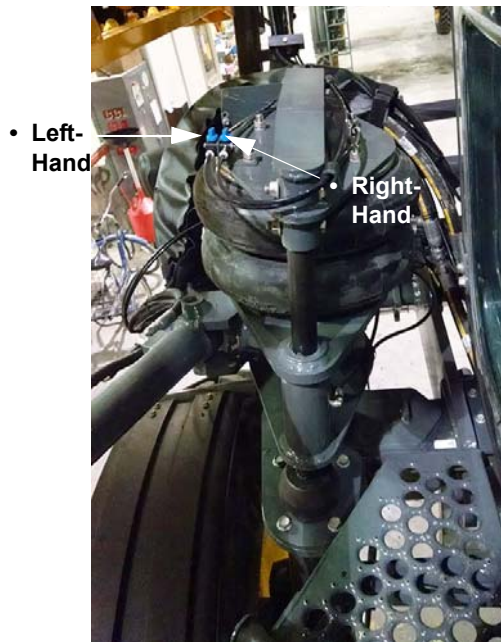

Air Suspension Valves
(Located on the left-hand front air bag)
-Typical View

16. Disengage the parking brake and slowly back away from the combo attachment.
17. If no other attachment is going to be installed, re-lock the Quick-Tach Lock Assemblies by pushing the Lock Pins IN.

NOTE: Install provided covers on disconnection points to avoid damage and contamination. Contact your local John Deere dealer for replacement covers.

18. Raise the machine by rotating the corresponding Air Suspension Valves in the CLOCKWISE (Inflate) position.

ATTACHMENT ASSEMBLY

(Cutter Heads, Quad Pullers, and LS System/Depth Command)

⚠ CAUTION

Engage the parking brake and turn the engine OFF before installing components.

NOTICE

Read and comply with the following attachment instructions. Ensure you have the proper equipment and assistance when installing an attachment.

To ensure proper component installation, refer to your Parts Manual for outlining the installation, hydraulic schematic, and wiring diagrams.

NOTE: Refer to your Parts Manual for correct hardware used when performing the following attachment procedures.

Cutter Head Assembly

⚠ CAUTION



SEVERING OF FINGERS OR HAND.
DO NOT PLACE FINGERS OR HAND NEAR A MOVING CUTTER BLADE, ATTEMPT TO STOP A MOVING CUTTER BLADE, OR PERFORM MAINTENANCE NEAR A MOVING CUTTER BLADE.

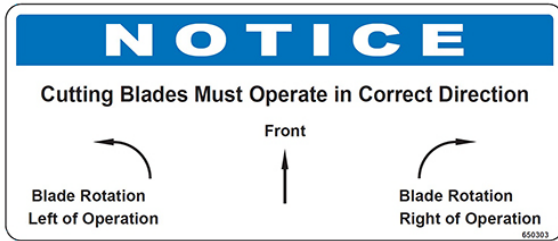

NOTE: Refer to your Parts Manual for specific hardware used.

1. Install two (2) Cutter Heads on each lift head tube, as shown.

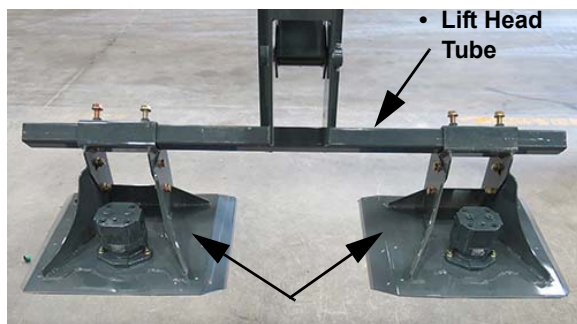

2. Ensure each Cutter Head measures 16" (40.6 cm) from the outside of the mount head to the outside of the cutter head mounting tube, making adjustments as necessary.

NOTE: Distance may vary depending on planting pattern.

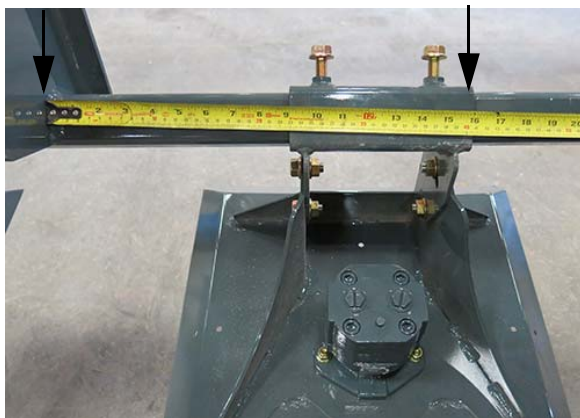

- Measure 16" (40.6 cm) from the outside of the mount head to the outside of the cutter head mounting tube

3. Ensure each Cutter Head measures 30" (76.2 cm) from center of each cutter head motor.

NOTE: Distance may vary depending on planting pattern.

NOTE: Repeat process, measuring across each lift mount.



- Measure 30" (76.2 cm) from center of each cutter head motor



- Measure 30" (76.2 cm) from center of each cutter head motor, across each lift mount

4. Using a 3/4" socket, tighten each Cutter Head Bolt (two on each Cutter Head Mounting Tube).



Cutter Head Bolts
(Located on each
Cutter Head Mounting Tube)
-Typical View

5. Install two Stalk Guides on each Cutter Head, positioned as shown.



- Install eight (8) Stalk Guide Bolts (4 each side) through bottom of each Cutter Head/Stalk Guide.
- Install eight (8) Stalk Guide Nuts (4 each side) onto the bolts and tighten with a 7/16" socket.



Stalk Guide Installation
-Typical View

6. Apply anti-seize lubricant to inside of Cutter Blade Adapter Plug.

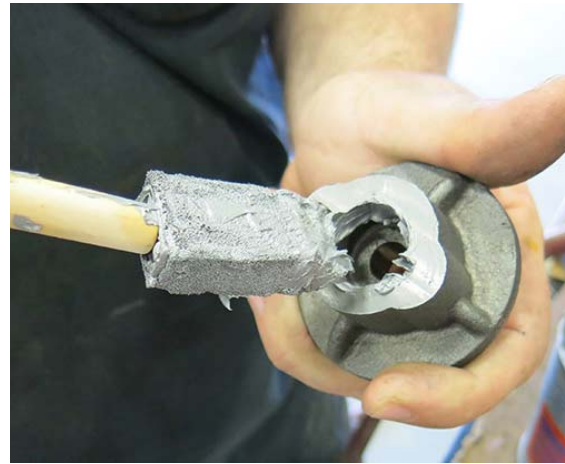

Anti-Seize Lubricant Application
-Typical View

7. Install Cutter Blade Adapter Plug onto center of blade.

NOTE: Ensure adapter plug is installed on the "edged" side of blade, as shown.



- Install Cutter Blade Adapter Plug onto center of blade

8. Assemble Retaining Bolt, Lock Washer, and Steel Washer together, as shown.

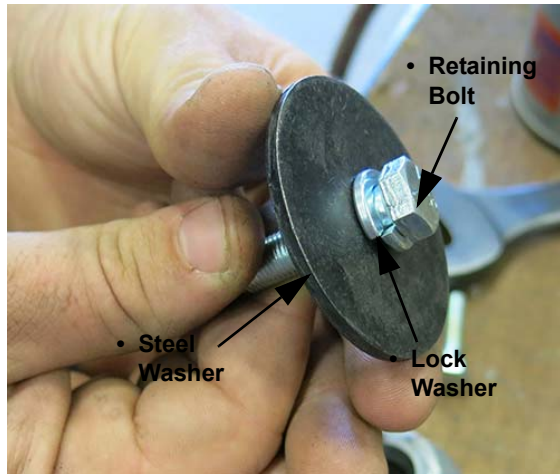

Cutter Blade Bolt/Washer Assembly
-Typical View

9. Insert Cutter Blade Bolt/Washer Assembly through bottom of blade/adaptor plug.



Cutter Blade Assembly
-Typical View

10. Install Cutter Blade Assembly through bottom side of Cutter Head (as shown) and tighten Retaining Bolt using a 9/16" socket. Torque to 37 ft.-lbs.

NOTE: Inspect and tighten Retaining Bolts daily.



Cutter Blade Assembly
(Mounted on the bottom
side of Cutter Head)
-Typical View

NOTE: Repeat Steps 6-10 for each Cutter Head.

11. Install Cutter Head Extension Flap on the rear side of the center four (4) Cutter Heads.



Cutter Head Extension Flap
-Typical View

12. Install hydraulic hoses.

NOTE: Refer to your Parts Manual for correct hardware, hose lengths, and hydraulic schematics.

Quad Puller Assembly

NOTE: Some Quad Pullers may come pre-assembled to the tool bar.

⚠ CAUTION



RISK OF INJURY FROM ROTATING TIRES. DO NOT PLACE FINGERS OR HAND NEAR MOVING QUAD PULLER TIRES, DISLodge A WEDGED OBJECT FROM MOVING TIRES, OR PERFORM MAINTENANCE NEAR MOVING TIRES.

NOTICE

Ensure quad puller tires have equal pressure. Check tire pressure daily.

NOTE: Refer to your Parts Manual for specific hardware used.

1. Install two (2) Quad Pullers on each lift head tube, as shown.



Quad Puller
-Typical View

2. Ensure each Quad Puller measures 16" (40.6 cm) from the outside of the mount head to the outside of the quad puller mounting tube, making adjustments as necessary.

NOTE: Distance may vary depending on planting pattern.

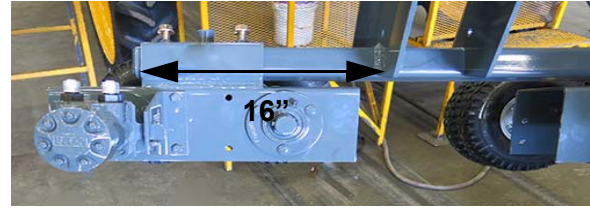

- Measure 16" (40.6 cm) from the outside of the mount head to the outside of the quad puller mounting tube

3. Using a 3/4" socket, tighten each Quad Puller Bolt (two on each Quad Puller Mounting Tube).



Quad Puller Bolts
(Located on each
Quad Puller Mounting Tube)
-Typical View

4. Install two Stalk Guides onto each Quad Puller, positioned as shown.
 - Install four (4) Stalk Guide Bolts (2 each side) through the front side of each Stalk Guide/Quad Puller.
 - Install four (4) Stalk Guide Nuts (2 each side) onto the bolts and tighten with a 7/16" socket.



- Install four (4) Stalk Guide Bolts through the front side of each Stalk Guide/Quad Puller



- Install four (4) Stalk Guide Nuts onto the bolts and tighten with a 7/16" wrench



Stalk Guide Installation
-Typical View

5. Install Deflector Shield Mounting Tube onto each Quad Puller (as shown) and tighten bolts with 7/16" wrench.

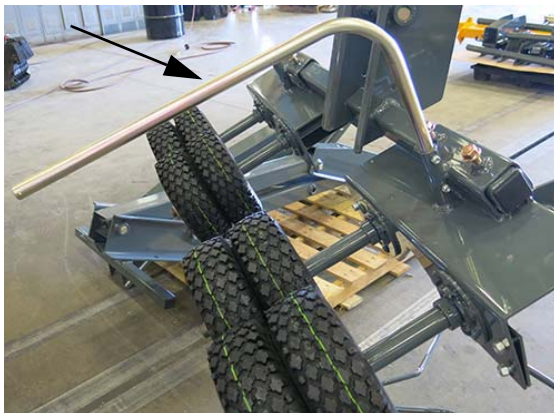

Deflector Shield Mounting Tube
-Typical View

6. Install Deflector Shield onto Deflector Shield Mounting Tube and tighten bolts with 1/2" wrench.

NOTE: Always mount Deflector Shields to direct tassels away from machine.

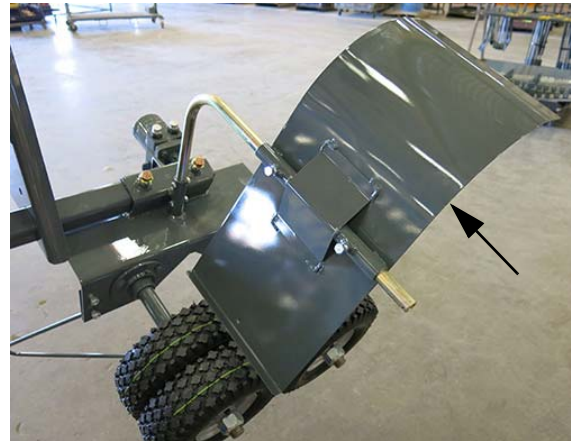

Deflector Shield
-Typical View

7. Install Cotter Pin on the end of each Deflector Shield Mounting Tube.



Cotter Pin
-Typical View

8. Install hydraulic hoses.

NOTE: Refer to your Parts Manual for correct hardware, hose lengths, and hydraulic schematics.

9. Adjust tire pressure to approximately 10 psi (.7 bar).

LS System/Depth Command Assembly

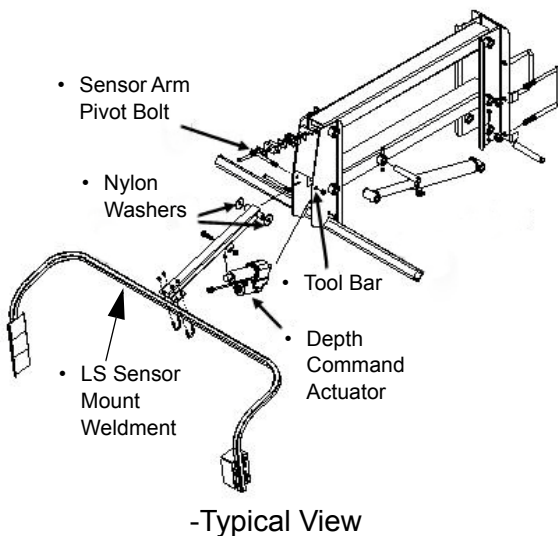

1. Install the LS Sensor Mount Weldment with the two Nylon Washers in the forward-most hole of the Tool Bar.
2. Install the LS Sensor Mount Weldment to the Sensor Mount (located on the support arm).
3. Install the Cable Assembly according to the wiring diagram provided in your Parts Manual.
4. Check sensor installation by turning the ignition key to the ON position. DO NOT start the engine.
5. Attach the Depth Command Actuator to the Light Sensor Mount and Tool Bar.

NOTICE

Over-tightening of the Sensor Arm Pivot Bolt may cause the actuator to stall.

TROUBLESHOOTING

Problem	Possible Cause	Suggested Remedy
Lifting mechanism will not lift	<ul style="list-style-type: none"> • Bad cylinder • Blown relief valve • Relief valve set too low • Lift arms seized • Faulty electro-hydraulic valve 	<ul style="list-style-type: none"> • Check cylinder - remove and rebuild or replace • Remove, inspect, replace • Contact your local John Deere dealer for assistance • Loosen mounting bolts, lubricate grease fittings (if equipped) • Refer to the Tasselrol® user guide
Cutter head blades, quad pullers, rollers, or ties will not turn	<ul style="list-style-type: none"> • Oil level in reservoir too low • Oil not reaching pump • Faulty hydraulic pump • Faulty hydraulic motor(s) 	<ul style="list-style-type: none"> • Fill reservoir to proper level with approved oil • Remove suction hose from pump and check for proper flow, reinstall hose and all suction fittings • Replace hydraulic pump • Replace motor(s)
Hydraulic motor leaking	<ul style="list-style-type: none"> • Seal failure • Restricted case drain hose 	<ul style="list-style-type: none"> • Replace seal, turn heads on with low engine RPM • Inspect or replace hose
No units will lift	<ul style="list-style-type: none"> • Oil in hydraulic reservoir low • Faulty valve • Relief valve in electro-hydraulic valve set too low 	<ul style="list-style-type: none"> • Fill reservoir to proper level • Repair or replace valve • Contact your local John Deere dealer for assistance
No units will lower	<ul style="list-style-type: none"> • Lift arm pivots too tight 	<ul style="list-style-type: none"> • Lubricate and loosen pivot points
Only one unit will not lower	<ul style="list-style-type: none"> • Faulty valve • Lift arm pivot too tight 	<ul style="list-style-type: none"> • Replace valve • Lubricate and loosen pivot point
All units lift slowly	<ul style="list-style-type: none"> • Hydraulic oil not at operating temperature • Faulty valve • Lift arm pivots too tight • Relief valve in electro-hydraulic valve system set too low 	<ul style="list-style-type: none"> • Allow time for oil to warm up • Replace valve • Lubricate and loosen pivot points • Contact your local John Deere dealer for assistance
Only one unit lifts slowly	<ul style="list-style-type: none"> • Faulty valve • Lift arm pivot points too tight 	<ul style="list-style-type: none"> • Replace valve • Lubricate/loosen pivot points

<p>Only one unit will not hold position</p>	<ul style="list-style-type: none"> • Oil leak between valve and cylinder • Faulty valve • Faulty lower poppet on lift valve 	<ul style="list-style-type: none"> • Repair leak or replace hose • Replace valve • Remove, clean/replace
<p>No units will hold position</p>	<ul style="list-style-type: none"> • Non-hydraulic issue 	<ul style="list-style-type: none"> • Refer to the Tasselrol information elsewhere in this manual
<p>Only one unit lowers slowly</p>	<ul style="list-style-type: none"> • Faulty valve • Faulty lower poppet on lift valve 	<ul style="list-style-type: none"> • Replace valve • Remove, clean/replace
<p>All units lower slowly</p>	<ul style="list-style-type: none"> • Hydraulic oil not at operating temperature 	<ul style="list-style-type: none"> • Allow time for oil to warm up
<p>In MANUAL mode, more than one unit lifts or lowers using one up/down switch</p>	<ul style="list-style-type: none"> • Faulty valve 	<ul style="list-style-type: none"> • Replace valve

In AUTO mode, more than one unit raises from photo sensor	<ul style="list-style-type: none"> Faulty valve 	<ul style="list-style-type: none"> Replace valve
In AUTO mode, wrong unit raises from photo sensor	<ul style="list-style-type: none"> Cylinder hoses are connected to the wrong cylinder Electronic malfunction 	<ul style="list-style-type: none"> Attach correct hoses to proper cylinder Contact your local John Deere dealer for assistance
No units will lift	<ul style="list-style-type: none"> Faulty Auto/Manual Switch Blown Fuse Faulty #1 valve, coil, or loose coil mounting nut Loose wire connections Faulty wire connections Faulty main wire assembly 	<ul style="list-style-type: none"> Replace switch Find short in wire, repair, and replace fuse Tighten or replace coil Find loose connection, tighten Replace or repair Replace or repair
Only one unit will not lift	<ul style="list-style-type: none"> In MANUAL mode, faulty Up/Down Switch Light photo sensor assembly Faulty valve, coil, or loose coil mounting nut Loose wire connections Photo sensor lights not lined up with reflector Faulty row wire assembly Faulty sensor connector wire 	<ul style="list-style-type: none"> Replace control box Replace photo sensor Tighten nut or replace coil Find loose connections, tighten Line up sensor with reflector Replace or repair Replace or repair
No units will lower	<ul style="list-style-type: none"> Faulty Auto/Manual Switch Blown fuse In AUTO mode, LS valve assembly unplugged Loose wire connection 	<ul style="list-style-type: none"> Replace switch Find short in wire, repair, and replace fuse Plug in wire assembly Find loose connection, tighten
Only one unit will not lower	<ul style="list-style-type: none"> Faulty Up/Down Switch Light photo sensor inoperable Faulty valve, coil, or loose coil mounting nut Loose wire connection Lights of photo sensor not lined up with reflector Faulty row wire assembly Faulty sensor connector wire assembly 	<ul style="list-style-type: none"> Replace control box Replace photo sensor Tighten nut or replace coil Find loose connection, tighten Line up sensor with reflector Replace or repair Replace or repair
No units will hold position	<ul style="list-style-type: none"> In AUTO mode, no crop moving under assemblies 	<ul style="list-style-type: none"> Drive forward or select MANUAL mode
In AUTO mode, wrong unit raises from sensor assembly	<ul style="list-style-type: none"> Row LS wire assembly plugged into wrong sensor connector 	<ul style="list-style-type: none"> Plug correct wire assembly into proper row sensor connector assembly

Machine Valve Type

- **o** = Any machine with original valve (Model Year 2007 or prior).
- **p** = 204/204SP machines with proportionate valve (Model Year 2008 and later).
- **c** = STS Combination Sprayer/Detasseler with proportionate valve (Model Year 2007 or later).
- **x** = 204XP and DTS 8C (Combination Sprayer/Detasseler) with 12 valves (Model Year 2010).

Tasseltrol/LS System

- Turn the ignition key to the ON position (do not start the engine).
- Turn the Tasseltrol Control Panel to the ON position.
- Turn the Auto/Manual Switch to MANUAL.
- Ensure there is nothing physically blocking any upper or lower sensor's path to its reflector.

The display will show the status of the upper and lower photo sensor on each lift assembly. If the display shows a box ("□") in all upper and lower areas, the unit is ready for operation. If the display shows a corn stalk ("✚") in one or more areas, refer to the following information for troubleshooting.

NOTE: Left-center sensors used as examples.

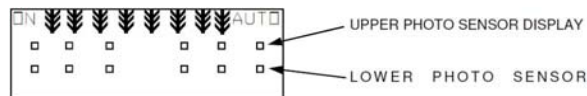

Tasseltrol Display

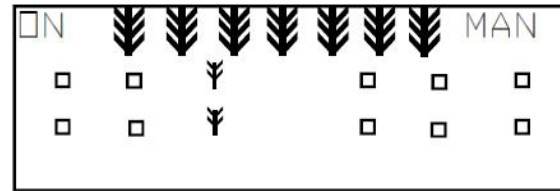

Manual Mode

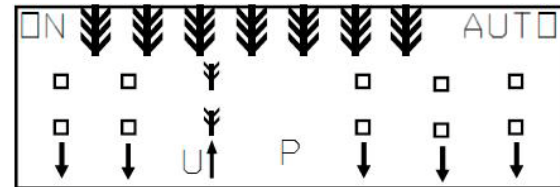

Auto Mode

Unit rises automatically

Photo Sensor Light Status	Possible Cause
Lights at both photo sensors	<ul style="list-style-type: none"> • Photo sensors not in line with reflector. Contact your local John Deere dealer for assistance.
No lights at either photo sensor	<ul style="list-style-type: none"> • Faulty connector cable (refer to your Parts Manual) • Faulty wire in connector cable (refer to your Parts Manual)

Tasselrol Display

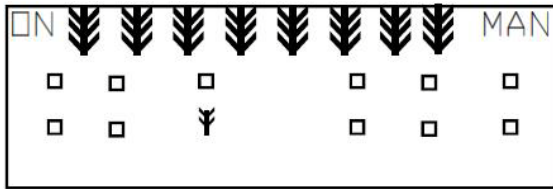

Manual Mode

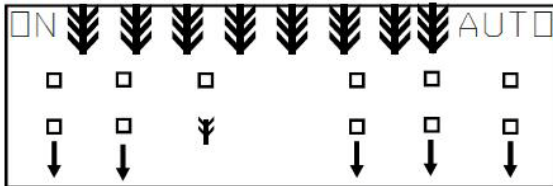

Auto Mode

Tasselrol Display

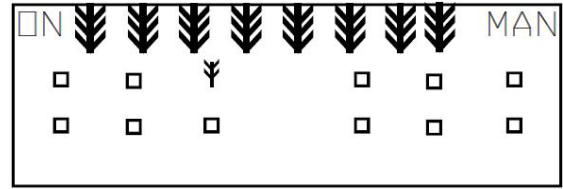

Manual Mode

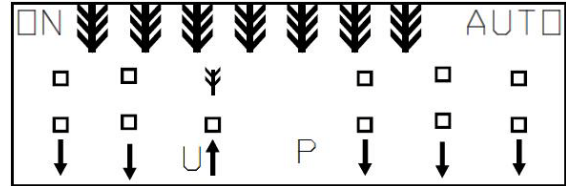

Auto Mode

Unit does NOT rise automatically

Photo Sensor Light Status	Possible Cause
Lights at lower photo sensor	<ul style="list-style-type: none"> Faulty wire in connector cable (refer to your Parts Manual) Photo sensor not in line with reflector. Contact your local John Deere dealer for assistance. Faulty wire in sensor assembly (refer to your Parts Manual)
No lights at lower photo sensor	<ul style="list-style-type: none"> Faulty wire in connector cable (refer to your Parts Manual)

Photo Sensor Light Status	Possible Cause
Lights at upper photo sensor	<ul style="list-style-type: none"> Faulty wire in sensor assembly (refer to your Parts Manual)
No lights at upper photo sensor	<ul style="list-style-type: none"> Faulty wire in connector cable (refer to your Parts Manual)



INDEX

4-2 Detasseler Attachment -	
Adjustable	3-10
A Word From Hagie Manufacturing	
Company	1-1
About This Manual	1-1
Attachment Assembly	5-10
Detasseling System - Operation	3-8
Detasseling System Components	3-1
Fold Procedure - Detasseler Tool Bar ...	3-6
Identification	1-2
Intended Use	2-1
Operator Presence Switch (OPS)	2-3
Product Warranty	1-2
Quick-Tach System - Detasseler Tool	
Bar	5-3
Safety Decals	2-4
Safety Messages Used In This	
Manual	1-2
Safety Precautions	2-1
Service - Lubrication	4-1
Service and Assistance	1-2
Service Intervals	4-3
Specifications	1-4
Storage	4-4
Tasselrol Flowchart	3-22
Tasselrol®/LS System 12™	3-13
Transporting	5-1
Troubleshooting	5-17

