

**CALIFORNIA
Proposition 65 Warning**

Diesel engine exhaust and some of its constituents are known to the State of California to cause cancer, birth defects, and other reproductive harm.

**2021 D400
OPERATOR'S MANUAL
493881**



HAGIE
CONTENTS

1 – INTRODUCTION

A Word From Hagie Manufacturing Company	1-1
About This Manual	1-1
Safety Messages Used In This Manual	1-2
Service and Assistance	1-2
Product Warranty	1-3
Identification	1-3
Sound Level	1-4
Whole Body Vibration	1-4
Specifications	1-6
Torque Values	1-15

2 – SAFETY AND PRECAUTIONS

Intended Use	2-1
Safety Precautions	2-1
Operator Presence Switch (OPS)	2-6
Seat Belt	2-7
Rotating Beacon	2-7
Emergency Stop	2-7
Emergency Exit	2-8
Fire Extinguisher	2-9
Safety Decals	2-9

3 – CAB

Seat - Operator (Standard)	3-1
Seat - Operator (Premium)	3-4
Seat - Instructor	3-7
Operator's Station	3-7
Machine Display	3-24

4 – ENGINE AND DRIVE SYSTEMS

Engine - Starting	4-1
Engine Aftertreatment - Final Tier 4	4-3
Hydrostatic Drive	4-10
All-Wheel Steer (AWS)	4-15

5 – HYDRAULIC SYSTEMS

Hydraulic System Components	5-1
Reversible Fan - Variable Pitch	5-4
Tread Adjustment - Hydraulic	5-6
Ladder	5-9

6 – ELECTRICAL SYSTEMS

Batteries	6-1
Battery Disconnect Switch	6-2
Fuses and Relays	6-4
Fuse and Relay Ratings	6-8

7 – DETASSELING SYSTEMS

Detasseling System Components	7-1
Fold Procedure - Detasseler Tool Bar	7-6
Detasseling System - Operation	7-9
Tasselrol™ XL/LS System 12	7-11
Attachment Assembly	7-14

8 – MAINTENANCE AND STORAGE

Service - Fluids	8-1
Service - Filters	8-11
Service - Lubrication	8-21
Service - Engine Drive Belt	8-24
Service - Bolt Torque	8-25
Service - Toe-In	8-28
Service - Air Springs	8-30
Service - Miscellaneous	8-31
Service Intervals	8-33
Storage	8-36

9 – MISCELLANEOUS

Transporting	9-1
Towing	9-4
Lifting Your Machine	9-6
Air Suspension Exhaust	9-8
Viscous Clutch Fan	9-8
Electric Hood	9-10
Front End Access	9-11
Tread Adjustment - Manual	9-12
Tall Crop Package - Installation	9-15
Troubleshooting	9-22



SECTION 1 – INTRODUCTION

A WORD FROM HAGIE MANUFACTURING COMPANY

Congratulations on the purchase of your D400 Detasseler! Read this operator's manual and become familiar with operating procedures and safety precautions before attempting to operate your machine.

As with any piece of equipment, certain operating procedures, service, and maintenance are required to keep your machine in top running condition. We have attempted herein to cover all of the adjustments required to fit varying conditions. However, there may be times when special care must be considered.

NOTE: The operator is responsible for inspecting the machine and having parts repaired or replaced when continued use of the product causes damage or excessive wear to other parts.

Hagie Manufacturing Company reserves the right to make changes in the design and material of any subsequent detasseler without obligation to existing units.

Thank you for choosing a Hagie detasseler and we ensure you of our continued interest and support in its optimal performance for you. We are proud to have you as a customer!

ABOUT THIS MANUAL

NOTICE

Any pictures or illustrations contained within this manual that depict situations with shields, guards, rails, or lids removed are for demonstration only. Keep all shields and safety devices in place at all times.

This manual will aid you in the proper operation and service of your machine. It is the responsibility of the user to read the operator's manual and comply with the correct and safe operating procedures, as well as maintain the product according to the service information provided in the *Maintenance and Storage Section* elsewhere in this manual.

Photographs and illustrations used in this manual are of general nature only. Some of the equipment and features shown may not be available on your machine.

Information described in this manual was correct at the time of printing. Because of Hagie Manufacturing Company's continuous product improvement, certain information may not be included in this manual. To obtain the most current operator's manual for your machine, please visit www.hagie.com.

Keep this manual in a convenient place for easy reference. This manual is considered a permanent fixture of the product. In the event of resale, this manual must accompany the machine.

If you do not understand any part of this manual or require additional information or service, contact your local John Deere dealer for assistance.

SAFETY MESSAGES USED IN THIS MANUAL

The following safety messages found throughout this manual alert you of situations that could become potentially dangerous to the operator, service personnel, or equipment.

⚠ DANGER

The signal word DANGER indicates a hazardous situation which, if not avoided, will result in death or serious injury.

⚠ WARNING

The signal word WARNING indicates a hazardous situation which, if not avoided, could result in death or serious injury.

⚠ CAUTION

The signal word CAUTION indicates a hazardous situation which, if not avoided, could result in minor or moderate injury. CAUTION may also be used to alert against unsafe practices associated with events which could lead to personal injury.

NOTICE

The signal word NOTICE indicates operator awareness which, if not avoided, may result in personal or property damage.

NOTE: A “Note” is intended to make special mention of, or remark on.

SERVICE AND ASSISTANCE



John Deere Is At Your Service

Customer satisfaction is important to Hagie and John Deere. Our dealers strive to provide you with prompt, efficient parts and service:

- Maintenance and service parts to support your equipment.
- Trained service technicians and the necessary diagnostic and repair tools to service your equipment.

Customer Satisfaction Problem Resolution Process

Your John Deere dealer is dedicated to supporting your equipment and resolving any problem you may experience.

1. When contacting your dealer, be prepared with the following information:
 - Machine model and product identification number.
 - Date of purchase.
 - Nature of problem.
2. Discuss problem with dealer service manager.
3. If unable to resolve, explain problem to dealership manager and request assistance.
4. If you have a persistent problem your dealership is unable to resolve, ask your dealer to contact John Deere for assistance, or contact the Ag Customer Assis-

tance Center at 1-866-99DEERE (866-993-3373) or e-mail us at www.deere.com/en_US/ag/contactus.

PRODUCT WARRANTY

Please contact your local John Deere dealer for further information.

IDENTIFICATION

NOTICE

Reference to right and left-hand used throughout this manual refers to the position when seated in the operator's seat facing forward.

Each machine is identified by means of a frame serial number. This serial number denotes the model, year in which it was built, and the number of the sprayer.

For further identification, the engine and hydraulic pumps each have serial numbers, and the planetary wheel motor/hubs have identification plates that describe the type of mount and gear ratio.

To ensure prompt, efficient service when ordering parts or requesting service repairs, record the serial numbers and identification numbers in the following spaces provided.

Machine

The machine serial number is stamped on the front right-hand side of frame (behind the front leg).

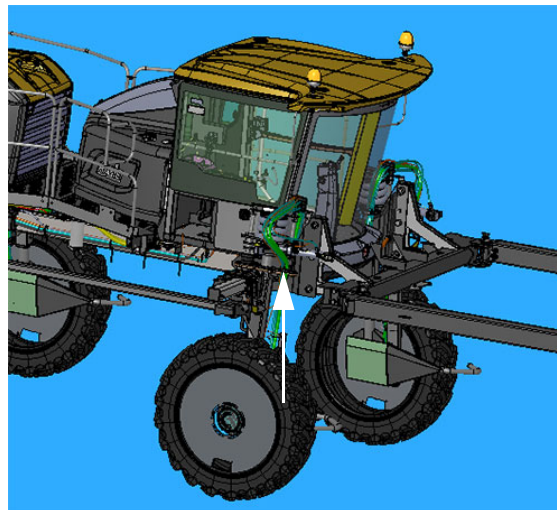

Machine Serial Number
-Typical View

Serial No. _____

Engine

The engine has an identification plate mounted on top of the engine that provides engine serial number, as well as other manufacturer information. Refer to your Parts Manual for specific part number.

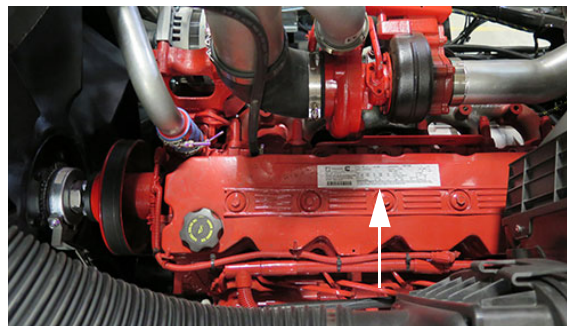

Engine Identification Plate
-Typical View

Serial No. _____

Hydraulic Pumps

The PC and Drive Pumps each have an identification plate mounted on the side of pump that provides pump serial number, as well as other manufacturer information. Refer to your Parts Manual for specific part number.

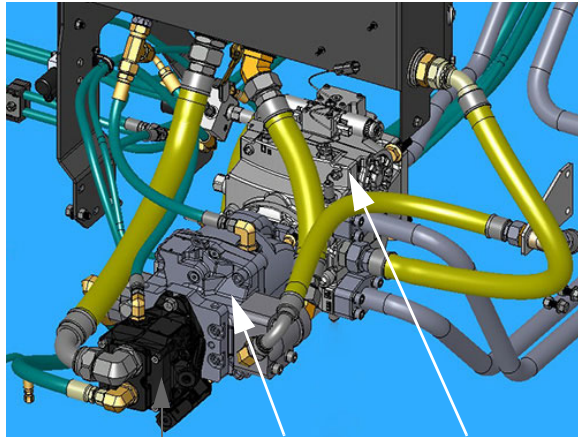

- PC Pump
- LS Pump
- Drive Pump

Hydraulic Pumps
-Typical View

- _____ PC Pump
- _____ LS Pump
- _____ Drive Pump

Wheel Motor/Hubs

Each wheel motor/hub assembly has an identification plate mounted on the rear side of the hub that provides serial number, as well as other manufacturer information, including gear ratio. Refer to your Parts Manual for specific part number.

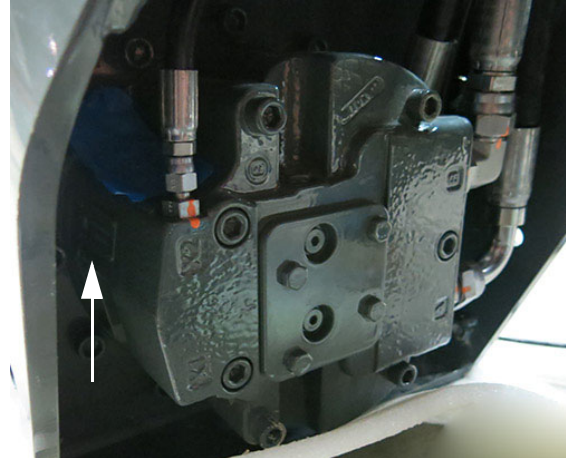

Wheel Motor/Hub Assembly
-Typical View

- _____ Right Front
- _____ Right Rear
- _____ Left Front
- _____ Left Rear

SOUND LEVEL

The highest A-weighted sound pressure level inside the operator's station range from 74.6 dB(A) to 75.5 dBA as measured in accordance with ISO 5131. These sound pressure levels depend on the speed at which the machine is operated, the maintenance of the machine, and the operator's experience and operational habits.

WHOLE BODY VIBRATION

The weighted root mean square acceleration to which the whole body is subjected to ranges from 0.42 to 0.59 m/s² as measured on a representative machine during typical operations and analyzed in accordance with ISO 2631. During the same operations, the weighted root mean square hand-arm vibration is subjected to ranges

from 0.21 to 0.59 m/s² when analyzed in accordance with ISO 5349. These acceleration levels depend on the roughness of the ground, the speeds at which the machine is operated, the maintenance of the machine and the operator's experience, weight, and driving habits.

SPECIFICATIONS

Machine Dimensions

NOTE: Dimensions on your machine may vary, depending on tire size.

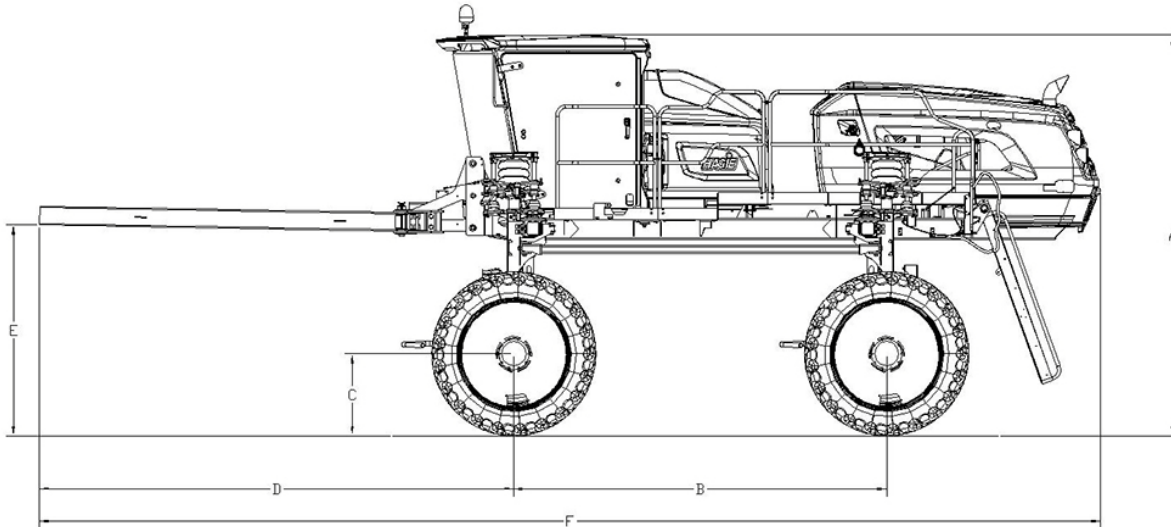

Detail	Description	Specification
A	Overall Machine Height (from top of cab) <i>NOTE: Overall machine height dimension does not include the cab-mounted rotating beacons.</i>	<ul style="list-style-type: none"> • 149.5"/379.3 cm (air bags inflated) ** • 144"/365.8 cm (air bags deflated) **
B	Wheel Base (center to center)	138.6"/352 cm
C	Static Loaded Hub Height (from center of hub)	28.5"/72.4 cm**
D	Tool Bar Length (from front of tool bar to center of wheel hub)	180.4"/458.2 cm
E	Tool Bar Height (from bottom of tool bar tube to ground)	69.3"/176 cm**
F	Overall Machine Length (with tool bar)	414.5"/10m
G	Overall Machine Width (from outer left-hand mainframe axle tube to outer right-hand mainframe axle tube)	146.8"/372.9 cm
H	Frame Clearance (from bottom of mainframe axle tube)	72"/182.9 cm**
I	Lower Leg Clearance (from bottom of wheel shield)	22.1"/56.1 cm**
J	Tread Width*	<ul style="list-style-type: none"> • 120"/304.8 cm (In)** • 160"/406.4 cm (Out)**

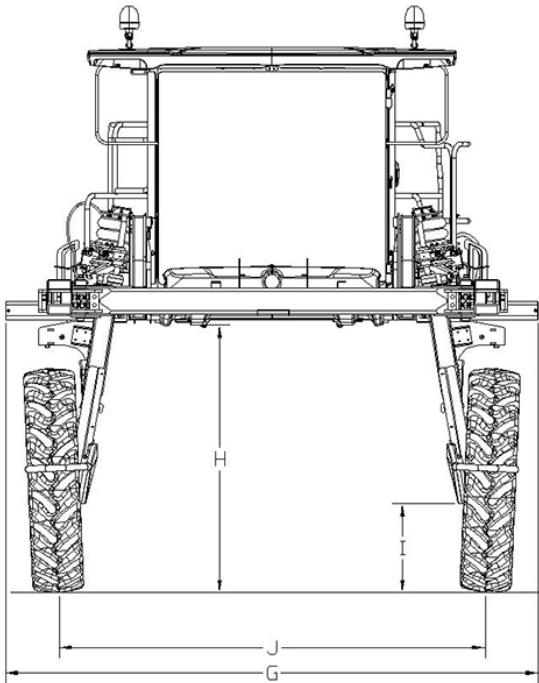

* Tread width is measured from center of tire at ground.

** Refer to “Tire Specifications” provided in the machine operator’s manual for a complete listing of tire options when configuring specifications on your model.

General Information

NOTICE

Because Hagie Manufacturing Company offers a variety of options, the illustrations in this manual may show a machine equipped other than standard. Height and weight values may vary, depending on available equipment.

- **Frame Type:** 4 x 8” (10.2 x 20.3 cm) modular platform frame
- **Suspension:** 4-wheel, individual, air-ride
- **Shipping Width:** 146.8”/372.9 cm (from outer left-hand mainframe axle tube to outer right-hand mainframe axle tube)
- **Approximate Dry Weight:** 20,900 lbs./9,480 kg

Machine Specifications

Description	Specification
Engine	
Manufacturer	Cummins®
Model	QSB 6.7
Type	Electronic with air-to-air cooler and turbo charger
Number of Cylinders	6
Displacement	6.7 liters (408.9 c.i.)
Horse Power	<ul style="list-style-type: none"> • Final Tier 4 - 195 hp/145KW • Tier 3 - 190 hp/141KW (Export only)
Fuel Type	<ul style="list-style-type: none"> • Final Tier 4 - Ultra-Low Sulfur Diesel (ULSD) • Tier 3 - No. 2 Diesel (Export only)
Fuel System	Filtered, direct-injected
Air Cleaner	Dry-type, dual element
Engine Air Filter Restriction Monitors	Filter Minder®
Slow Idle	850 RPM
Fast Idle (no load)	2300 RPM
Hydrostatic Drive	
Hydrostatic Pump	Danfoss H1-Series
Drive Train	All-Wheel 4-Wheel Drive
Speed Ranges	<ul style="list-style-type: none"> • Speed Range 1 (0-13 mph, 0-20 km/h)* • Speed Range 2 (0-19 mph, 0-30 km/h)* • Speed Range 3 (0-28 mph, 0-45 km/h)* - Road Mode only <p>* Speed ranges may vary, depending on tire size.</p>
Wheel Motors/Final Drive	Fairfield Torque-Hub® (CT07)
• Lubrication	Oil bath
Brakes (Parking)	Multiple disk, spring applied, hydraulically released
Auxiliary Hydraulic System	
Steering System	Hydraulic, priority circuit
• Control	Full-time power
• Steering Cylinders	Double acting

<ul style="list-style-type: none"> • Turning Radius[^] (Measured from center point to center of tracks) <i>NOTE: May vary, depending on tire size.</i> 	<ul style="list-style-type: none"> • 12.04 ft./3.5 m (AWS “On”, if equipped) • 19.29 ft./5.5 m (No AWS/AWS “Off”)
All Wheel Steer (AWS) - if equipped[^]	Coordinated steering
Electrical System	
General Electrical System	
• Battery	Dual 12V, negative ground (CCA)
• Alternator	160 AMP, voltage regulated
• Starter	12V with solenoid
Lights (Exterior)	
• Front of Cab	2 trapezoidal headlights, 2 floodlights, 2 rotating amber beacon lights
• Rear Engine Hood	2 round red lights, 2 round amber lights
Cab and Instruments	
Sound Level (cab interior)	74.6-75.5 dBa
Cab (General)	Tilt steering, wipers/washers, dual side mirrors, dome light, tinted glass, instructor seat
Cab Door Width	22” (55.9 cm)
Temperature Control	Full range
A/C Charge Type	R-134A
Fresh Air Filtration	<ul style="list-style-type: none"> • RESPA® cab filter • Charcoal filter
Seat	<ul style="list-style-type: none"> • Mechanical (standard) • Air-ride (optional)
Instruments	Tachometer (RPM), fuel level, engine coolant temperature, after-treatment level
Machine Display	Hour meter, battery voltage, engine oil pressure, ground speed, engine diagnostics, tread adjustment, parking brake, machine/engine malfunction warnings, engine exhaust filtration warning, high exhaust temperature warning, low hydraulic oil level, low coolant level, low fuel level, grid heater, cab air pressure
Stereo	AM/FM radio, MP3, Bluetooth
Fluid Capacities	
Fuel Tank	100 gallons (378.5L)
Engine Oil Pan (including filter and cooler)	17.6 quarts (16.7L), John Deere Plus-50™ II
Engine Oil Dipstick (L-H mark)	2 quarts (1.9L)

SECTION 1 – INTRODUCTION



Engine Cooling System (including block, lines, and radiator)	<ul style="list-style-type: none"> • Final Tier 4 - 10 gallons (37.5L), John Deere Cool -Gard™ II • Tier 3 - 9.55 gallons (36.2L), John Deere Cool -Gard™ II (Export only)
Diesel Exhaust Fluid (DEF) Tank (Final Tier 4 Engines)	5 gallons (18.9L), John Deere Diesel Exhaust Fluid (DEF)
Hydraulic Oil (including lines, filter, cooler, etc.)	39 gallons (147.5L), John Deere Hy-Gard™
Hydraulic Oil Reservoir	25 gallons (94.5L)
Wheel Hubs (4)	27 oz. (.8L)/each, 75W-90 gear oil
Air Conditioning System (Charge)	3.50 lbs. (1.59 kg), R-134A
Detasseling System	
General	
• Monitors/Controls	Machine Display (Tasselrol™ XL)
• General System	Light sensing system, depth command, electrical disconnect, hydraulic couplers
Outriggers	
• 12-Row	134"/340.4 cm (1 left, 1 right)
• 8-Row	75"/190.5 cm (1 left, 1 right)
Quad Pullers	
• Number of Rows Available	6, 8, 10, or 12
• Drive	Hydraulic
• Tire Size	4.10/3.50 2-ply
• Tire Pressure	10 PSI/.7 bar
• Operating Speed	<ul style="list-style-type: none"> • Min Speed = 375 RPM • Mid Speed = 400 RPM • Max Speed = 425 RPM <p><i>NOTE: It is recommended to set the quad pullers as close to "mid" speed range as possible.</i></p>
• Pulling Height	<ul style="list-style-type: none"> • Minimum Range = 32-97" (81.3-246.4 cm) • Maximum Range = 40-105" (101.6-266.7 cm)



SECTION 1 – INTRODUCTION

• Weight (per assembly)	86 lbs. (39 kg)
Cutter Heads	
• Number of Rows Available	6, 8, 10, or 12
• Drive	Hydraulic
• Blade Size	18"/45.7 cm
• Operating Speed	<ul style="list-style-type: none">• Min Speed = 2900 RPM• Mid Speed = 3000 RPM• Max Speed = 3100 RPM <i>NOTE: It is recommended to set the cutter heads as close to "mid" speed range as possible.</i>
• Cutting Height	<ul style="list-style-type: none">• Minimum Range = 29-94" (73.7-238.8 cm)• Maximum Range = 13-102" (33-259.1 cm)
• Weight (per assembly)	62 lbs. (28 kg)

^ Operators with machines equipped with All-Wheel Steer (AWS) pay special attention.

Tire Specifications

NOTICE

Do not exceed tire load limit. Failure to comply will result in weight overload and will void the warranty.

TIRE SPECIFICATIONS (STANDARD)										
Size	Make	Model	Load Rating (Weight/Speed)	Air Pressure (Max PSI)	Tread Width (inches)	Load Capacity (lbs.)	Overall Diameter (inches)	Static Load Radius* (inches)	Rolling Circum. (inches)	Gross Flat Plate (in ²)
380/80R38	Goodyear®	Ultra Sprayer	155A8/B	64	14.6	8,550	62.4	28.2	188	217
IF320/80R42	Goodyear	Super Traction	149D	49	11.7	7,150	62.4	28.2	188	205
380/80R38	Alliance	Farm Pro	152A8/B	58	14.8	7,850	62.1	28.7	185.9	231
300/85R42	Mitas	AC90	144A8	58	11.7	5,678	62	29.1	185.6	177

TIRE SPECIFICATIONS (METRIC)										
Size	Make	Model	Load Rating (Weight/Speed)	Air Pressure (Max Bar)	Tread Width (cm)	Load Capacity (kg)	Overall Diameter (cm)	Static Load Radius* (cm)	Rolling Circum. (cm)	Gross Flat Plate (cm ²)
380/80R38	Goodyear	Ultra Sprayer	155A8/B	4.4	37	3,878	158.4	71.6	477.5	1,399.9
IF320/80R42	Goodyear	Super Traction	149D	3.4	29.7	3,243	158.4	71.6	477.5	1322.6
380/80R38	Alliance	Farm Pro	152A8/B	4.0	37.5	3,560	157.7	72.8	472.2	1,490.3
300/85R42	Mitas	AC90	144A8	4.0	29.9	2,575	157.4	74.0	471.5	1,141.9

* Static load radius is suggested and will vary with load.

NOTICE

The following tire inflation pressures shown may be +/- 2%, depending on tire option.

TIRE LOAD LIMITS (LBS) AT VARIOUS COLD INFLATION PRESSURES (PSI)											
		Inflation (psi)	6	9	12	15	17	20	23	26	29
380/80R38	Goodyear		N/A	N/A	3860	4400	4940	5520	6000	6400	6600
IF320/80R42	Goodyear		N/A	N/A	3200	3640	4080	4540	4940	5200	5520
380/80R38	Alliance		N/A	N/A	N/A	N/A	N/A	N/A	4640	4900	5040
300/85R42	Mitas		N/A	N/A	N/A	N/A	N/A	N/A	3594	N/A	3947

TIRE LOAD LIMITS (LBS) AT VARIOUS COLD INFLATION PRESSURES (PSI) (CONTINUED)											
		Inflation (psi)	35	41	46	52	58	64			
380/80R38	Goodyear		7150	7850	8250	9350	N/A	10200			
IF320/80R42	Goodyear		5840	6400	6950	N/A	N/A	N/A			
380/80R38	Alliance		5340	N/A	6350	6750	7150	N/A			
300/85R42	Mitas		4201	4608	4983	5314	5678	N/A			

NOTE: There are no adjustments to the loads and pressures in the above table for lower speeds or stationary service.

NOTE: Minimum inflation pressures for IF agricultural tires used as singles = 12 psi.

**SECTION 1 –
INTRODUCTION**



TIRE LOAD LIMITS (KG) AT VARIOUS COLD INFLATION PRESSURES (BAR)											
		Inflation (bar)	.4	.6	.8	1.0	1.2	1.4	1.6	1.8	2.0
380/80R38	Goodyear		N/A	N/A	1750	1995	2240	2503	2721	2903	2993
IF320/80R42	Goodyear		N/A	N/A	1451	1651	1850	2059	2240	2358	2503
380/80R38	Alliance		N/A	N/A	N/A	N/A	N/A	N/A	2104	2222	2286
300/85R42	Mitas		N/A	N/A	N/A	N/A	N/A	N/A	1630	N/A	1790

TIRE LOAD LIMITS (KG) AT VARIOUS COLD INFLATION PRESSURES (BAR) (CONTINUED)											
		Inflation (bar)	2.4	2.8	3.2	3.6	4.0	4.4			
380/80R38	Goodyear		3243	3560	3742	4241	N/A	4626			
IF320/80R42	Goodyear		2649	2903	3152	N/A	N/A	N/A			
380/80R38	Alliance		2422	N/A	2880	3061	3243	N/A			
300/85R42	Mitas		1905	2090	2260	2410	2575	N/A			

NOTE: There are no adjustments to the loads and pressures in the above table for lower speeds or stationary service.

NOTE: Minimum inflation pressures for IF agricultural tires used as singles = .8 bar.

TORQUE VALUES

Unified Inch Bolt and Screw Torque Values



Bolt or Screw Size	SAE Grade 1				SAE Grade 2 ^a				SAE Grade 5, 5.1, or 5.2				SAE Grade 8 or 8.2			
	Lubricated ^b		Dry ^c		Lubricated ^b		Dry ^c		Lubricated ^b		Dry ^c		Lubricated ^b		Dry ^c	
	N-m	lb.-in.	N-m	lb.-in.	N-m	lb.-in.	N-m	lb.-in.	N-m	lb.-in.	N-m	lb.-in.	N-m	lb.-in.	N-m	lb.-in.
1/4	3.7	33	4.7	42	6	53	7.5	66	9.5	84	12	106	13.5	120	17	150
													N-m	lb.-ft.	N-m	lb.-ft.
5/16	7.7	68	9.8	86	12	106	15.5	137	19.5	172	25	221	28	20.5	35	26
									N-m	lb.-ft.	N-m	lb.-ft.				
3/8	13.5	120	17.5	155	22	194	27	240	35	26	44	32.5	49	36	63	46
			N-m	lb.-ft.	N-m	lb.-ft.	N-m	lb.-ft.								
7/16	22	194	28	20.5	35	26	44	32.5	56	41	70	52	80	59	100	74
	N-m	lb.-ft.														
1/2	34	25	42	31	53	39	67	49	85	63	110	80	120	88	155	115
9/16	48	35.5	60	45	76	56	95	70	125	92	155	115	175	130	220	165
5/8	67	49	85	63	105	77	135	100	170	125	215	160	240	175	305	225
3/4	120	88	150	110	190	140	240	175	300	220	380	280	425	315	540	400
7/8	190	140	240	175	190	140	240	175	490	360	615	455	690	510	870	640
1	285	210	360	265	285	210	360	265	730	540	920	680	1030	760	1300	960
1-1/8	400	300	510	375	400	300	510	375	910	670	1150	850	1450	1075	1850	1350
1-1/4	570	420	725	535	570	420	725	535	1280	945	1630	1200	2050	1500	2600	1920
1-3/8	750	550	950	700	750	550	950	700	1700	1250	2140	1580	2700	2000	3400	2500
1-1/2	990	730	1250	930	990	730	1250	930	2250	1650	2850	2100	3600	2650	4550	3350

Torque values listed are for general use only, based on the strength of the bolt or screw. **DO NOT** use these values if a different torque value or tightening procedure is given for a specific application. For plastic insert or crimped steel-type lock nuts, for stainless steel fasteners, or for nuts on U-bolts, see the tightening instructions for the specific application. Shear bolts are designed to fail under predetermined loads. Always replace shear bolts with identical grade.

Replace fasteners with the same or higher grade. If higher grade fasteners are used, tighten these to the strength of the original. Make sure fastener threads are clean and that you properly start thread engagement. When possible, lubricate plain or zinc plated fasteners other than lock nuts, wheel bolts or wheel nuts, unless different instructions are given for the specific application.

SECTION 1 – INTRODUCTION



^aGrade 2 applies for hex cap screws (not hex bolts) up to 6 in. (152 mm) long. Grade 1 applies for hex cap screws over 6 in. (152 mm) long, and for all other types of bolts and screws of any length.

^b“Lubricated” means coated with a lubricant such as engine oil, fasteners with phosphate and oil coatings, or 7/8 in. and larger fasteners with JDM F13C, F13F or F13J zinc flake coating.

^c“Dry” means plain or zinc plated without any lubrication, or 1/4 to 3/4 in. fasteners with JDM F13B, F13E or F13H zinc flake coating.

Metric Bolt and Screw Torque Values

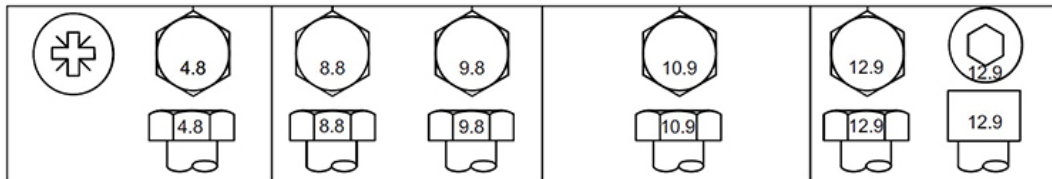

Bolt or Screw Size	Class 4.8				Class 8.8 or 9.8				Class 10.9				Class 12.9			
	Lubricated ^a		Dry ^b		Lubricated ^a		Dry ^b		Lubricated ^a		Dry ^b		Lubricated ^a		Dry ^b	
	N-m	lb.-in.	N-m	lb.-in.	N-m	lb.-in.	N-m	lb.-in.	N-m	lb.-in.	N-m	lb.-in.	N-m	lb.-in.	N-m	lb.-in.
M6	4.7	42	6	53	8.9	79	11.3	100	13	115	16.5	146	15.5	137	19.5	172
									N-m	lb.-ft.	N-m	lb.-ft.	N-m	lb.-ft.	N-m	lb.-ft.
M8	11.5	102	14.5	128	22	194	27.5	243	32	23.5	40	29.5	37	27.5	47	35
			N-m	lb.-ft.	N-m	lb.-ft.	N-m	lb.-ft.								
M10	23	204	29	21	43	32	55	40	63	46	80	59	75	55	95	70
	N-m	lb.-ft.														
M12	40	29.5	50	37	75	55	95	70	110	80	140	105	130	95	165	120
M14	63	46	80	59	120	88	150	110	175	130	220	165	205	150	260	190
M16	100	74	125	92	190	140	240	175	275	200	350	255	320	235	400	300
M18	135	100	170	125	265	195	330	245	375	275	475	350	440	325	560	410
M20	190	140	245	180	375	275	475	350	530	390	675	500	625	460	790	580
M22	265	195	330	245	510	375	650	480	725	535	920	680	850	625	1080	800
M24	330	245	425	315	650	480	820	600	920	680	1150	850	1080	800	1350	1000
M27	490	360	625	460	950	700	1200	885	1350	1000	1700	1250	1580	1160	2000	1475
M30	660	490	850	625	1290	950	1630	1200	1850	1350	2300	1700	2140	1580	2700	2000
M33	900	665	1150	850	1750	1300	2200	1625	2500	1850	3150	2325	2900	2150	3700	2730
M36	1150	850	1450	1075	2250	1650	2850	2100	3200	2350	4050	3000	3750	2770	4750	3500

Torque values listed are for general use only, based on the strength of the bolt or screw. DO NOT use these values if a different torque value or tightening procedure is given for a specific application. For stainless steel fasteners or for nuts on U-bolts, see the tightening instructions for

the specific application. Tighten plastic insert of crimped steel-type lock nuts by turning the nut to the dry torque shown in the chart, unless different instructions are given for the specific application.

Shear bolts are designed to fail under predetermined loads. Always replace shear bolts with identical property class. Replace fasteners with the same or higher property class. If higher property class fasteners are used, tighten these to the strength of the original. Make sure fastener threads are clean and that you properly start thread engagement. When possible, lubricate plain or zinc plated fasteners other than lock nuts, wheel bolts or wheel nuts, unless different instructions are given for the specific application.

^a“Lubricated” means coated with a lubricant such as engine oil, fasteners with phosphate and oil coatings, or M20 and larger fasteners with JDM F13C, F13F or F13J zinc flake coating.

^b“Dry” means plain or zinc plated without any lubrication, or M6 to M18 fasteners with JDM F13B, F13E or F13H zinc flake coating.

Face Seal Fittings Assembly and Installation - All Pressure Applications

Face Seal O-Ring to Stud End Installation

1. Inspect the fitting surfaces. They must be free of dirt and/or defects.
2. Inspect the O-ring. It must be free of damage and/or defects.
3. Lubricate O-rings using system oil, and install into groove.
4. Push O-ring into groove so O-ring is not displaced during assembly.
5. Index angle fittings and tighten by hand pressing joint together to insure O-ring remains in place.
6. Tighten fitting or nut to torque value shown on the chart per dash size stamped on the fitting. DO NOT allow hoses to twist when tightening fittings.

Face Seal Adjustable Stud End O-Ring Installation

1. Back off lock nut (jam nut) and washer to full exposed turned down section of the fitting.
2. Install a thimble over the fitting threads to protect the O-ring from nicks.
3. Slide the O-ring over the thimble into the turned down section of the fitting.
4. Remove thimble.

Face Seal Straight Stud End O-Ring Installation

1. Install a thimble over the fitting threads to protect the O-ring from nicks.
2. Slide the O-ring over the thimble into the turned down section of the fitting.
3. Remove thimble.

Fitting Installation

1. Install fitting by hand until snug.
2. Position adjustable fittings by unscrewing the fitting no more than one turn.
3. Apply assembly torque per table.

Assembly Torque

1. Use one wrench to hold the connector body and one wrench to tighten nut.
2. For a hydraulic hose, it may be necessary to use three wrenches to prevent twist; one on the connector body, one on the nut, and one on the body of the hose fitting.

SECTION 1 – INTRODUCTION



Metric Face Seal and O-Ring Stud End Fitting Torque Values

Standard Pressure Applications

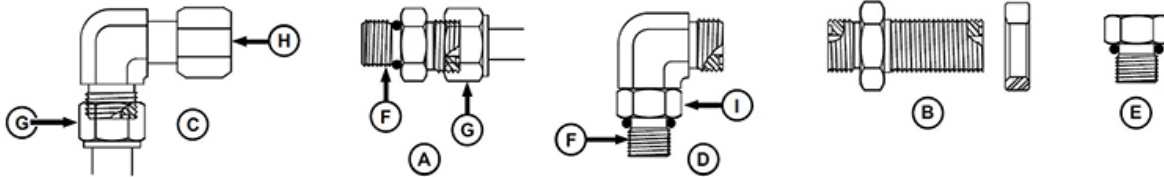

- A - Stud Straight and Tube Nut
- B - Bulkhead Union and Bulkhead Lock Nut
- C - 90° Swivel Elbow and Tube Nut
- D - 90° Adjustable Stud Elbow
- E - Port Plug
- F - Stud End
- G - Tube Nut
- H - Swivel Nut
- I - Lock Nut

Metric Face Seal and O-Ring Stud End Fitting Torque Chart - Standard Pressure (Below 27.6 MPA/4,000 PSI)

Nominal Tube OD Hose ID		O-Ring Face Seal/ Tube Swivel Nut						Bulkhead Jam Nut Torque ^A			O-Ring Straight, Adjustable, and External Port Plug Stud Ends ^A						
Metric Tube OD	Inch Tube OD			Thread Size	Swivel Nut Hex Size	Tube Nut/ Swivel Nut Torque		Jam Nut Hex Size	Jam Nut Torque		Thread Size	Straight Hex Size ^B	Adj Lock Nut Hex Size	Steel or Gray Iron Torque		Aluminum or Brass Torque ^C	
mm	Dash Size	in.	mm	in.	mm	N·m	lb.-ft.	mm	N·m	lb.-ft.	mm	mm	mm	N·m	lb.-ft.		
N·m	lb.-ft.																
4	-2	0.1 -25	3.18	---	---	---	---	---	---	---	M8x1	12	12	8	6	5	4
5	-3	0.1 -88	4.76	---	---	---	---	---	---	---	M10x1	14	14	15	11	10	7
6	-4	0.2 -50	6.35	9/16- 18	17	24	18	22	32	24	M12x1.5	17	17	25	18	17	12
8	-5	0.3 -12	7.92	---	---	---	---	---	---	---	M14x1.5	19	19	40	30	27	20
10	-6	0.3 -75	9.53	11/16- 16	22	37	27	27	42	31	M16x1.5	22	22	45	33	30	22
12	-8	0.5 -00	12.7- 0	13/16- 16	24	50	37	30	93	69	M18x1.5	24	24	50	37	33	25

16	-10	0.6 -25	15.8- 8	1-14	30	69	51	36	118	87	M22x1.5	27	27	69	51	46	34
20	-12	0.7 -50	19.0- 5	1-3/16- 12	36	102	75	41	175	129	M27x2	32	32	10- 0	74	67	49
22	-14	0.8 -75	22.2- 3	1-3/16- 12	36	102	75	41	175	129	M30x2	36	36	13- 0	96	87	64
25	-16	1.0 -00	25.4- 0	1-7/16- 12	41	142	105	46	247	182	M33x2	41	41	16- 0	118	1- 07	79
28	---	---	---	---	---	---	---	---	---	---	M38x2	46	46	17- 6	130	1- 17	87
32	-20	1.2 -50	31.7- 5	1-11/ 16-12	50	190	140	50	328	242	M42x2	50	50	21- 0	155	1- 40	1- 03
38	-24	1.5 -00	38.1- 0	2-12	60	217	160	60	374	276	M48x2	55	55	26- 0	192	1- 73	1- 28
50	-32	2.0 -00	50.8- 0	---	---	---	---	---	---	---	M60x2	65	65	31- 5	232	2- 10	1- 55

A Tolerance is +15%, minus 20% of mean tightening torque unless otherwise specified.

B The straight hex wrench sizes listed apply to connectors only and may not be the same as the corresponding plug of the same thread size.

C These torques were established using steel plated connectors in aluminum and brass.

Metric Face Seal and O-Ring Stud End Fitting Torque Values

High Pressure Applications

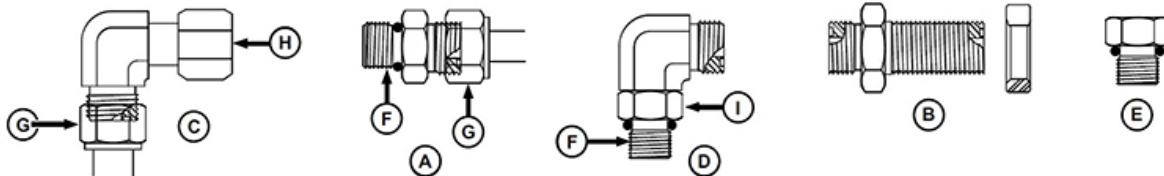

- A - Stud Straight and Tube Nut
- B - Bulkhead Union and Bulkhead Lock Nut
- C - 90° Swivel Elbow and Tube Nut
- D - 90° Adjustable Stud Elbow
- E - Port Plug

- F - Stud End
- G - Tube Nut
- H - Swivel Nut
- I - Lock Nut

SECTION 1 – INTRODUCTION



Metric Face Seal and O-Ring Stud End Fitting Torque Chart High Pressure (Above 27.6 MPA/4,000 PSI), Working Pressure (41.3 MPA/6,000 PSI)															
Nominal Tube OD Hose ID				O-Ring Face Seal/ Tube Swivel Nut				Bulkhead Jam Nut Torque ^A			O-Ring Straight, Adjustable, and External Port Plug Stud Ends ^A				
Metric Tube OD	Inch Tube OD			Thread Size	Swivel Nut Hex Size	Tube Nut/ Swivel Nut Torque		Jam Nut Hex Size	Jam Nut Torque		Thread Size	Straight Hex Size ^B	Adj Lock Nut Hex Size	Steel or Gray Iron Torque	
	mm	Dash Size	in.			mm	in.		mm	N-m				lb.-ft.	mm
4	-2	0.12-5	3.18	---	---	---	---	---	---	---	M8x1	12	12	8	6
5	-3	0.18-8	4.76	---	---	---	---	---	---	---	M10x1	14	14	15	11
6	-4	0.25-0	6.35	9/16-18	17	24	18	22	32	24	M12x1.5	17	17	35	26
8	-5	0.31-2	7.92	---	---	---	---	---	---	---	M14x1.5	19	19	45	33
10	-6	0.37-5	9.53	11/16-16	22	37	27	27	42	31	M16x1.5	22	22	55	41
12	-8	0.50-0	12.70	13/16-16	24	63	46	30	93	69	M18x1.5	24	24	70	52
16	-10	0.62-5	15.88	1-14	30	103	76	36	118	87	M22x1.5	27	27	100	74
20	-12	0.75-0	19.05	1-3/16-12	36	152	112	41	175	129	M27x2	32	32	170	125
22	-14	0.87-5	22.23	1-3/16-12	36	152	112	41	175	129	M30x2	36	36	215	159
25	-16	1.00-0	25.40	1-7/16-12	41	214	158	46	247	182	M33x2	41	41	260	192
28	---	---	---	---	---	---	---	---	---	---	M38x2	46	46	320	236
32	-20	1.25-0	31.75	1-11/16-12	50	286	211	50	328	242	M42x2	50	50	360	266
38	-24	1.50-0	38.10	2-12	60	326	240	60	374	276	M48x2	55	55	420	310

^ATolerance is +15%, minus 20% of mean tightening torque unless otherwise specified.

^BThe straight hex wrench sizes listed apply to connectors only and may not be the same as the corresponding plug of the same thread size.

SAE Face Seal and O-Ring Stud End Fitting Torque Values

Standard Pressure Applications

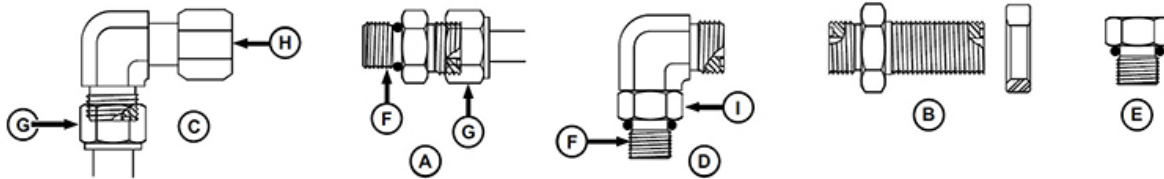

- A - Stud Straight and Tube Nut
- B - Bulkhead Union and Bulkhead Lock Nut
- C - 90° Swivel Elbow and Tube Nut
- D - 90° Adjustable Stud Elbow
- E - Port Plug
- F - Stud End
- G - Tube Nut
- H - Swivel Nut
- I - Lock Nut

SAE Face Seal and O-Ring Stud End Fitting Torque Chart - Standard Pressure (Below 27.6 MPA/4,000 PSI)

Nominal Tube OD Hose ID				O-Ring Face Seal/ Tube Swivel Nut				Bulkhead Jam Nut Torque ^A				O-Ring Straight, Adjustable, and External Port Plug Stud Ends ^A					
												Thread Size	Swivel Nut Hex Size	Tube Nut/ Swivel Nut Torque	Jam Nut Hex Size	Jam Nut Torque	Thread Size
Metric Tube OD	Inch Tube OD			in.	in.	N-m	lb.-ft.	in.	in.	N-m	lb.-ft.	in.	in.	in.	in.		
mm	Dash Size	in.	mm	in.	in.	N-m	lb.-ft.	in.	in.	N-m	lb.-ft.	in.	in.	in.	in.		
N-m	lb.-ft.	N-m	lb.-ft.														
5	-3	0.188	4.78	---	---	---	---	---	---	---	3/8-24	5/8	9/16	12	9	8	6
6	-4	0.250	6.35	9/16-18	11/16	24	18	13/16	32	24	7/16-20	5/8	5/8	16	1-2	11	8
8	-5	0.312	7.92	---	---	---	---	---	---	---	1/2-20	3/4	11/16	24	1-8	16	1-2
10	-6	0.375	9.53	11/16-16	13/16	37	27	1	42	31	9/16-18	3/4	3/4	37	2-7	25	1-8
12	-8	0.500	12.70	13/16-16	15/16	50	37	1-1/8	93	69	3/4-16	7/8	15/16	50	3-7	33	2-5
16	-10	0.625	15.88	1-14	1-1/8	69	51	1-5/16	1-18	87	7/8-14	1-1/16	1-1/16	69	5-1	46	3-4
20	-12	0.750	19.05	1-3/16-12	1-3/8	1-02	75	1-1/2	1-75	1-29	1-1/16-12	1-1/4	1-3/8	10-2	7-5	68	5-0
22	-14	0.875	22.23	1-3/16-12	---	1-02	75	---	1-75	1-29	1-3/16-12	1-3/8	1-1/2	12-2	9-0	81	6-0
25	-16	1.000	25.40	1-7/16-12	1-5/8	1-42	10-5	1-3/4	2-47	1-82	1-5/16-12	1-1/2	1-5/8	14-2	1-0-5	95	7-0
32	-20	1.25	31.75	1-11/16-12	1-7/8	1-90	14-0	2	3-28	2-42	1-5/8-12	1-3/4	1-7/8	19-0	1-4-0	1-27	9-3
38	-24	1.50	38.10	2-12	2-1/4	2-17	16-0	2-3/8	3-74	2-76	1-7/8-12	2-1/8	2-1/8	21-7	1-6-0	1-45	1-0-7
50.8	-32	2.000	50.80	---	---	---	---	---	---	---	2-1/2-12	2-3/4	2-3/4	31-1	2-2-9	2-07	1-5-3

^ATolerance is +15%, minus 20% of mean tightening torque unless otherwise specified.

SECTION 1 – INTRODUCTION



^BThe straight hex wrench sizes listed apply to connectors only and may not be the same as the corresponding plug of the same thread size.

^CThese torques were established using steel plated connectors in aluminum and brass.

SAE Face Seal and O-Ring Stud End Fitting Torque Values

High Pressure Applications

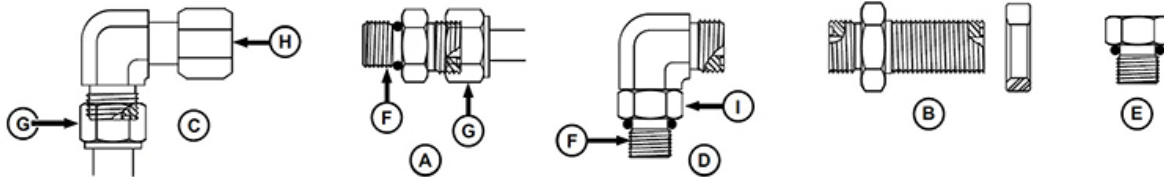

- A - Stud Straight and Tube Nut
- B - Bulkhead Union and Bulkhead Lock Nut
- C - 90° Swivel Elbow and Tube Nut
- D - 90° Adjustable Stud Elbow
- E - Port Plug
- F - Stud End
- G - Tube Nut
- H - Swivel Nut
- I - Lock Nut

SAE Face Seal and O-Ring Stud End Fitting Torque Chart High Pressure (Above 27.6 MPA/4,000 PSI), Working Pressure (41.3 MPA/6,000 PSI)															
Nominal Tube OD Hose ID				O-Ring Face Seal/ Tube Swivel Nut				Bulkhead Jam Nut Torque ^A				O-Ring Straight, Adjustable, and External Port Plug Stud Ends ^A			
Metric Tube OD	Inch Tube OD			Thread Size	Swivel Nut Hex Size	Tube Nut/ Swivel Nut Torque		Jam Nut Hex Size	Jam Nut Torque		Thread Size	Straight Hex Size ^B	Adj Lock Nut Hex Size	Steel or Gray Iron Torque	
	mm	Dash Size	in.			mm	in.		N-m	lb.-ft.				N-m	lb.-ft.
5	-3	0.18-8	4.78	---	---	---	---	---	---	---	3/8-24	5/8	9/16	18	13
6	-4	0.25-0	6.35	9/16-18	11/16	24	18	13/16	32	24	7/16-20	5/8	5/8	24	18
8	-5	0.31-2	7.92	---	---	---	---	---	---	---	1/2-20	3/4	11/16	30	22
10	-6	0.37-5	9.53	11/16-16	13/16	37	27	1	42	31	9/16-18	3/4	3/4	37	27
12	-8	0.50-0	12.70	13/16-16	15/16	63	46	1-1/8	93	69	3/4-16	7/8	15/16	75	55
16	-10	0.62-5	15.88	1-14	1-1/8	103	76	1-5/16	118	87	7/8-14	1-1/16	1-1/16	103	76
20	-12	0.75-0	19.05	1-3/16-12	1-3/8	152	112	1-1/2	175	129	1-1/16-12	1-1/4	1-3/8	177	131
22	-14	0.87-5	22.23	1-3/16-12	---	152	112	---	175	129	1-3/16-12	1-3/8	1-1/2	231	170
25	-16	1.00-0	25.40	1-7/16-12	1-5/8	214	158	1-3/4	247	182	1-5/16-12	1-1/2	1-5/8	270	199
32	-20	1.25	31.75	1-11/16-12	1-7/8	286	211	2	328	242	1-5/8-12	1-3/4	1-7/8	286	211
38	-24	1.50	38.10	2-12	2-1/4	326	240	2-3/8	374	276	1-7/8-12	2-1/8	2-1/8	326	240

^ATolerance is +15%, minus 20% of mean tightening torque unless otherwise specified.

^BThe straight hex wrench sizes listed apply to connectors only and may not be the same as the corresponding plug of the same thread size.

**Four Bolt Flange Fittings
Assembly and Installation - All
Pressure Applications**

1. Inspect the sealing surfaces for nicks or scratches, roughness or out-of-flat condition. Scratches cause leaks. Roughness causes seal wear. Out-of-flat causes seal extrusion. If these defects cannot be polished out, replace the component.
2. Install the correct O-ring (and backup washer if required) into the groove using petroleum jelly to hold it in place.
3. For split flange; loosely assemble split flange halves, being sure that the split is centrally located and perpendicular to the port. Hand-tighten cap screws to hold parts in place. Do not pinch O-ring.
4. For single piece flange; put hydraulic line in the center of the flange and install four cap screws. With the flange centrally located on the port, hand-tighten cap screws to hold it in place. Do not pinch O-ring.
5. For both single piece flange and split flange, be sure the components are properly positioned and cap screws are hand tight. Tighten one cap screw, then tighten the diagonally opposite cap screw. Tighten the two remaining cap screws. Tighten all cap screws within the specified limits shown in the chart. **DO NOT** use air wrenches. **DO NOT** tighten one cap screw fully before tightening the others. **DO NOT** over-tighten.

SAE Four Bolt Flange Cap Screw Torque Values

Standard Pressure Applications

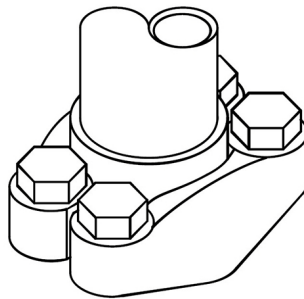

SAE Four Bolt Flange Cap Screw Torque Values - 27,600 KPA (4,000 PSI) Pressure Applications					
		Torque			
		Newton Meters		Foot Pounds	
Nominal Flange Size	Screw Size ^{ab}	Min	Max	Min	Max
1/2	5/16-18 UNC	20	31	15	23
3/4	3/8-16 UNC	28	54	21	40
1	3/8-16 UNC	37	54	27	40

**SECTION 1 –
INTRODUCTION**



1-1/4	7/16-14 UNC	47	85	35	63
1-1/2	1/2-13 UNC	62	131	46	97
2	1/2-13 UNC	73	131	54	97
2-1/2	1/2-13 UNC	107	131	79	97
3	5/8-11 UNC	187	264	138	195
3-1/2	5/8-11 UNC	158	264	117	195
4	5/8-11 UNC	158	264	117	195
5	5/8-11 UNC	158	264	117	195

^aJDM A17D, SAE Grade 5 or better cap screws with plated hardware.

^b1.5.1.2 Lock washers are permissible but not recommended.

SAE Four Bolt Flange Cap Screw Torque Values

High Pressure Applications

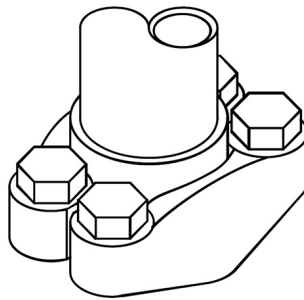

SAE Four Bolt Flange Cap Screw Torque Values - 41,400 KPA (6,000 PSI) Pressure Applications					
		Torque			
		Newton Meters		Foot Pounds	
Nominal Flange Size	Screw Size ^{ab}	Min	Max	Min	Max
1/2	5/16-18 UNC	20	31	15	23
3/4	3/8-16 UNC	34	54	25	40
1	7/16-14 UNC	57	85	42	63
1-1/4	1/2-13 UNC	85	131	63	63
1-1/2	5/8-11 UNC	159	264	117	195
2	3/4-10 UNC	271	468	200	345

^aJDM A17D, SAE Grade 5 or better cap screws with plated hardware.

^b1.5.1.2 Lock washers are permissible but not recommended.

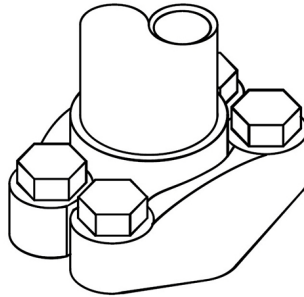
External Hexagon Port Plug Torque Values

Port or Stud End Thread Size ^a	Torque (+15%/-20%)
M8 x 1	10 N·m (89 lb.-in.)
M10 x 1	17 N·m (150 lb.-in.)
M12 x 1.5	28 N·m (20.6 lb.-in.)
M14 x 1.5	39 N·m (28.7 lb.-in.)
M16 x 1.5	48 N·m (35.4 lb.-in.)
M18 x 1.5	60 N·m (44.2 lb.-in.)
M20 x 1.5	60 N·m (44.2 lb.-in.)
M22 x 1.5	85 N·m (62.7 lb.-in.)
M27 x 2	135 N·m (99.6 lb.-in.)
M30 x 2	165 N·m (121.7 lb.-in.)
M33 x 2	235 N·m (173.3 lb.-in.)
M38 x 2	245 N·m (180.7 lb.-in.)
M42 x 2	260 N·m (191.8 lb.-in.)
M48 x 2	290 N·m (213.9 lb.-in.)
M60 x 2	330 N·m (243.4 lb.-in.)

^aPort to JDS-G173.1; stud end to JDS-G173.3.



SECTION 2 – SAFETY AND PRECAUTIONS

INTENDED USE

NOTICE

This machine is designed for and intended to be used for the removal of tassels from the tops of corn plants. Use in any other way or for any other purpose is considered misuse of this machine.

Most accidents occur as the result of failure to follow basic and fundamental safety rules and precautions. Recognizing potential safety hazards, following correct and safe operating procedures described in this manual, and complying with safety warnings located throughout the machine may reduce the risk of accidents.

There is no way to completely eliminate the potential for danger when operating agricultural equipment. Therefore, you must study this operator's manual and understand how to operate the detasseler controls for safe operation before using the detasseler, its attachments, or any detasseling equipment. Likewise, never let anyone operate the machine without proper instruction.

Do not operate the detasseler, its attachments, or any detasseling equipment for anything other than their intended uses. Hagie Manufacturing Company shall not be liable for any damage, injury, or death associated with improper use of the detasseler, its attachments, or any detasseling equipment.

Do not make any modifications such as, but not limited to, weldments, add-ons, adaptations, or changes from the original design of the machine. Such modifications may become safety hazards to you and others and **will void all warranties**.

Replace missing, faded, or damaged safety signs. Refer to "Safety Decals" elsewhere in this section for correct sign and placement.

SAFETY PRECAUTIONS

NOTE: If your machine is equipped with All Wheel Steer (AWS), pay special attention to components, operating instructions, and safety precautions marked with ^.

Do Not Bypass Safety Start

- Start the machine from the operator's seat only.
- The machine must be in NEUTRAL and the parking brake must be engaged before starting the engine.



Use Caution While Driving ^

- Never drive near ditches, embankments, holes, mounds, or other obstacles.
- Never drive on hills too steep for safe operation.

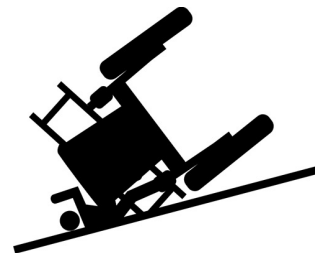

- Reduce machine speed before turning.



- Do not permit passengers to ride on the machine while it is moving. Failure to comply may result in passenger falling off of machine and/or obstructing the operator's view.
- Keep riders off machine. The only time a passenger should be permitted to ride inside the cab is for instructional or diagnostic purposes only. The passenger should be seated in the instructor seat next to the operator and never allowed to ride outside of the cab.



- Ensure there is adequate clearance before driving under any overhead obstructions. Contact with power lines may result in serious injury or death.
- Outriggers must be folded when driving the machine on a roadway or when near power lines.

Remove Paint Before Welding or Heating

- Avoid toxic fumes and dust. Hazardous fumes can be generated when paint is heated by welding, soldering, or using a torch.



- Do not use chlorinated solvents in areas where welding will take place.
- Perform all work in an area that is well ventilated to carry toxic fumes and dust away.
- Dispose of paint and solvents properly.

Avoid Heating Near Pressurized Lines

- Avoid torching, welding, and soldering near pressurized hydraulic lines. Pressurized lines may accidentally burst when heat goes beyond the immediate flame area.



Handle Fuel Safely

- Always turn the engine off and allow it to cool before refueling.
- NEVER smoke while refueling.



- Do not fill tank completely, as fuel may expand and run over.
- Always clean up spilled fuel with soapy water.
- Keep a fire extinguisher nearby when refueling.

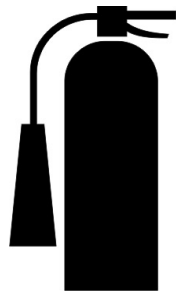

Operate Safely ^

- Before moving the machine, ensure there are no obstacles or persons in the path of travel.
- Never operate a machine in the same field as walking personnel.
- Always drive at a reasonable field speed.
- Ensure the Slow Moving Vehicle (SMV) emblem and the Speed Indicator Symbol (SIS) are in place and visible from the rear of machine when traveling on public roadways.



SMV



SIS (mph)



SIS (km/h)

- Pull over to the side of the road before stopping.
- Always come to a complete stop before reversing directions.
- Ensure the back-up alarm is audible when operating the machine in reverse.
- Keep a fire extinguisher nearby at all times.
- Keep ALL shields in place.
- Keep clear of all moving parts and keep others away while operating (including the reversible fan).
- Do not activate the parking brake while the machine is in motion.
- Bring machine to a gradual stop to avoid sudden downward decent.
- Reduce speed for icy, wet, graveled, or soft roadway surfaces.
- Use flashers/hazard warning lights (day or night) unless prohibited by law.
- Keep away from overhead power lines. Serious injury or death may result to you or others should the machine come into contact with electrical power lines.
- Never use starting fluid to assist engine start-up.
- If your machine is equipped with ground speed sensing radar or light sensing depth units, do NOT look directly into radar beam, as it emits a very low intensity microwave signal, which may result in possible eye damage.

Be Prepared

- Be prepared for an emergency. Keep a fire extinguisher, first aid kit, and clean water in the cab at all times.
- Service the fire extinguisher regularly.
- Keep an accurate inventory of supplies in the first aid kit and dispose of any item(s) that have expired.

Wear Protective Clothing

- Do not wear loose fitting clothing that could get caught in moving parts. Wear safety equipment that is appropriate for the job.



- Do not store chemical-soaked clothing in the cab. Clean off as much mud and dirt from your shoes as you can before entering the cab.

Protect Against Noise

- Wear suitable hearing protection. Prolonged exposure to loud noise may result in loss of hearing.



Battery Acid Accident Prevention

WARNING: Battery posts, terminals, and related accessories contain lead and lead compounds, chemicals known to the State of California to cause cancer and reproductive harm. Wash hands after handling.

Avoid serious injury by avoiding battery acid contact with your body. Battery electrolyte contains sulfuric acid that is strong enough to eat holes in clothing and cause blindness if splashed into eyes.

Make sure to:

- Fill batteries in a well ventilated area.
- Wear Personal Protective Equipment (PPE) when servicing a battery.
- Avoid inhaling of fumes when recharging with electrolyte.
- Avoid spilling or dripping electrolyte.
- When charging a battery, connect positive cable to positive terminal and negative cable to negative terminal. Failure to comply may result in an explosion and/or personal injury.

If you spill on yourself:

- Flush affected area with cold water and remove contaminated clothing immediately. Continue to flush the area for a minimum of 15 minutes.



- Call a physician.
- While transporting or waiting for medical attention, apply compresses of iced water or immerse affected area in iced water. **DO NOT ALLOW SKIN TISSUE TO FREEZE.**
- Do not apply creams or ointments until you have been seen by a physician.

If acid is swallowed:

- Do NOT induce vomiting.
- Drink large amounts of water.
- Seek medical attention immediately!

SECTION 2 – SAFETY AND PRECAUTIONS



- Do not neutralize the acid.

If fumes are inhaled:

- Move the person into fresh air.
- Do not give artificial respiration to a person that is able to breathe on their own.
- Give CPR only if there is no breathing and no pulse.
- Seek medical attention immediately!

Safe Hydraulic Maintenance

- Always practice personal safety when performing service or maintenance on the hydraulic system.
- Use caution when working around hydraulic fluid under pressure. Escaping fluid can have sufficient force to penetrate your skin, possibly resulting in serious injury. This fluid may also be hot enough to burn.

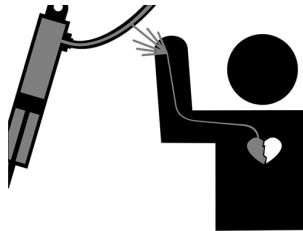

- Always lower the load or relieve the pressure before repairing a hydraulic oil leak.

Beware of Exhaust Fumes

- Never run the machine in an enclosed area. Proper ventilation is required. Use an exhaust pipe extension to remove fumes if you must operate inside a building. Also, open doors and windows to bring in enough outside air into the area.

General Maintenance Safety

- Turn off engine before checking, adjusting, repairing, lubricating, or cleaning any part of the sprayer.
- When servicing the radiator, allow engine to cool before removing the pressurized cap.



- Disconnect battery ground cable and turn the Battery Disconnect Switch OFF before servicing the electrical system or welding on the machine.



- Machines equipped with All Wheel Steer (AWS) have position sensing internal to the steering cylinders. Disconnect each sensor before welding on the machine. ^
- Never pressurize suspension air bags over 100 psi (6.9 bar).

Remove Accumulated Crop Debris

- The buildup of crop debris in the engine compartment, on the engine, or near moving parts is a fire hazard. Check and clean areas frequently. Before performing any inspection or service, engage the parking brake, shut off the engine, and remove the key.



Tread Adjust

- Transport machine at narrowest tread adjust setting only.

All Wheel Steer (AWS) Safety ^

–If Equipped

Many of the following precautions are repetitious to the precautions for a standard machine. It is imperative they receive special consideration. Failure to comply with the AWS safety precautions and operating instructions may result in property damage, serious injury, or death.

- Become familiar with and understand how to operate your machine in conventional steering mode before operating with AWS.
- Understand AWS system components, operating procedures, and system limitations before operating.
- Reduce machine speed before turning.
- Never drive on hills too steep for safe operation.
- Never drive near ditches, embankments, holes, mounds, or other obstacles.
- Come to a complete stop before reversing directions.
- Always drive at a reasonable field speed.

OPERATOR PRESENCE SWITCH (OPS)

The Operator Presence Switch (located inside the operator's seat) protects the operator from exposure to moving parts or hazards when operating the detasseler cutter heads and quad pullers.

This safety feature introduces an electrical interlock that ensures that when the operator is out of the cab, the operation of these functions have stopped. This is achieved by using the OPS to prevent the detasseler assemblies from operating if the operator is not seated in the operator's seat for three (3) seconds.

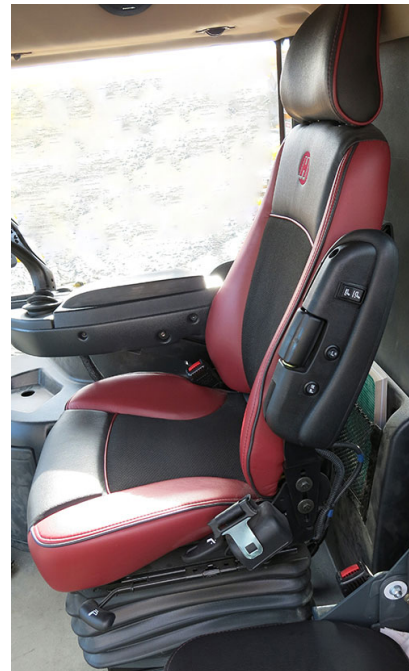

Operator Presence Switch
(Located inside the operator's seat)
-Typical View

NOTE: When the operator leaves the operator's seat while the machine is running, a warning message will appear on the Machine Display to alert the operator to operate the machine from seat. Press OK to acknowledge.

SEAT BELT

For your safety, wear seat belt at all times when operating the machine.

Seat Belt Operation

- Grasp the Seat Belt Buckle (located on the outward side of seat) and extend all the way across your hips, seated below your abdomen.
- Insert the buckle tongue into the receptacle assembly (located on the opposite side of seat) and engage into LOCKED position.
- **To release Seat Belt**, press the Release Button (located on the receptacle end) and allow belt to retract.

Inspection/Replacement

Inspect seat belt and mounting hardware yearly. Replace seat belt if anchorage system, buckle, belt, or retractor shows signs of damage, including evidence of cuts, fraying or wear, discoloration, or being heavily soiled - especially with oil grease or fuel. Replace only with replacement parts approved for your machine.

ROTATING BEACON

The Rotating Beacon (located on the front roof cap) is used for increased visibility to others. The beacon will illuminate when the Hazard/Warning Lights Switch (located on the steering column) is activated.

NOTE: The Rotating Beacon is active in both Road and Field mode. The Hazard/Warning Lights are active in Road mode only.



Rotating Beacon
(Located on front roof cap)
-Typical View

EMERGENCY STOP

(E-Stop)

NOTICE

Do not use the E-Stop Switch for non-emergency stopping or as a parking brake.

The E-Stop Switch (located on the side console) provides a quick and positive method for stopping the engine in an emergency situation.

When the E-Stop Switch is depressed, it locks in position and removes the ignition signal to shut down the engine. To reset the E-Stop Switch, turn the switch in the direction of the arrows (located on the face of the button).



E-Stop Switch
(Located on the side console)
-Typical View

When the E-Stop Switch is activated, a warning message will appear on the Machine Display to alert the operator that the E-Stop is engaged. Press OK to acknowledge.

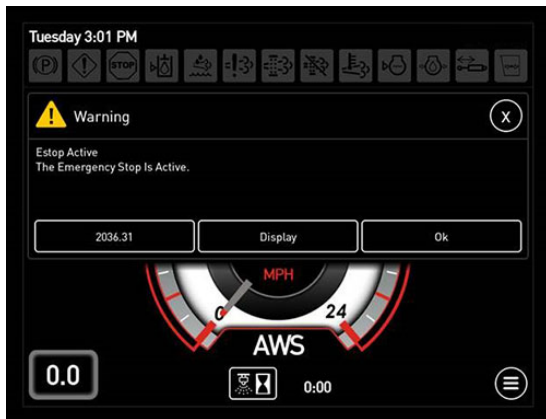

E-Stop Active Warning Message
(Located on the Machine Display)

EMERGENCY EXIT

CAUTION

Do not look directly at the glass when using the Emergency Exit Tool. Failure to comply may result in personal injury.

NOTICE

The Emergency Exit Tool is a permanent fixture of the machine. Do not remove from cab under any circumstances.

In the event of an emergency, use the cab door to exit the machine. Should the cab door become inoperable, an Emergency Exit Tool (located along the rear right-hand side of cab) is provided and is used in the rare event to shatter the glass of the cab.

- Using the metal end of the Emergency Exit Tool, repeatedly strike the glass to shatter.



Emergency Exit Tool
(Located along rear right-hand side of cab)
-Typical View

Should the need arise to escape from a seat belt that may become inoperable, use the “hook end” of the Emergency Exit Tool to cut the seat belt.

SECTION 2 – SAFETY AND PRECAUTIONS



FIRE EXTINGUISHER

Your machine is equipped with a Fire Extinguisher (located behind the left-hand side of cab). In the event that use of the Fire Extinguisher is required, follow the manufacturer's operating instructions provided on the Fire Extinguisher.

To Remove Fire Extinguisher

- Pull the Security Latch OUTWARD to disengage and remove Fire Extinguisher.



Fire Extinguisher
(Located behind left-hand side of cab)
-Typical View

Inspection and Replacement

Follow the manufacturer's recommendations on inspection and replacement.

SAFETY DECALS

Decals warning you of avoidable danger are located on various parts of the machine and attachment. They are there for your personal safety and protection. DO NOT

remove them. They will fracture upon attempted removal and therefore, must be replaced.

Following are locations of important safety decals. Replace them if they are damaged or missing. All safety decals, instructional decals, or machine striping may be purchased through your local John Deere dealer.

To replace safety decals, ensure the installation area is clean and dry and decide on exact position before you remove the backing paper.

Safety Decal Locations

650258

(Located on each side of cutter head assemblies)



CAUTION

SEVERING OF FINGERS OR HAND.
DO NOT PLACE FINGERS OR
HAND NEAR A MOVING CUTTER
BLADE, ATTEMPT TO STOP A MOVING CUTTER
BLADE, OR PERFORM MAINTENANCE
NEAR A MOVING CUTTER BLADE.

650259
(Located on mounting tube of each quad puller head assembly)



CAUTION

RISK OF INJURY FROM ROTATING TIRES. DO NOT PLACE FINGERS OR HAND NEAR MOVING QUAD PULLER TIRES, DISLodge A WEDGED OBJECT FROM MOVING TIRES, OR PERFORM MAINTENANCE NEAR MOVING TIRES.

650303
(Located on right-hand cab window)

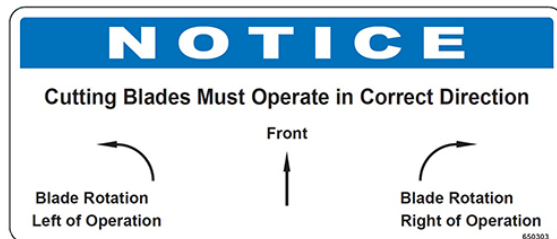

650379
(Located on right-hand cab window)

*** TO ENGAGE DETASSELING HEAD HYD MTRS:**

1. Reduce engine speed to an idle.
2. Clear area of unauthorized personnel.
3. Turn individual motor control switches to "ON".
4. Slowly increase engine RPM to desired speed.

650379

650364
(4) - Located on each air bag



N403721
(Located on inner right-hand side of ladder)



**SECTION 2 –
SAFETY AND PRECAUTIONS**



650584
(Located near radiator cap)

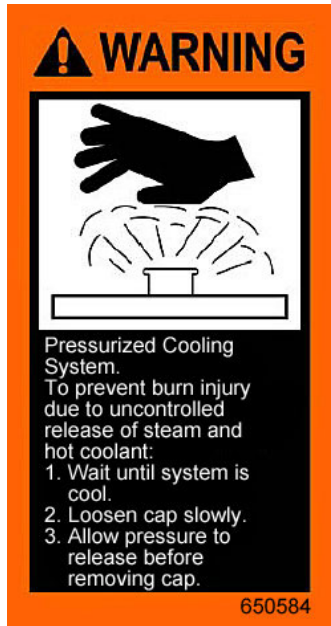

650518
(Located near battery disconnect switch)

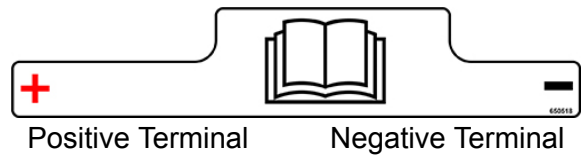

650493
(Located near hydraulic oil reservoir sight gauge)

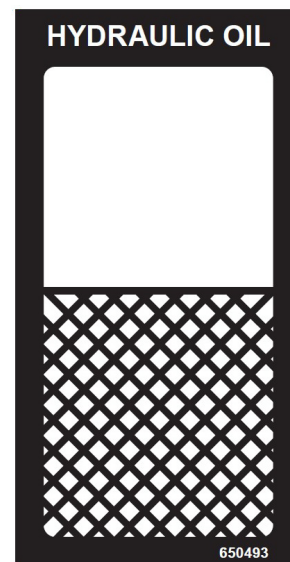

HYDRAULIC OIL RESERVOIR LEVEL

L212136
(4) - Located near each lifting point containment ring

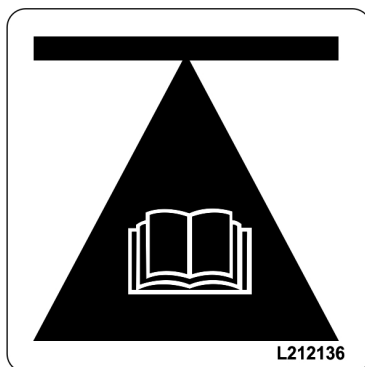

RISK OF INJURY DUE TO IMPROPER LIFTING.
DO NOT ATTEMPT TO LIFT MACHINE
WITHOUT JACKS PROPERLY SEATED IN THE
LIFTING POINT CONTAINMENT RINGS.

HXE28534
(Located on back side of center tool bar)

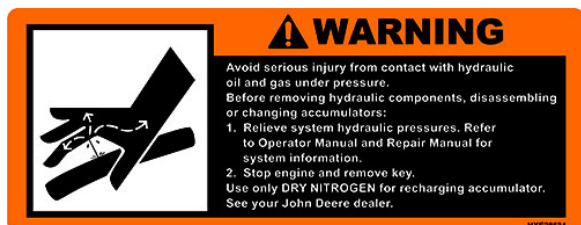

650637

(Located on front bulk head beneath left-hand side of cab)



650431

(Located near fuel fill - Final Tier 4 engines only)



T188283

(Located near fan)



HXE19558

(Located on inner right-hand side of ladder)



650504

(Located beneath front end cap)



CAUTION

CRUSH HAZARD.
RISK OF INJURY DUE TO IMPROPER OPERATION. REFER TO OPERATOR'S MANUAL FOR INSTRUCTION.



SECTION 3 – CAB

SEAT - OPERATOR (STANDARD)

NOTE: Refer to the seat manufacturer's operating instructions provided on the back side of the operator's seat for further information, including safety precautions and maintenance of seat.

Seat Functions and Operation

- (1) - Weight Adjustment
- (2) - Height Adjustment
- (3) - Fore/Aft Isolator
- (4) - Fore/Aft Adjustment
- (5) - Armrest Adjustment
- (6) - Backrest Extension
- (7) - Lumbar Support
- (8) - Backrest Adjustment
- (9) - Swivel

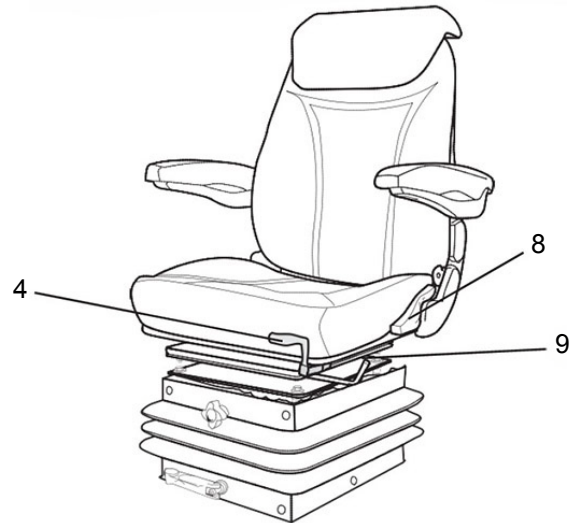
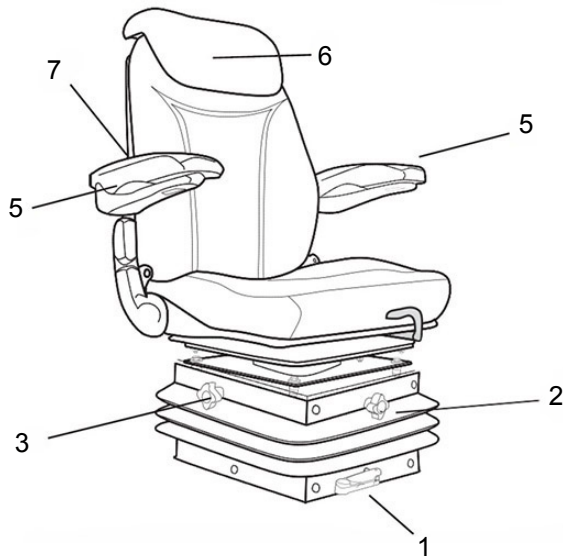

Weight Adjustment (1)

The seat must be adjusted for the driver's weight by briefly pulling the actuator switch of the weight adjuster with the machine at a standstill and the driver sitting in the seat.

NOTE: The operator must remain still during adjustment.

NOTE: To prevent health damage, the setting for the driver's weight must be checked and adjusted individually before operating the machine.

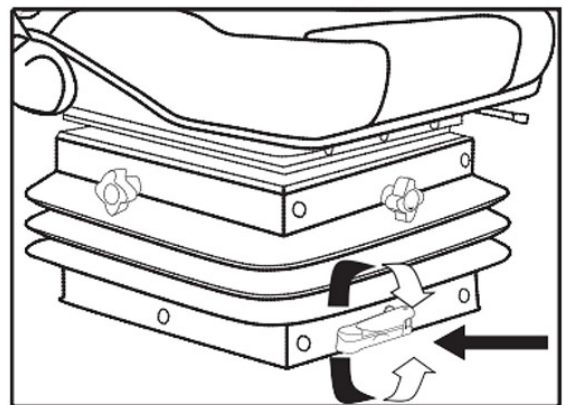

Height Adjustment (2)

Seat height can be adjusted by pulling or pushing the adjustment lever to lower the seat counter-clockwise, or raise the seat clockwise.

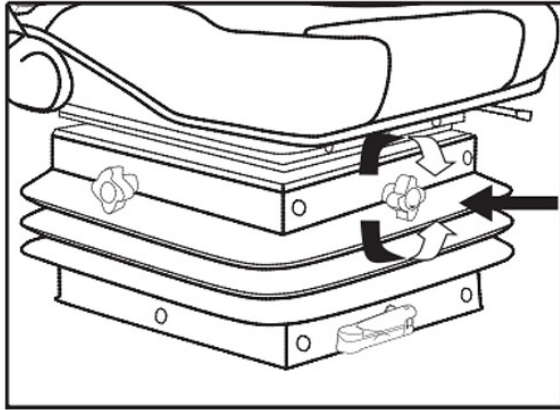

Fore/Aft Isolator (3)

Under certain conditions (for example, with a trailer attached), it is useful to activate the fore/aft isolator. This means that shock impacts in the driving direction can be better absorbed by the operator's seat.

- Position 1 = Fore/Aft Isolator OFF
- Position 2 = Fore/Aft Isolator ON

After the adjustment of Position 1, the locking lever must latch into desired position. For that, the seat must be pressed backwards until it latches with an audible click.

NOTE: It is impossible to move the fore/aft isolator into another position when locked.

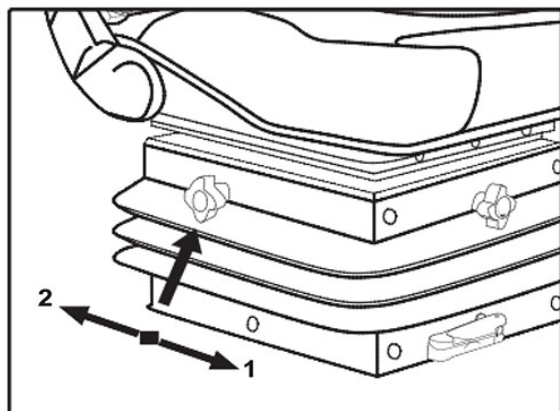

Fore/Aft Adjustment (4)

⚠ WARNING

Risk of Accident!

Do not operate the locking lever while driving the machine.

The fore/aft adjustment is released by lifting outside the locking lever (left). After the adjustment, the locking lever must latch into the desired position with an audible click.

NOTE: It is impossible to move the operator's seat to another position when locked.

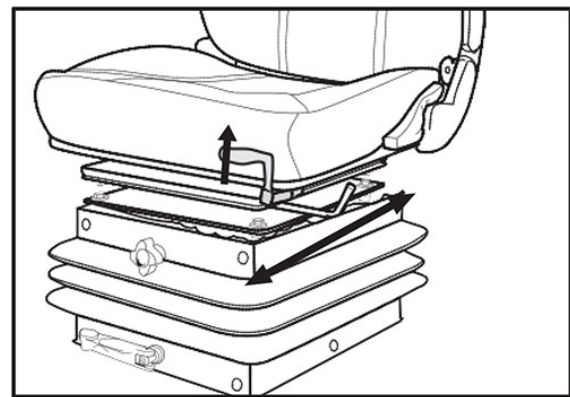

Armrest Adjustment (5)

Inclination of the armrests can be adjusted by turning the adjustment knob. When turning the knob to the outside, the front part of the armrest will be lifted. When turning the knob to the inside, it will be lowered.

NOTE: Armrests can be folded upright and stored in the vertical position.

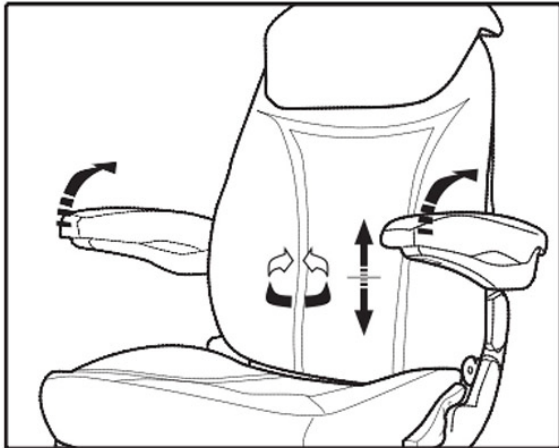

Backrest Extension (6)

The backrest extension can be individually adjusted for height by pulling upwards or downwards to desired position. To remove the backrest extension, pull upwards over the end stop.

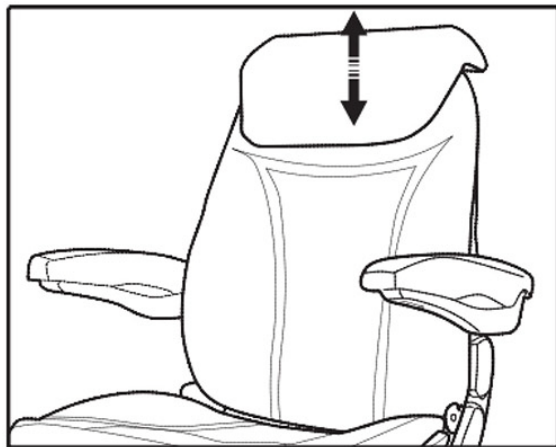

Lumber Support (7)

The curvature of the backrest cushion can be individually adjusted by rotating the adjustment knob to the left.

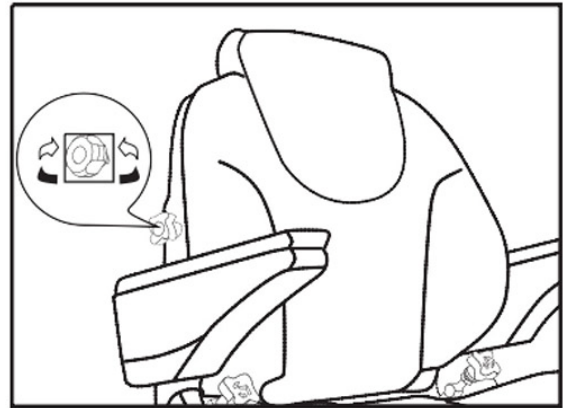

Backrest Adjustment (8)

Pull the locking lever to release the backrest catch. When releasing the backrest catch, do not apply load to the backrest by pressing against it. By exerting pressure on or off the front or rear part of the seat pan, the seat can be moved to the desired position. Release the locking lever to lock the backrest into place.

NOTE: After the lever is locked, the backrest position can no longer be adjusted.

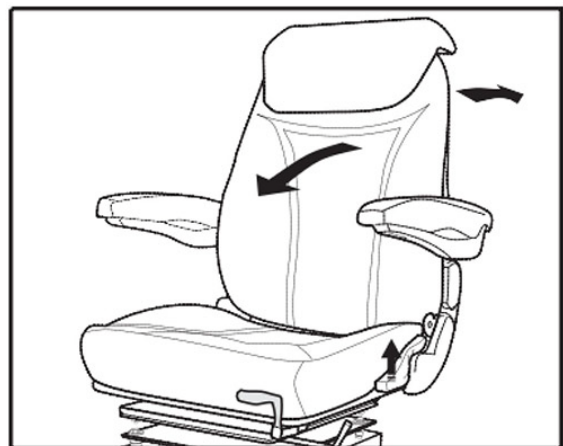

Swivel (9)

 WARNING
Risk of Accident! Do not operate the locking lever while driving the machine.

The swivel is released by pulling the locking lever. The seat can then be swiveled by 15° to the left or right 180°. After adjustment, the locking lever must be fixed into the desired position with an audible click.

NOTE: It is impossible to move the operator's seat to another position when locked.



Seat Belt

Refer to "Seat Belt" provided in the *Safety and Precautions Section* elsewhere in this manual for further information.

SEAT - OPERATOR (PREMIUM)

-If Equipped

⚠ WARNING

This seat may be equipped with a seat heater or ventilation system. There is a possibility that some people may suffer heat-induced burns or excessive cooling when using the system. Do not use either of these systems if you have a diminished ability to sense temperature, a reduced ability to feel pain, or have sensitive skin.

When using the seat heater or ventilation system, do not place anything on the seat that insulates against heat or cooling, such as a blanket, cushion, or similar item. This may cause the seat heater or ventilation system to overheat, which may cause a heat-induced burn or may damage the seat.

Your machine may be equipped with a Premium Air Ride Operator's Seat that is equipped with the following features for your driving and comfort needs.

- (A) - Headrest
- (B) - Heat/Cool Selector Switch
- (C) - Heat/Cool Temperature Switch
- (D) - Armrest Tilt Dial
- (E) - Height Adjustment Switch
- (F) - Recline Lever
- (G) - Slide Release Lever
- (H) - Thigh Tilt Lever
- (I) - Thigh Extension Lever

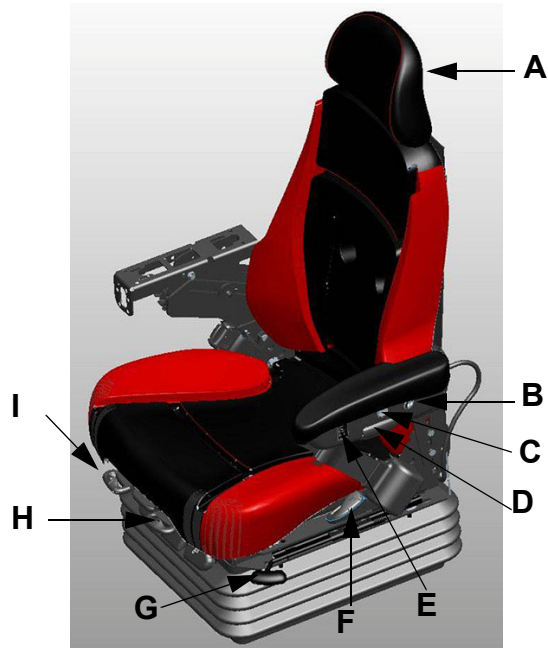

- (J) - Armrest Height Adjuster
- (K) - Fore/Aft Lockout Isolator
- (L) - Lateral Lockout Isolator
- (M) - Ride Firmness Lever



- (N) - Armrest Height/Length Adjuster
- (O) - Lumbar Knob
- (P) - Document Pouch

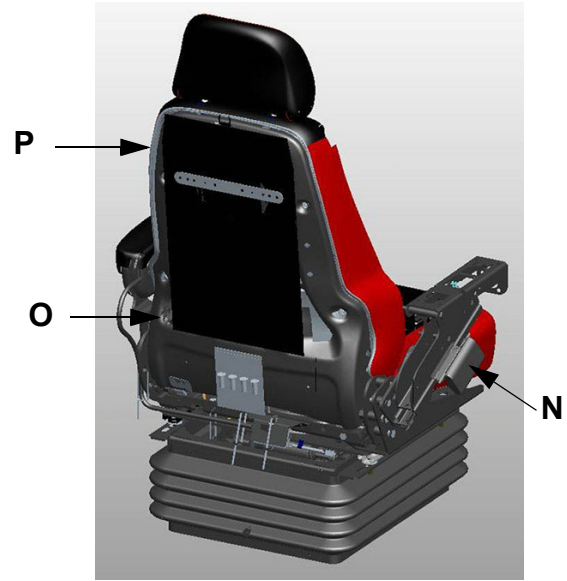

Headrest (A)

(Adjusts height and tilt)

- Firmly grasp headrest and pull UP for higher adjustment.
- Firmly grasp headrest and push DOWN for lower adjustment.

Tilt:

(First Position: hold and rotate down 10-degrees; Second Position: hold and rotate down 20-degrees; Third Position: hold and rotate down 30-degrees. Hold and rotate down to return Headrest to 0-degree position).

Heat/Cool Selector Switch (B)

(Selects between heat and cool settings)

- Press Heat/Cool Selector Switch FORWARD to cool.
- Press Heat/Cool Selector Switch REARWARD to heat.

Heat/Cool Temperature Switch (C)

(Switches heat/cool temperature to high, low, or off settings)

- Press Heat/Cool Temperature Switch UP for HIGH heat or cool.
- Press Heat/Cool Temperature Switch DOWN for LOW heat or cool.
- Press Heat/Cool Temperature Switch to the MID position to turn OFF.

Armrest Tilt Dial (D)**(Tilts armrests)**

- Roll Armrest Tilt Dial (located on each side of operator's seat) INWARD (towards operator) to tilt armrest DOWN.
- Roll Armrest Tilt Dial OUTWARD (away from operator) to tilt armrest UP.

Height Adjustment Switch (E)**(Moves seat up and down)**

- Press Height Adjustment Switch UP to increase seat height.
- Press Height Adjustment Switch DOWN to decrease seat height.

Recline Lever (F)**(Angles back rest cushion)**

- Pull and hold Recline Lever UP to adjust back rest angle. Release lever when desired angle is achieved.

Slide Release Lever (G)**(Moves top of seat fore/aft)**

- Pull and hold Slide Release Lever while sliding seat forward or rearward. Release lever when desired position is achieved.

Thigh Tilt Lever (H)**(Tilts seat cushion up and down)**

- Pull Thigh Tilt Lever UP and hold cushion to adjust +4 degrees. Release lever when desired position is achieved.
- Pull Thigh Tilt Lever UP and push cushion down to adjust -4 degrees. Release lever when desired position is achieved.

Thigh Extension Lever (I)**(Extends seat cushion fore/aft)**

- Pull Thigh Extension Lever UP and hold to adjust cushion +/- 30 mm. Release lever when desired position is achieved.

Armrest Height Adjuster (J)**(Adjusts armrest height)**

- Loosen two (2) bolts and move armrests up or down.
- While maintaining desired armrest position, re-tighten bolts.

Fore/Aft Lockout Isolator (K)**(Locks or unlocks fore/aft isolation)**

- Pull Fore/Aft Lockout Isolator UP to unlock isolation.
- Push Fore/Aft Lockout Isolator DOWN to lock isolation.

Lateral Lockout Isolator (L)**(Locks or unlocks lateral isolation)**

- Pull Lateral Lockout Isolator UP to lock isolation.
- Push Lateral Lockout Isolator DOWN to unlock isolation.

Ride Firmness Lever (M)**(Adjusts ride suspension)**

- Pull Ride Firmness Lever UP for a firmer ride.
- Push Ride Firmness Lever DOWN for a softer ride.

Armrest Height/Length Adjuster (N)**(Adjusts height and length of armrest)**

- Pull and hold Armrest Height/Length Adjuster and slide forward or rearward. Release adjuster when armrest is in desired position.

Fore/Aft Adjustment: +/- 76 mm at 12.7 mm increments; **Up/Down Adjustment** +/- 35 mm at 5.4 mm increments.

NOTE: Armrest tilt fixed position = 25 degrees.

Lumbar Knob (O)**(Adjusts lumbar curvature)**

- Rotate Lumbar Knob INWARD (toward operator) for increased curve.
- Rotate Lumbar Knob OUTWARD (away from operator) for decreased curve.

Document Pouch (P)**(Storage for various machine manuals)**

- Pull Document Pouch Fastener to OPEN.
- Push Document Pouch Fastener to CLOSE.

Seat Belt

Refer to "Seat Belt" provided in the *Safety and Precautions Section* elsewhere in this manual for further information.

SEAT - INSTRUCTOR

The cab is equipped with an Instructor Seat for training operators or diagnosing machine problems. Always wear your seat belt.



Instructor Seat
-Typical View

A storage compartment is provided behind the seat, as well as a set of cup holders on the back side of the seat for your convenience. Fold seat down to access.



-Typical View

OPERATOR'S STATION

Front Console

- (A) - Steering Wheel
- (B) - Hazard/Warning Lights Switch
- (C) - Highway Running Lights Switch
- (D) - Turn Signal Indicator (Left)
- (E) - Highway Running Lights Indicator
- (F) - High Beams Indicator
- (G) - Turn Signal Indicator (Right)
- (H) - Steering Wheel Telescope Adjust Handle, *if equipped*
- (I) - Steering Column Tilt Adjust Button (Knee Angle), *if equipped*
- (J) - Steering Column Release Pedal
- (K) - Operator Foot Pegs (2), *if equipped*
- (L) - Deceleration (Decel) Pedal
- (M) - Horn
- (N) - Windshield Washer
- (O) - Turn Signal Lever
- (P) - Windshield Wiper Speed
- (Q) - High Beams (Brights)

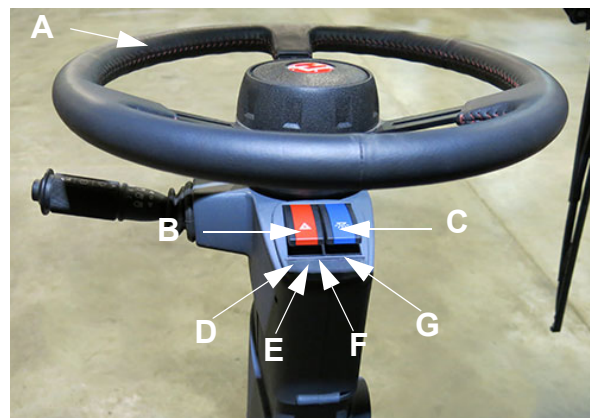

-Typical View

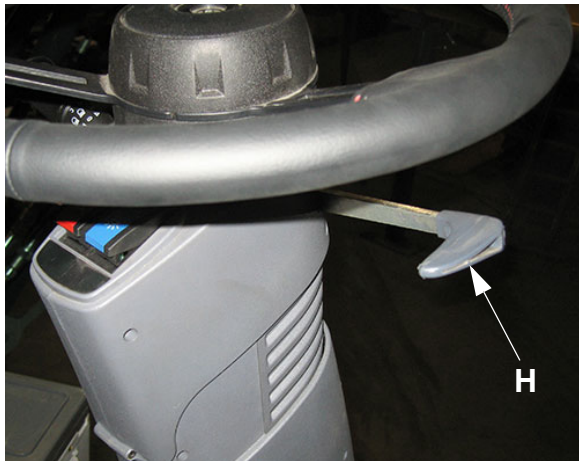

-Typical View
(If equipped)

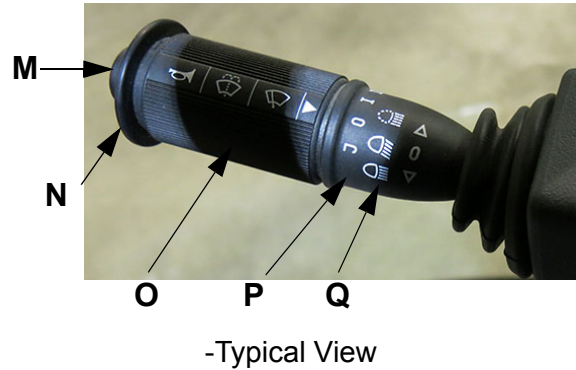

-Typical View

Hazard/Warning Lights Switch

The Hazard/Warning Lights (located on the front of tool bar and rear of machine) are to be used at any time, day or night, that you are traveling on a public roadway, unless prohibited by law.

NOTE: The Hazard/Warning Lights are tied to battery power and will operate when the machine is off. The flashers are disabled in Field Mode.

NOTE: The Hazard/Warning Light Flashers are also activated with the corresponding turn signal.



-Typical View
(If equipped)

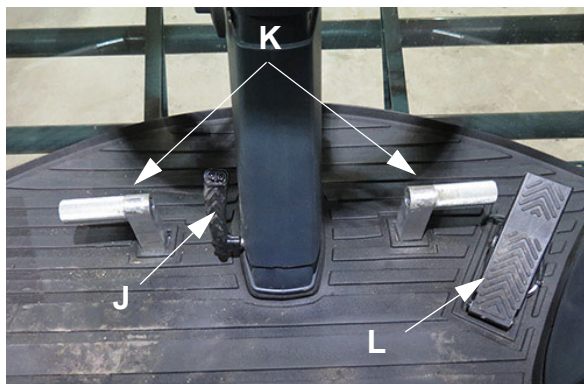

-Typical View

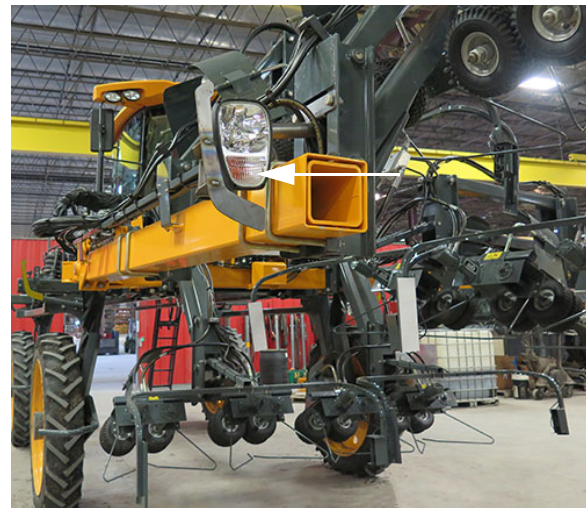

Front Hazard/Warning Light Flashers (2)
-Typical View



Rear Hazard/Warning Light Flashers (2)
-Typical View



Hazard/Warning Lights Switch
(Located on steering column)
-Typical View

Highway Running Lights Switch (Headlights)

The Highway Running Lights (located on the front of tool bar and rear of machine) are to be used when traveling on a public roadway at night.

NOTE: The Highway Running Lights operate in both Road and Field Mode.



Rear Hazard/Warning Light Flashers (2)
-Typical View

To activate the Hazard/Warning Lights:

- Press the Hazard/Warning Lights Switch (located on steering column) in the DOWN (On) position to activate.
- Press the Hazard/Warning Lights Switch in the UP (Off) position to deactivate.

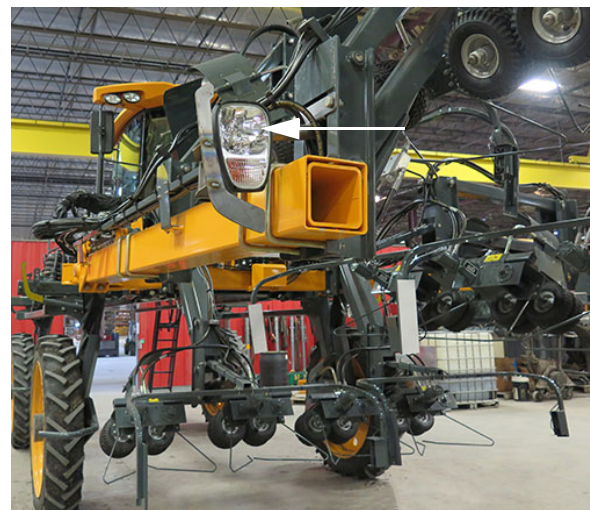

Highway Running Lights (2)
-Typical View

The two rear red taillights are activated any time that the headlights are on.



Rear Taillights
-Typical View

To activate the Highway Running Lights:

- Press the Highway Running Lights Switch (located on steering column) in the DOWN (On) position to activate.
- Press the Highway Running Lights Switch in the UP (Off) position to deactivate.

NOTE: The Highway Running Lights Indicator (located near the steering wheel) will illuminate when activated.



Highway Running Lights Switch
(Located on steering column)
-Typical View

NOTE: Highway Running Lights are enabled when the key is in the ON position. However, prolonged use of these lights without the engine running is not recommended.

Steering Wheel Telescope Adjust

-If Equipped

The Steering Wheel Telescope Adjust allows movement of the upper portion of the steering column to best suit your driving needs.

- To adjust the steering wheel, lift the Steering Wheel Telescope Adjust Handle (located on the right-hand side of steering column) UP to loosen enough to freely move the steering wheel.



Steering Wheel Telescope Adjust Handle
(Located on the right-hand side of steering column)
-Typical View

- With the handle loosened, adjust steering wheel to desired position. While holding the wheel in position, release the Steering Wheel Telescope Adjust Handle to lock into place.

**Steering Column Tilt Adjust
(Knee Angle)**

-If Equipped

The Steering Column Tilt Adjust allows you to angle the top section of the steering column to the position that best suits your comfort needs.

To tilt top section of steering column down:

- Lift and hold the Steering Column Tilt Adjust Button (located on the left-hand side of the steering column) in the UP position.



Steering Column Tilt Adjust Button
(Located on the left-hand
side of the steering column)
-Typical View

- While maintaining the Steering Column Tilt Adjust Button in the upward position, pull steering wheel **BACKWARD** (towards the operator).
- Release button when steering column is in the desired position.

To tilt top section of steering column up:

- Lift and hold the Steering Column Tilt Adjust Button (located on the left-hand side of the steering column) in the **UP** position.
- While maintaining the Steering Column Tilt Adjust Button in the upward position, allow steering wheel to move **FORWARD** (away from the operator).
- Release button when steering column is in the desired position.

Steering Column Release Pedal

⚠ CAUTION

Ensure the steering wheel and steering column are in the locked position before attempting to operate the machine. Failure to comply may result in difficulty maintaining control of the machine.

The Steering Column Release Pedal is featured for ease of exiting and entering the cab.

- With your foot on the Steering Column Release Pedal (located on the lower left-hand side of the steering column), push pedal **DOWN** and move the steering column to desired position.



Steering Column Release Pedal
(Located on the lower left-hand
side of the steering column)
-Typical View

- To lock the steering column in desired position, remove your foot from the Steering Column Release Pedal while holding the steering column in place.
- Once the steering column has engaged into locked position, firmly move the steering column in either direction to ensure security.

Operator Foot Pegs

-If Equipped

Operator Foot Pegs are located on each side of the steering column to provide added comfort and stability while operating the machine.

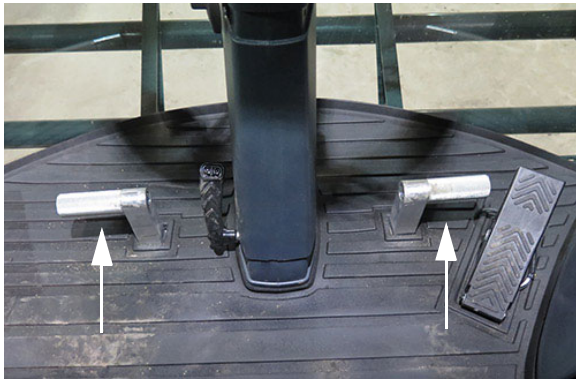

Operator Foot Pegs
(Located on each side
of the steering column)
-Typical View



Decel Pedal
(Located to the lower right-hand
side of the steering column)
-Typical View

Deceleration (Decel) Pedal

 WARNING
Decel Pedal is NOT a brake. It is designated for speed reduction only.

When nearing an end row and speed deceleration is desired, press the Decel Pedal (located to the lower right-hand side of the steering column) to decrease speed.

NOTE: When the Decel Pedal is fully pressed, vehicle speed decreases to 0.



Horn Button
(Located on the end of
the turn signal lever)
-Typical View

Windshield Washer

The Windshield Washer Button is located on the end of the turn signal lever. To apply washer fluid, press and hold button in the IN position. Release button when desired amount of fluid is dispensed.

NOTE: Ensure there is adequate amount of washer fluid in the windshield washer fluid reservoir (located behind the left-hand side of cab) before operating.



Windshield Washer Button
(Located on the end of
the turn signal lever)
-Typical View



Turn Signal Lever
-Typical View

NOTE: Steering column-mounted and Machine Display indicator lights will flash correspondingly when either turn signal is activated.

Windshield Wiper Speed

To increase or decrease Windshield Wiper speed, rotate the turn signal lever forward or backward to achieve Hi, Low, or Intermittent wiper speed.

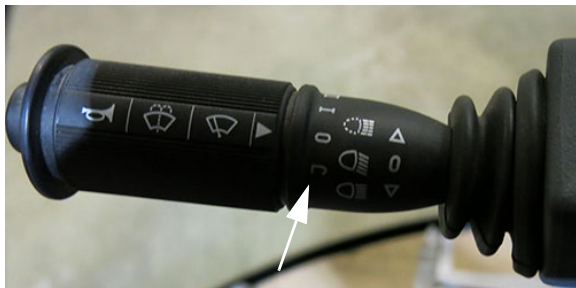

Windshield Wiper Speeds
(Located on the turn signal lever)
-Typical View

High Beams (Brights)

- To turn the High Beams ON, push the turn signal lever (located on the left-hand side of the steering column) DOWN.
- To turn the High Beams OFF, push the turn signal lever UP.

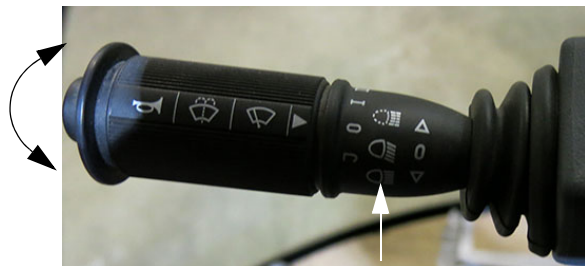

High Beams
(Located on the turn signal lever)
-Typical View

Turn Signals

To activate the front and rear Turn Signals, move the Turn Signal Lever (located on the left-hand side of the steering column) FORWARD (away from operator) to signal a right turn, or BACKWARD (toward operator) to signal a left turn.

NOTE: The machine's drive state must be in Road Mode to activate the Turn Signals.

Side Console

- (A) - Emergency Stop Switch
- (B) - 4-2 Detasseler Switch (if equipped)
- (C) - Traction Valve Switch
- (D) - Ignition Switch
- (E) - Power Mirror Switch (if equipped)
- (F) - Hydrostatic Drive Control Handle
- (G) - All Up/Down Switch
- (H) - Outrigger Fold Switches (Left/Right)
- (I) - Main Motor Switch
- (J) - End Row Management Switch
- (K) - Shift Up Switch
- (L) - Shift Down Switch
- (M) - Parking Brake Switch

- (N) - Throttle Switch
- (O) - Auxiliary 2 Audio Input Connection
- (P) - USB Dual Power Port (Charger)
- (Q) - 12V Power Ports

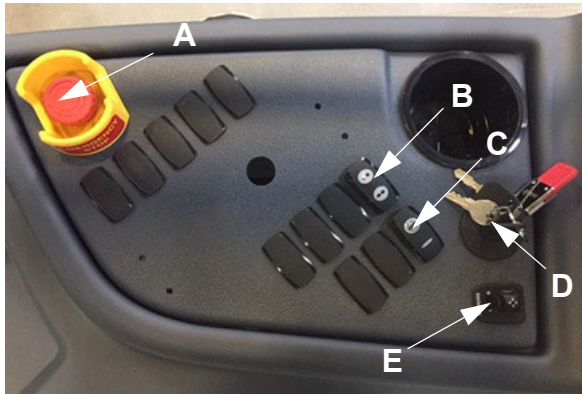

-Typical View

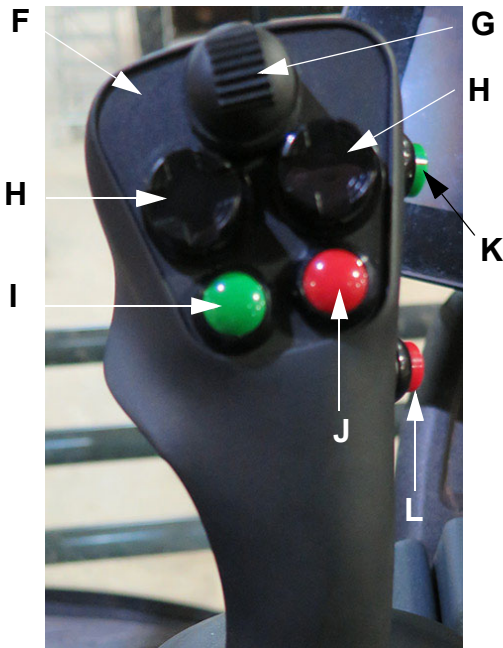

-Typical View

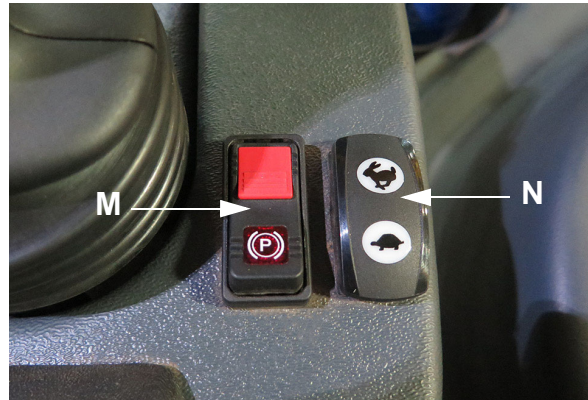

-Typical View

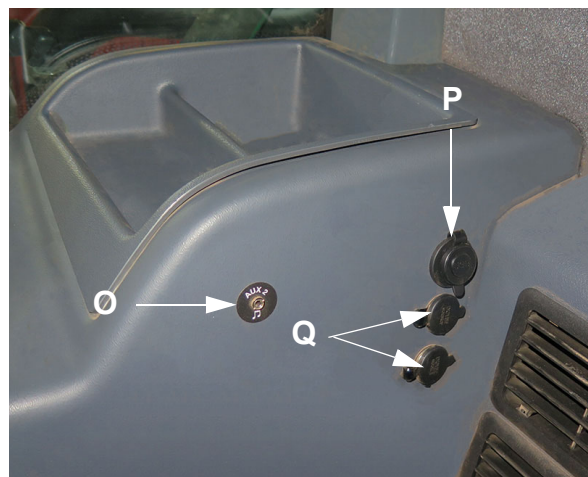

-Typical View

Emergency Stop (E-Stop)

The E-Stop Switch (located on the side console) provides a quick and positive method for stopping the engine in an emergency situation.

NOTICE

Do not use the E-Stop Switch for non-emergency stopping or as a parking brake.



E-Stop Switch
(Located on the side console)
-Typical View

Refer to the *Safety and Precautions Section* provided elsewhere in this manual for further information.

4-2 Detasseler Switch

-If Equipped

The 4-2 Detasseler Switch (located on the side console) is used to hydraulically slide the outer section of the 4-2 Detasseler Tool Bar out an additional 30" (76 cm) on each side.

Refer to "Fold Procedure - Detasseler Tool Bar" provided in the *Detasseling Systems Section* elsewhere in this manual for operating instructions.



4-2 Detasseler Switch
(Located on the side console)
-Typical View

Traction Valve Switch

The Traction Valve Switch (located on the side console) is used to enable traction control on your machine. When the switch is depressed, the left wheels will move at the same speed, and the right wheels will move at the same speed.

- Press the Traction Valve Switch in the UP position to enable traction control.

NOTE: Once the Traction Valve Switch is depressed, traction control will activate for approximately 30 seconds, or until the switch is pressed again.



Traction Valve Switch
(Located on the side console)
-Typical View

When traction control is active, a Traction Valve Indicator (located on the Machine Display Home Page - Road and Field Mode) will illuminate.



Traction Valve Indicator
(Located on the Machine Display
Home Page - Road and Field Mode)
-Typical View

Ignition Switch

The Ignition Switch (located on the side console) has three positions - OFF, ON, and START. Before engaging the starter, turn the ignition key to the ON position and wait for the “wait to start” message to disappear on the Machine Display.

NOTE: The parking brake must be engaged before engaging the starter.



Ignition Switch
(Located on the side console)
-Typical View

- **To engage the starter**, turn the key to the START position and hold momentarily until the engine engages. If the engine does not engage after 15 seconds, turn the key to the OFF position.

NOTE: Constant cranking of the starter will cause damage to the battery and starting system.

Power Mirrors

-If Equipped

Your machine may be equipped with Power Mirrors for your operating convenience.

- Press the L/R Lever in the “L” position to adjust the LEFT mirror or in the “R” position to adjust the RIGHT mirror.
- Press the Adjust Switch to adjust the corresponding mirror to desired position.

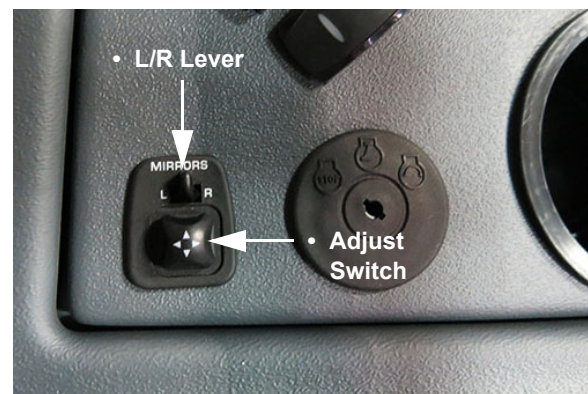

Power Mirror Switch
(Located on the side console)
-Typical View

Hydrostatic Drive Control Handle

The Hydrostatic Drive Control Handle controls the direction of the machine and the speed in which it travels. It is also used to control the outriggers, master control, end row management, and shift up/down speeds.

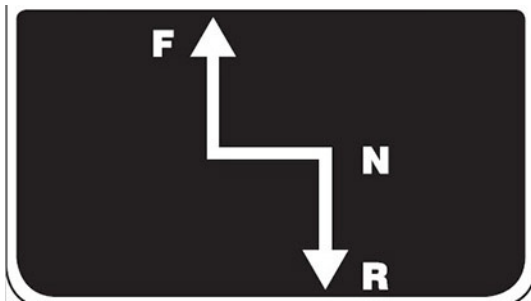

Hydrostatic Drive Control Handle
-Typical View

Refer to the *Engine and Drive Systems* and *Detasseling Systems Sections* elsewhere in this manual for further information.

All Up/Down Switch (A)

The All Up/Down Switch (located on the Hydrostatic Drive Control Handle) is used to raise or lower all row units at the same time.

Outrigger Fold Switches - Left/Right (B)

The hydraulic Outrigger Fold Switches (located on the Hydrostatic Drive Control Handle) are used to hydraulically fold/unfold the outriggers.

Main Motor Switch (C)

The detasseling head motors are controlled by the Main Motor Switch (located on the Hydrostatic Drive Control Handle). This switch must be in the ON position to enable detasseling head operation.

End Row Management Switch (D)

The End Row Management Switch (located on the Hydrostatic Drive Control Handle) is a programmable switch that enables various functions (i.e. All-Wheel Steer, Auto Steer, and Main Control) when the switch is depressed.

NOTE: End Row Management functions are disabled in Road Mode.

Refer to “Machine Display” provided elsewhere in this section for programming information.

Shift Up/Down Switches (E and F)

The Shift Up/Down Switches (located on the Hydrostatic Drive Control Handle) are used for speed range selection.

Refer to “Hydrostatic Drive” provided in the *Engine and Drive Systems Section* elsewhere in this manual for further information.

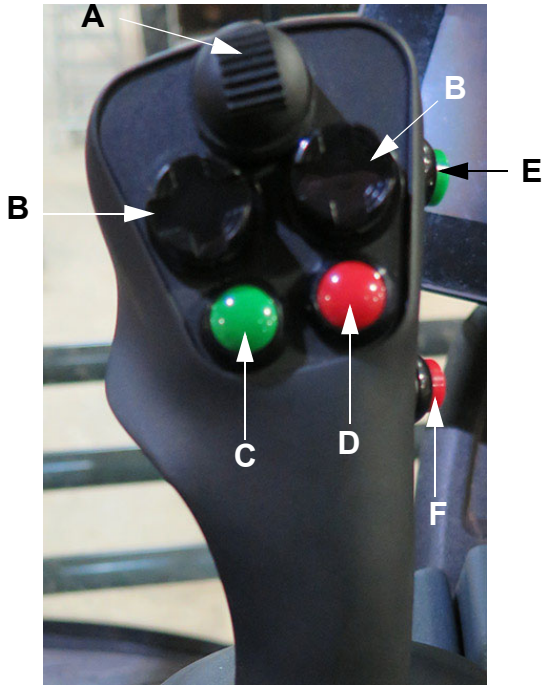

- (A) - All Up/Down Switch
- (B) - Outrigger Fold Switches - Left/Right
- (C) - Main Control Switch
- (D) - End Row Management Switch
- (E) - Shift Up Switch
- (F) - Shift Down Switch

Parking Brake Switch

⚠ CAUTION

Do not engage the parking brake while the machine is moving. Failure to comply may result in personal injury and machine damage.

NOTICE

The parking brake is not intended for normal or emergency stopping.

The Parking Brake Switch (located near the Hydrostatic Drive Control Handle) is used to engage/disengage the parking brake, as well as extend/retract the ladder.



Parking Brake Switch
(Located near the Hydrostatic Drive Control Handle)
-Typical View

Refer to “Hydrostatic Drive” provided in the *Engine and Drive Systems Section* elsewhere in this manual for further information.

Throttle Switch

The Throttle Switch (located near the Hydrostatic Drive Control Handle) is used to control engine speed (RPM).

NOTE: The operator may select throttle setting by operating the Throttle Switch. However, engine speed is also controlled by movement of the Hydrostatic Drive Control Handle.

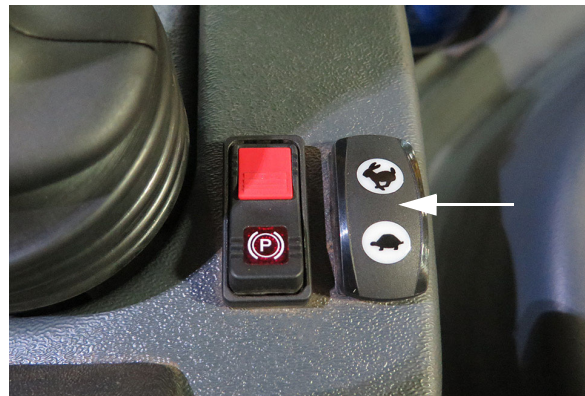

Throttle Switch
(Located near the Hydrostatic Drive Control Handle)
-Typical View

SECTION 3 – CAB



NOTE: Engine speed can range between 850 and 2300 RPM in both Road and Field Mode.

The Throttle Switch works with a timer to tell the engine how fast to run. The longer the operator holds the switch in either direction (press UP/“rabbit icon” to increase the speed, press DOWN/“turtle icon” to decrease the speed), the more the engine will speed up or slow down.

Auxiliary Audio Input Connection (Aux 2)

The Aux 2 Audio Input Connection (located on the inward side console panel) allows you to connect a personal i-Pod or MP3 player.

NOTE: An Aux 1 Audio Input Connection is located on the stereo/radio.

USB Dual Power Port (Charger)

The USB Dual Power Port (located on the inward side console panel) is a 1.5 A charge port to allow you to charge your phone or tablet.

Power Ports (12-Volt)

Three (3) Power Ports (two located on the inward side console panel and one located along the lower left-hand side of operator’s seat) are provided for the connection of additional items, such as radios and computer equipment.

NOTE: The Power Ports are not intended for the permanent connection of additional systems to the sprayer.

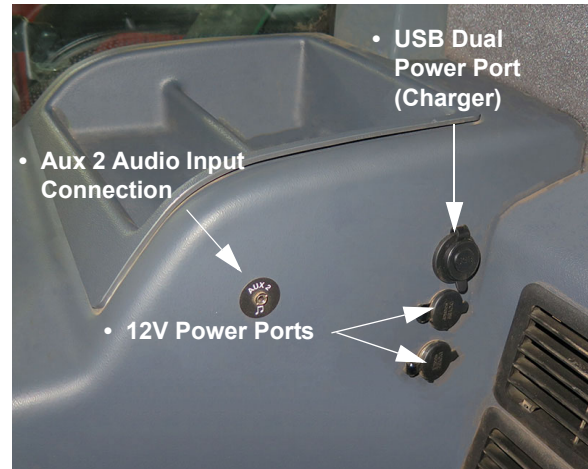

-Typical View

Overhead Monitors and Controls

- (A) - Courtesy Light/Interior Work Light
- (B) - Stereo
- (C) - Climate Controls
- (D) - Machine Display
- (E) - Machine Gauges



-Typical View



-Typical View



Standard



Optional

-Typical View

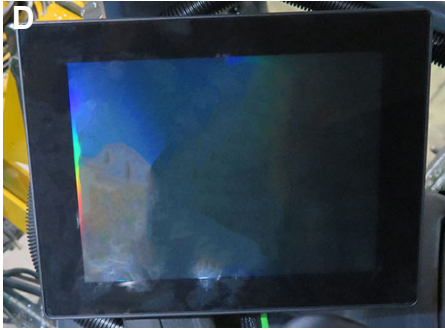

-Typical View



Interior Work Light Switch
-Typical View



-Typical View

Stereo

The Stereo in your cab is featured with an AM/FM Tuner, Weatherband Broadcasting, MP3 Player, USB/iPod Controls, and Bluetooth®.

Refer to the Stereo manufacturer's owner's manual for complete operating instructions and programming information.



Climate Controls (Standard)



-Typical View

Courtesy Light/Interior Work Light

The Courtesy Light comes on automatically when the cab door is opened.

The Interior Work Light is activated by manually by pressing the Interior Work Light Switch (located on the light housing).

- Press switch UP to turn interior “white” light ON.
- Press switch DOWN to turn interior “red” light ON.
- Press switch in the mid-position to turn OFF.

Fan Blower Speed (A)

- Rotate the Fan Blower Speed Dial “clockwise” to increase fan speed.
- Rotate the Fan Blower Speed Dial “counter-clockwise” to decrease fan speed.
- To shut the fan off, rotate the Fan Blower Speed Dial fully “counter-clockwise”.

Temperature Setting (B)

- Rotate the Temperature Setting Dial “clockwise” to increase temperature.
- Rotate the Temperature Setting Dial “counter-clockwise” to decrease temperature.

Air Conditioner Switch (C)

- To activate the air conditioner, press the Air Conditioner Switch in the ON position (toward switch indicator). Adjust the fan speed and temperature accordingly.

Climate Controls (Optional)

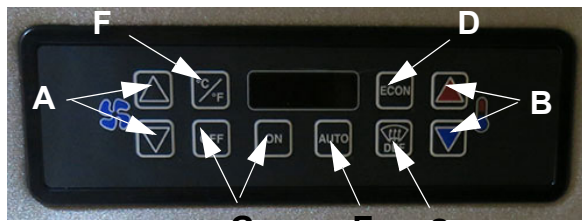

-Typical View

Fan Up/Down (A)

The Fan Up/Down Switches control the fan speed up or down in 11 increments and overrides the automatic fan speed control.

- Press desired switch UP to increase fan speed, or DOWN to decrease fan speed.
- The Digital Display indicates the fan speed setting as a percentage, or “HI” when maximum fan speed is obtained, or “LO” when minimum fan speed is obtained.

NOTE: The Digital Display will return to the normal display five seconds after either key is depressed. The set point fan speed is maintained until it is changed, or until the Auto Mode Switch is depressed.

Temperature Up/Down (B)

The Temperature Up/Down Switches increments the cab set point temperature.

- Press desired switch UP to increase temperature, or DOWN to decrease temperature.

Defrost (C)

The Defrost Switch energizes the A/C system to allow for rapid cab dehumidification.

- Press the Defrost (DEF) Switch to turn ON.

NOTE: An indicator light will illuminate when defrost mode is active.

Economy Mode (D)

Economy Mode uses fresh air, fan speed, and water valve control to maintain the set point temperature. When active, A/C function is disabled.

- Press the Econ Switch to turn ON.
- Press the Econ Switch again to return the system back to normal operation.

NOTE: An indicator light will illuminate when Economy Mode is active.

Auto Mode (E)

Auto Mode allows the system to function in fully automatic temperature control mode, including automatic fan speed control. The system will adjust the fan speed to the lowest setting required to maintain cab set point temperature.

- Press the Auto Switch to turn ON and OFF.

NOTE: An indicator light will illuminate when auto mode is active.

Cab Temperature (F)

- Press the Cab Temp Switch to display set point on the Digital Display.

NOTE: Press the Cab Temp Switch and toggle between celsius (C) and fahrenheit (F) temperatures.

NOTE: Current cab temperature will be displayed for five seconds, then will return to the set point temperature display.

On/Off (G)

- The On/Off Switches power the cab heater/air conditioner systems ON or OFF.

NOTE: An LED numeric display is illuminated when the unit is turned on. The Digital Display will show the current set point temperature.

Cab Vents

Your cab is equipped with adjustable vents. Rotate to desired position, or individually turn on or off with the directional fins.



Cab Vent
-Typical View

Machine Display

The Machine Display in your cab is the central control center of the machine. It controls many of the machine's electronically-driven functions (i.e. machine drive, AWS, tread adjustment, lights, diagnostics, etc., as well as the Tasselrol™ XL detasseling system).



Machine Display
-Typical View

Refer to “Machine Display” provided elsewhere in this section for a complete list of features and operating instructions.

Machine Gauges

Machine Gauges are located on the A-post in your cab and are conveniently placed for viewing machine diagnostics.

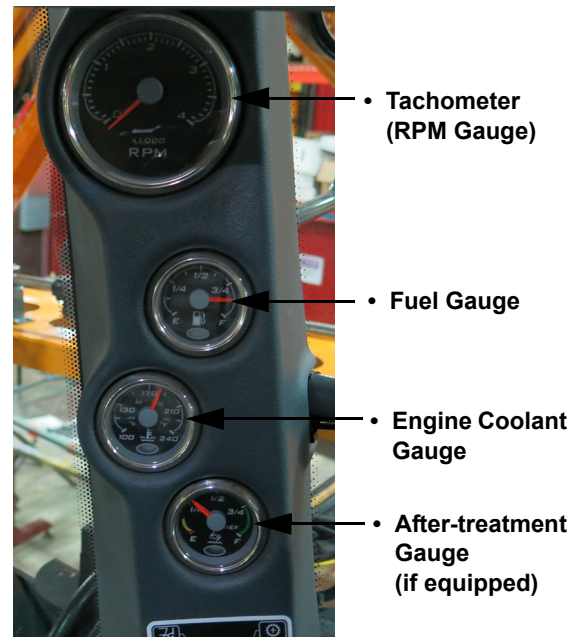

Machine Gauges
(Located on cab A-post)
-Typical View

Lighting

NOTE: See Front Console components discussed earlier in this section for information on Hazard/Warning Lights and Highway Running Lights.

Field Lights

The Field Lights (located on the front of cab) are for use when operating in the field after dark and are turned on/off through the Machine Display.

NOTE: Turn the Field Lights OFF before entering a public roadway.

- Field Light 1
- Field Light 2
- Field Light 2
- Field Light 1



Field Lights (4)
(Located on the front of cab)
-Typical View

NOTE: The ignition key must be in the ON position to operate the Field Lights.

Refer to “Machine Display” provided elsewhere in this section for operating instructions.

Cab Filtration

RESPA® Cab Filter

Your cab is featured with a dust and aerosol filtration system to provide continuous positive pressure in the cab by reducing exposure to harmful particulates.

NOTE: The filtration system will activate automatically approximately 10 seconds after machine start-up.

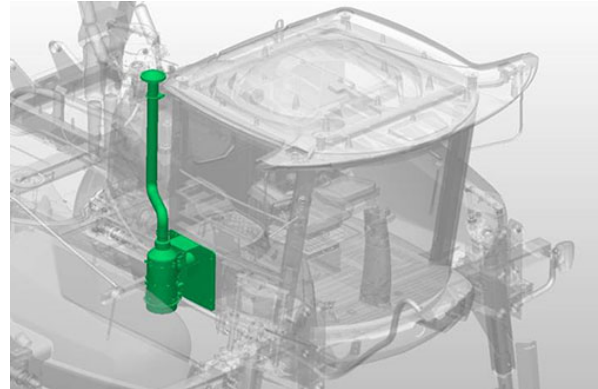

Cab Filtration System
(Located on the right-hand side of the exterior cab)
-Typical View

An indicator light (located on the Machine Display Home Page) will appear if insufficient cab air pressure should occur.

NOTE: The Insufficient Cab Air Pressure Indicator will appear each time the machine is started due to the initial activation delay. The indicator will disappear once the cab becomes pressurized.

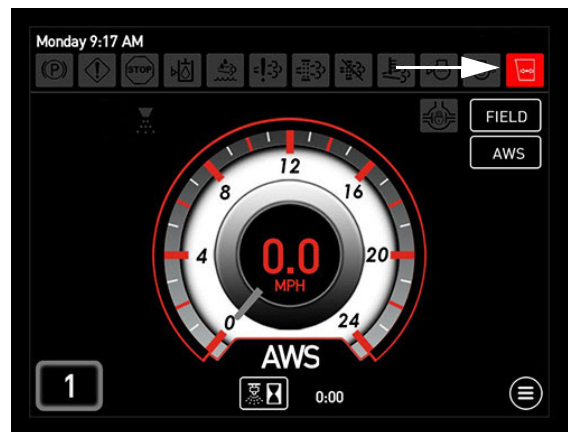

Insufficient Cab Air Pressure Indicator
(Located on the Machine Display Home Page - Road or Field Mode)

Refer to “Service - Filters” provided in the *Maintenance and Storage Section* elsewhere in this manual for filter replacement information.

Charcoal/Recirculation Filters

Your cab is featured with a Charcoal Filter (located behind the exterior service panel on the right-hand side of cab), which eliminates hazardous chemicals from the operator's station. In addition, a Recirculation Filter (accessible after the Charcoal Filter has been removed) is provided to cleanse air inside the cab, keeping the operator's environment fresh.



Charcoal Filter
(Located behind the exterior service panel on the right-hand side of cab)
-Typical View

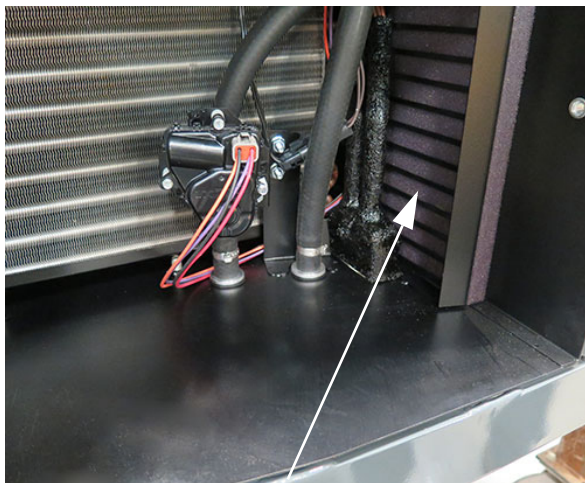

Recirculation Filter
(Located along the right-hand side of service compartment)
-Typical View

* View shown with charcoal filter removed

Refer to "Service - Filters" provided in the *Maintenance and Storage Section* elsewhere in this manual for further information on filter maintenance.

Additional Features

Portable Electric Cooler

-If Equipped

Your machine may be equipped with a Portable Electric Cooler (located beneath the Instructor Seat) for your personal convenience. A 12-volt connection outlet is provided along side of the operator's seat.

MACHINE DISPLAY

The Machine Display is the central control center of the machine. It controls many of the machine's electronically-driven functions, such as:

- Machine Drive
- All-Wheel Steer (if equipped)
- Hydraulic Tread Adjustment (if equipped)
- Reversible Fan
- Rear-View Camera
- Exterior Lighting
- Engine/Machine Diagnostics
- Tasselrol™ XL Detasseling System

Date and Time

To Adjust Date and Time

- Press either the Day/Time or the Date (located along the top left and right-hand side of each display page) to navigate to the "Date/Time" screen.

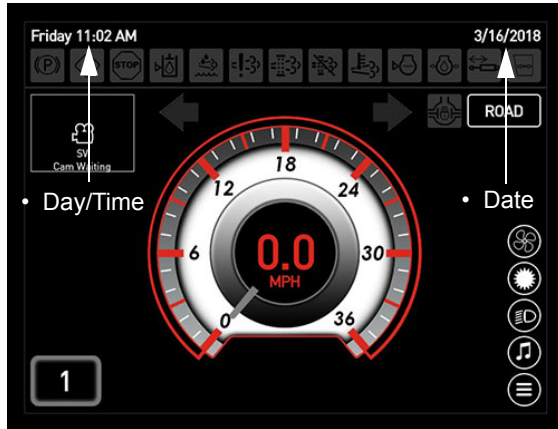

Date and Time

(Located along the top left and right-hand side of each display page)

- On the “Date/Time” screen, press any cell in the Date row (to change date), or any cell in the Time row (to change time).

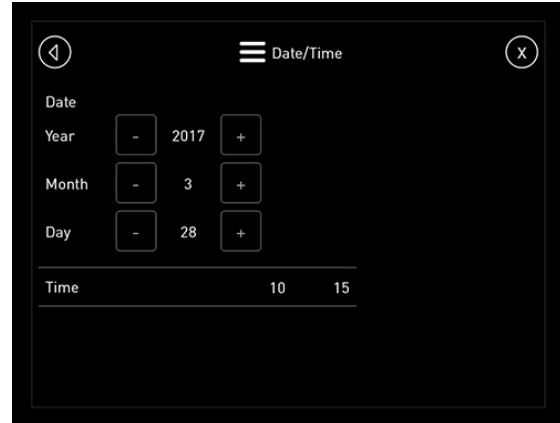

- Press the Back or Exit Button when finished.

NOTE: The date and time may also be modified through the “Adjustments” screen (Main Menu>Adjustments>Adjust Time).

Drive State

The drive state of the machine is displayed on the Home Page - Road and Field Mode.

- Press the Field/Road Button (located on the Home Page) to toggle between the two drive states.

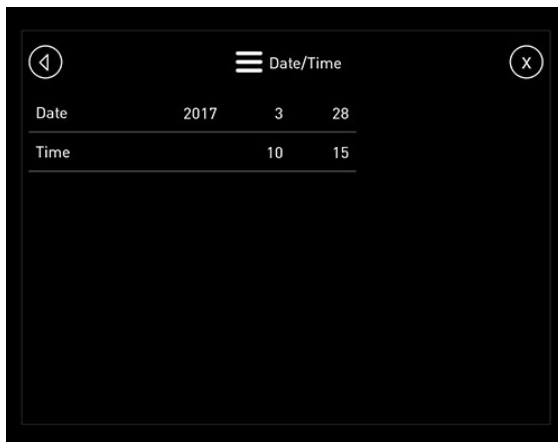

Date/Time Screen

- Press the “+” or “-” Button(s) to adjust Date or Time accordingly.

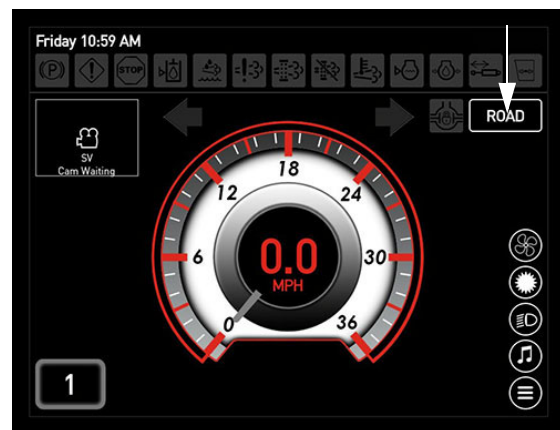

**Field/Road Button
(Home Page - Road Mode)**

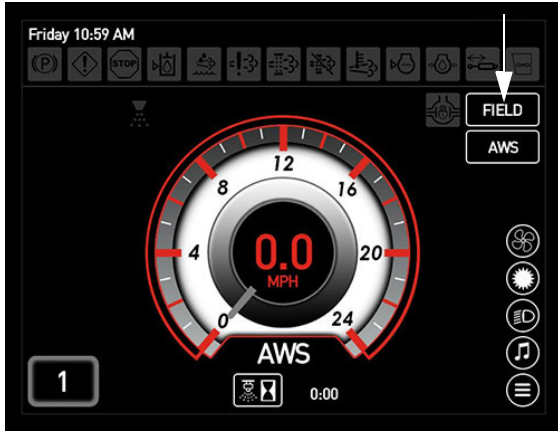

Field/Road Button
(Home Page - Field Mode)

NOTE: The drive state of the machine cannot be changed unless the Hydrostatic Drive Control Handle is in the NEUTRAL position (and machine speed is less than 0.5 mph/ 0.8 km/h).

The machine is featured with three (3) drive states: Road Mode, Field Mode, and Drive Fault. The drive state helps the machine determine what kind of work it is meant to do - field work or transport work.

Road Mode

In Road Mode, the machine is limited on what functions can be operated. Road Mode is used for transporting the machine and therefore, will allow the machine to reach maximum speed.

NOTE: Engine speed in Road Mode can range from 850 to 2300 RPM.

Field Mode

In Field Mode, the machine is allowed function of the detasseler heads and All-Wheel Steer (if equipped).

NOTE: Machine speed is limited and is unable to reach maximum speed while in Field Mode.

Drive Fault

The third drive state, “Drive Fault” may appear as a warning message on the display page if there is a system malfunction that affects the machine’s ability to function

properly. This message will tell you why the error occurred and what, if anything, should be done to correct the issue. As a result, machine performance will be limited.

NOTE: When a Drive Fault is present, the Field/Road Button (located on the Home Page) will be replaced by “FAULT”. Settings will be in Field Mode.

Speedometer

The speed in which the machine travels is displayed on the Home Page - Road and Field Mode. The unit of measure can be viewed as miles per hour (mph) or kilometers per hour (km/h).

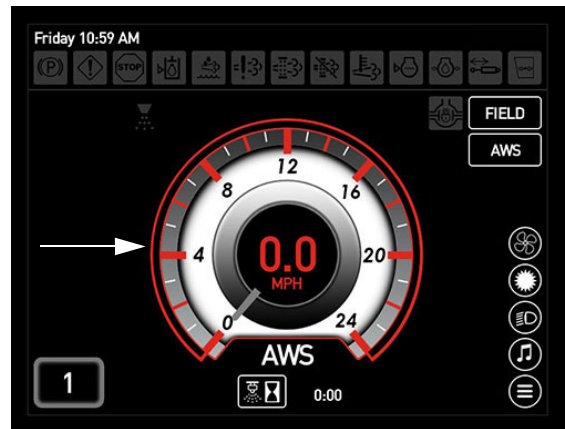

Speedometer
(Located on the Home Page - Road and Field Mode)

NOTE: Press the center of the Speedometer to navigate to the “Speed Settings” screen.

NOTE: See “Main Menu” for information on changing the unit of measure.

Speed Range

Your machine is featured with three speed ranges - Speed Range 1, Speed Range 2, and Speed Range 3. The Speed Range selected is displayed on the Home Page - Road and Field Mode.

See “Speed Settings” in the Main Menu section for further information.

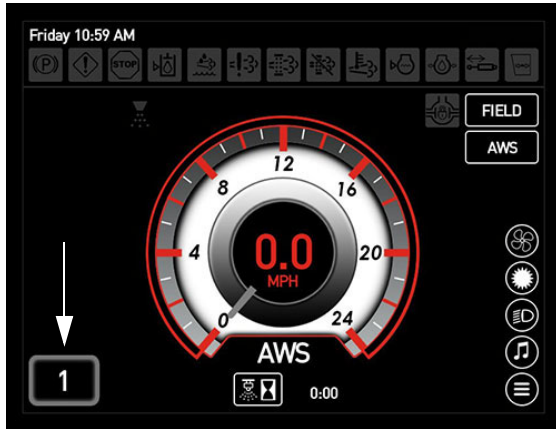

Speed Range
(Located on the Home Page
- Road and Field Mode)

Warning Indicator Lamps

To alert the operator of certain operations or when a machine system requires attention, various warning indicators are located on the top of each display page and illuminate to inform you of a specific situation.

- Parking Brake ON
- Check Engine/Alert Lamp (for non-engine related faults)
- Stop Engine/Stop Machine (for severe fault)
- Low Hydraulic Oil Level
- Low Diesel Exhaust Fluid (DEF) (Final Tier 4 Engines)
- Engine Emissions System Failure/Malfunction
- Exhaust System Cleaning (Manual Regen)
- Engine Cleaning Stop (Inhibit Regen)
- High Exhaust Temperature (HEST)
- Low Engine Coolant Level
- Low Engine Oil Pressure
- Glow Plugs Active/Wait to Start
- Insufficient Cab Air Pressure

Display Buttons



- Home Button



- Main Menu Button



- Reset Button
NOTE: The Reset Button resets setting back to default value.



- Information/Help Button



- Back Button



- Accept Button



- Exit Button



- Phone Button (Answer)



- Phone Button (Reject/Hang Up)
NOTE: If a phone is connected to the radio via bluetooth and a call is received, two (2) Phone Buttons will appear on the Home Page and the Audio Page (if "Show Shortcuts" is enabled). Press the top button to ANSWER the phone call. Press the bottom button to REJECT/HANG UP the phone call.

pressing the Sound Muted Button (*Main Menu Page>Preferences*). However, the corresponding warning indicator lamp (located along the top of each display page) will remain illuminated until the issue has been corrected.

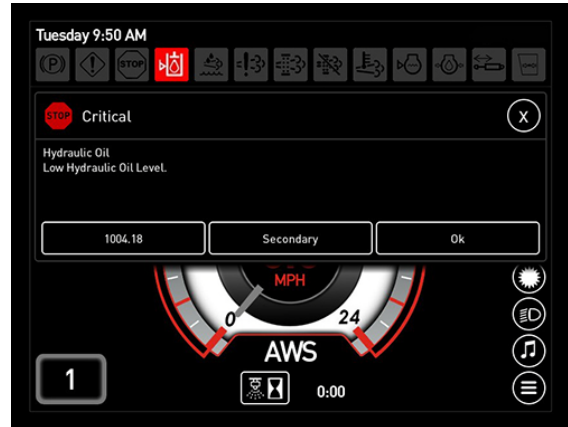

Warning Message

NOTE: The Sound Button will reset to the ON (enabled) position each time the ignition key is cycled.

Rear-View Camera

Your machine is equipped with a Rear-View Camera for your safety and convenience when operating the machine in reverse and is integrated into the rear hood.

- Press the Camera Button (located on the Home Page - Road Mode) to navigate to the "Rear-View Camera" screen.

NOTE: You may also navigate to the "Rear-View Camera" screen through the Main Menu Page.

Warning Messages/Alarm

When a system requires attention, a warning message will appear on any given display page telling you what the error is and what should be done to correct it. The warning message will be accompanied by a warning alarm.

The warning message may be cleared by pressing OK to acknowledge the message and the warning alarm may be silenced by

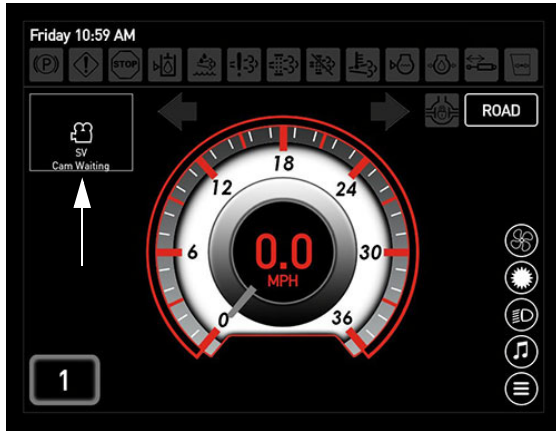

Camera Button
(Located on the Home Page - Road Mode)

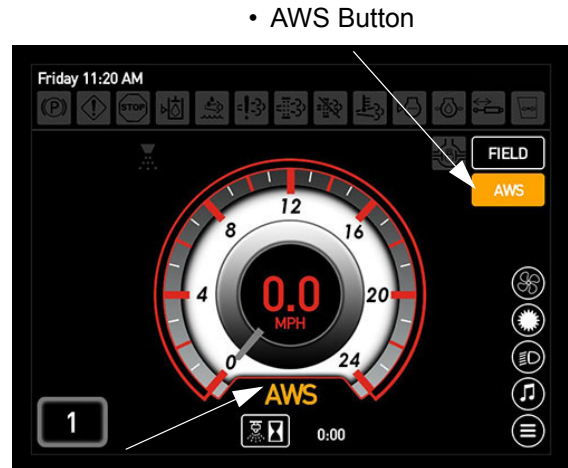

• AWS Indicator

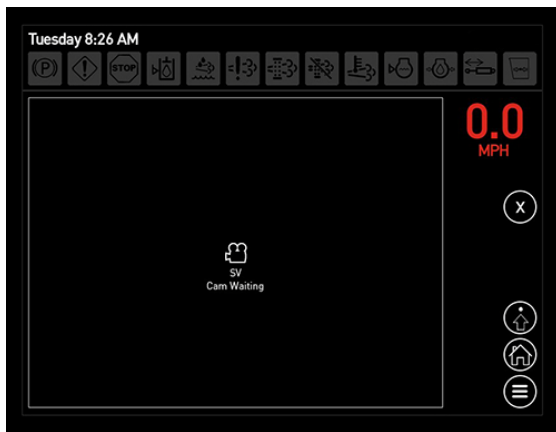

Rear-View Camera Screen

The operator may turn the Rear-View Camera on or off in reverse mode, as well as install multiple cameras on the machine. Refer to “Rear-View Camera” in the Main Menu section for further information.

All-Wheel Steer (AWS)

-If Equipped

The AWS Button is located on the Home Page - Field Mode. Enable AWS by pressing the button in the ON (illuminated) position. An AWS indicator (located below the speedometer) will illuminate when AWS is activated (requiring all conditions to be met).

All conditions must be met before AWS will activate. First, the machine must be in Field Mode, and second, machine speed must be less than AWS Shutoff Speed. If these conditions are not met, the AWS Button will remain ON, but the AWS indicator will turn OFF, and the machine will be operating in conventional steering mode. When conditions are met again, AWS will automatically activate and the AWS indicator will illuminate.

NOTE: The machine will automatically determine if the proper conditions have been met and change the status of the drive functions.

AWS Shutoff Speed

AWS Shutoff Speed can be changed through the Speed Settings on the Main Menu Page. In addition, the “Speed Settings” screen may also be accessed directly by pressing the center of the speedometer.

See “Speed Settings” information in the Main Menu section for further information.

NOTE: AWS Shutoff Speed default is set to 10 mph (16 km/h).

NOTE: AWS Shutoff Speed may only be adjusted in Speed Range 1 or 2.

Refer to “All-Wheel Steer” provided in the *Engine and Drive Systems Section* elsewhere in this manual for complete operating instructions and safety precautions.

Main Menu

The Main Menu Page features various machine settings, such as:

- Home
- Exterior Lighting
- Hydraulic Tread Width Adjustment (if equipped)
- Engine Diagnostics
- Attachment
- Speed Settings
- Brightness (Display, Side Console, Machine Gauges)
- End Row Management
- Reversible Fan
- Rear-View Camera
- Audio (Radio/MP3/Bluetooth)
- Machine Adjustments
- Display Preferences
- System Faults
- Measure

- Press the Main Menu Button (located on the Home Page - Road and Field Mode) to navigate to the Main Menu Page.

NOTE: You may also press the Main Menu Button (located on the bottom right-hand corner of each display page) to navigate directly to the Main Menu Page.

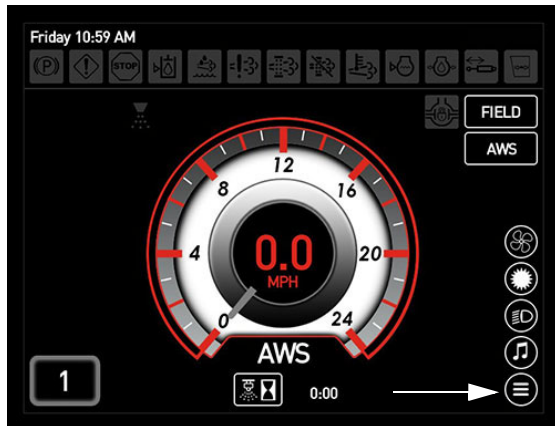

Main Menu Button
(Located on the Home Page
- Road and Field Mode)



Main Menu

Home

- Press the Home Button to navigate back to the Home Page - Road/Field Mode.

NOTE: You may also press the Home Button (located on the bottom right-hand corner of each display page) at any time to navigate directly to the Home Page.



Home Button
(Located on the Main Menu Page)

Exterior Lighting

(Field Lights)

- Press the Lights Button to navigate to the “Exterior Lighting” screen.



Lights Button
(Located on the Main Menu Page)



Exterior Lighting Screen

NOTE: The light buttons will illuminate when in the ON position.

Field Lights

The Field Lights are located on the front of the cab.

- Press the Field Lights Button(s) (FLD1 and/or FLD2) to turn Field Lights ON. Press button(s) again to turn Field Lights OFF.

NOTE: Turn the Field Lights OFF before entering a public roadway.

NOTE: The ignition key must be in the ON position to operate the Field Lights.

Attachment Lights

- If Equipped

A harness drop is located on the left-hand side of tool bar to allow the operator to install additional add-on Attachment Lighting.

- Press the Attachment Lights Button (ATCH) to turn Attachment Lights ON. Press button again to turn Attachment Lights OFF.

NOTE: Turn the Attachment Lights OFF before entering a public roadway.

NOTE: The ignition key must be in the ON position to operate the Attachment Lights.

All Lights

- Press the All Lights Button (ALL) to turn on both sets of Field Lights (Field Lights 1 and 2) and Attachment Lights (if equipped). Press button again to turn all lights OFF.

NOTE: The ignition key must be in the ON position to operate the Field Lights and Attachment Lights (if equipped).

Lights Settings

The “Lights Settings” screen is used in conjunction with the lights shortcut action on the Home Page - Road and Field Mode. The operator can choose which lights to have on for each setting, which will allow toggling back and forth between the two settings when the Lights Shortcut Button on the Home Page is pressed.

NOTE: The Show Shortcuts option must be enabled (Main Menu>Preferences) to be able to toggle between the two settings from the Home Page.

- On the “Exterior Lighting” screen, press the Settings Button to navigate to the “Lights Settings” screen.

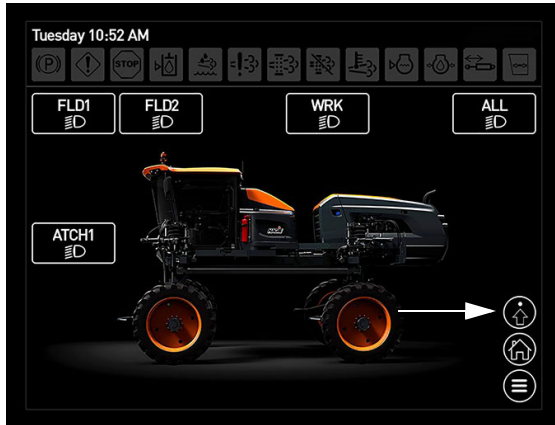

Settings Button
(Located on the Exterior Lighting Screen)

- On the “Lights Settings” screen, press the cell (next to Lights Shortcut Action) and select ALL LIGHTS or TOGGLE 2 SETTINGS.

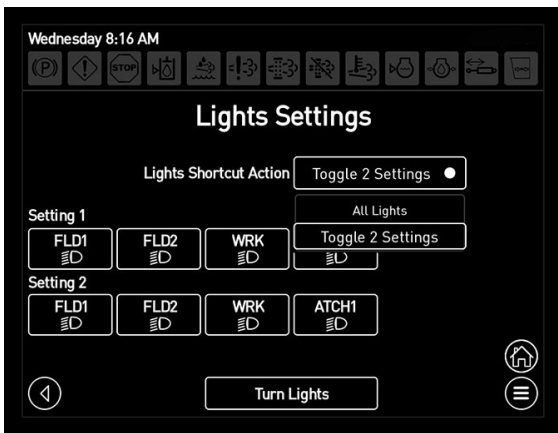

Lights Settings Screen

All Lights

When ALL LIGHTS is selected, the Field Lights and Attachment Lights (if equipped) will all activate/deactivate when the Lights Shortcut Button on the Home Page is pressed.

Toggle 2 Settings

When TOGGLE 2 SETTINGS is selected, only the desired lights pre-selected for each setting will activate/deactivate when the Lights Shortcut Button is pressed.

- On the “Lights Settings” screen, press the cell next to Lights Shortcut Action and select TOGGLE 2 SETTINGS.

- Select desired lights that you wish to activate/deactivate for each setting.

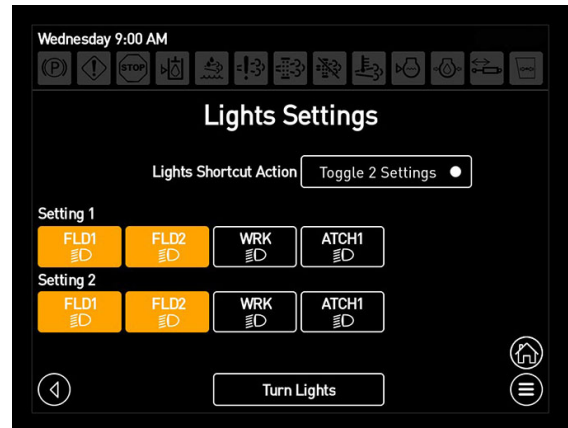

Lights Settings Screen - Toggle 2 Settings

- You may now toggle between the two lights settings by pressing the Lights Shortcut Button on the Home Page.

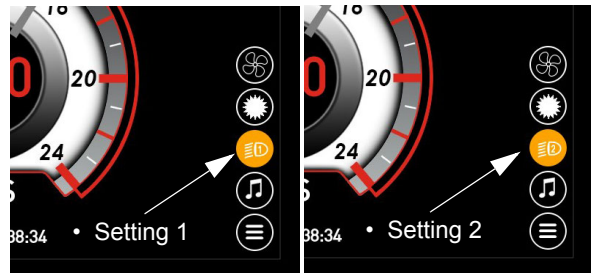

Lights Shortcut Button - Setting 1/2
(Located on the Home Page - Road and Field Mode)

NOTE: If toggling between the two lights settings, it is necessary to navigate to the “Exterior Lighting” screen and manually turn all lights OFF prior.

NOTE: Press and hold the Lights Shortcut Button to navigate directly to the “Exterior Lighting” screen (for whichever setting is currently selected on the Home Page).

A Turn Lights Button is located on the “Lights Settings” screen (Toggle 2 Settings). When this button is activated, both of the outer Field Lights (Field Lights 1) will turn on when either turn signal is active.

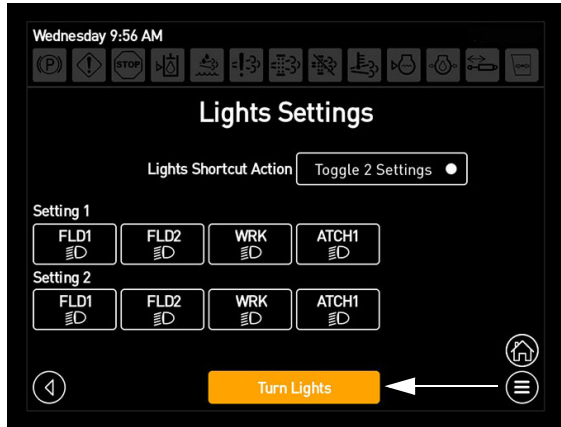

Turn Lights Button
(Located on the Lights Settings Screen -
Toggle 2 Settings)

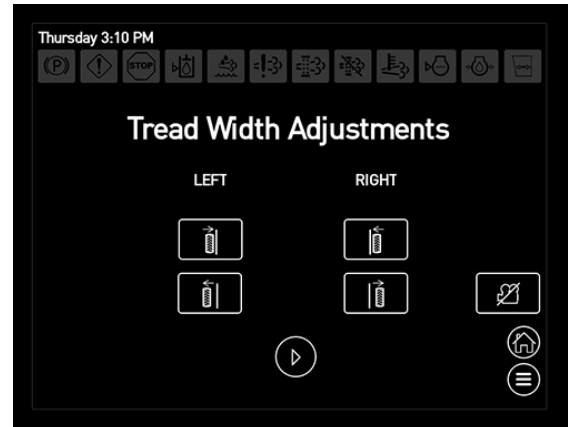

Tread Width Adjustments Screen

- If desired, press the Arrow Button (located on the “Tread Width Adjustments” screen) to navigate to the “Multiple Tread” screen.

Hydraulic Tread Width Adjustment

-If Equipped

Hydraulic Tread Width can be individually adjusted by pressing and holding the corresponding Tread Width Adjustment Button (located on the “Tread Width Adjustments” screen). If desired, multiple tread widths may be adjusted simultaneously.

- Press the Tread Button to navigate to the “Tread Width Adjustments” screen.

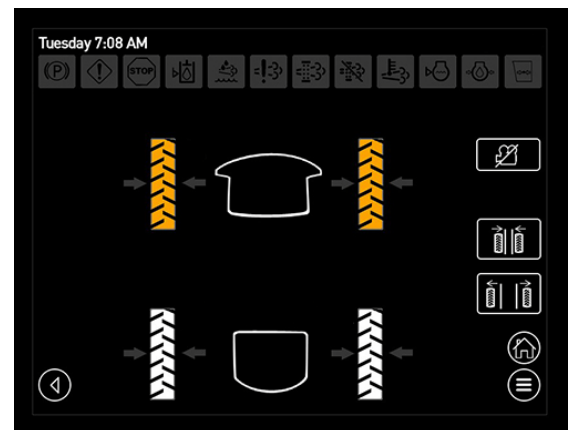

Refer to “Tread Adjustment - Hydraulic” provided in the *Hydraulic Systems Section* elsewhere in this manual for complete operating instructions and safety precautions.



Tread Button
(Located on the Main Menu Page)

Engine Diagnostics

- Press the Engine Button to navigate to the “Engine Diagnostics” screen.



Engine Button
(Located on the Main Menu Page)

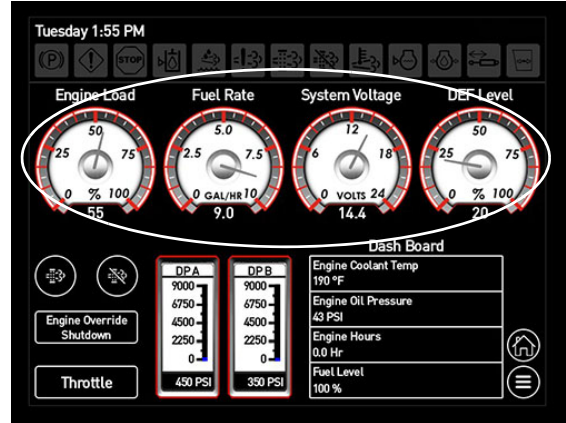

System Gauges
(Located on the Engine Diagnostics Screen)

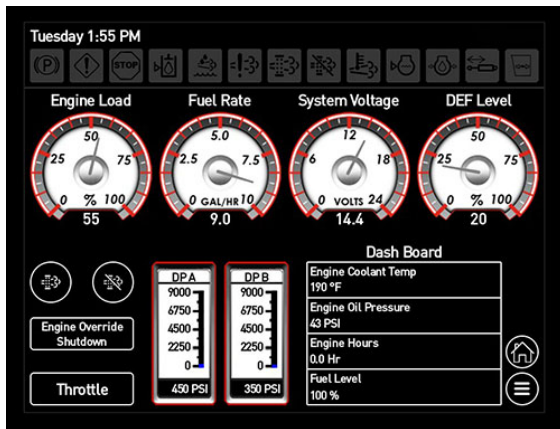

Engine Diagnostics Screen

NOTE: When battery voltage depletes to 11.7 volts and below, a warning message will appear alerting you of low battery voltage. The low voltage warning will disappear when voltage is greater than 12.5 volts.

System Diagnostics (Dash Board)

System Diagnostics may be viewed on the “Engine Diagnostics” screen. Such items include:

- Engine Coolant Temperature
- Engine Oil Pressure
- Engine Hours
- Fuel Level (percentage of full)

System Gauges

(Engine Load, Fuel Rate, System Voltage, and DEF Level)

Electronic System Gauges for Engine Load, Fuel Rate (gallons/liters per hour), System Voltage, and DEF Level are located on the “Engine Diagnostics” screen. Digital display indicators are located beneath each gauge.

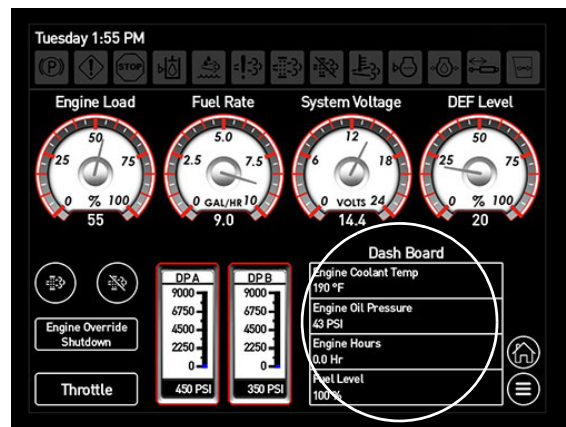

System Diagnostics
(Located on the Engine Diagnostics Screen)

Engine Coolant Temperature

The Engine Coolant Temperature is displayed on the “Engine Diagnostics” screen. If the engine coolant temperature reaches a level that is too high (greater than 220° F.), a warning message will appear and a red warning indicator lamp will illuminate along the top of any given display page. In addition, a warning alarm will sound.

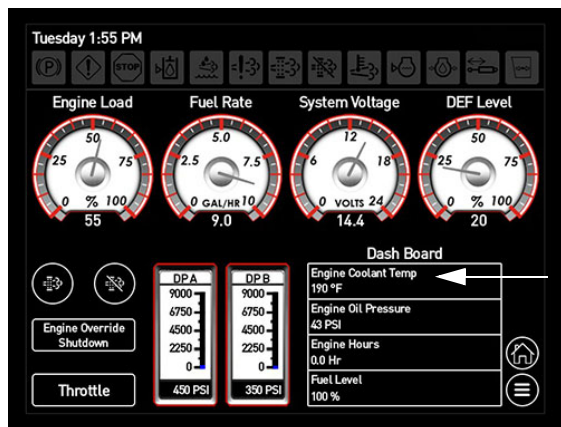

Engine Coolant Temperature
(Located on the Engine Diagnostics Screen)

NOTE: The warning alarm may be silenced by pressing the Sound Muted Button (Main Menu Page>Preferences).

If the engine temperature continues to rise after the initial warning message, a second warning message will appear shortly before the machine begins to go into protective mode, alerting you that the engine coolant temperature is too high and the engine will begin to de-rate. Press OK to acknowledge.

If this warning message appears, immediately reduce the engine speed and allow engine to idle. This will allow the cooling system to cool the engine down and prevent possible damage. Contact your local John Deere dealer if troubleshooting assistance is needed.

NOTE: When this warning message appears, the machine may be severely limited in engine and hydraulic functions (to prevent possible damage to those systems).

DP-A/DP-B Gauges

The DP-A and DP-B Gauges (located on the “Engine Diagnostics” screen) displays current drive pump pressure.

- **DP-A** (Drive Pump, Port A) - High in forward acceleration or reverse deceleration.
- **DP-B** (Drive Pump, Port B) - High in forward deceleration or reverse acceleration.

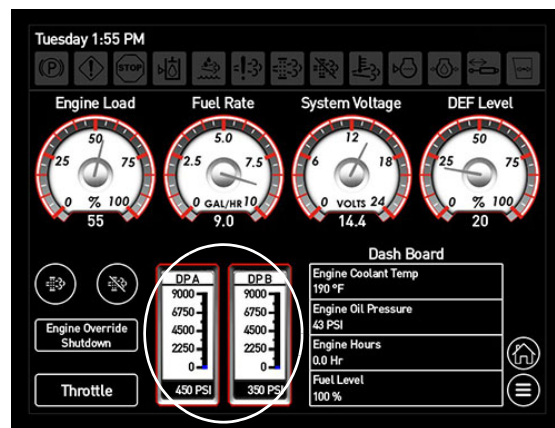

DP-A/DP-B Gauges
(Located on the Engine Diagnostics Screen)

Engine Override (Final Tier 4 engines)

NOTICE

The Engine Override feature is not intended as means of avoiding an engine shutdown for an extended period of time.

The Engine Override Shutdown Button (located on the “Engine Diagnostics” screen) allows the operator to continue running the engine for a calibrated time period in order to move the vehicle to a safe stopping location.

To Temporarily Avoid Engine Shutdown

- Press and hold the Engine Override Shutdown Button (located on the “Engine Diagnostics” screen) momentarily.

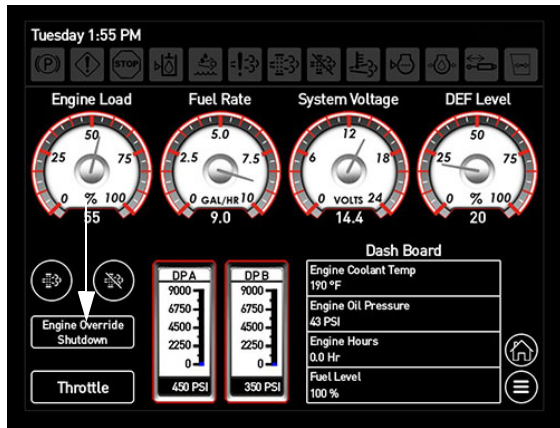

Engine Override Shutdown Button
(Located on the Engine Diagnostics Screen)

Refer to the engine manufacturer's operation manual for further information.

Engine Regeneration

(Manual Regen/Inhibit Regen)

The Manual/Inhibit Regen Buttons (located on the “Engine Diagnostics” screen) allow the operator to perform a manual engine exhaust system cleaning.

Refer to the “Engine Aftertreatment - Final Tier 4” information provided in the *Engine and Drive Systems Section* elsewhere in this manual for complete operating instructions and safety precautions.

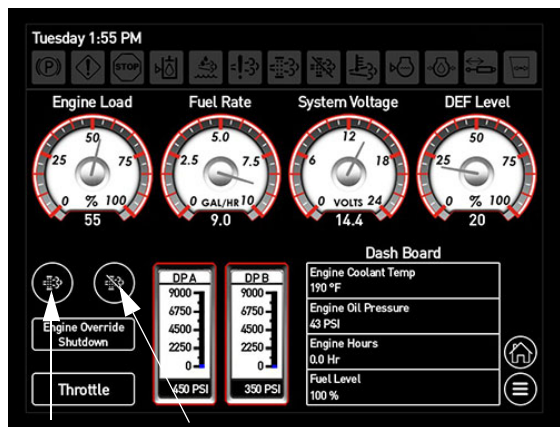

- Manual Regen
- Inhibit Regen

Manual/Inhibit Regen Buttons
(Located on the Engine Diagnostics Screen)

Engine Throttle

Throttle Control Slope

Determines how fast engine speed increases when the Throttle Switch (located near the Hydrostatic Drive Control Handle) is pressed in the UP (“rabbit icon”) position.

NOTE: Values are set as a percentage per second.

NOTE: If Throttle Control Slope is set at 25 percent per second and Throttle Max is set at 100 percent, Throttle Up Ramp should be at least four (4) seconds to achieve 100 percent throttle when operating the Throttle Switch.

Throttle Up Ramp

Amount of time engine speed will increase or decrease when the Throttle Switch (located near the Hydrostatic Drive Control Handle) is pressed up or down.

Throttle Max

Maximum percentage that engine speed will achieve (e.g. If Throttle Max is set at 100 percent, throttle control will set engine speed between 850 and 2300 RPM. If Throttle Max is set at 0 percent, maximum engine speed will be 850 RPM).

NOTE: Pressing the Throttle Switch (located near the Hydrostatic Drive Control Handle) in the UP (“rabbit icon”) position will not increase engine speed when Throttle Max is set at 0 percent.

To Change Throttle Setting Values:

- Press the Throttle Button (located on the “Engine Diagnostics” screen).

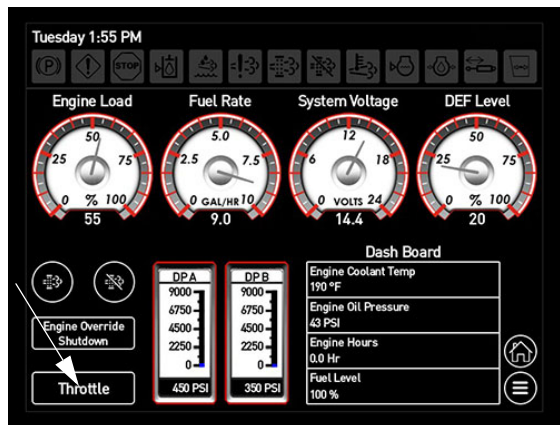

Throttle Button
(Located on the Engine Diagnostics Screen)

- On the “Throttle Settings” screen, use the slide bar to adjust desired throttle value.

NOTE: Slide right to increase value, or left to decrease value.

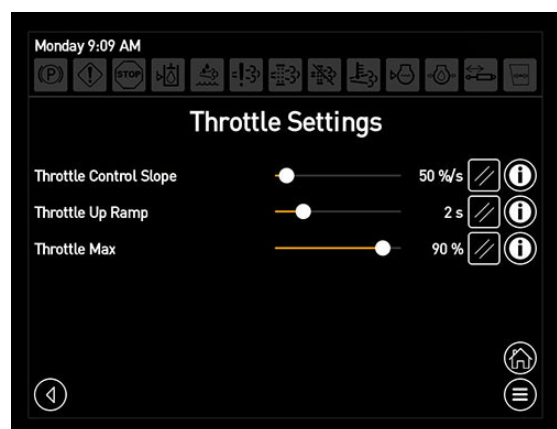

Throttle Settings Screen

- Press the Back Button to return to the previous screen.

Refer to “Hydrostatic Drive” provided in the *Engine and Drive Systems Section* elsewhere in this manual for further information.

Attachment

(Detasseler Tool Bar)

The Tasselrol™ XL Detasseling System is controlled through the Machine Display. The display is used for programming the detasseling heads to control tool bar

functions, such as Lift/Motor Control (Auto/ Manual Mode), Depth Command, Light Sensing, and Calibration.

Refer to “Tasselrol™ XL/LS System 12” provided in the *Detasseling Systems* section elsewhere in this manual for complete operating instructions.

Speed Settings

(Speed Ranges)

Your machine is featured with three speed ranges - Speed Range 1, Speed Range 2, and Speed Range 3. The Speed Range selected is displayed on the Home Page - Road and Field Mode.

NOTE: Speed Range 3 is available in Road Mode only. This range is always set to maximum speed and is non-adjustable.

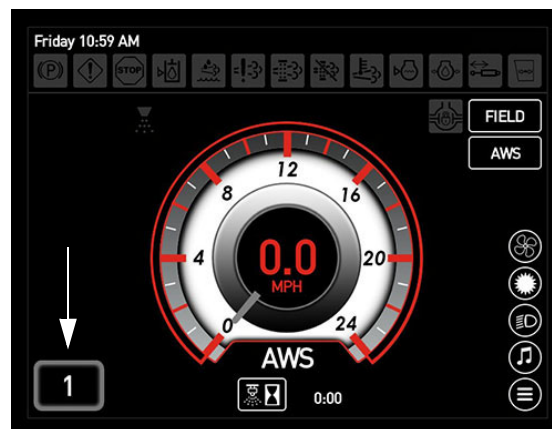

Speed Range
(Located on the Home Page - Road and Field Mode)

Refer to “Hydrostatic Drive” provided in the *Engine and Drive Systems Section* elsewhere in this manual for further information on the different speed ranges.

To Change Speed Range

NOTE: The Hydrostatic Drive Control Handle must be in the NEUTRAL position before changing Speed Range settings.

- Press the Speed Settings Button to navigate to the “Speed Settings” screen.

NOTE: You may also navigate to the “Speed Settings” screen by pressing the center of the speedometer on the Home Page.



Speed Settings Button
(Located on the Main Menu Page)

- On the “Speed Settings” screen, press the arrow button(s) (next to desired speed range) until desired speed is obtained.

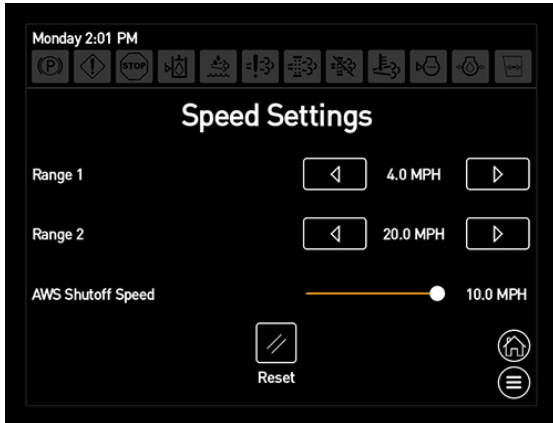

Speed Settings Screen

AWS Shutoff Speed

- Press the Speed Settings Button to navigate to the “Speed Settings” screen.
- NOTE: You may also navigate to the “Speed Settings” screen by pressing the center of the speedometer on the Home Page.*
- On the “Speed Settings” screen, use the slide bar to adjust to desired speed.

NOTE: Slide right to increase speed, or left to decrease speed.

Brightness Adjustment
(Day Time/Night Time)

To Adjust the Display, Side Console Switches, and Gauge Post Lighting

- Press the Brightness Button to navigate to the “Brightness” screen.

NOTE: You may also navigate directly to the “Brightness” screen by pressing and holding the Brightness Shortcut Button on the Home Page.



Brightness Button
(Located on the Main Menu Page)

- On the “Brightness” screen, press desired “Day Time” or “Night Time” Button.
- Use the slide bar to adjust desired brightness level.

NOTE: Slide right to increase brightness level, or left to decrease brightness level.

NOTE: The side console switches and gauge post do not have adjustable brightness settings. Slide the slide bar to the right to turn switch lighting ON, or to the left to turn switch lighting OFF.

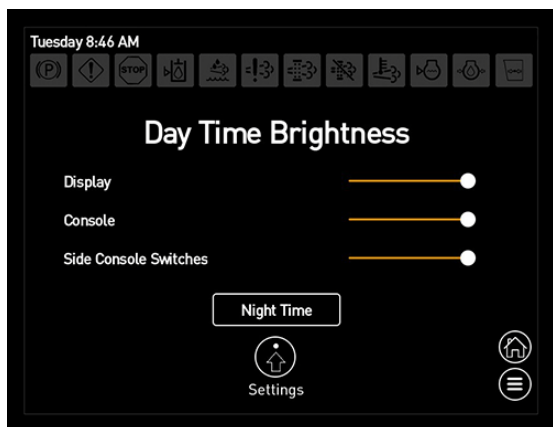

Brightness Screen

To Set Automatic Night Time/Day Time Transition Brightness

NOTE: Brightness levels must be manually set (as previously described) before setting automatic transition brightness.

- On the “Brightness” screen, press the Settings Button.
- On the “Transition Settings” screen, slide the ENABLE TIME TRANSITION slide bar to the right to enable.

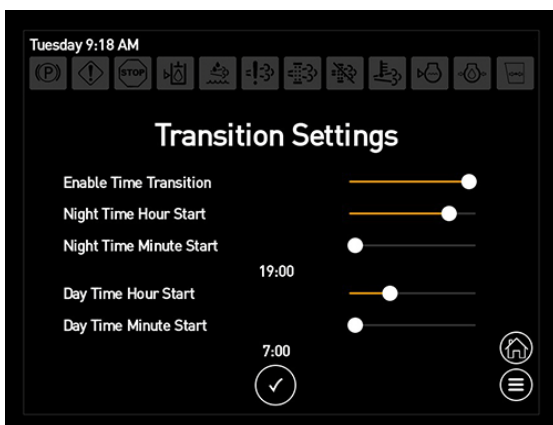

Transition Settings Screen

- Use the slide bar to adjust desired value (time of day that brightness level will activate) for either Night Time or Day Time Hour/Minute Start.

NOTE: Slide right to increase the amount of hours/minutes, or left to decrease the amount of hours/minutes.

- Press the Accept Button when finished.

End Row Management

The End Row Management Switch (located on the Hydrostatic Drive Control Handle) may be programmed for use of various functions, including All-Wheel Steer (if equipped), Auto Steer, and Main Control.

NOTE: End Row Management functions are disabled in Road Mode.

To Program the End Row Management Switch

- Press the End Row Management Button to navigate to the “Select Action to Program” screen.



End Row Management Button
(Located on the Main Menu Page)

- On the “Select Action to Program” screen, select the setting in which you wish to operate the End Row Management Switch (located on the Hydrostatic Drive Control Handle) - “Single Press” or “Press and Hold”.



Select Action to Program Screen

- On the “End Row Management Editor” screen, press the desired function you want to set (AWS - *if equipped*, Auto Steer, or Main Control).
- Press the “Delayed Time” cell next to the function you selected.
- Press the “+” or “-” Button to adjust to desired value - amount of time (seconds) from when the End Row Management Switch (located on the Hydrostatic Drive Control Handle) is pressed to when the function is engaged.

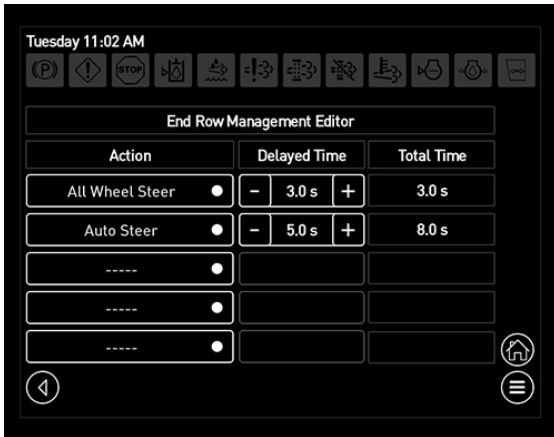

End Row Management Editor Screen

- Press the back arrow when finished.

Total Time

Displays the total time from when the End Row Management Switch is pressed until the action is commanded.

Example:

	Delayed Time	Total Time	Time from when ERM Button is pressed to engagement
1.	0	0	0
2.	0.5	0.5	0.5
3.	1.0	1.5	1.5
4.	0	1.5	1.5

Edit End Row Management Settings

- On the “Select Action to Program” screen, press the Settings Button.
- On the “End Row Management Settings” screen, use the corresponding slide bar to adjust value/setting (next to desired End Row Management setting).
 - *Pause Before Activate (seconds)*
 - *Display When Active (yes or no)*
 - *Enable Single Press (yes or no)*
 - *Enable Press and Hold (yes or no)*

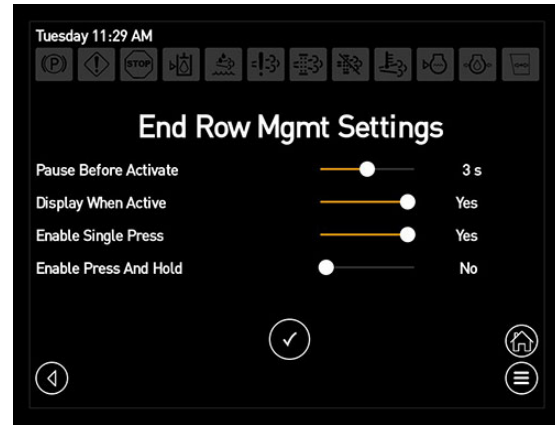

End Row Management Settings Screen

- Press the Accept Button when finished.

Reversible Fan

(Variable Pitch)

-If Equipped

To Activate the Reversible Fan

- Press the Fan Reverse Button to navigate to the “Engine Fan Control” screen.

NOTE: You may also navigate directly to the “Engine Fan Control” screen by pressing and holding the Fan Shortcut Button on the Home Page.



Fan Reverse Button
(Located on the Main Menu Page)

- On the “Engine Fan Control” screen, press the Reverse Button to turn the fan ON (reverse).

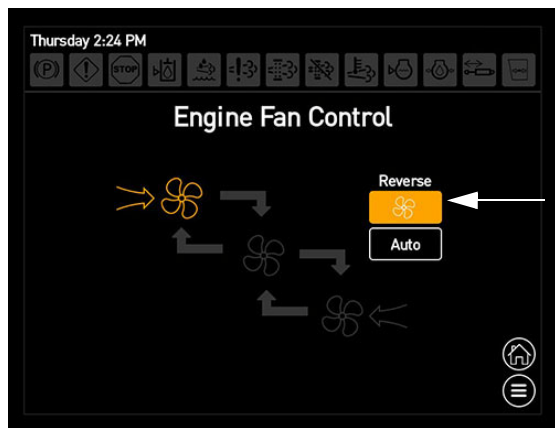

Reverse Button
(Located on the Engine Fan Control Screen)

NOTE: During the reverse cycle, the “Engine Fan Control” screen will display the current state of the reversible fan (airflow direction). The fan will automatically return to normal operation when the reverse cycle is complete.

Auto Fan Reversing

The Reversible Fan may be operated in Auto mode, which allows the operator to adjust the amount of time between automatic fan reversals.

To Enable Auto Fan Reversing

- On the “Engine Fan Control” screen, press the Auto Button.

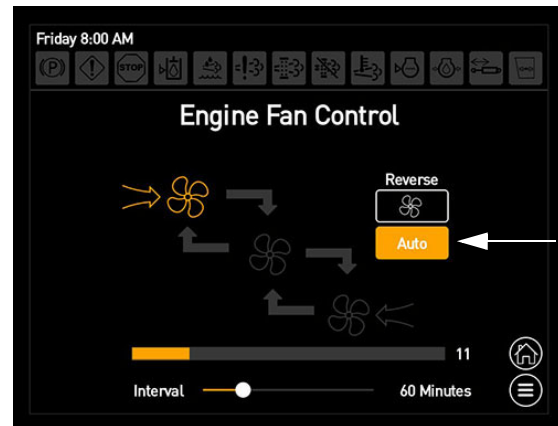

Auto Button
(Located on the Engine Fan Control Screen)

- Use the slide bar (next to Interval) and adjust to desired value (amount of time between automatic fan reversals).

NOTE: Slide right to increase time, or left to decrease time.

NOTE: Auto Fan Reverse interval range is between 10 and 240 minutes.

NOTE: A progress bar is located near the bottom of the screen to display the current number of minutes into the fan reversal process.

- Once the selected time interval has been reached, the Reverse Button will illuminate and the Auto Fan Reverse process will start over.

Refer to “Reversible Fan - Variable Pitch” provided in the *Hydraulic Systems Section* elsewhere in this manual for further information.

Camera (Rear-view)

- Press the Camera Button to navigate to the “Rear-view Camera” screen.

NOTE: You may also navigate to the “Rear-view Camera” screen through the Home Page - Road Mode.



Camera Button
(Located on the Main Menu Page)

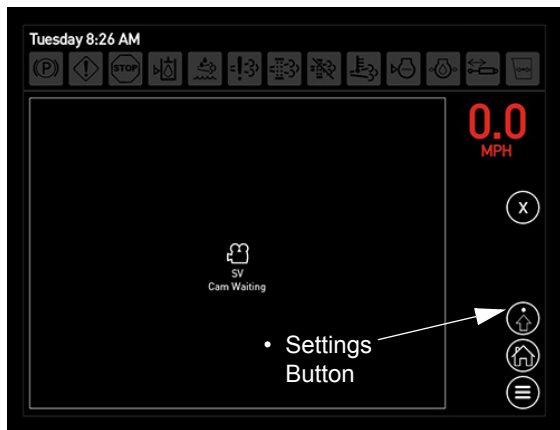

Rear-view Camera Screen

Rear-view Camera Settings

(Rear-view Camera in Reverse/Enable Camera in Road Mode)

NOTE: Rear-view Camera in Reverse feature resets to ON after ignition key cycle.

- On the “Rear-view Camera” screen, press the Settings Button.
- On the “Camera Settings” screen, use the corresponding slide bar to turn the “Rear-view Camera in Reverse” and/or “Enable Camera in Road Mode” option ON (Yes) or OFF (No).

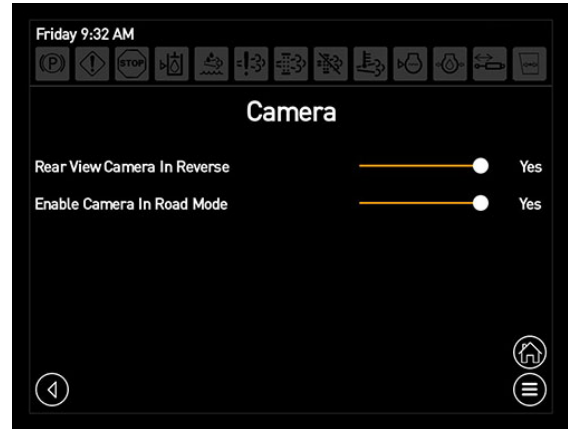

Camera Settings Screen

Multiple Rear-View Cameras

The Multiple Rear-View Camera feature allows the operator to install more than one camera on the machine. Press the corresponding camera image to view full screen of that camera.

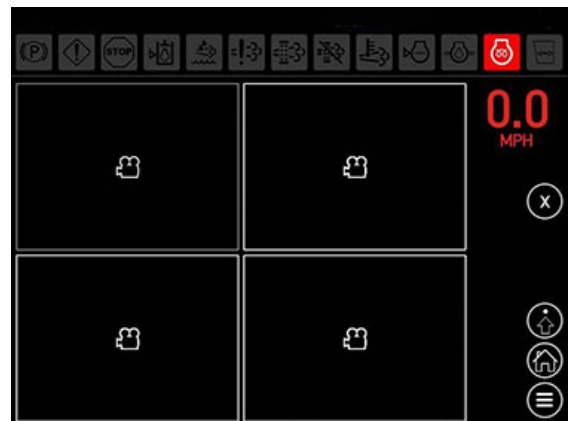

Multiple Rear-View Camera Screen

Audio

- Press the Audio Button to navigate to the “Audio” screen.



Audio Button
(Located on the Main Menu Page)

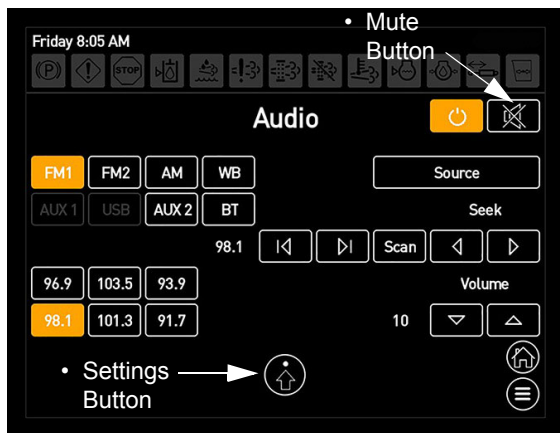

Audio Screen

Volume Buttons

- Press the Volume Button(s) to the right to increase sound level, or to the left to decrease sound level.

Mute Button

- Press the Mute Button to silence/mute stereo sound. Press again to resume sound.

Seek Buttons

- (1) - Press the Seek “Down” Button (left arrow with line) to shuffle to next tunable station.
- (2) - Press the Seek “Down” Button (left arrow) to shuffle one station/channel at a time.
- (3) - Press the Seek “Up” Button (right arrow) to shuffle one station/channel at a time.

- (4) - Press the Seek “Up” Button (right arrow with line) to shuffle to next tunable station.

Scan Button

- Press the Scan Button to seek the next tunable station, which will then pause on that station momentarily (approximately five seconds) before continuing on to the next station.

NOTE: Scanning will continue until it makes it back to the starting point, or if the Scan Button is pressed again, one of the other Seek Buttons is pressed, or the source is changed.

Power Button

- Press the Power Button to power the radio on. Press again to power the radio off.

NOTE: The Power Button will illuminate orange when on.

Source Buttons

(AUX1, USB, FM1, FM2, AM, Weatherband, AUX2, Bluetooth)

- Press the desired Source Button (AUX1, USB, FM1, FM2, AM, WB, AUX2, or BT) to navigate directly to that source.

NOTE: The selected source button will illuminate orange.

NOTE: AUX1 will be enabled if an aux input is inserted in the front aux port. USB will be enabled if a USB is inserted into radio.

Source Button

- Press the Source Button to toggle through source selections.

Preset Buttons

- Press and hold desired Preset Button to store the current radio station in that preset.
- Once set, press the desired Preset Button to navigate directly to the radio preset selection.

NOTE: The current radio station stored will be displayed on each button.

Audio Settings

(Balance, Bass, Middle, Treble)

- On the “Audio” screen, press the Settings Button to navigate to the “Audio Settings” screen.
- Use the slide bar (next to desired setting) to adjust desired level.

NOTE: Slide RIGHT to adjust right-side sound levels, or LEFT to adjust left-side sound levels.

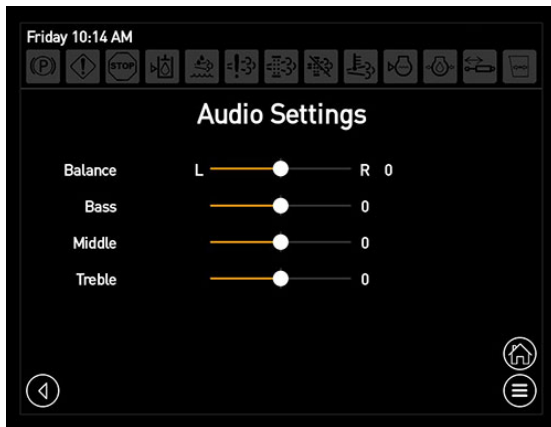

Audio Settings Screen

Audio Shortcut Button*

- Press the Audio Shortcut Button (located on the Home Page - Road or Field Mode) to silence/mute stereo sound. Press again to resume sound.
- Press and hold the Audio Shortcut Button to navigate to the Audio Screen.

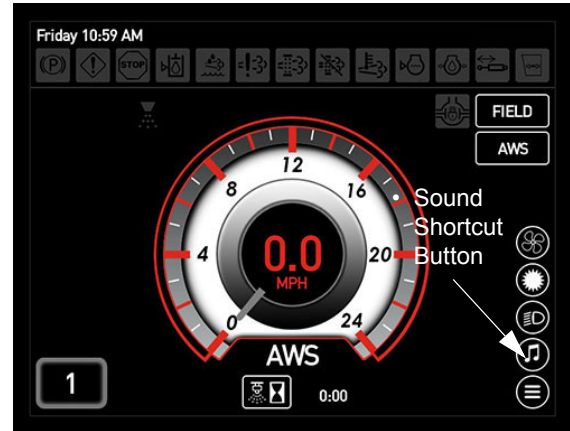

Audio Shortcut Button
(Located on the Home Page
- Road or Field Mode)

** Only displayed when the Show Shortcuts option is enabled through Display Preferences*

Machine Adjustments

The “Machine Adjustments” screen features various machine adjustments, such as:

- Tire Size
 - Service Intervals
 - Lock (Machine Security)
 - Machine Information
 - Adjust Time
- Press the Adjustments Button to navigate to the “Machine Adjustments” screen.



Adjustments Button
(Located on the Main Menu Page)

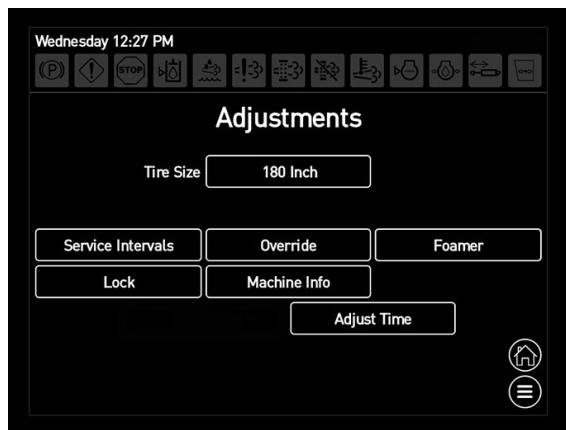

Machine Adjustments Screen

Tire Size

NOTE: Refer to “Tire Specifications” provided in the Introduction Section at the beginning of this manual for further information on tire options and rolling circumference values.

To Change Tire Size Value

- On the “Machine Adjustments” screen, press the cell next to “Tire Size”.
- Press the “+” or “-” button to enter the rolling circumference of the tires on your machine. Press center of cell again when finished.

NOTE: The operator may compare the displayed machine speed to the GPS speed and dial number in closer if desired.

Service Intervals

To Change Service Interval Settings

- On the “Machine Adjustments” screen, press the Service Intervals Button.
- On the “Service Intervals” screen, press the center of cell (to the far right) of the service interval you wish to change (Engine Oil, Hydraulic Filter, or Hydraulic Oil).

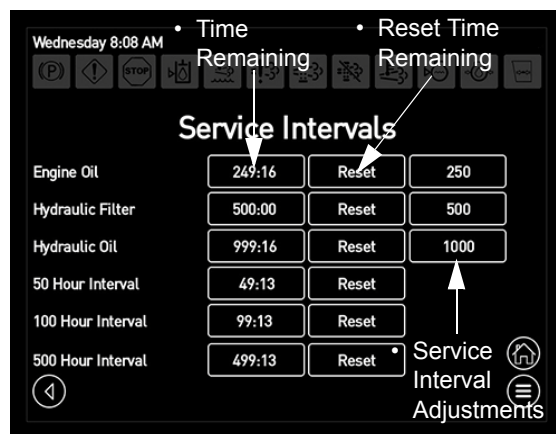

Service Intervals Screen

- Press the “+” or “-” Button(s) to adjust service interval to desired setting. Press the center of cell when finished.

NOTE: Service interval settings cannot be set above the maximum allowed time. Refer to the Maintenance and Storage Section elsewhere in this manual for further information.

NOTE: Press the Reset Button to set service interval back to factory setting.

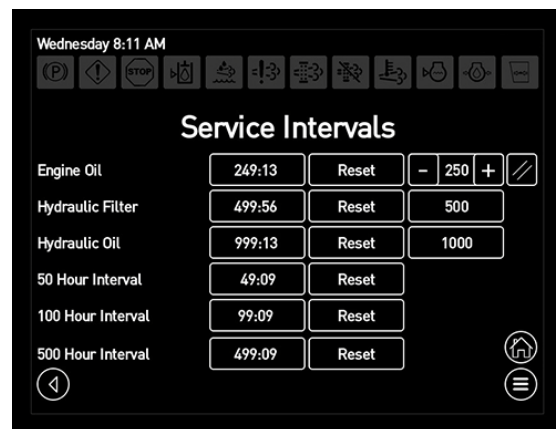

Service Intervals Screen

- Press the corresponding Reset Button to reset the time remaining.

Lock (Machine Security)

To Lock Machine Settings

- On the “Machine Adjustments” screen, press the Lock Button.

- On the “Change Locked Parameters” screen, select the setting(s) you wish to lock.

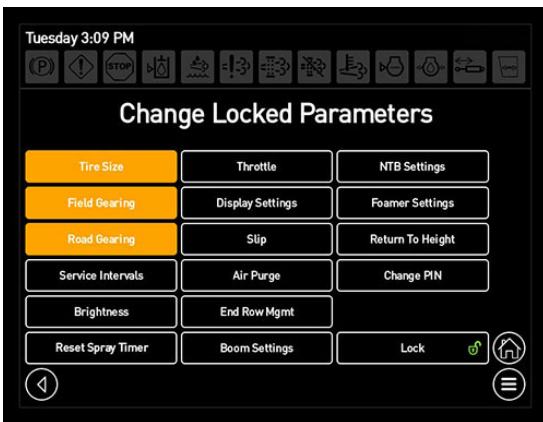

Change Locked Parameters Screen

- Press LOCK.
- Press OK to confirm lock.

To Unlock Machine Settings

NOTE: Default Pin Number is “50525”.

- On the “Change Locked Parameters” screen, press the Lock Button.

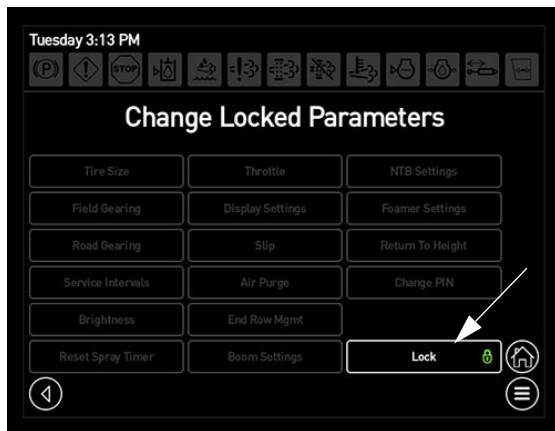

Lock Button

- On the “Password” screen, enter pin number.

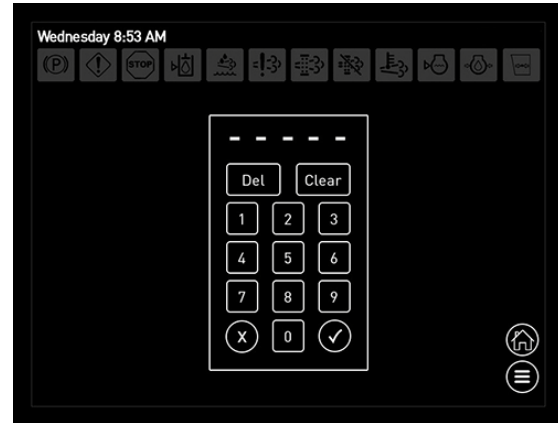

Password Screen

- Press the Accept Button when finished.

To Change Pin Number

- On the “Change Locked Parameters” screen, press the Change Pin Button.

NOTE: Press the Lock Button and enter current pin number to enable the Change Pin Button.

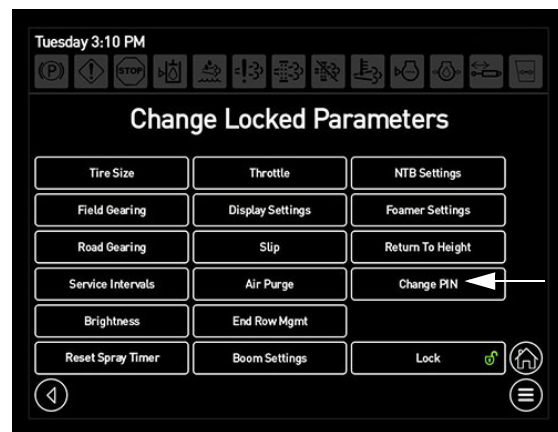

Change Pin Button

- On the “Password” screen, enter new pin number.
- Press the Accept Button when finished.

NOTE: A “Password Changed” confirmation will appear when complete.

Machine Information

- On the “Machine Adjustments” screen, press the Info Button to navigate to the “Machine Information” screen. There you will find machine information such as total engine hours, engine serial number,

software version, and attachment information.

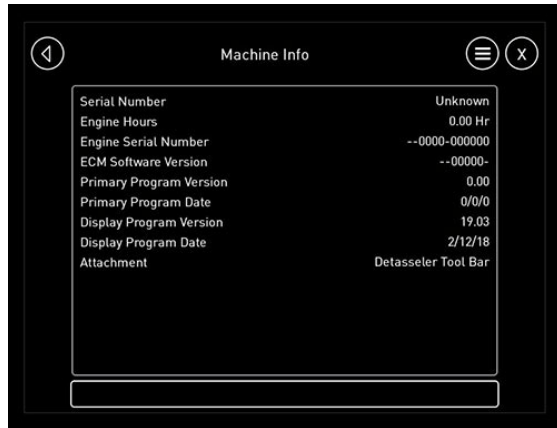

Machine Information Screen

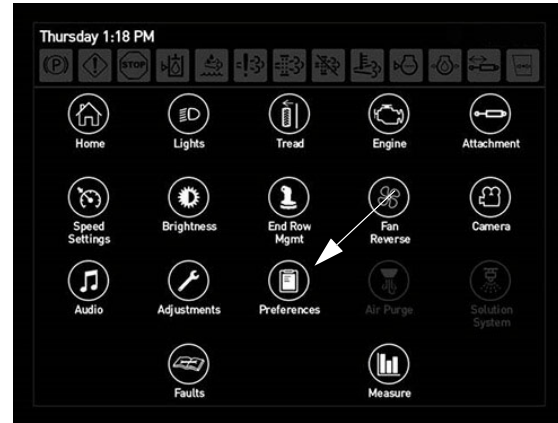

Preferences Button
(Located on the Main Menu Page)

Adjust Time

- On the “Machine Adjustments” screen, press the Adjust Time Button to navigate to the “Date/Time” screen. Modify the date/time as desired.

See “Date and Time” at the beginning of this section for further information.

Display Preferences

The “Display Preferences” screen features various display adjustments, such as:

- Gauge Color
- Animations
- Units (Standard, KPA, Bar)
- Date
- Time Format
- Sound Muted
- Language
- Show Shortcuts (“Quick Keys” - Home Page)
- Press the Preferences Button to navigate to the “Machine Preferences” screen.

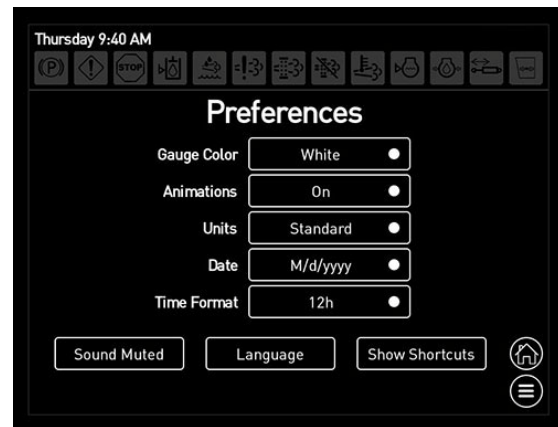

Display Preferences Screen

Gauge Color

- On the “Preferences” screen, press the cell next to “Gauge Color” and select desired speedometer color (white, red, yellow, or black).

Animations

- On the “Preferences” screen, press the cell next to “Animations” and select ON to enable animations, or OFF to disable animations.

Units

- On the “Preferences” screen, press the cell next to “Units” and select desired units of measure to be displayed - Standard, Metric (KPA), or Metric (Bar).

Date

- On the “Preferences” screen, press the cell next to “Date” and select desired date format to be displayed (m/d/yyyy or d/m/yyyy).

Time Format

- On the “Preferences” screen, press the cell next to “Time Format” and select desired time format to be displayed - 12 hour (AM/PM) or 24 hour.

Sound Muted

- On the “Preferences” screen, press the Sound Muted Button to silence audible warning alarms.

NOTE: The Sound Muted Button resets to OFF when the ignition key is cycled.

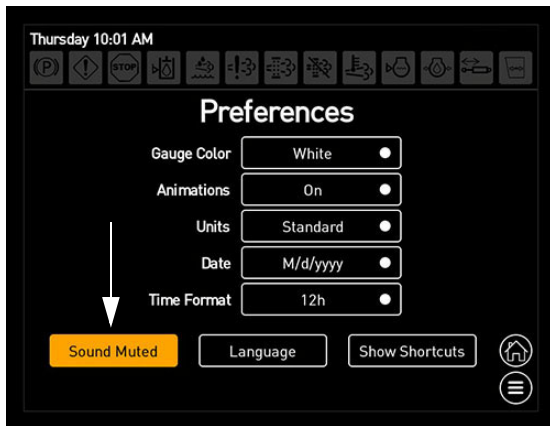

Sound Button
(Located on the Preferences Screen)

Language

- On the “Preferences” screen, press the Language Button.
- On the “Language” screen, select desired language.

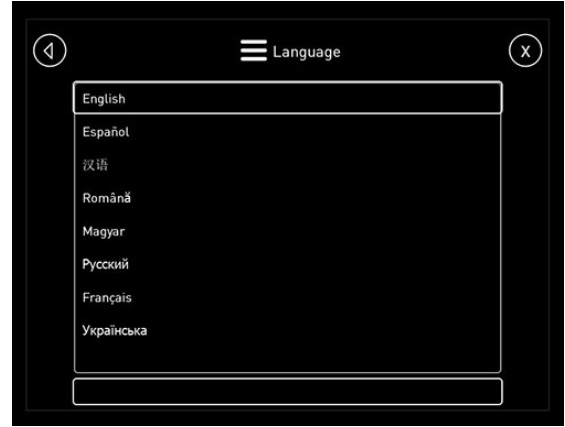

Language Screen

Show Shortcuts

(“Quick Keys” - Home Page)

The four hidden “Quick Keys” are located on the Home Page - Road/Field Mode and allow the operator to turn frequently used features on/off conveniently from the Home Page.



• Reversible Fan Quick Key



• Day Time/Night Time Brightness Quick Key



• Exterior Lights Quick Key



• Audio Quick Key

- On the “Preferences” screen, press the Show Shortcuts Button to enable (unhide) the four Quick Keys located on the Home Page - Road/Field Mode. Press button again to disable (hide) the Quick Keys.

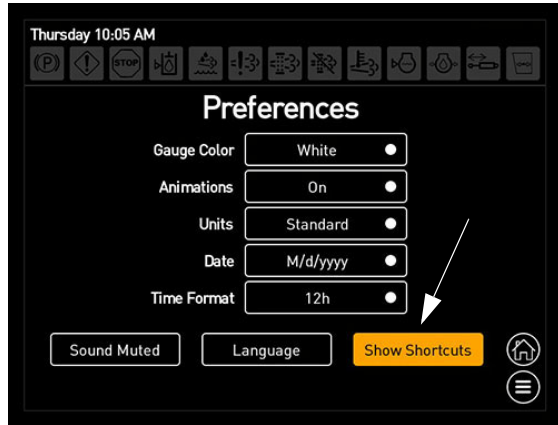

Show Shortcuts Button
(Located on the Preferences Screen)



Faults Button
(Located on the Main Menu Page)

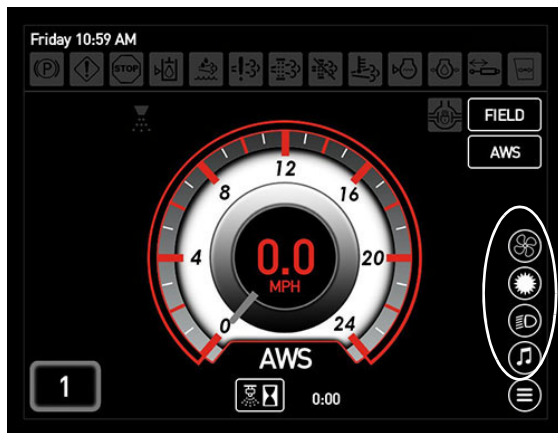

Quick Keys
(Located on the Home Page
- Road and Field Mode)

- Press the desired Quick Key to turn feature ON. Press again to turn feature OFF.
- Press and hold the desired Quick Key to navigate directly to that system's display page.

System Faults

The "System Faults" screen displays various machine faults, such as:

- Primary
- Secondary
- Display
- Engine
- Attachment

- Press the Faults Button to navigate to the "System Faults" screen.

- On the "System Faults" screen, press desired fault button to navigate to the corresponding fault screen, which will display the fault code and fault description.

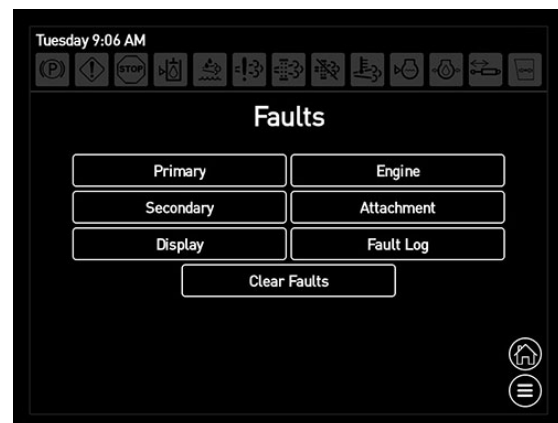

System Faults Screen



Secondary Faults Screen

Active Faults

When a system fault occurs, a warning message will appear on any given display page, which will inform you of the fault code and the reason for the fault. Press OK to acknowledge.

NOTE: Each Active Fault will display the fault code and description. Refer to fault code when speaking with your local John Deere dealer.

In the event that a severe system malfunction should occur and cause the machine to operate outside of normal operating conditions (i.e. All-Wheel Steer fault, tire size not selected, etc.), a Machine Malfunction Warning message will appear on the display. This warning message will inform you that a malfunction was detected and that the machine is not responding normally and you must operate with extreme caution, as machine speed will be limited and stopping distance may be increased or decreased. Press OK to acknowledge.

In addition, a second warning message will appear informing you of the specific fault description. Contact your local John Deere dealer for assistance.

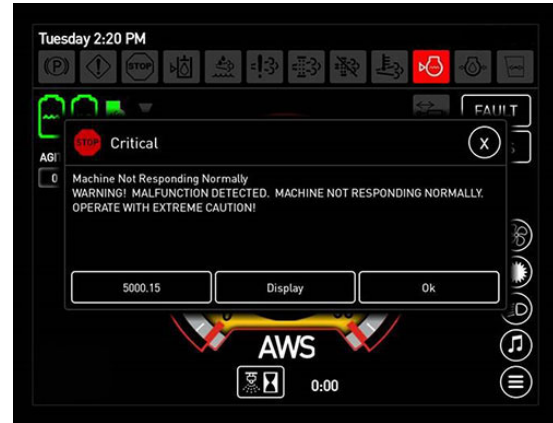

Machine Malfunction Warning

Fault Log

- On the “System Faults” screen, press the Fault Log Button.

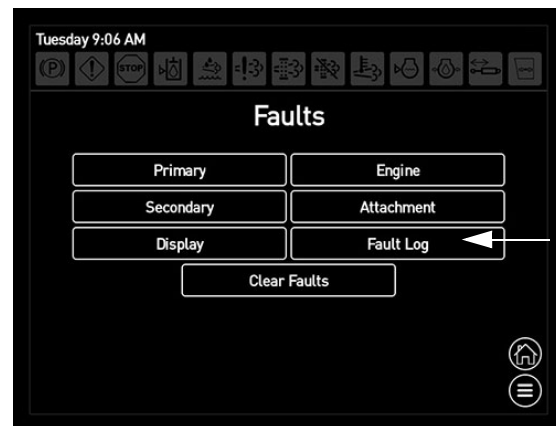

Fault Log Button
(Located on the System Faults Screen)

- On the “Faults” screen, you will be able to view all previous system faults.

NOTE: System faults are listed with the most current fault at the top of the screen. Swipe the screen up or down to scroll through faults.

⚠ CAUTION

Machine speed will be limited and stopping distance may be increased or decreased following a machine fault warning.

⚠ CAUTION

Do not operate the machine following a machine fault warning. Failure to comply may result in personal injury and machine damage.



Faults Screen

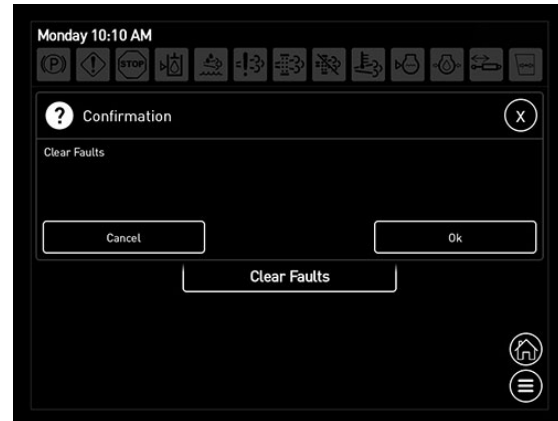

Clear Faults Confirmation

Clear Faults

- On the “System Faults” screen, press the Clear Faults Button to remove faults after the fault issue has been resolved.

NOTE: System Faults will continue to appear until the fault issue has been resolved, regardless of clearing the faults.

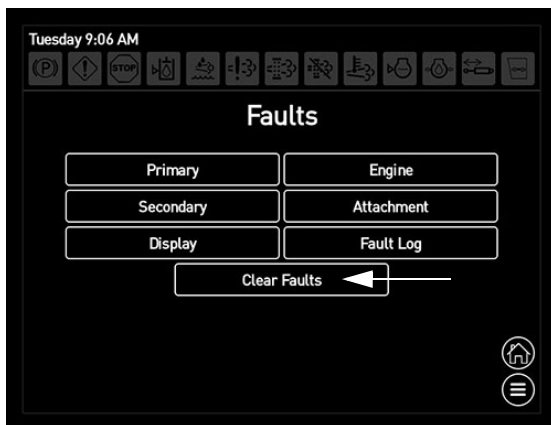

Clear Faults Button
(Located on the System Faults Screen)

NOTE: A “Clear Faults Confirmation” message will appear. Press OK to confirm.

Measure

While either parked or operating the machine, current system measurements can be viewed when diagnosing or troubleshooting.

- Press the Measure Button to navigate to the “Measurements” screen.

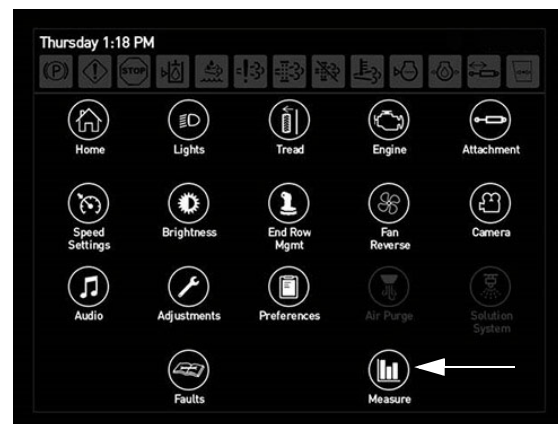

Measure Button
(Located on the Main Menu Page)

- On the “Measurements” screen, select desired system to view current system status.

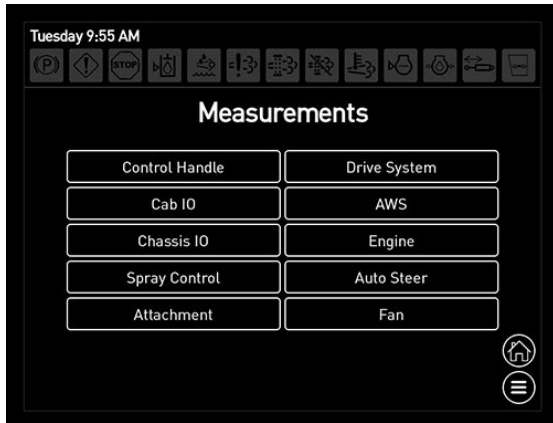

Measurements Screen

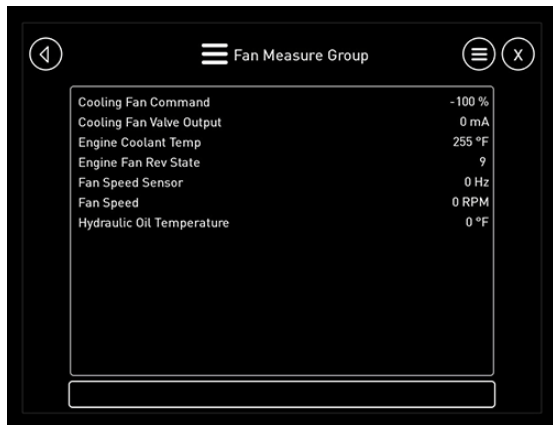

System Status Screen



SECTION 4 – ENGINE AND DRIVE SYSTEMS

ENGINE - STARTING

CAUTION

Start engine from the operator's seat only. When running the engine in a building, ensure there is adequate ventilation.

NOTE: An Insufficient Cab Air Pressure Indicator will appear on the Machine Display Home Page - Road or Field Mode each time the machine is started, due to a slight activation delay of the RESPA® Cab Filtration System. The indicator will disappear once the cab becomes pressurized.

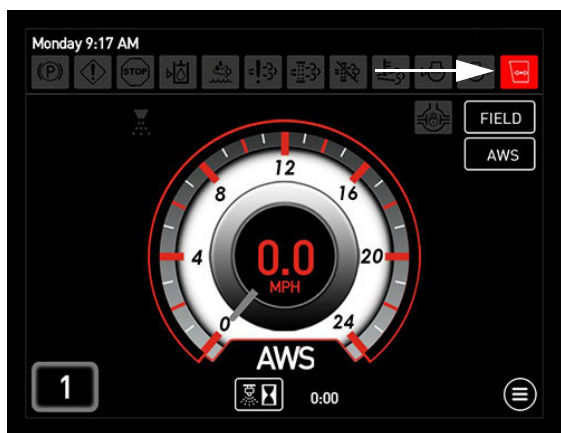

Insufficient Cab Air Pressure Indicator
(Located on the Machine Display Home Page - Road or Field Mode)

Pre-Operational Checklist

1. Check engine oil level.

NOTE: Do not operate the machine when oil level is below the "L" (low) mark or above the "H" (high) mark on the engine oil dipstick.

2. Check coolant level.

3. Check diesel exhaust fluid level (Final Tier 4 engines only).
4. Check hydraulic reservoir oil level.
5. Check cooling air intake screen.
6. Drain fuel/water separator.
7. Check engine drive belt.
8. Check for any oil or fuel leaks.

Cold Start Procedure

1. Engage the parking brake.

NOTE: Refer to "Hydrostatic Drive" provided elsewhere in this section for further information.

2. Turn the Ignition ON, but DO NOT engage the starter. **(Wait for the Grid Heater ON indicator to disappear on the Machine Display).**

The following warning message will appear on the Machine Display during cold weather conditions. Press OK (acknowledging that you understand the engine requires a warm-up period before engaging the starter).

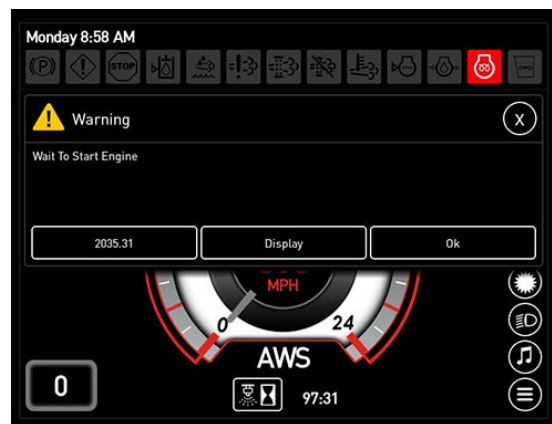

NOTE: Ensure that there are no other warnings before proceeding.

3. Engage the starter.
(If the engine fails to start after 15 seconds, turn the key OFF, wait one minute, and repeat the procedure. If the engine does not start after three attempts, check the fuel supply system).

4. Observe warning lights on the Machine Display (after start-up).

NOTE: If any functions do not operate, shut the engine OFF and determine cause.

5. Allow a warm-up period of at least five (5) minutes before operating the engine at a high RPM.

NOTE: The engine must reach operating temperature and oil pressure must stabilize in the normal operating range before it is run faster than idle speed (1,000 RPM or less).

6. Disengage the parking brake.

Jump Starting

1. Engage the parking brake.
2. Rotate the Battery Disconnect Switch (located on the rear mainframe) to the ON position.

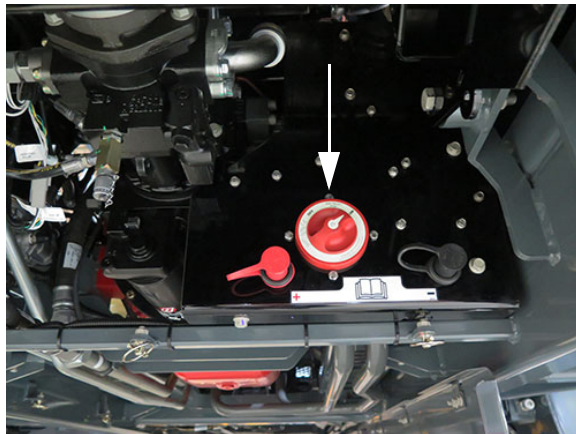

Battery Disconnect Switch
(Located on the rear mainframe)
-Typical View

3. Remove caps from the Auxiliary Battery Charging Posts (located on the rear mainframe).



Auxiliary Battery Charging Posts
(Located on the rear mainframe)
-Typical View

4. Connect cables from charging device (i.e. battery charger or another machine) to the Auxiliary Battery Charging Posts - positive cable to the positive terminal, and negative cable to the negative terminal.
5. Allow batteries to charge approximately 5-10 minutes.

NOTICE

Do not over-crank the starter. Failure to comply may result in starter damage.

6. Engage the starter by starting the machine.
7. Remove the charging cables in reverse to the way you attached them (negative cable first, then positive cable).

NOTE: Ensure that the charging cables do not touch together or to any metal surface.

8. Reinstall the Auxiliary Battery Charging Post caps.
9. Allow engine to idle for approximately 5 minutes to recharge the batteries.

NOTE: Longer idle time may be required, depending on how depleted the batteries are.

**ENGINE
AFTERTREATMENT - FINAL
TIER 4**

⚠ WARNING

It is unlawful to tamper with or remove any component of the Aftertreatment System. It is also unlawful to use Diesel Exhaust Fluid (DEF) that does not meet the specifications provided or to operate the machine with no DEF.

⚠ WARNING

DEF contains urea. Do not get the substance in your eyes. In case of contact, immediately flush eyes with large amounts of water for a minimum of 15 minutes. Do not swallow internally. In the event the DEF is ingested, contact a physician immediately.

⚠ WARNING

Read the DEF manufacturer's label and comply with safety precautions to avoid injury or damage.

⚠ CAUTION

Never attempt to create DEF by mixing agricultural grade urea with water. Agricultural grade urea does not meet the necessary specifications required and the Aftertreatment System may be damaged.

⚠ CAUTION

Aftertreatment DOC and DRT components may be hot. Allow engine to cool before handling. Failure to comply may result in injury.

⚠ CAUTION

Never add water or any other fluid besides what is specified to the DEF tank. Failure to comply may result in Aftertreatment System damage.

⚠ CAUTION

Do NOT add any chemicals/additives to the DEF in an effort to prevent freezing. If chemicals/additives are added to the DEF, the Aftertreatment System may become damaged.

⚠ CAUTION

When performing a stationary exhaust system cleaning, ensure the exhaust pipe outlet is not directed at any surface or material that may become hazardous.

NOTICE**USE CORRECT FLUID TYPES**

- Use only low-ash diesel engine oil.
- Use only ultra-low sulfur diesel (ULSD) fuel.
- Use only DEF meeting ISO 2224101 standards.

Failure to use the required fluid types will result in engine damage and will void the warranty.

NOTICE

Never operate the engine with low DEF level.

NOTICE

Do not direct water into exhaust opening. Failure to comply may result in system damage and will void the warranty.

NOTICE**DEF CAN BE CORROSIVE TO CERTAIN MATERIALS**

- Use only approved containers to transport or store DEF (polyethylene and polypropylene containers recommended).
- If DEF is spilled, rinse and clean immediately with water.
- Avoid contact with skin. If contact occurs, wash off immediately with soap and water.

NOTICE

Wipe up spills immediately with clean water. If DEF is left to dry, a white residue will remain. Failure to clean spilled DEF appropriately may result in an incorrectly diagnosed leak of the DEF Dosing System.

NOTICE

Thoroughly wash any containers, funnels, etc. that will be used to dispense, handle, or store DEF. **Rinse with distilled water only.** Use of tap water to rinse components will contaminate the DEF.

NOTICE

If incorrect fluid is mistakenly added to the DEF tank (e.g. water, diesel fuel, hydraulic oil, engine coolant, windshield washer fluid, etc.), contact the engine manufacturer to determine the appropriate repair.

The Final Tier 4 diesel engine is featured with a flow-through exhaust Aftertreatment System that delivers ultra-low emissions for cleaner air quality.

NOTE: When the ignition key is turned to the OFF position, DEF returns to the DEF tank.

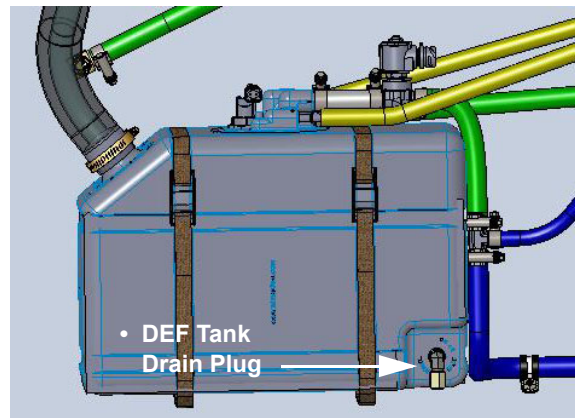
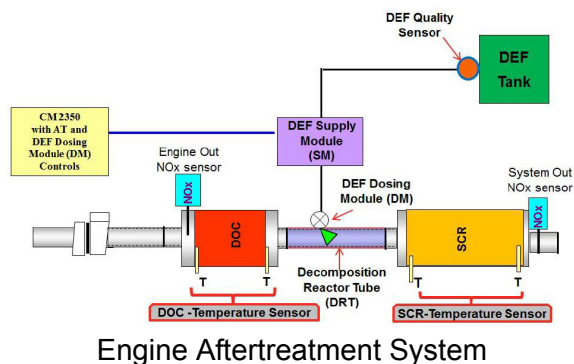

Aftertreatment System Components

- Final Tier 4 Diesel Engine
- Diesel Exhaust Fluid (DEF) Tank
- Diesel Exhaust Fluid (DEF) Gauge
- Diesel Oxidation Catalyst (DOC)
- Decomposition Reactor Tube (DRT)
- Selective Catalytic Reduction (SCR)
- DEF Dosing Module
- DEF Supply Module
- DEF Supply Module Filter
- DEF Quality Sensor
- DEF Suction Strainer

Final Tier 4 Diesel Engine

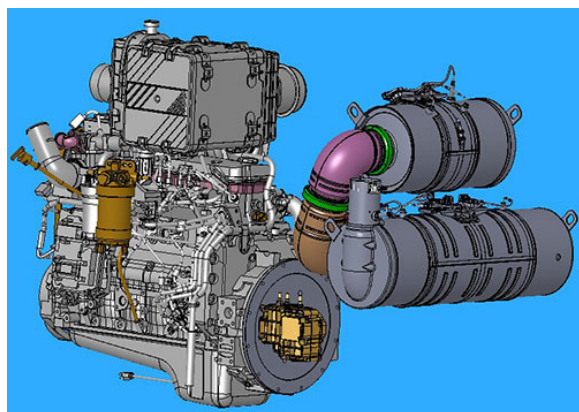

DEF Tank

- DEF Tank Capacity = 5 Gallons (18.9L)

DEF (Diesel Exhaust Fluid)

DEF is used in Selective Catalyst Reduction (SCR) Systems to help convert nitrogen oxide (NOx) emissions in engine diesel exhaust into harmless nitrogen and water vapor.

NOTE: Check DEF level daily.

Fluid Type:

- Use only DEF which meet ISO 2224101 standards.

NOTE: John Deere Diesel Exhaust Fluid recommended.

Fluid Storage:

- Store DEF between 23° F (-5° C) and 77° F (25° C).
- Refer to “Service - Fluids” provided in the *Maintenance and Storage Section* elsewhere in this manual for additional information.

Fluid Disposal:

- Check with local authority regulations on proper DEF disposal requirements.

DEF Gauge

The DEF Gauge (located on the cab A-post and on the Machine Display “Engine Diagnostics” screen) allows the operator to view current DEF tank level at all times.



DEF Gauge
(Located on cab A-post)
-Typical View

SCR (Selective Catalytic Reduction)

The SCR is where the DEF reduces gaseous nitrogen oxide (NOx) to near zero levels by converting into nitrogen gas and water vapor.

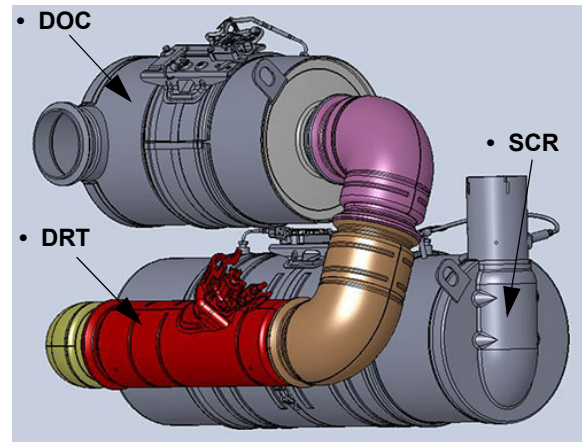

-Typical View

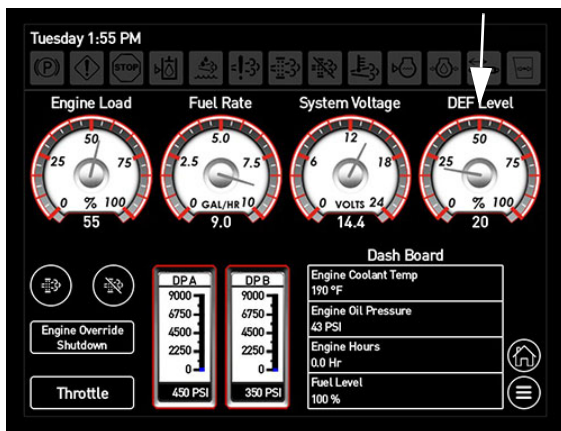

DEF Gauge
(Located on the Machine Display -
Engine Diagnostics Screen)
-Typical View

DEF Dosing Module

The DEF Dosing Module allows a fine mist of DEF to be sprayed into the hot exhaust.

DEF Supply Module

The DEF Supply Module pumps DEF from the tank to the Dosing Injector (located in the DRT).

DEF Supply Module Filter

The DEF Supply Module Filter (located beneath rear of machine) filters DEF before going to the Dosing Injector. Change filter every 4,500 hours of operation or every 3 years, whichever occurs first.

NOTE: Refer to the engine manufacturer's operation manual for further information.

DOC (Diesel Oxidation Catalyst)

The DOC reduces carbon monoxide and hydrocarbons produced by the engine.

DRT (Decomposition Reactor Tube)

The DRT is a mixer tube where DEF is injected and mixes with exhaust from the diesel engine, which is then converted into ammonia.

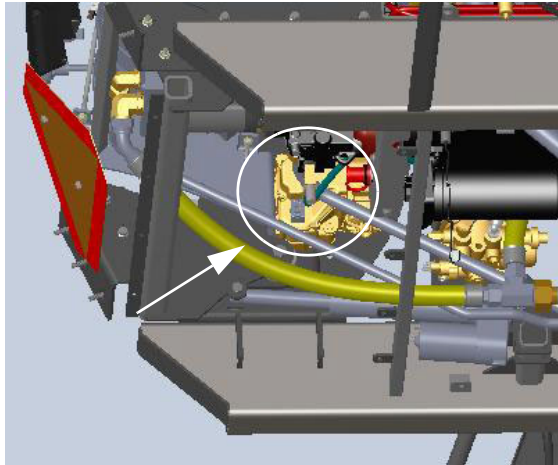

DEF Supply Module Filter
(Located beneath rear of machine)
-Typical View

* Rear underside of machine shown

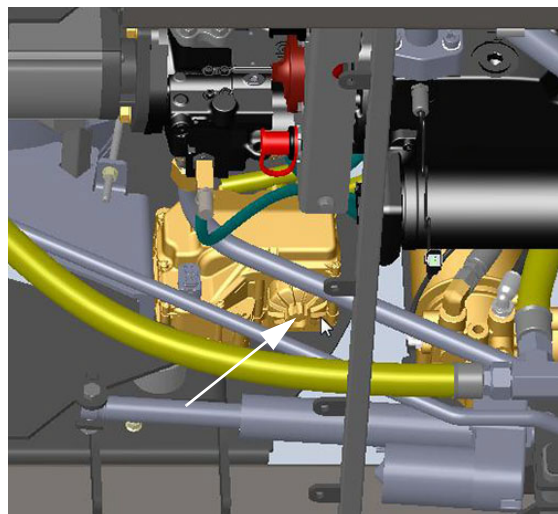

DEF Supply Module Filter
(Closeup View)

to drain sediment from tank. Remove and clean Suction Strainer, ensuring the strainer is reinstalled correctly when finished.

NOTE: Flush DEF Tank and components with distilled water only to remove any contamination. Refer to the engine manufacturer's operation manual for further information.



DEF Suction Strainer
(Located near bottom of the DEF Tank)
-Typical View

DEF Quality Sensor

The DEF Quality Sensor (located inside the tank) detects DEF tank level, as well as quality and temperature of the DEF, which are required for the Aftertreatment System to function properly.

DEF Suction Strainer

The DEF Tank is equipped with a Suction Strainer (located near bottom of tank). If degraded system performance occurs, remove drain plug (located at bottom of tank)

Filling the DEF Tank

DEF Indicator Lamps (Located on the Machine Display)



- **DEF Indicator Lamp** - Illuminates when the DEF level is low, and flashes when the DEF falls below a very low level. Operator should refill the DEF tank with DEF.



- **Flashing DEF Indicator Lamp with Check Engine Indicator Lamp** - Illuminates when the DEF level is critically low. If the tank is not refilled immediately, power will be reduced. Operator should refill the DEF tank with DEF. Normal engine power will be restored after the DEF tank is refilled.



FLASHING



- **Flashing DEF Indicator Lamp with Stop Engine Indicator Lamp** - Illuminates when the DEF gauge reads zero. Power will be reduced or limited to idle. Operator should stop the machine when it is safe to do so and refill the DEF tank. Normal engine power will be restored once the DEF tank is refilled.

1. Shut the engine OFF.
2. Remove the DEF Fill Cap (located on left-hand side of hood) and set aside.



DEF Fill Cap
(Located on left-hand side of hood)
-Typical View

3. Fill tank with DEF.
4. Reinstall the DEF Fill Cap.

NOTE: Refill tank with DEF every other fuel fill.

Stationary Exhaust System Cleaning

Your Final Tier 4 diesel engine requires little or no operator interaction. Under certain circumstances, an operator-initiated Exhaust System Cleaning may be required. Exhaust System Cleaning Indicator Lamps (located on the Machine Display) will illuminate to show system status.

Exhaust System Cleaning Indicator Lamps

(Located on the Machine Display)



- **High Exhaust System Temperature (HEST) Indicator Lamp** - May illuminate due to higher than normal exhaust temperature during Exhaust System Cleaning. Operator should ensure that the exhaust pipe outlet is not directed at any flammable or combustible surfaces.



- **Exhaust System Cleaning Indicator Lamp** - Illuminates when the exhaust system is unable to complete an automatic Exhaust System Cleaning event. Operator should ensure that the Exhaust System Cleaning Switch is not in the STOP position and continue working until there is an opportunity, such as at the end of the work day or shift to complete a stationary Exhaust System Cleaning.



- **Exhaust System Cleaning Indicator Lamp with Check Engine Indicator Lamp** - If an Exhaust System Cleaning is not performed in a timely manner after the Exhaust System Cleaning Indicator Lamp is illuminated, the Check Engine Indicator Lamp will illuminate and engine power will be significantly reduced. Park the machine when safe to do so and press the Exhaust System Cleaning Start Switch. Once cleaning is complete, full engine power will be restored.



- **Exhaust System Cleaning Indicator Lamp** - Flashes when a stationary Exhaust System Cleaning event is initiated using the Exhaust System Cleaning Start Switch. This lamp will continue to flash until the stationary cleaning event is complete. Once the lamp turns off, the operator can resume normal operation.



- **Exhaust System Cleaning Stop Indicator Lamp** - Illuminates when the Exhaust System Cleaning Switch is in the STOP position, preventing a cleaning event. This switch should be used only when high exhaust temperatures present a hazard. Excessive use of the Exhaust System Cleaning Switch in the STOP position will result in the need for more frequent stationary exhaust cleaning events.



- **Stop Engine Indicator Lamp** - Illuminates when continued operation could result in damage to the exhaust system. Shut down the engine as soon as it is safe to do so and call for service to avoid damage to the exhaust system.

To Perform an Exhaust System Cleaning

1. Park the machine in a safe location where the exhaust pipe outlet will not face any combustible surface.
2. Engage the parking brake.
3. With the engine running and at idle, press the Manual Regen Button (located on the Machine Display - “Engine Diagnostics” screen).

NOTE: When the cleaning event is activated, engine speed may increase and the HEST Indicator Lamp (located on the Machine Display) may illuminate and the Exhaust System Cleaning Indicator Lamp will flash.

4. Monitor the machine and surrounding area for safety.

NOTE: If the machine needs to be used or moved, stop the stationary cleaning event by increasing the Throttle Switch (located near the Hydrostatic Drive Control Handle).

5. When the Exhaust System Cleaning is complete, the engine will return to normal idle speed and the HEST and Exhaust System Cleaning Indicator Lamps will turn off.

Further Information

Refer to the *Maintenance and Storage Section* provided elsewhere in this manual for additional Aftertreatment service and maintenance information.

Refer to the engine manufacturer's operation manual for complete operating instructions and safety precautions.

HYDROSTATIC DRIVE

The Hydrostatic Drive System uses pressurized hydraulic fluid to drive the machine. The Hydrostatic Drive System consists of four components: Diesel Engine, Hydrostatic Pump, Wheel Motors, and Wheel Hubs.

Hydrostatic Drive Components

- Cummins® Diesel Engine
- Hydrostatic Pump
- Wheel Motors (4)
- Wheel Hubs (4)

Engine and Hydrostatic Pump

Your machine is featured with a Cummins diesel engine (located beneath the rear hood). The engine has a direct-mounted Hydrostatic Pump (located near center of machine).

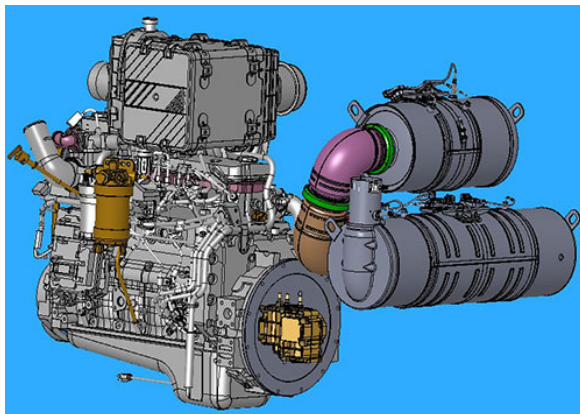

Final Tier 4 Diesel Engine
-Typical View

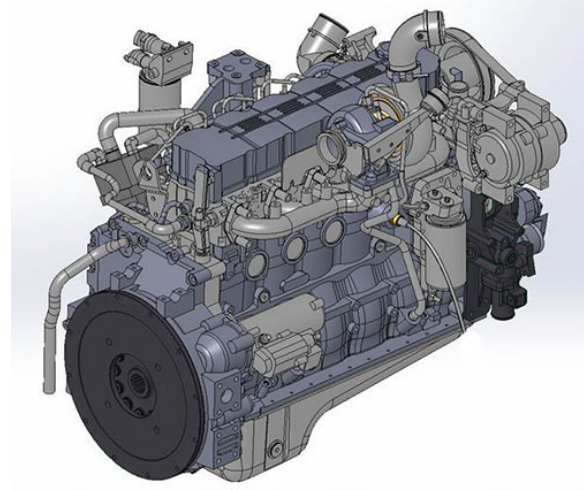

Tier 3 Diesel Engine
(Export only)
-Typical View

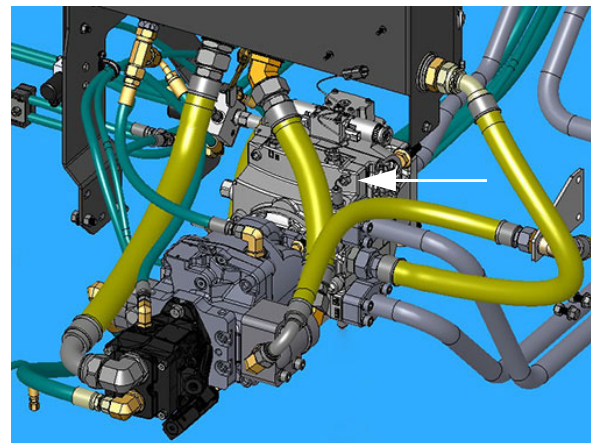

Hydrostatic Pump (Drive Pump)
-Typical View
(Viewed from top of machine)

Wheel Motors and Hubs

The drive system consists of hydraulic Wheel Motors and Gear Reduction Hubs (Wheel Hubs) located on each wheel.

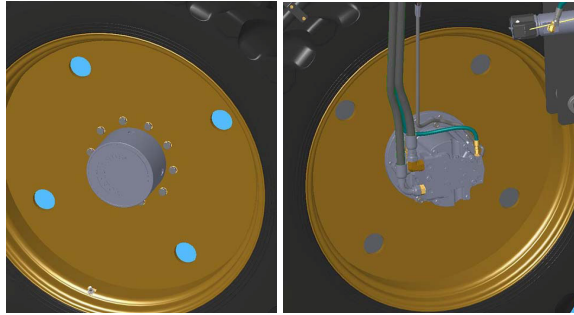

Wheel Motor/Hub Assembly
-Typical View

Parking Brake

The Parking Brake will engage when applied hydraulic pressure falls below 150 PSI (10.3 bar) or if the engine is shut off.

CAUTION

Do not engage the parking brake while the machine is moving. Failure to comply may result in personal injury and machine damage.

NOTICE

The parking brake is not intended for normal or emergency stopping.

NOTE: Bring the machine to a complete stop before engaging the Parking Brake.

The Parking Brake also controls the Ladder. When the Parking Brake is engaged, the Ladder will extend (lower). When the Parking Brake is disengaged, the Ladder will retract (raise).

To Engage the Parking Brake

CAUTION

Ensure the Hydrostatic Drive Control Handle is in the NEUTRAL position before engaging the parking brake. Failure to comply may result in personal injury and/or machine damage.

- **To engage the Parking Brake and lower the Ladder**, move the Hydrostatic Drive Control Handle to the NEUTRAL position.

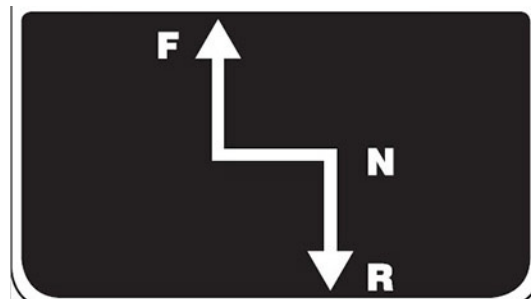

Hydrostatic Drive Control Handle
-Typical View

- Slide the red safety lever (located on the Parking Brake Switch) DOWN (Back) and press top of switch DOWN.



Parking Brake Switch
(Located near the Hydrostatic
Drive Control Handle)
-Typical View

NOTE: When the Parking Brake is engaged, a parking brake indicator (located on the top left-hand side of each Machine Display page) and the Parking Brake Switch will illuminate.

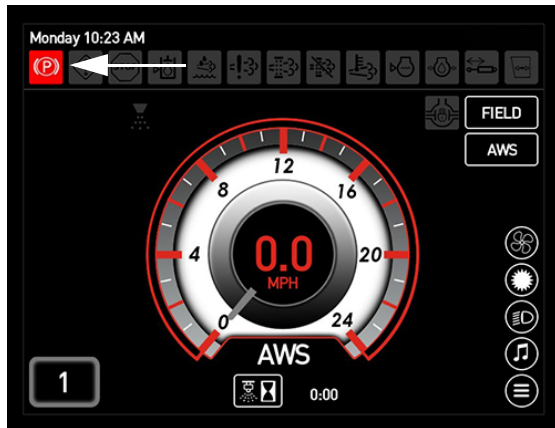

Parking Brake Indicator
(Located on the top left-hand
side of each Machine Display page)

To Disengage the Parking Brake

NOTE: If the Hydrostatic Drive Control Handle is out of neutral while the parking brake is engaged, a warning message will appear on the Machine Display stating, "Parking Brake on with control handle out of neutral."

Return control handle to neutral and toggle Parking Brake Switch to release." Press OK to acknowledge.

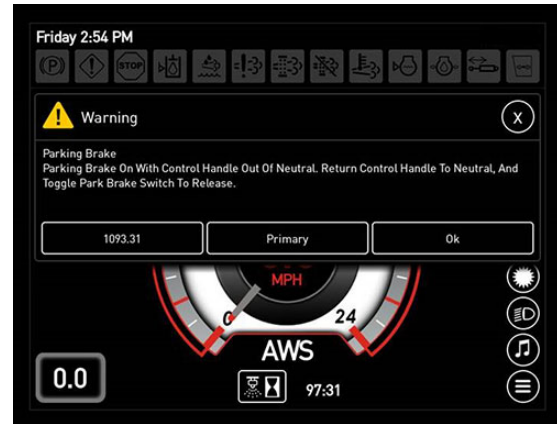

Parking Brake Warning

- To disengage the Parking Brake and raise the Ladder**, press the Parking Brake Switch in the DOWN (Off) position.

Deceleration (Decel) Pedal



When nearing an end row and speed deceleration is desired, press the Decel Pedal (located to the lower right-hand side of the steering column) to decrease speed.

NOTE: When the Decel Pedal is fully pressed, vehicle speed decreases to 0.



Decel Pedal
(Located to the lower right-hand
side of the steering column)
-Typical View

Speed Range

Your machine is featured with three speed ranges - Speed Range 1, Speed Range 2, and Speed Range 3. The speed range selected is displayed on the Machine Display Home Page - Road and Field Mode.

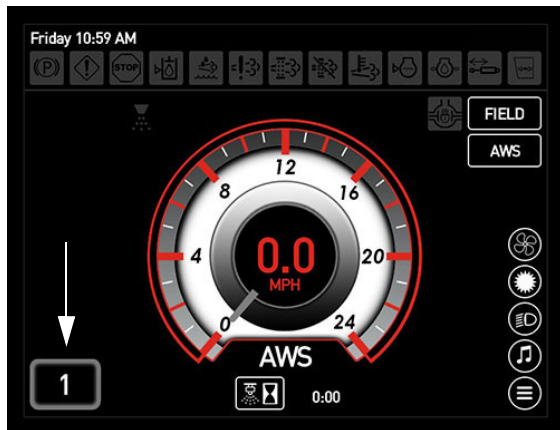

Speed Range
(Located on the Home Page
- Road and Field Mode)

Speed Range 1

In Speed Range 1, all wheel motors are at maximum displacement. Machine speed ranges from 0-13 mph (0-20 km/h)*.

Speed Range 2

In Speed Range 2, the front wheel motors are shifted to minimum displacement. Machine speed ranges from 0-19 mph (0-30 km/h)* with slightly less torque.

Speed Range 3

In Speed Range 3, the front and rear wheel motors are shifted to minimum displacement. Machine speed ranges from 0-28 mph (0-45 km/h)*.

NOTE: Speed Range 3 is available in Road Mode only. This range is always set to maximum speed and is non-operator adjustable.

** Speed ranges may vary, depending on tire size.*

To Change Speed Range

To adjust how fast the machine will travel in Speed Ranges 1 or 2, refer to “Machine Display” provided in the *Cab Section* elsewhere in this manual for further information.

Shift Up/Down Switches

Speed ranges are selected by pressing the Shift Up/Down Switches (located on the side of the Hydrostatic Drive Control Handle).

- Press the Shift Up Switch to INCREASE speed range.
- Press the Shift Down Switch to DECREASE speed range.

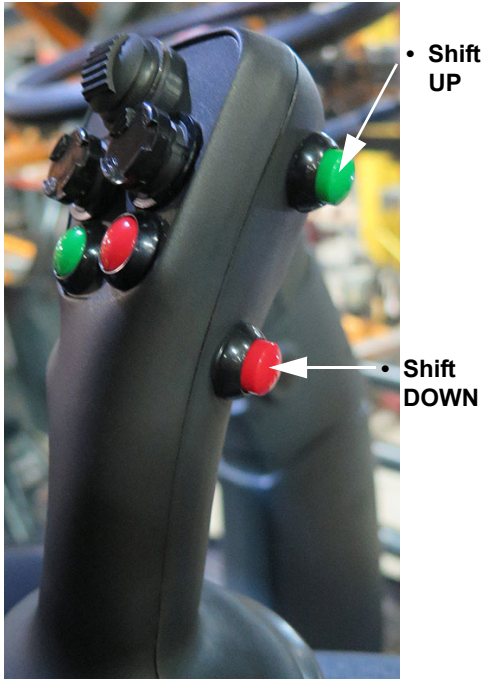

Shift Up/Down Switches
(Located on the side of the
Hydrostatic Drive Control Handle)
-Typical View



Throttle Switch
(Located near the Hydrostatic
Drive Control Handle)
-Typical View

NOTE: Engine speed can range between 850 and 2300 RPM in both Road and Field Mode.

The Throttle Switch works with a timer to tell the engine how fast to run. The longer the operator holds the switch in either direction (press UP/“rabbit icon” to increase the speed, press DOWN/“turtle icon” to decrease the speed), the more the engine will speed up or slow down.

Throttle Switch

The Throttle Switch (located near the Hydrostatic Drive Control Handle) is used to control engine speed (RPM).

NOTE: The operator may select throttle setting by operating the Throttle Switch. However, engine speed is also controlled by movement of the Hydrostatic Drive Control Handle.

To Change Throttle Setting Values

Refer to “Machine Display” provided in the *Cab Section* elsewhere in this manual for information.

Drive System Control

⚠ WARNING

Ensure the back-up alarm is audible when operating the machine in reverse.

NOTE: The NEUTRAL position must be met before changing the direction of the machine.

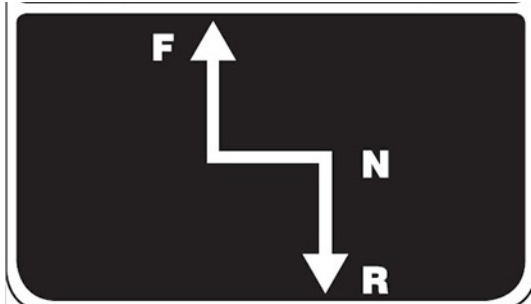

- **To move the machine forward**, slowly push the Hydrostatic Drive Control Handle FORWARD.

NOTE: The further the handle is moved forward, the faster the machine will travel and the engine speed will increase.

- **To move the machine in reverse**, slowly pull the Hydrostatic Drive Control Handle backward.

NOTE: Machine speed is limited to 9 mph (14.5 km/h) when in reverse.

NOTE: The farther back the handle is pulled, the faster the machine's speed.

- **To stop the machine**, slowly place the Hydrostatic Drive Control Handle in the NEUTRAL position.

NOTE: Before turning the engine off, reduce the engine speed and allow to idle for a minimum of three (3) minutes.

NOTICE

The operator can choose a minimum level above 850 RPMs of engine speed that they want to operate the machine with by using the Throttle Switch.

ALL-WHEEL STEER (AWS)

-If Equipped

^ Operator's with machines equipped with AWS pay special attention!

NOTICE

Become familiar with the machine in both coordinated and conventional steering modes before attempting to use the machine for its intended use. ^

NOTE: Read the following AWS information thoroughly and understand the operating instructions and safety precautions before operating.



Hagie Manufacturing Company recommends becoming familiar with and understanding how to operate your machine in conventional steering mode before operating AWS. Understand AWS system components, operating procedures, and system limitations before operating.

The term "coordinated steering" is used to describe the AWS feature. Coordinated steering is when the front wheels turn one direction and the rear wheels turn in the opposite direction to create a tighter turn angle, which allow the rear wheels to follow the front wheel tracks. Operating your machine in AWS mode makes turning more efficient by minimizing crop damage and ground disturbance.

Ensure you are comfortable driving the machine on the road and in the field, with the outriggers in the transport and detasseling positions, as well as performing a variety of different turning scenarios before attempting to operate AWS.

Progressive AWS

Hagie Manufacturing Company's Progressive AWS takes the original design and increases the active speed range while maintaining a safe turning radius. This is done by limiting how far the rear wheels will turn at higher speeds. The improvement allows operators to follow contours in the field and leave only one set of wheel tracks. This also allows them to make wide turns on end rows with only one set of wheel tracks.

Your rear wheels will track the front wheels, with limitations on speed and turning percentage. This is completely variable, so if you accelerate in a turn, your match on the rear will slowly come out. This feature keeps the machine safe when turning.

NOTE: If you want to match all the time, decrease your speed or make a less drastic turn.

NOTE: AWS is disabled when Auto Steer is activated.

Terminology

Conventional Steering

- Only the front wheels turn.

Coordinated Steering ^

- All the wheels turn and do so where the rear tires follow in the front tires' tracks.

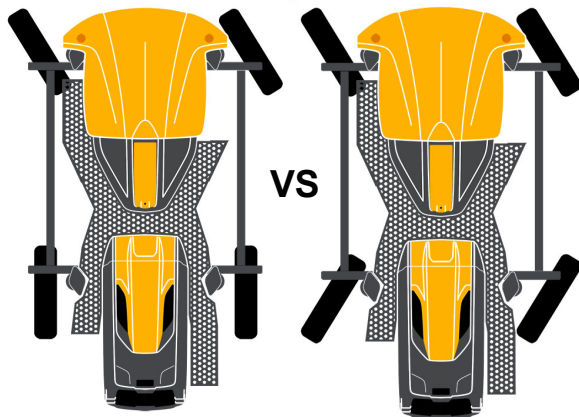

AWS Components

The Steering Cylinder (internal position) and External Proximity Sensors are used to track cylinder rod extension.

Steering Cylinders

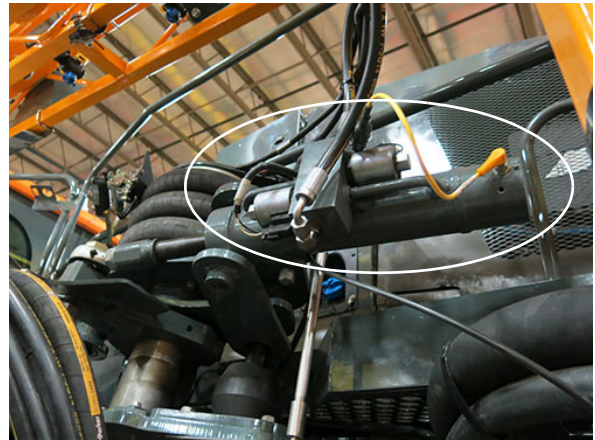

Steering Cylinder
(Located on the rear legs)
-Typical View

External Proximity Sensors

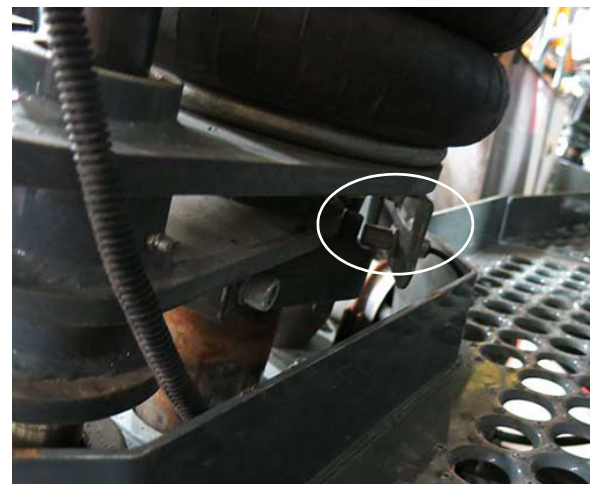

External Proximity Sensor
-Typical View

Lock Valves

Each rear cylinder is equipped with two (2) Lock Valves, which lock the cylinders into position when in Road mode and when the machine is not moving in Field mode.

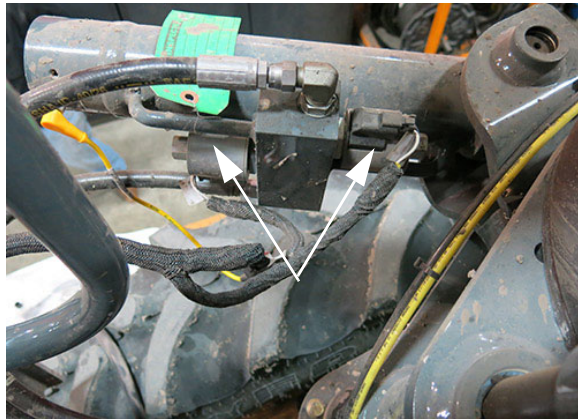

Lock Valves
-Typical View

Valve Manifold

Rear hydraulic steering is controlled by a Valve Manifold (located on the underside of the machine).

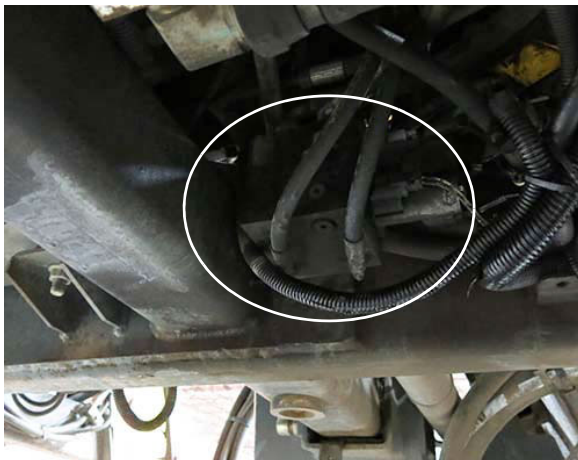

Valve Manifold
(Located on the underside of machine)
-Typical View

Operating AWS

All conditions must be met before AWS will activate. First, the machine must be in Field mode, and second, machine speed must be less than AWS Shutoff Speed. If these conditions are not met, the AWS Button will remain ON, but the AWS indicator will turn OFF, and the machine will be operating in conventional steering mode.

When conditions are met again, AWS will automatically activate and the AWS indicator will illuminate.

NOTE: The machine will automatically determine if the proper conditions have been met and change the status of the drive functions.

1. Ensure the machine's drive state is in Field mode.
2. Press the AWS Button (located on the Machine Display Home Page - Field Mode) to the ON (illuminated) position.

• AWS Button

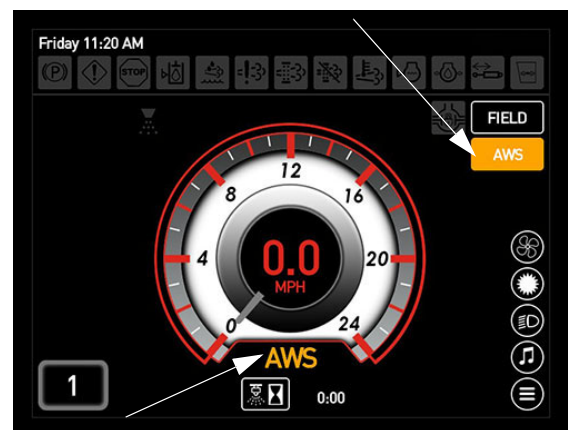

• AWS Indicator

An AWS indicator (located below the speedometer) will illuminate when AWS is activated (requiring all conditions to be met).

AWS Shutoff Speed

Refer to “Machine Display” provided in the Cab Section elsewhere in this manual for further information.

Limitations

- Machine speed is greater than AWS Shut-off Speed.

NOTE: There is no warning message associated with this. The machine will automatically switch to conventional steering mode.

- The machine's drive state must be in Field mode. If the machine is in Road mode, AWS is disabled (and the rear cylinder Lock Valves are locked).

- System Fault - The system is not working properly (e.g. sensor malfunction, hydraulic malfunction, etc.)

NOTE: A warning message will appear on the Machine Display and the machine may be limited on speed and other functions.

- **Auto Steer Machines Only:**
When the Auto Steer System is engaged, it will automatically turn the AWS System OFF and move the rear wheels back to straight.

Recommendations for Best Operating Practices

- Apply the Decel Pedal (located to the lower right-hand side of the steering column) to decrease speed at end rows.

NOTE: The Decel Pedal is NOT a brake! It is designated for speed reduction only.

- Speed ranges are selected by pressing the Shift Up/Down Switches (located on the side of the Hydrostatic Drive Control Handle).
- Use the Hydrostatic Drive Control Handle to slow down more if needed. If you move the Hydrostatic Drive Control Handle first and then shift down to get to AWS mode, you will notice that the machine may slow down more than you wanted it to.
- Understand how the machine feels when it is still in a turn and is shifted up or down. The machine will still operate at whatever turn angle that you want to shift out at, but you may feel that this situation is causing an operation that you may not want (possibly getting the machine off the line intended because the rear wheels move back to straight position and the total turning radius will change).

In the following illustration, the two circles represent a full turn with AWS on. The - - - - lines represent the direction the operator wants the front tracks to go (assuming the operator wants to pull the machine back into rows that are running straight up and down.)

The - - - - - lines represent the direction that the front wheels are pointed when the operator shifts out of AWS speed range. If this occurs, the rear wheels will shift back to the straight position and the machine will no longer have the two tire tracks (two circles). The rear wheels will begin to follow the - - - - - path during this shift.

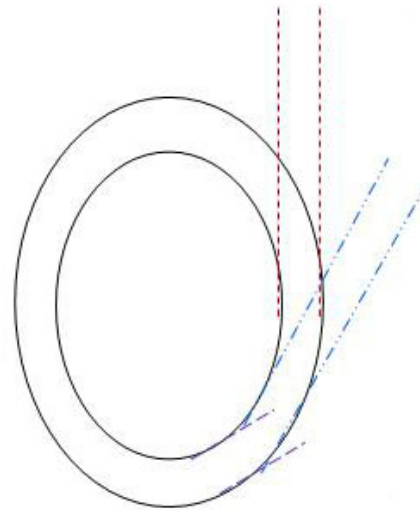

Hagie Manufacturing Company once again strongly recommends trying out and getting a feel for the AWS System before going straight to the field so you can get an understanding of what to expect. Some situations to try include:

- Driving the machine with both empty and a full solution tanks with AWS on.
- Drive the machine on hills, ensuring to take the proper precautions as stated in the *Safety and Precautions Section* elsewhere in this manual.
- Drive the machine at different turn angles and speeds to see how the limitations work.

NOTE: You will notice that if you go over any of the limitations, you can slow back down and the AWS system will automatically turn itself back on.

- **Auto Steer Machines Only:**
Notice how the machine feels when in AWS mode and switching from Auto Steer ON to OFF, especially when turning.
- Contact your local John Deere dealer with any questions you may have

SECTION 4 – ENGINE AND DRIVE SYSTEMS



regarding the operation of the AWS System.



SECTION 5 – HYDRAULIC SYSTEMS

HYDRAULIC SYSTEM COMPONENTS

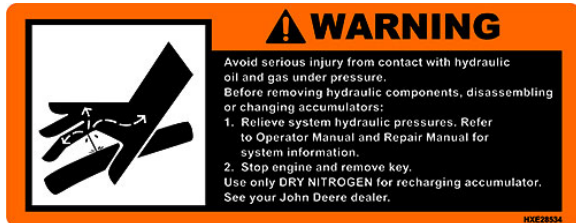

Hydraulic Pumps (Mounted to the engine)

- Pressure Compensated (PC) Pump
- Load Sense (LS) Pump
- Drive Pump

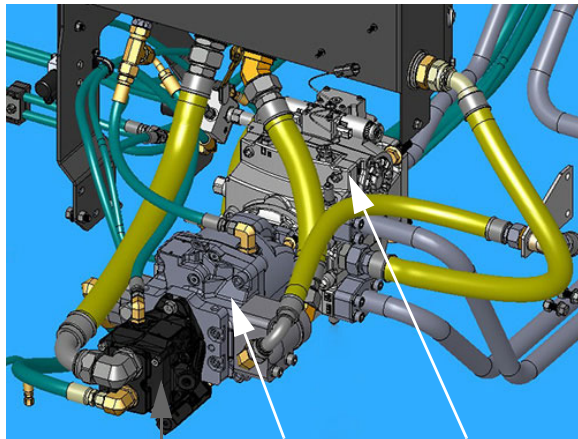

- PC Pump
- LS Pump
- Drive Pump

Hydraulic Pumps
-Typical View

The three Hydraulic Pumps (mounted to the engine) circulate hydraulic oil throughout the necessary systems and back through the oil cooler before returning it to the reservoir.

NOTICE

Operating the machine without adequate hydraulic oil level will result in system damage and will void the warranty.

If hydraulic oil level is too low for safe operation, a warning message will appear on the Machine Display to alert you of low hydraulic oil level. Press OK to acknowledge, shut down the engine immediately, and refill reservoir to proper level to avoid damage to the hydraulic systems.

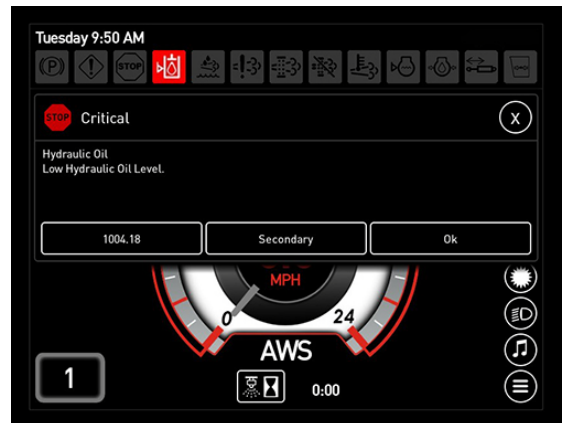

Low Hydraulic Oil Level Warning Message
(Located on the Machine Display)

PC Pump

The PC Pump powers the high-pressure filter, power steering, detasseler tool bar lift/fold functions, tread adjustment valve (if equipped), AWS valve (if equipped), and the variable pitch fan (if equipped).

LS Pump

The LS Pump powers the detasseler tool bar quad puller and cutter head motors.

Drive Pump

The Drive Pump powers the wheel motors.

SECTION 5 – HYDRAULIC SYSTEMS



Hydraulic Filtering/Cooling Components

- Auxiliary Hydraulic Oil Cooler
- Hydraulic Oil Reservoir
- Return Filters (2)
- Pressure Filter
- Tank Breather Cap
- Level/Temp Sensor

NOTE: Refer to the Maintenance and Storage Section elsewhere in this manual for information on filling the hydraulic oil reservoir and replacing hydraulic filters.



Hydraulic Oil Reservoir
(Located near rear left-hand side
of machine - open hood to access)
-Typical View

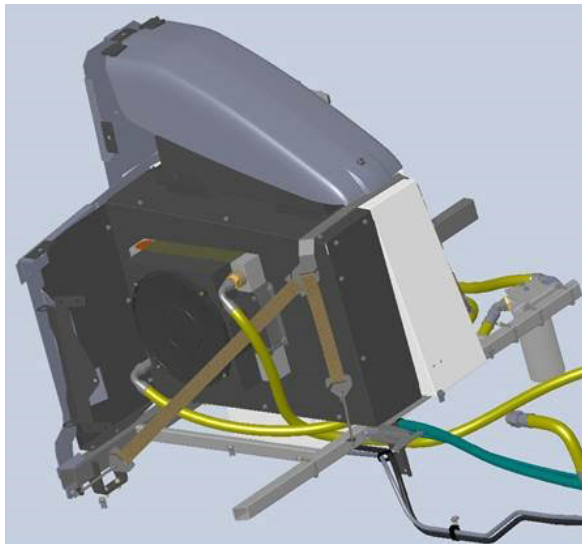

Auxiliary Hydraulic Oil Cooler
(Located inside the FRM
behind left-hand side of cab)
-Typical View



Return Filter 1
(Located inside filter housing on top of
hydraulic oil reservoir - open hood to access)
-Typical View



Return Filter 2
(Located beneath platform on
right-hand side of machine)
-Typical View



Tank Breather Cap
(Located on top of hydraulic oil
reservoir - open hood to access)
-Typical View

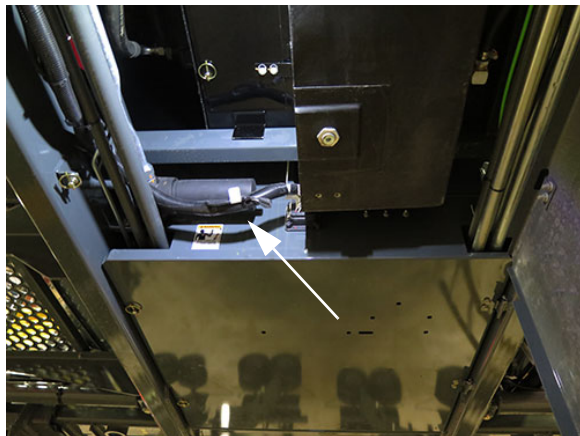

Pressure Filter
(Located beneath center of machine)
-Typical View

** Lower Tall Crop Package Belly Shield
to access - if equipped*

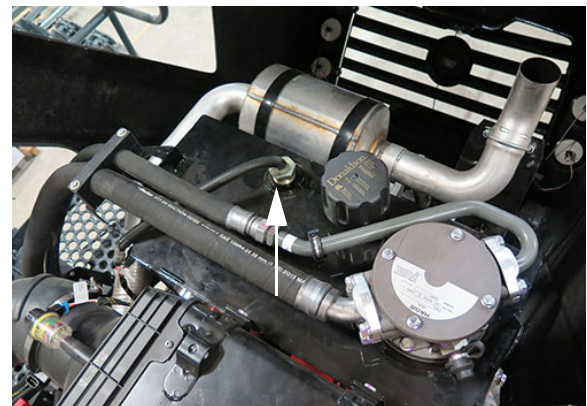

Level/Temp Sensor
(Located on top of hydraulic
oil reservoir - open hood to access)
-Typical View

Hydraulic Detasseling System Components

- (A) - Quad Puller
- (B) - Cutter Head
- (C) - Lift Cylinders
- (D) - Electro-Hydraulic Lift Control Valve
- (E) - Outrigger Fold Valve
- (F) - Motor Control Valve

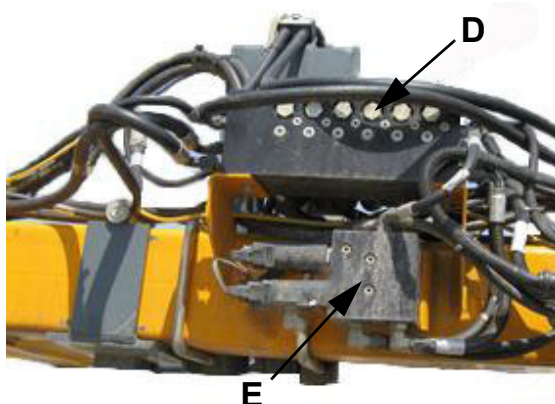

Refer to the *Detasseling Systems Section* elsewhere in this manual for further information.

REVERSIBLE FAN - VARIABLE PITCH

NOTE: If your machine is equipped with the Viscous Clutch Fan, refer to the Miscellaneous Section elsewhere in this manual for further information.

⚠ WARNING

Improper operation, maintenance, or repair of this product can be dangerous and may result in serious injury or death.

- Always use Hagie-approved parts and components. Failure to comply will result in voiding the 1-year parts warranty.
- Do not operate or perform any service on this product until you have read and understand the operation and maintenance information. Contact your local John Deere dealer for any additional information that you may require.
- The person(s) servicing the product may be unfamiliar with many of the systems or components of the product. Use caution when performing service. Knowledge of the product and components are important before the removal or disassembly of any component.

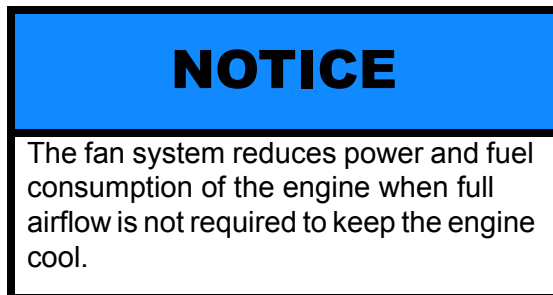

The Reversible Fan is a hydraulically-controlled variable pitch fan capable of rotating the fan blades to reduce or reverse air flow. It is mounted to the engine and uses hydraulic pressure to rotate the fan blades to change the pitch and increase/decrease airflow through the cooling pack as needed. The fan is controlled by an Electronic Control Unit (ECU) based off of temperature sensors from the cooling system.

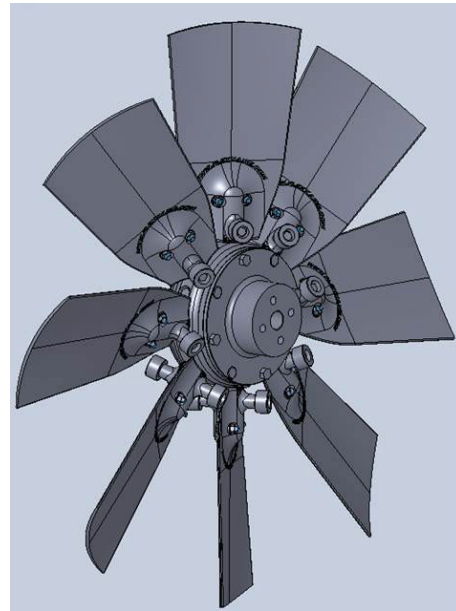

Variable Pitch Fan
(Located near the rear of machine
- open hood to access)
-Typical View

To Activate the Reversible Fan

Refer to “Machine Display” provided in the *Cab Section* elsewhere in this manual for complete operating instructions.

Before Starting the Engine

1. Ensure all hoses and wires are adequately secured and routed away from the fan operating area.
2. Ensure all tools have been removed from the engine compartment, including the top side of the radiator and inside of the shroud before the fan guards are installed. Obstacles in the path of rotation can interfere with movement of the fan and can result in damage to the fan blades, fan hub, and radiator core.
3. Inspect the radiator shroud mounting bolts to ensure that the radiator and shroud are firmly secured and unable to move during operation of the machine. Loose shroud bolts can allow the fan shroud to move into the path of the rotating blades and loose radiator mounting bolts can allow the radiator to flex in

position, allowing the shroud to come into contact with the rotating fan blades.

4. Ensure all fan guards have been installed and firmly secured into place. The Reversible Fan creates an abundant amount of airflow in both cooling and cleaning mode operation. The result of this airflow is a strong vacuum effect that can suck in items that are located inside or around the engine compartment fan.
5. To ensure maximum efficiency, start with a clean cooling system free of debris, paying particular attention to the stacked cooler core(s).

Service and Maintenance

⚠ WARNING

Ensure the Battery Disconnect Switch is OFF before performing any service on the fan. Failure to comply may result in engine turnover, serious injury, or death.

Under normal operating conditions, the Reversible Fan does not require scheduled maintenance (other than lubrication) and is built to provide thousands of hours of trouble-free service.

In moderate to extreme operating conditions, a visual inspection of moving parts is recommended from time to time to safeguard against fan blade damage, which could lead to equipment and/or other damage.

TREAD ADJUSTMENT - HYDRAULIC

-If Equipped

NOTE: Refer to the Miscellaneous Section elsewhere in this manual for information on adjusting Manual Tread Width (if equipped).

Your machine may be equipped with Hydraulic Tread Adjust to boost capability and perform applications for various field row widths and cropping stages with minimal crop damage.

Tread Range

- Minimum Tread Width = 120" (304.8 cm)*
- Maximum Tread Width = 160" (406.4 cm)*

* Depending on tire size.

To Adjust Tread Width

⚠ CAUTION

Never adjust hydraulic tread width on a public roadway. Ensure the machine is on level ground where there are no ditches or valleys to interfere while you perform the adjustment.

NOTICE

Never adjust tires wider than 160"/406.4 cm (center-to-center). Failure to comply may result in leg damage.

NOTICE

Survey your surroundings and allow yourself enough room to adjust tread width in either forward or reverse.

NOTICE

The machine must be in motion while adjusting tread width. Failure to comply may result in machine damage.

NOTICE

The machine's drive state must be in FIELD MODE before adjusting tread width.

1. Ensure the Tread Adjust Slide Path (located on each leg) has an adequately lubricated surface to slide along during adjustment.

NOTE: Refer to "Service - Lubrication" provided in the Maintenance and Storage Section elsewhere in this manual for further information.

2. Survey your surroundings and allow yourself enough room to adjust the tread in either forward or reverse.
3. Press the Tread Button (located on the Machine Display Main Menu) to navigate to the "Tread Width Adjustments" screen.

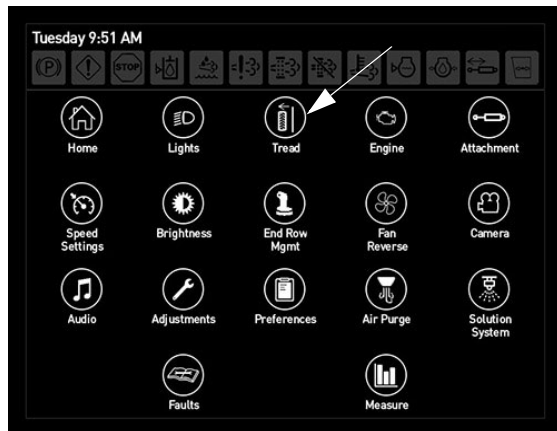

Tread Button
(Located on the Machine Display Main Menu)

4. While driving one or two miles per hour (1.6 to 3.2 km/h), press and hold the desired Left or Right Tread Adjustment Button (located on the Machine Display "Tread Width Adjustments" screen) to move tread in or out as desired.

NOTE: Both front and rear tread will extend/retract when the corresponding Left and Right Tread Adjustment Buttons are pressed. However, if precise balance is desired, individual tread adjustment is recommended.

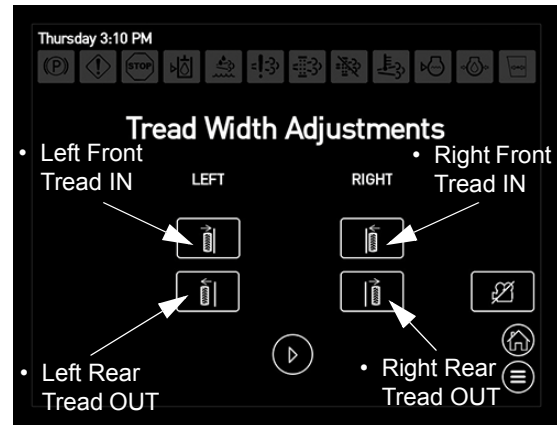

Left/Right Tread Adjustment Buttons
(Located on the Machine Display Tread Width Adjustments Screen)

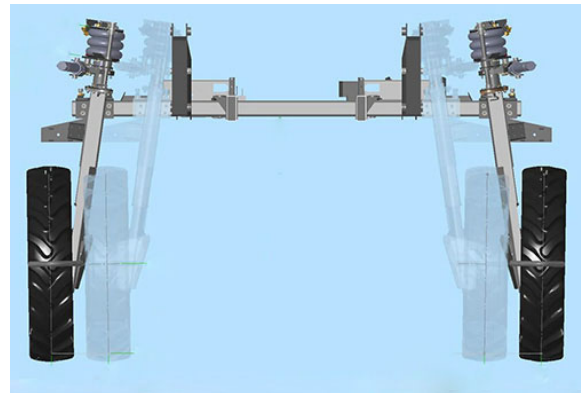

5. Observe the corresponding Tread Adjust Indicator (located on the legs).



Tread Adjust Indicator
-Typical View

6. Release the Tread Adjustment Button when desired tread width is achieved.

To Adjust Individual Tread Width

1. Press the Next Button (located on the Machine Display “Tread Width Adjustments” screen) to navigate to the “Individual Tread” screen.

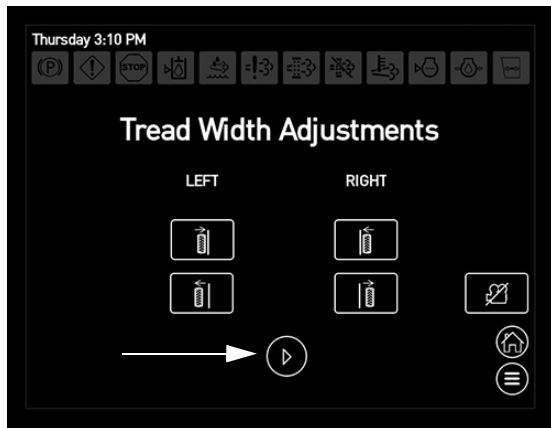

Next Button
(Located on the Machine Display
Tread Width Adjustments Screen)

2. On the “Individual Tread” screen, select the tread that you wish to individually adjust by pressing the desired “wheel(s)” on the display screen.

NOTE: You may also select all four (4) “wheels” to adjust all four tread widths simultaneously.

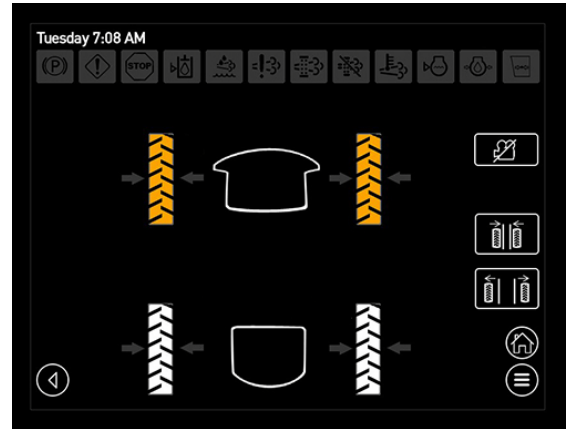

Individual Tread Screen

3. Survey your surroundings and allow yourself enough room to adjust the tread in either forward or reverse.
4. While driving one or two miles per hour (1.6 to 3.2 km/h), press and hold the Tread In or Out Button until desired tread width is obtained.

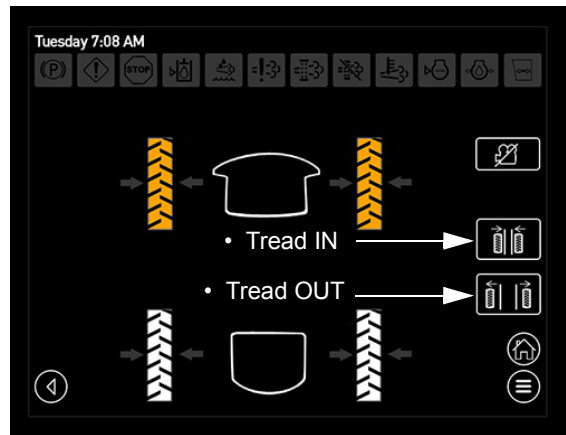

Tread In/Out Buttons
(Located on the Individual Tread Screen)

5. Observe the corresponding Tread Adjust Indicator (located on the legs).



Tread Adjust Indicator
-Typical View

6. Release the Tread In or Out Button when desired tread width is achieved.

NOTE: The Tread In/Out Button(s) may only be held for 9 seconds. Exceeding 9 seconds will require the button(s) to be repressed.

Rear-view Camera Activation While Adjusting Tread Width

A Rear-view Camera Activation Button is located on both the “Tread Width Adjustments” screen and the “Individual Tread” screen to allow the operator to turn the rear-view camera on/off directly from the tread screens.

- Press the Rear-view Camera Activation Button in the illuminated position to turn rear-view camera OFF. Press button again to turn rear-view camera ON.

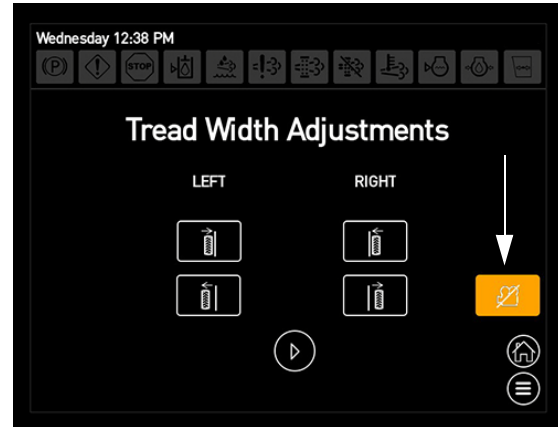

Rear-view Camera Activation Button
(Located on the Tread Width Adjustments Screen and Individual Tread Screen)
- Deactivated (illuminated) position shown

LADDER

IMPORTANT

If the operator is out of the seat with the Hydrostatic Drive Control Handle in neutral for five (5) seconds, the Parking Brake will engage, the ladder will lower, and the parking brake indicator on the Machine Display will illuminate.

To Disengage the Parking Brake:

1. The operator must be seated in the operator's seat.
2. Ensure the Hydrostatic Drive Control Handle is in the NEUTRAL position.
3. Toggle the Parking Brake Switch on, then off again.

⚠ CAUTION

Upright ladder is not a service platform or step.

- DO NOT step on the ladder while in the upright position.
- DO NOT lower the ladder while anyone is on the ground near the machine.
- DO NOT attempt to lower the ladder from ground level.

Failure to comply may result in injury.

To Lower the Ladder

⚠ CAUTION

Ensure the Hydrostatic Drive Control Handle is in the NEUTRAL position before engaging the parking brake. Failure to comply may result in personal injury and/or machine damage.

- **To lower the Ladder**, move the Hydrostatic Drive Control Handle to the NEUTRAL position.

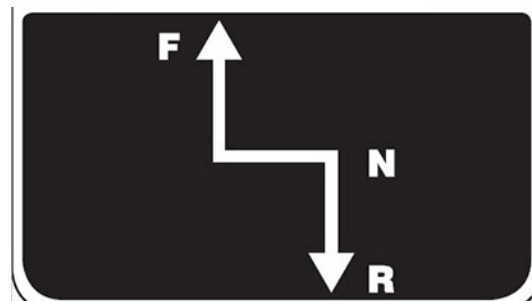

Hydrostatic Drive Control Handle
-Typical View

- Slide the red safety lever (located on the Parking Brake Switch) DOWN (Back) and press top of switch DOWN.

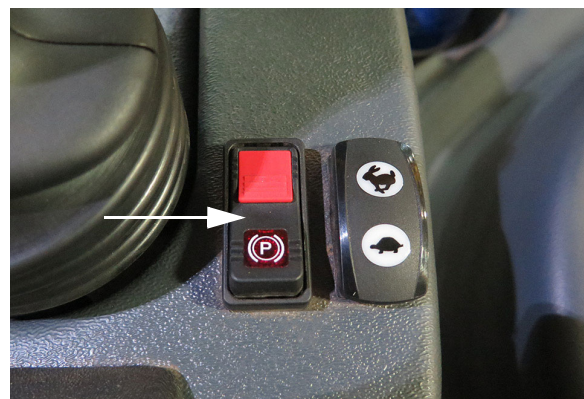

Parking Brake Switch
(Located near the Hydrostatic Drive Control Handle)
-Typical View



Ladder
-Typical View
* Lowered position shown

NOTE: When the Parking Brake is engaged, a parking brake indicator (located on the top left-hand side of each Machine Display page) and the Parking Brake Switch will illuminate.

To Raise the Ladder

- **To raise the Ladder**, press the Parking Brake Switch in the DOWN (Off) position.

NOTE: When the Ladder is raised, the Parking Brake will be OFF (disengaged).



SECTION 6 – ELECTRICAL SYSTEMS

BATTERIES

⚠ WARNING

Battery posts, terminals, and related accessories contain lead and lead compounds, chemicals known to the State of California to cause cancer and reproductive harm. Wash hands after handling.

⚠ CAUTION

Batteries contain sulfuric acid. Avoid contact with skin, eyes, or clothing. Do not inhale fumes or ingest liquid. Batteries contain gases which can explode. Keep sparks and flame away while servicing.

⚠ CAUTION

Disconnect the battery when servicing any part of the electrical system. Failure to comply may result in injury and property damage.

Access

The batteries are located on the rear right-hand side of machine.

NOTE: When servicing the electrical system, always remove the batteries (removing the ground cable first). When reinstalling the batteries, connect the ground cable last.

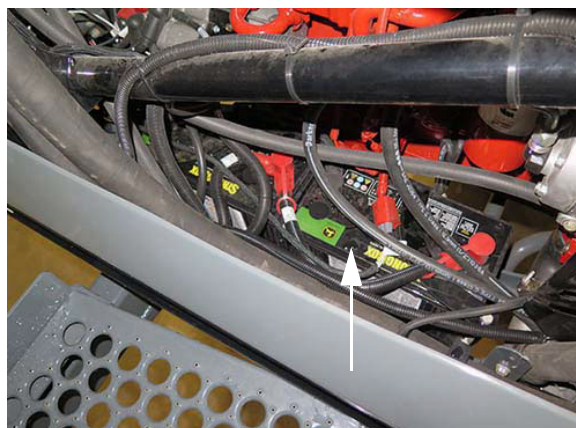

Batteries
(Located on the rear
right-hand side of machine)
-Typical View

Charging

⚠ CAUTION

Electrical system is 12-volt negative ground. When using booster with jumper cables, precautions must be taken to prevent personal injury or damage to electrical parts.

1. Attach one end of jumper cable to positive booster terminal and other end to positive terminal of vehicle battery connected to starter motor.
2. Attach one end of second cable to negative booster terminal and other end to vehicle frame away from battery.
3. To remove cables, reverse above sequence exactly to avoid sparks. See operator's manual for additional information.

For your convenience, a set of Auxiliary Battery Charging Posts are located on the rear mainframe for ease of charging the batteries.



Auxiliary Battery Charging Posts
(Located on the rear mainframe)
-Typical View

Connect your charging cables to the Auxiliary Battery Charging Posts just as you would to the battery - positive cable to the positive terminal, and negative cable to the negative terminal.

NOTE: Keep these terminals clean and their caps in place when not in use.

NOTICE

To ensure sufficient electrical contact, battery terminal connections should be as clean and tight as possible.

Cleaning

- Disconnect the battery cables from the batteries.
- Remove any corrosion with a wire brush or battery post brush.
- Wash the battery cable connections and posts with a mild baking soda and ammonia solution.
- Apply grease (or dielectric grease) to prevent corrosion.
- Reconnect the batteries, ensuring connections are tight.
- Clean every 100 hours of operation.

Replacement

Install replacement batteries with ratings equivalent to the following specifications:

- **Voltage** - 12V only
- **CCA** - 30 seconds at 0° F. (950)
- **Reserve Capacity** - 185 minutes at 25 amps

Storage

Refer to “Storage” provided in the *Maintenance and Storage Section* elsewhere in this manual for further information.

BATTERY DISCONNECT SWITCH

WARNING

DO NOT use the Battery Disconnect Switch as a safety device when performing work to the electrical system. Disconnect the negative battery cable before servicing.

IMPORTANT

- Do not bypass disconnect.
- Do not terminate electrical devices to battery terminals.
- Turn switch off before servicing electrical equipment.
- Completely isolate electronics before welding by disconnecting battery negative terminal.
- Rotate switch to “ON” position for operation.

Your machine is equipped with a Battery Disconnect Switch (located on the rear mainframe) to de-energize battery power, cutting all electrical power to the engine.

- Rotate the Battery Disconnect Switch to the ON (clockwise) or OFF (counter-clockwise) positions to operate.

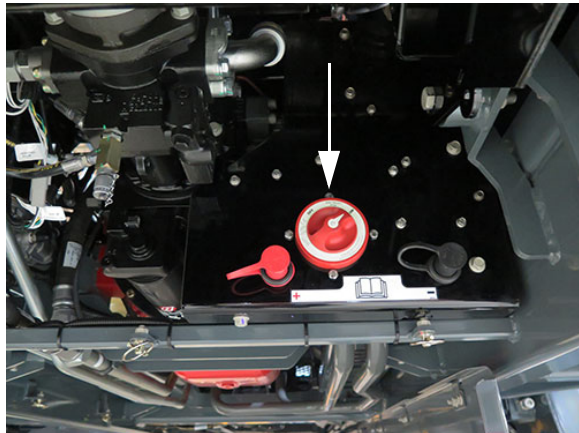

Battery Disconnect Switch
(Located on the rear mainframe)
-Typical View

NOTE: Turn the Battery Disconnect Switch OFF during long storage periods.

*NOTE: **Final Tier 4 Engines** - Allow the Diesel Exhaust Fluid (DEF) Recirculation Pump to finish running before turning the Battery Disconnect Switch off.*

FUSES AND RELAYS

Interior Cab Functions



Circuit Breakers/Fuses (Interior)
(Located rear of side console -
remove tray to access)
-Typical View

The following label is affixed beneath the side console (remove tray to access) and provides information on component fuse/relay amperage ratings.

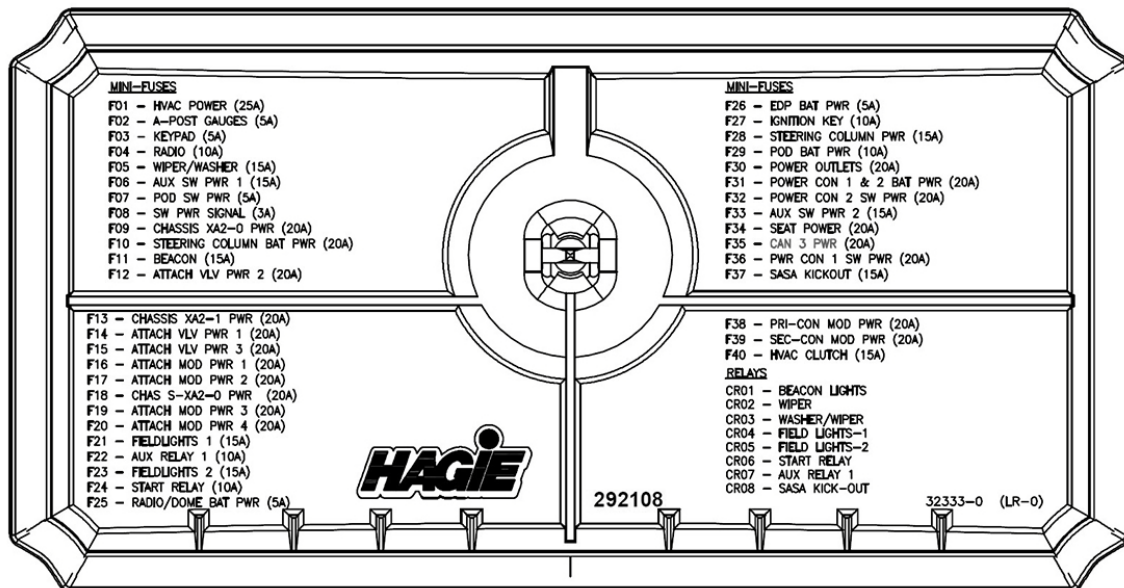

SECTION 6 – ELECTRICAL SYSTEMS



Exterior Lights/System Functions

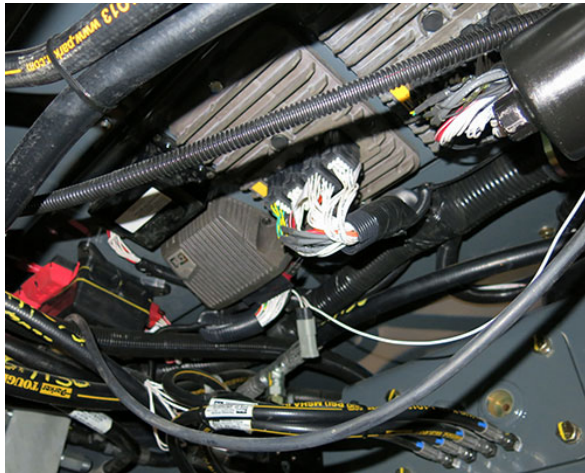

Circuit Breakers/Fuses (Exterior)
(Located beneath cab -
remove panel to access)
-Typical View

The following label is affixed beneath the cab and provides information on component fuse/
relay amperage ratings.

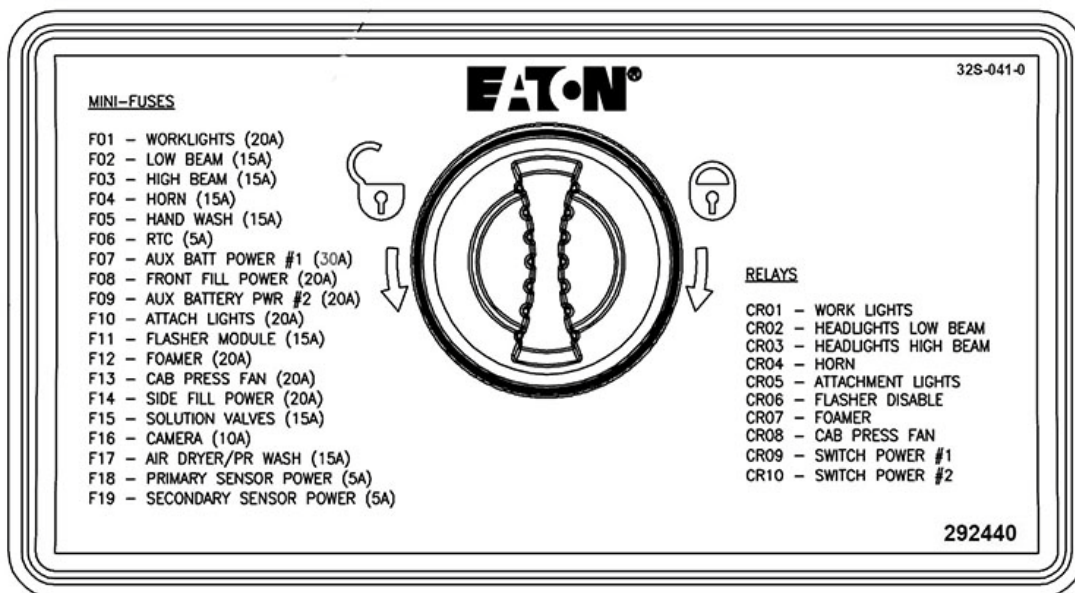

Final Tier 4 Engine



Final Tier 4 Engine Fuse/Relay Block
(Located beneath batteries on the rear right-hand side of machine)
-Typical View

The following labels are affixed near the engine fuse/relay block and provide information on component fuse/relay amperage ratings.

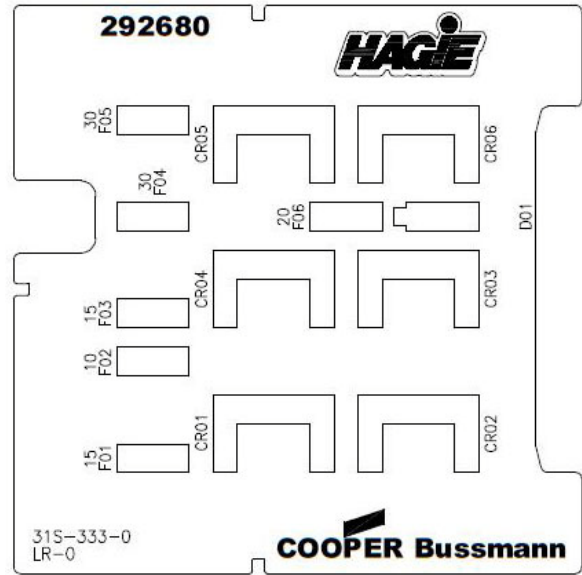
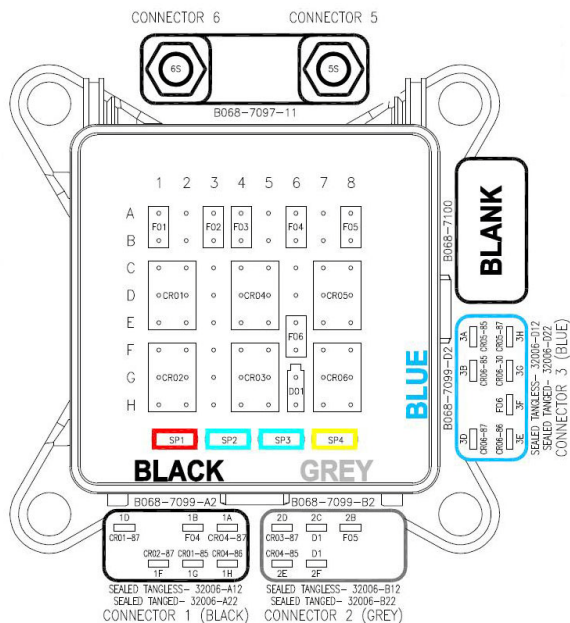

Device Placement

Pos.	Ref.	Device	Part No.
D1	F01	Mini Fuse	ATM-15UNP-PEC
D2	F02	Mini Fuse	ATM-10UNP-PEC
D3	F03	Mini Fuse	ATM-15UNP-PEC
D4	F04	Mini Fuse	ATM-30UNP-PEC
D5	F05	Mini Fuse	ATM-30UNP-PEC
D6	R1	12V, 35A 5-Pin Micro	B120-7025
D7	R4	12V, 35A 5-Pin Micro	B120-7025
D8	R5	12V, 35A 5-Pin Micro	B120-7025
D9	F06	Mini Fuse	ATM-20UNP-PEC
D10	R2	12V, 35A 5-Pin Micro	B120-7025
D11	R3	12V, 35A 5-Pin Micro	B120-7025
D12	R6	12V, 35A 5-Pin Micro	B120-7025
D13	D01	6A Diode	22903-6V

SECTION 6 – ELECTRICAL SYSTEMS



Spare Device Placement		
Position	Device	Part No.
SP1	Mini Fuse	ATM-10UNP-PEC
SP2	Mini Fuse	ATM-15UNP-PEC
SP3	Mini Fuse	ATM-20UNP-PEC
SP4	Mini Fuse	ATM-30UNP-PEC

Device Totals		
Device	Part No.	Amount
Mini Fuse	ATM-10UNP-PEC	2
Mini Fuse	ATM-15UNP-PEC	3
Mini Fuse	ATM-20UNP-PEC	2
Mini Fuse	ATM-30UNP-PEC	3
6A Diode	22903-6V	1
12V, 35A 5-Pin Micro	B120-7025	6

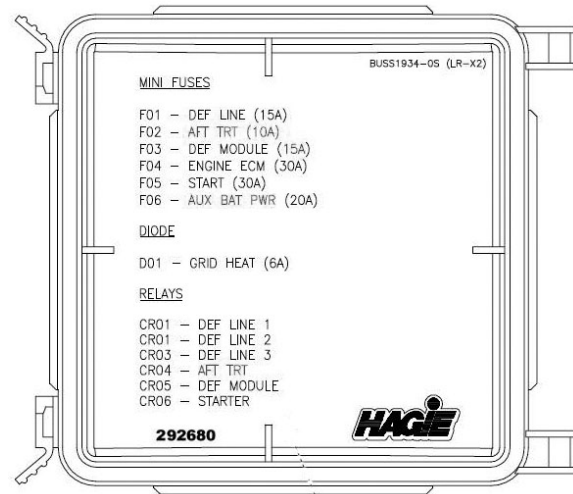

Hood Actuator Fuse



Hood Actuator Fuse
(Located beneath rear
right-hand side of machine)
-Typical View
Remove rear panel and brush curtain to
access if equipped with Tall Crop Package

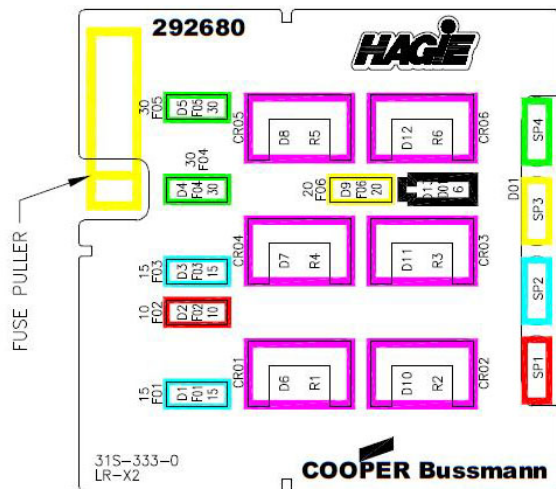

FUSE AND RELAY RATINGS

Fuses and Relays - Exterior (Located beneath cab) <i>* Remove panel to access</i>		
Fuse	Rating (Amps)	Function
F01	20	Work Lights
F02	15	Highway Lights (Low Beam)
F03	15	Highway Lights (High Beam)
F04	15	Horn
F05	15	Hand Wash (N/A)
F06	5	RTC Battery Power
F07	30	Auxiliary Battery Power 1
F08	20	Front Fill Power (N/A)
F09	20	Auxiliary Battery Power 2
F10	20	Attachment Lights (N/A)
F11	15	Flasher Module
F12	20	Foam Marker (N/A)
F13	20	Cab Pressure Fan
F14	20	Side Fill Power (N/A)
F15	15	Solution Valves (N/A)
F16	10	Camera
F17	15	Air Dryer/Pressure Washer (N/A)
F18	5	Primary Sensor Power
F19	5	Secondary Sensor Power
Relay	Rating (Amps)	Function
CR01	35	Work Lights
CR02	35	Headlights (Low Beam)
CR03	35	Headlights (High Beam)
CR04	35	Horn
CR05	35	Attachment Lights (N/A)
CR06	35	Flasher Disable
CR07	35	Foam Marker (N/A)

**SECTION 6 –
ELECTRICAL SYSTEMS**



CR08	35	Cab Pressure Fan
CR09	35	Switch Power 1
CR10	35	Switch Power 2
Fuses and Relays - Interior (Located rear of side console) <i>* Remove tray to access</i>		
Fuse	Rating (Amps)	Function
F01	25	HVAC Power
F02	5	A-Post Gauges
F03	5	Keypad (N/A)
F04	10	Radio Power
F05	15	Wiper/Washer Power
F06	15	Auxiliary Switched Power 1
F07	5	Pod Switched Power
F08	3	Switched Power Signal
F09	20	Chassis XA2-0 Power
F10	20	Steering Column/Battery Power
F11	15	Rotating Beacon
F12	20	Attachment Valve Power 2
F13	20	Chassis XA2-1 Power
F14	20	Attachment Valve Power 1
F15	20	Attachment Valve Power 3
F16	20	Attachment Module Power 1
F17	20	Attachment Module Power 2
F18	20	Chassis S-XA2-0 Power
F19	20	Attachment Module Power 3
F20	20	Attachment Module Power 4
F21	15	Field Lights 1
F22	10	Auxiliary Relay 1
F23	15	Field Lights 2
F24	10	Start Relay
F25	5	Radio/Dome Battery Power
F26	5	EDP Battery Power
F27	10	Ignition Key

F28	15	Steering Column Power
F29	10	Pod Battery Power
F30	20	Power Outlets
F31	20	Power Connector 1 and 2 Battery Power
F32	20	Power Connector 2/Switched Power
F33	15	Auxiliary Switch Power 2
F34	20	Seat Power
F35	20	CAN 3 Power
F36	20	Power Connector 1/Switched Power
F37	15	SASA Kick-out Signal
F38	20	Primary Controller Power (beneath cab)
F39	20	Secondary Controller Power (beneath cab)
F40	15	HVAC Clutch
Relay	Rating (Amps)	Function
CR01	35	Rotating Beacon Light
CR02	35	Wiper
CR03	35	Wiper/Washer
CR04	35	Field Lights 1
CR05	20	Field Lights 2
CR06	20	Start Relay
CR07	35	Auxiliary Relay 1
CR08	20	SASA Kick-out
Fuses and Relays - Final Tier 4 Engine (Located on engine skid beneath batteries)		
Fuse (Mini)	Rating (Amps)	Function
F01	15	DEF Line
F02	10	After Treatment
F03	15	DEF Module
F04	30	Engine ECM
F05	30	Start
F06	20	Auxiliary Battery Power
Diode	Rating (Amps)	Function

**SECTION 6 –
ELECTRICAL SYSTEMS**



D01	6	Grid Heater
Relay	Rating (Amps)	Function
CR01		DEF Line 1
CR01		DEF Line 2
CR03		DEF Line 3
CR04		After Treatment
CR05		DEF Module
CR06		Starter



SECTION 7 – DETASSELING SYSTEMS

DETASSELING SYSTEM COMPONENTS

The Detasseling System is a constantly monitored and continuously adjusted system. The cab-mounted control system receives data from the photo light sensors to determine detasseling height.

The following information in this section explains the detasseling components and their operation. Read the following section entirely before operating the Detasseling System.

NOTICE

Attachment maintenance and repair, including clearing blockages/unplugging detasseler components should be performed by qualified service personnel only.

- (A) - Detasseler Tool Bar
- (B) - LS System 12/Depth Command
- (C) - LS Photo Light Sensors
- (D) - Cutter Heads
- (E) - Quad Pullers
- (F) - Machine Display
- (G) - All Up/Down Switch*
- (H) - Outrigger Fold Switches (Left/Right)
- (I) - Main Motor Switch

* The Lift Icon Buttons on the Machine Display “DTB Lifts/Motors” screen may also be used to raise/lower all lifts simultaneously.

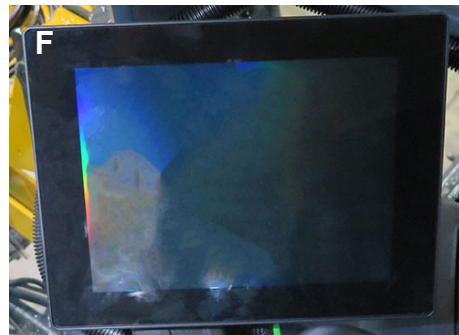
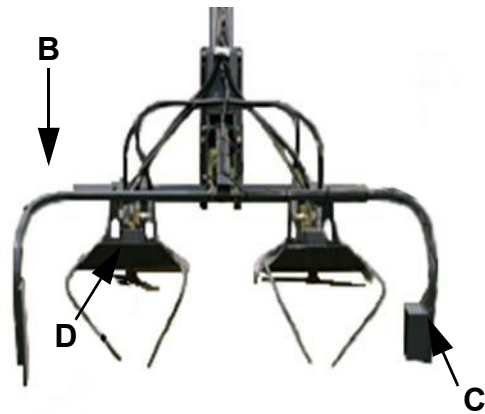

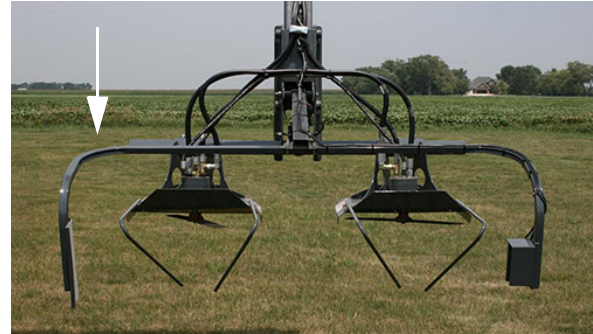
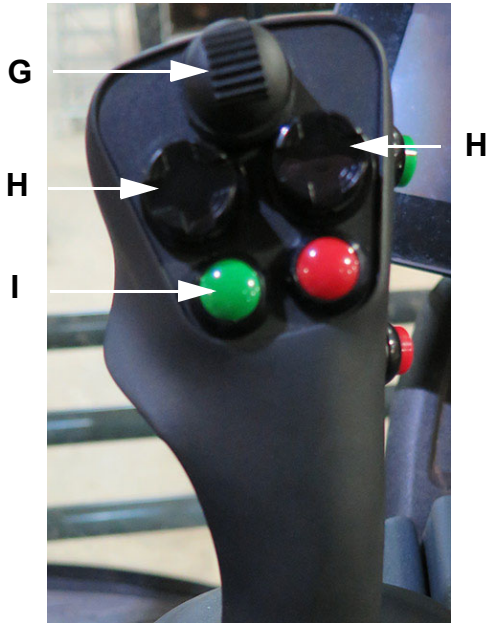

LS System 12/Depth Command
-Typical View

LS Photo Light Sensors

The LS Photo Light Sensors detect crop height and send a signal to the LS System 12/Depth Command, which controls automatic height adjustment.

Detasseler Tool Bar

The D400 provides a high-clearance design along with adjustable automatic height control to perform timely detasseling of corn crops when timing is critical. The tool bar unites functionality with customizable options to provide a solution that suits the individual needs of your operation.



Detasseler Tool Bar
(Shown with quad pullers)
-Typical View



LS Photo Light Sensor Assembly
-Typical View

LS System 12/Depth Command

The LS (Light Sensing) System 12/Depth Command is an automatic height adjustment system controlled by the Machine Display inside the cab.

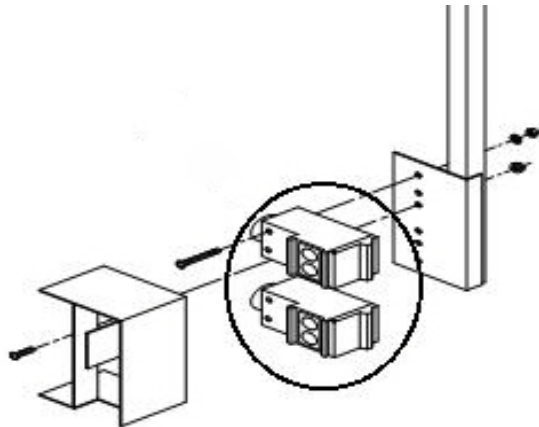

LS Photo Lights (Upper/Lower)
-Typical View

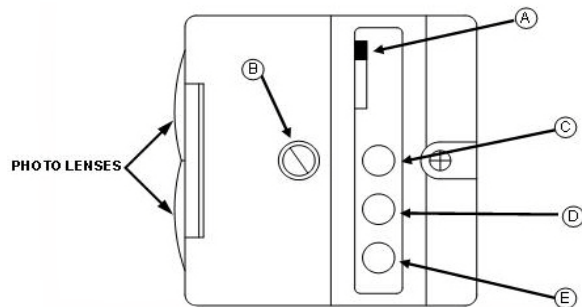

-Typical View

- The upper and lower LS Photo Lights are equipped with LED lights (A, C, D, E) that indicate operation status.
- The LT/DK (Light/Dark) Switch (A) (located on the photo light sensor) changes the activated condition of the green LED from ON (LT) to OFF (DK).
- The Sensitivity Adjustment Screw (B) should always be set to MAXIMUM.
- The Yellow LED Light (C) indicates the power is ON.
- The Green LED Light (D) indicates output energized (sending a signal to the Tasselrol™ XL/LS System 12).
- The Red LED Light (E) indicates that the photo light is receiving reflected signal.

Cutter Heads



CAUTION

SEVERING OF FINGERS OR HAND.
DO NOT PLACE FINGERS OR
HAND NEAR A MOVING CUTTER BLADE,
ATTEMPT TO STOP A MOVING CUTTER
BLADE, OR PERFORM MAINTENANCE
NEAR A MOVING CUTTER BLADE.

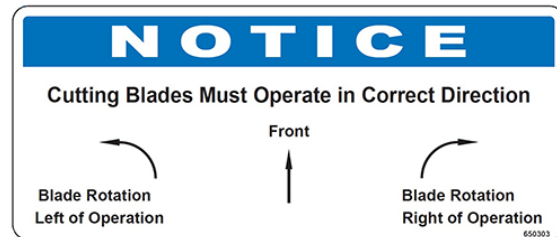

The hydraulically-driven Cutter Heads go through rows of corn and cut the tassels from the top of corn plants.

Cutter Head Speeds		
Min Speed	=	2900 RPM
Mid Speed	=	3000 RPM
Max Speed	=	3100 RPM

NOTE: It is recommended to set the cutter heads as close to "mid" speed range as possible.

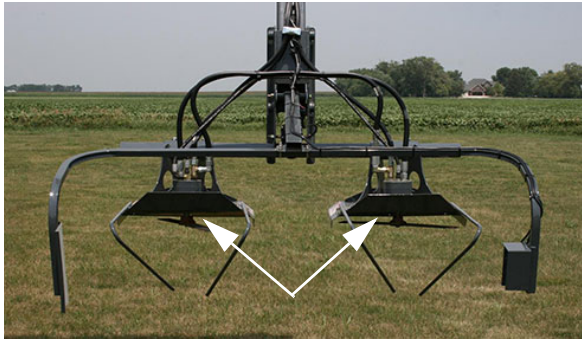

Cutter Heads
-Typical View

Quad Puller Speeds		
Min Speed	=	375 RPM
Mid Speed	=	400 RPM
Max Speed	=	425 RPM

NOTE: It is recommended to set the quad pullers as close to “mid” speed range as possible.

Quad Pullers

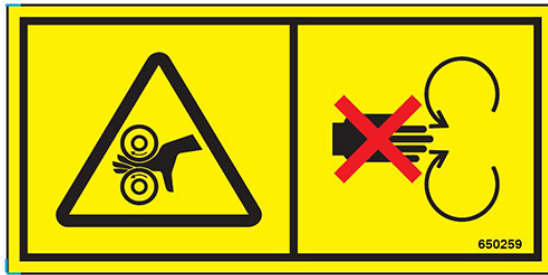

CAUTION

RISK OF INJURY FROM ROTATING TIRES. DO NOT PLACE FINGERS OR HAND NEAR MOVING QUAD PULLER TIRES, DISLodge A WEDGED OBJECT FROM MOVING TIRES, OR PERFORM MAINTENANCE NEAR MOVING TIRES.

NOTICE

Ensure quad puller tires have equal pressure. Check tire pressure daily.

NOTE: Maximum tire pressure = 10 psi (.7 bar).

The hydraulically-driven Quad Pullers go through rows of corn and pull the tassels from the top of corn plants by catching it between the Quad Puller tires moving at high speed in opposite directions.



Quad Pullers
-Typical View

Machine Display

The Machine Display is the central control center of the machine. In addition, it is used for programming detasseling heads to control tool bar functions, such as:

- Lift/Motor Control (Auto/Manual Mode)
- Depth Command
- Light Sensing
- Calibration



Machine Display
-Typical View



Lift Icon Buttons (All Up/Down)
(Located on the Machine Display
DTB Lifts/Motors Screen)
-Typical View

All Up/Down Switch

The All Up/Down Switch (located on the Hydrostatic Drive Control Handle) is used to raise or lower all lifts simultaneously. In addition, the same all up/down function can be controlled by pressing the Lift Icon Buttons - UP/DOWN (located on the Machine Display “DTB Lifts/Motors” screen).

Outrigger Fold Switches

(Left/Right)

The hydraulic Outrigger Fold Switches (located on the Hydrostatic Drive Control Handle) are used to hydraulically fold/unfold the outriggers.



All Up/Down Switch
(Located on the Hydrostatic
Drive Control Handle)
-Typical View



Outrigger Fold Switches - Left/Right
(Located on the Hydrostatic
Drive Control Handle)
-Typical View

Main Motor Switch

The detasseling head motors are controlled by the Main Motor Switch (located on the Hydrostatic Drive Control Handle). This switch must be in the ON position to enable detasseling head operation.



Main Motor Switch
(Located on the Hydrostatic
Drive Control Handle)
-Typical View

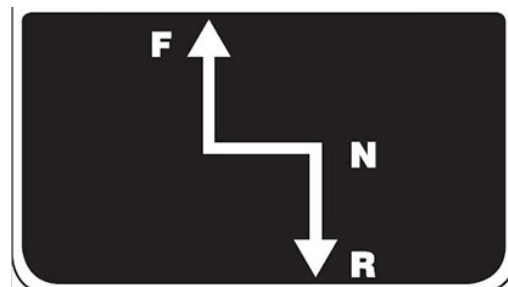

Hydrostatic Drive Control Handle
-Typical View

FOLD PROCEDURE - DETASSELER TOOL BAR

WARNING

Before proceeding, check area around the machine for bystanders, overhead objects, and power lines. Failure to comply may result in serious injury or death.

Unfolding the Tool Bar

(From storage position)

1. Ensure the Hydrostatic Drive Control Handle is in the NEUTRAL position.

2. Engage the parking brake.
3. Start the engine.
4. Press the Field/Road Button (located on the Machine Display “DTB Lifts/Motors” screen) and change the machine’s drive state to FIELD.

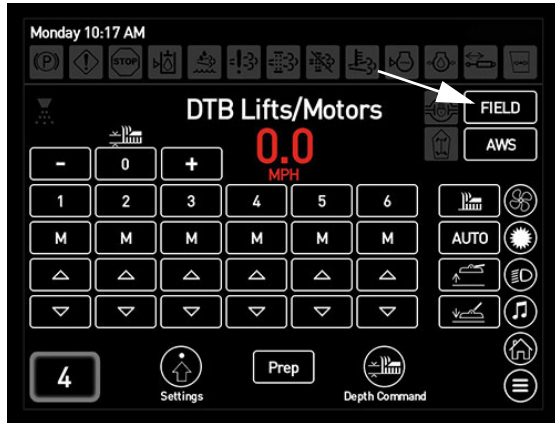

Field/Road Button
(Located on the Machine Display
DTB Lifts/Motors Screen)



4-2 Slide Extension Switch
(Located on the side console)
-Typical View

5. Press and hold the corresponding Out-
rigger Fold Switch (located on the Hydro-
static Drive Control Handle) in the OUT
(Unfold) position until outriggers fully
extend.



4-2 Detasseler Tool Bar - *if equipped*
(Extended View)

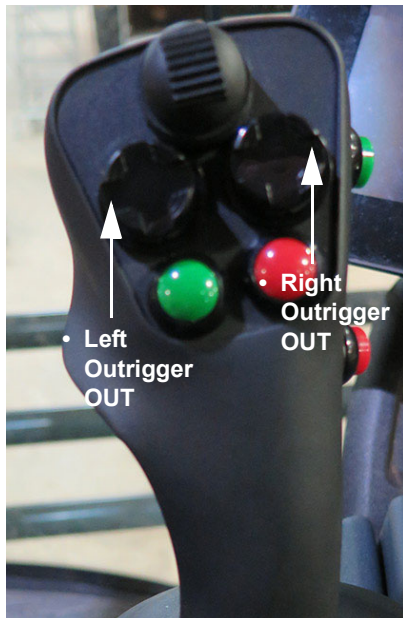

Outrigger Fold Switches - Left/Right
(Located on the Hydrostatic
Drive Control Handle)
-Typical View

**Folding the Tool Bar
(To storage position)**

NOTICE

4-2 Detasseler Tool Bar Only
Ensure the outer slide extensions are
fully retracted before folding the
outriggers in. Failure to comply will result
in property damage.

NOTICE

Stagger detasseling heads before
folding the outriggers. Failure to comply
will result in property damage. Refer to
“Transporting” in the *Miscellaneous
Section* elsewhere in this manual for
further information.

6. **If equipped with the 4-2 Detasseler
Tool Bar**, press and hold the 4-2 Slide
Extension Switch (located on the side
console) in the UP position to extend the
left and right-hand slide extensions.

1. Press the Attachment Button (located on
the Machine Display Main Menu).



Attachment Button
(Located on the Machine
Display Main Menu)

2. PREP TO FOLD - Press the Prep Button (located on the Machine Display “DTB Lifts/Motors” screen OR the “DTB Depth Command” screen).

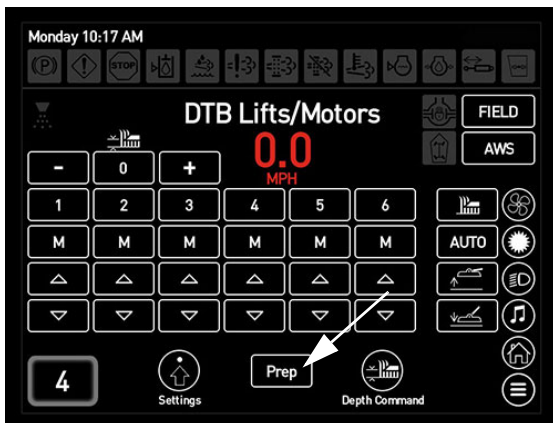

Prep Button
(Located on the Machine Display
DTB Lifts/Motors Screen or
DTB Depth Command Screen)

3. Press BOTH left and right-hand Level Switches (located on the Hydrostatic Drive Control Handle) either UP or DOWN simultaneously.
The tool bar will then adjust the lifts and the depth command actuators will position to allow folding.

NOTE: If equipped with the 4-2 Detasseler Tool Bar, the left and right-hand slide extensions will retract automatically when operating Prep-to-Fold.

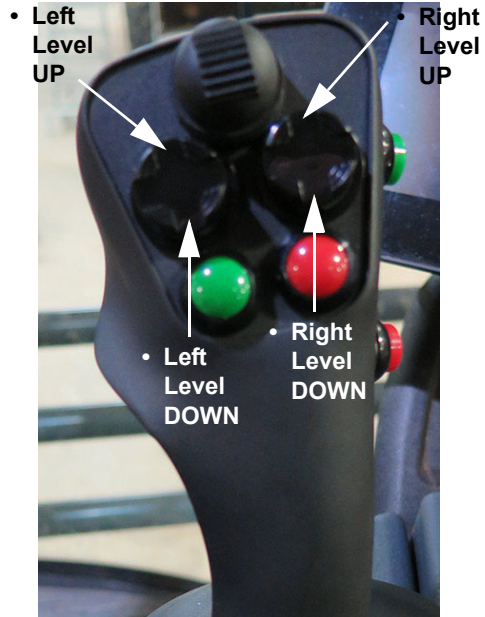

Level Switches - Left/Right
(Located on the Hydrostatic
Drive Control Handle)
-Typical View

NOTE: Once the tool bar is prepped to fold, a “DTB Prep to Fold Complete” message will appear on the display.

4. Press and hold the corresponding Outrigger Fold Switch (located on the Hydrostatic Drive Control Handle) in the IN (Fold) position until outriggers fully retract.

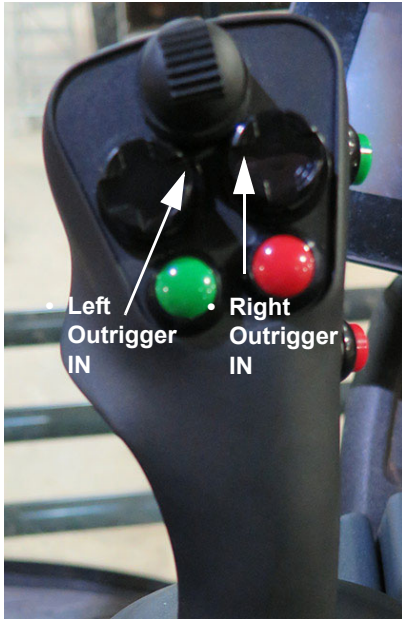

Outrigger Fold Switches - Left/Right
(Located on the Hydrostatic
Drive Control Handle)
-Typical View

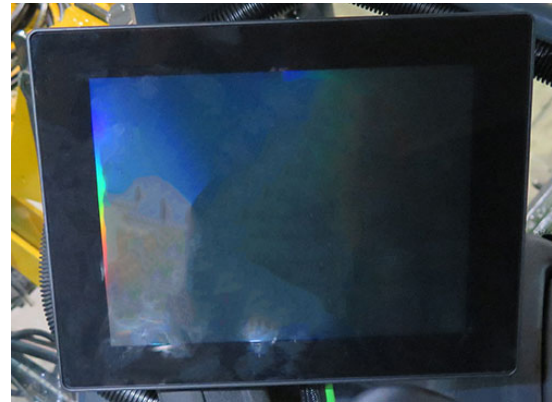

Machine Display
-Typical View

2. Ensure the Hydrostatic Drive Control Handle is in the NEUTRAL position.

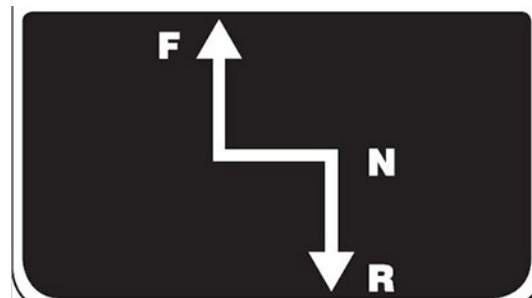

Hydrostatic Drive Control Handle
-Typical View

DETASSELING SYSTEM - OPERATION

Getting Started

1. Program the Tasselrol™ XL system through the Machine Display.
Refer to “Tasselrol XL/LS System 12” provided elsewhere in this section for further information.

3. Engage the parking brake.
4. Start the engine.

- Press the Field/Road Button (located on the Machine Display “DTB Lifts/Motors” screen) and change the machine’s drive state to FIELD.

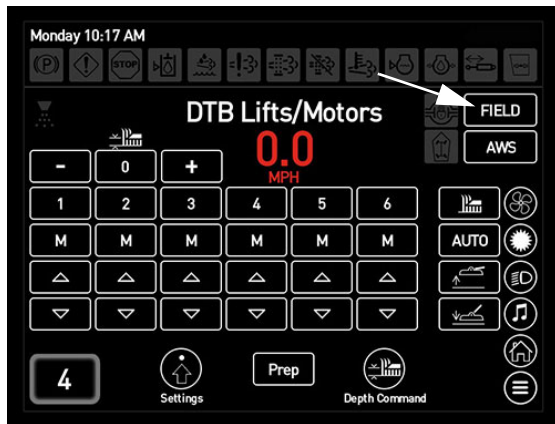

Field/Road Button
(Located on the Machine Display
DTB Lifts/Motors Screen)

- Unfold and position tool bar to desired position. Refer to “Fold Procedure - Detasseler Tool Bar” elsewhere in this section for further information.
- Press the corresponding Motor Button(s) (located on the Machine Display “DTB Lifts/Motors” screen) to turn desired detasseling head motors ON.

NOTE: Press the Motor Icon Button (next to the individual motor buttons) to activate all motors.

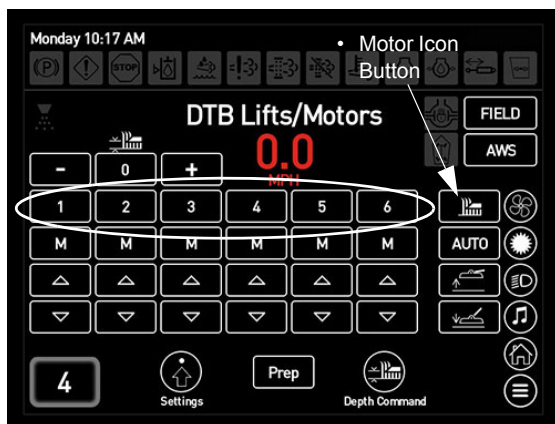

Motor Buttons (1-6)
(Located on the Machine Display
DTB Lifts/Motors Screen)

- Turn the Main Motor Switch (located on the Hydrostatic Drive Control Handle) ON.

NOTICE

If loss of hydraulic pressure occurs or the low hydraulic oil warning indicator appears on the Machine Display, shut down the system immediately. Failure to comply may result in system damage and will void the warranty.



Main Motor Switch
(Located on the Hydrostatic
Drive Control Handle)
-Typical View

- Press and hold the Throttle Switch (located near the Hydrostatic Drive Control Handle) in the UP/“rabbit icon” position to achieve the recommended RPM to operate the detasseling head motors.

NOTE: Detasseling heads will be available for immediate use by increasing engine RPM.

NOTICE

Operating the Detasseling System below the recommended 2300 engine RPM will not provide the system with adequate hydraulic oil flow and may cause degraded or poor performance.

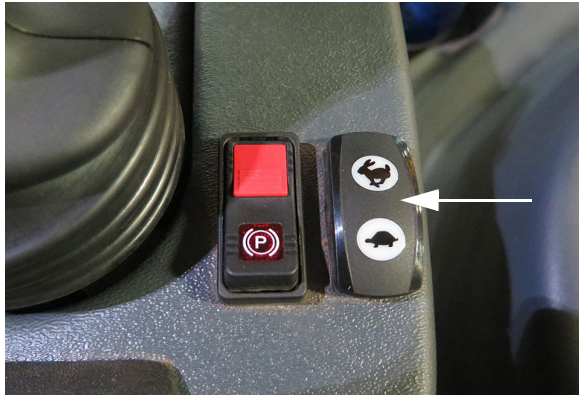

Throttle Switch
(Located near the Hydrostatic Drive Control Handle)
-Typical View

- Slowly move the Hydrostatic Drive Control Handle forward to obtain desired ground speed.

- Press the Attachment Button on the Main Menu to navigate to the “DTB Lifts/Motors” screen.



Attachment Button

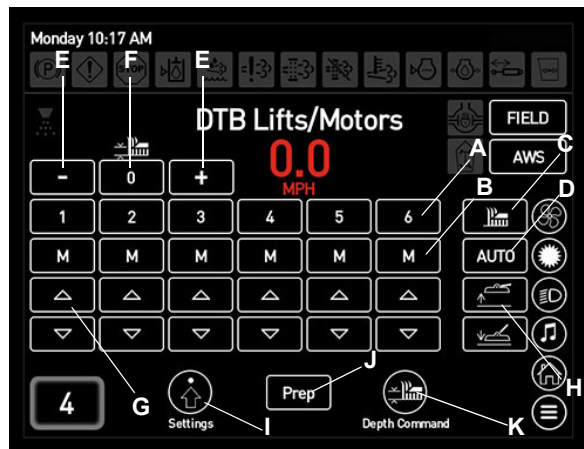

DTB Lifts/Motors Screen
(Manual Mode)

TASSELTRTM XL/LS SYSTEM 12

(Light Sensing/Depth Control)

Lifts/Motors

Manual/Auto Mode

In **MANUAL MODE**, the lifts move manually, or not using the photoeyes to adjust the lift height. In **AUTO MODE**, the lifts will automatically raise if both photoeyes are covered, and lower if the bottom photoeye is not covered.

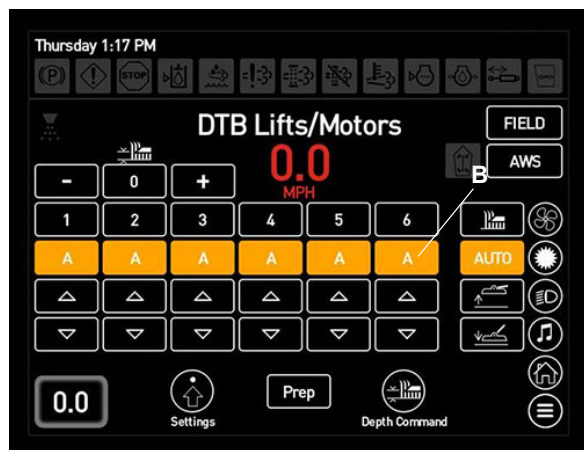

DTB Lifts/Motors Screen
(Auto Mode)

- Press Motor Buttons (1-6) **(A)** to turn desired motor(s) on/off.
- Press the M or A Button(s) **(B)** below the corresponding lift number to enable Manual or Auto mode.
- Press the Motor Icon Button **(C)** to activate all motors.
- Press the Auto Button **(D)** to enable Manual or Auto mode for all lifts.

NOTE: This button will always say “AUTO”, but will illuminate when all lifts are in Auto mode.

- Press the “-” or “+” Buttons **(E)** to increase/decrease depth command height for all lifts.

*NOTE: Press center of button **(F)** to set all depth command actuators to desired height.*

- Press and Hold the desired Up or Down Arrow Button **(G)** below the corresponding lift number to raise/lower the individual lifts.
- Press and Hold desired Lift Icon Button **(H)** (UP or DOWN) to raise/lower all lifts together.

NOTE: Same function can be done through the All Up/Down Switch (located on the hydrostatic drive control handle).

- Press the Settings Button **(I)** to navigate to the “DTB Settings” screen.
- Prep (Prep to Fold) - Press the Prep Button **(J)**, then press BOTH left and right-hand level switches (located on the hydrostatic drive control handle) either up or down simultaneously. The tool bar will then adjust the lifts and the depth command actuators will position to allow the main folds to be folded.

NOTE: If equipped with the 4-2 Detasseler Tool Bar, there will be a 10 second delay to allow the tool bar to retract.

NOTE: Once the tool bar is prepped to fold, a “DTB Prep to Fold Complete” message will appear on the display. Complete the folding procedure by pressing the corresponding left and right-hand Outrigger Fold Switches (located on the hydrostatic drive control handle).

- Press the Depth Command Button **(K)** to navigate to the “DTB Depth Command” screen.

Depth Command

- Press the “-” or “+” Buttons **(A)** to increase/decrease depth command height for all lifts.

*NOTE: Press center of button **(B)** to set all depth command actuators to desired height.*

- 1-6 row **(C)** (lift number).
- 0 row **(D)** (actual position of each depth command actuator).
- Press the desired Up/Down Arrow Button(s) **(E)** to raise/lower the corresponding depth command actuators.
- MEM (Memorize) **(F)** - Press the MEM Button to allow the system to remember the position of all photoeyes.
- MR (Memory Recall) **(G)** - Press the MR Button to allow the photoeyes to go back to the previously memorized position.
- Press the Settings Button **(H)** to navigate to the “DTB Settings” screen.
- Prep (Prep to Fold) - Press the Prep Button **(I)**, then press BOTH left and right-hand level switches (located on the hydrostatic drive control handle) either up or down simultaneously. The tool bar will then adjust the lifts and the depth command actuators will position to allow the main folds to be folded.

NOTE: If equipped with the 4-2 Detasseler Tool Bar, there will be a 10 second delay to allow the tool bar to retract.

NOTE: Once the tool bar is prepped to fold, a “DTB Prep to Fold Complete” message will appear on the display. Complete the folding procedure by pressing the corresponding left and right-hand Outrigger Fold Switches (located on the hydrostatic drive control handle).

- Press the Lift/Motors Button **(J)** to navigate to the “DTB Lifts/Motors” screen.

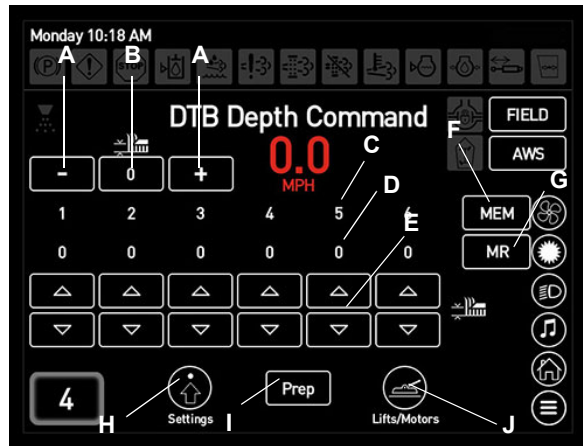

DTB Depth Command Screen

Settings

- **Lift Up Speed** - Press the Auto, Manual, or All Up Button to navigate directly to the corresponding “DTB Lift Up” screen to adjust lift speed for desired mode.
- **All Up Time** - Amount of time that the lifts will raise in the “All Up” state. Swipe left or right to decrease/increase the amount of time (in 5 second intervals) that the lifts will travel up after the All Up Switch (located on the hydrostatic drive control handle) is pressed momentarily.

NOTE: With a value of 0 seconds, the lifts will stop raising when the All Up Switch is released.

- **Response Parameter** - Time delay between a change in the photoeye status until the lift responds. A higher number means that the lift will wait longer between a change in photoeye status until that lift responds to the change.
Example: Time delay between bottom photoeye being uncovered until that lift moves down. Also, time delay between the top photoeye being covered until that lift moves up.
- **Bottom Parameter** - Quickness of response for lift to move down when the bottom photoeye is uncovered. A higher number means that the output will reach the maximum auto speed for that lift faster.

- **Top Parameter** - Quickness of response for lift to move up when the top photoeye is covered. A higher number means that the output will reach the maximum auto speed for that lift faster.
- **Auto One Tap** - When this parameter is enabled (swipe right to activate, or left to deactivate) and the lift is in Auto mode, that lift will lift up when the Lift Up Button is pressed for that lift for the “All Up Time”. To set the lift back to Auto mode, press the All Up/Down Switch (located on the hydrostatic drive control handle) in the DOWN position, or the Auto Button on the “DTB Lifts/Motors” screen.
- **CAL** - Press the Cal Button to navigate to the “Calibration” screen.

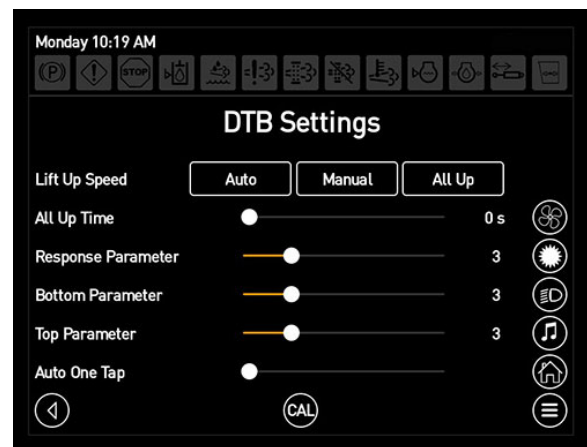

DTB Settings Screen

Lift Up (Auto)

- Each lift speed can be adjusted in Auto mode. Swipe right to increase speed, or left to decrease speed.

Lift Up (Manual)

Each lift speed can be adjusted in Manual mode. Swipe right to increase speed, or left to decrease speed.

Lift Up (All Up)

- Set All-Up speed for entire tool bar by adjusting the “All-Up Speed” (last parameter). Swipe right to increase speed, or left to decrease speed.

NOTE: Each lift can be offset from this overall speed in order to match speeds of the other lifts.

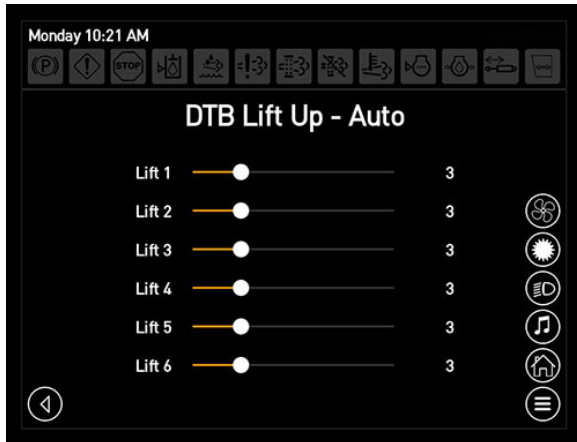

DTB Lift Up (Auto) Screen

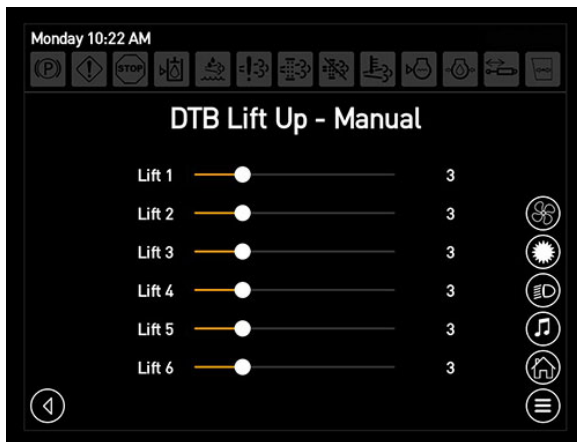

DTB Lift Up (Manual) Screen

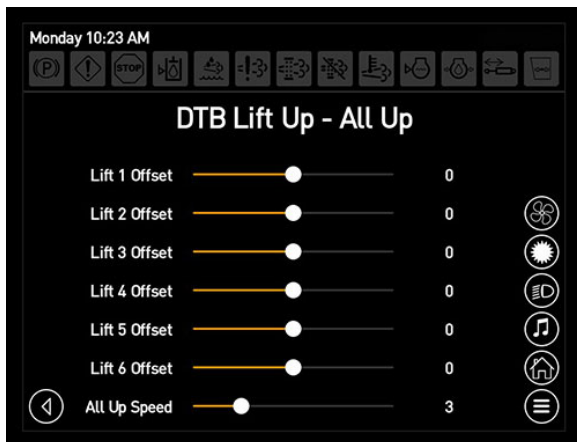

DTB Lift Up (All Up) Screen

Calibration

- Sensor Calibration - Press Depth Command UP Button **(A)** to achieve lowest

position sensor reading, then press “Set Min”.

- Press Depth Command DOWN Button **(B)** to achieve highest position sensor reading, then press “Set Max”.
- For lifts, move lifts to lowest position, then press “Set Min”. Move lifts to highest position, then press “Set Max”. Press and Hold desired Lift Icon Button **(C)** UP or DOWN to raise/lower all lifts together.

NOTE: Sensor calibration only needs to be performed if a position sensor is replaced or the position sensor is not reading correctly.

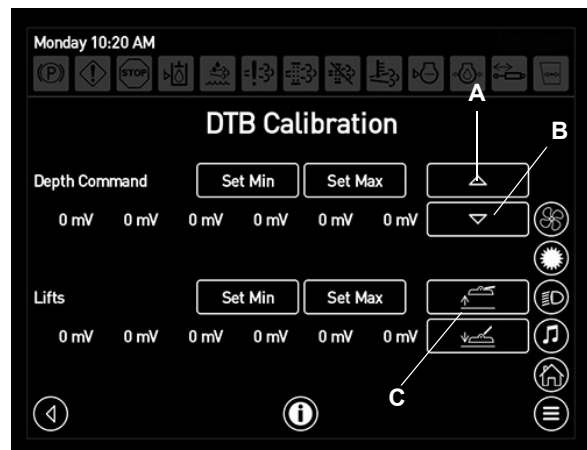

DTB Calibration Screen

ATTACHMENT ASSEMBLY

Cutter Heads, Quad Pullers, and LS (Light Sensing) System/Depth Command

⚠ CAUTION

Engage the parking brake and turn the engine OFF before installing components.

NOTICE

Read and comply with the following attachment instructions. Ensure you have the proper equipment and assistance when installing an attachment.

To ensure proper component installation, refer to your Parts Manual for outlining the installation, hydraulic schematic, and wiring diagrams.

NOTE: Refer to your Parts Manual for correct hardware used when performing the following attachment procedures.

Cutter Head Assembly



CAUTION

SEVERING OF FINGERS OR HAND.
DO NOT PLACE FINGERS OR HAND NEAR A MOVING CUTTER BLADE, ATTEMPT TO STOP A MOVING CUTTER BLADE, OR PERFORM MAINTENANCE NEAR A MOVING CUTTER BLADE.

NOTICE

Cutting Blades Must Operate in Correct Direction

Blade Rotation
Left of Operation

Front
↑

Blade Rotation
Right of Operation

650303

NOTE: Refer to your Parts Manual for specific hardware used.

1. Install two (2) Cutter Heads on each lift head tube, as shown.

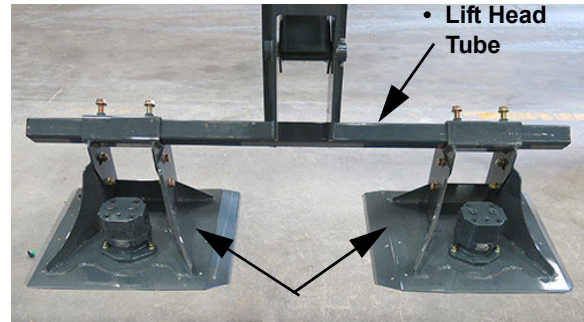

Cutter Heads
-Typical View

2. Ensure each Cutter Head measures 16” (40.6 cm) from the outside of the mount head to the outside of the cutter head mounting tube, making adjustments as necessary.

NOTE: Distance may vary depending on planting pattern.

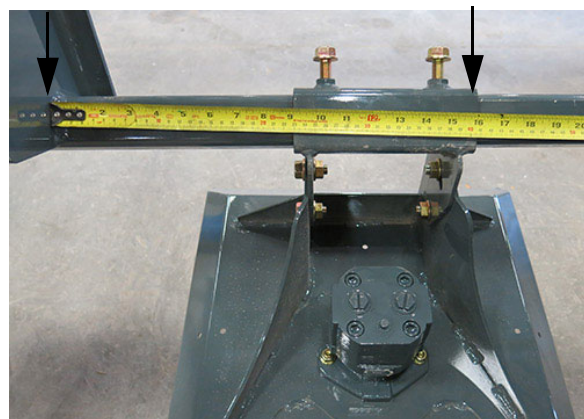

- Measure 16” (40.6 cm) from the outside of the mount head to the outside of the cutter head mounting tube

3. Ensure each Cutter Head measures 30” (76.2 cm) from center of each cutter head motor.

NOTE: Distance may vary depending on planting pattern.

NOTE: Repeat process, measuring across each lift mount.



- Measure 30" (76.2 cm) from center of each cutter head motor



- Measure 30" (76.2 cm) from center of each cutter head motor, across each lift mount

- Using a 3/4" socket, tighten each Cutter Head Bolt (two on each Cutter Head Mounting Tube).



Cutter Head Bolts
(Located on each
Cutter Head Mounting Tube)
-Typical View

- Install two Stalk Guides on each Cutter Head, positioned as shown.

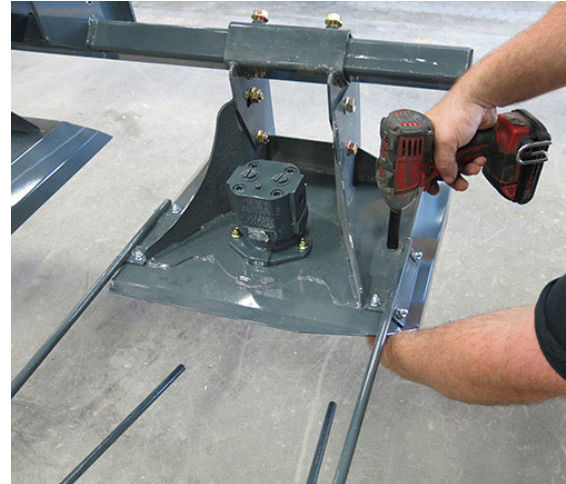

- Install eight (8) Stalk Guide Bolts (4 each side) through bottom of each Cutter Head/Stalk Guide.
- Install eight (8) Stalk Guide Nuts (4 each side) onto the bolts and tighten with a 7/16" socket.



Stalk Guide Installation
-Typical View

- Apply anti-seize lubricant to inside of Cutter Blade Adapter Plug.

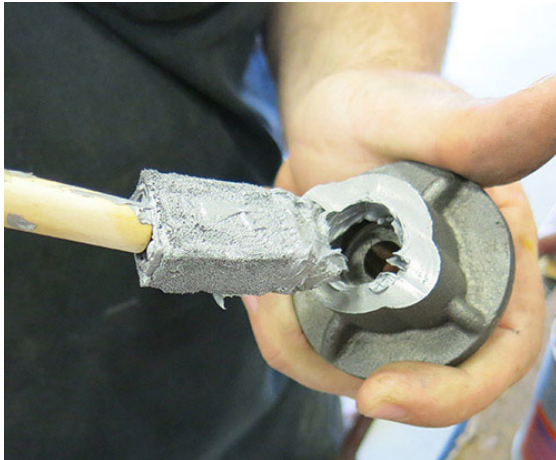

Anti-Seize Lubricant Application
-Typical View

7. Install Cutter Blade Adapter Plug onto center of blade.

NOTE: Ensure adapter plug is installed on the “edged” side of blade, as shown.



- Install Cutter Blade Adapter Plug onto center of blade

8. Assemble Retaining Bolt, Lock Washer, and Steel Washer together, as shown.

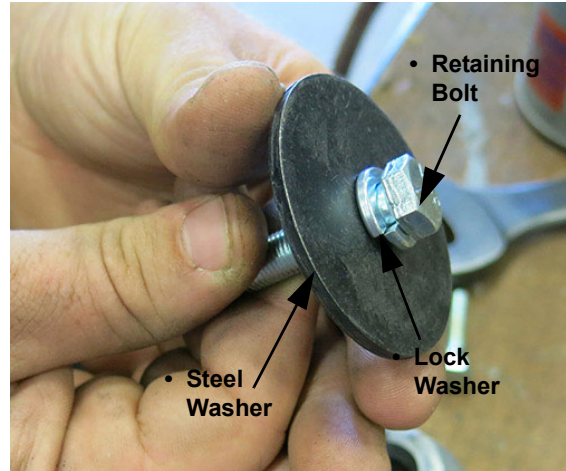

Cutter Blade Bolt/Washer Assembly
-Typical View

9. Insert Cutter Blade Bolt/Washer Assembly through bottom of blade/adapter plug.

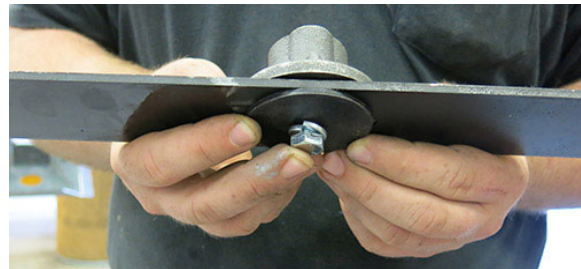

Cutter Blade Assembly
-Typical View

10. Install Cutter Blade Assembly through bottom side of Cutter Head (as shown) and tighten Retaining Bolt using a 9/16” socket. Torque to 37 ft.-lbs.

NOTE: Inspect and tighten Retaining Bolts daily.



Cutter Blade Assembly
(Mounted on the bottom
side of Cutter Head)
-Typical View

NOTE: Repeat Steps 6-10 for each Cutter Head.

11. Install Cutter Head Extension Flap on the rear side of the center four (4) Cutter Heads.



Cutter Head Extension Flap
-Typical View

12. Install hydraulic connections on each Cutter Head.

NOTE: Refer to your Parts Manual for correct hardware, hose lengths, and hydraulic schematics.



Cutter Head Hydraulic Connections
-Typical View

Quad Puller Assembly

NOTE: Some Quad Pullers may come pre-assembled to the tool bar.



CAUTION

RISK OF INJURY FROM ROTATING TIRES.
DO NOT PLACE FINGERS OR HAND NEAR MOVING QUAD PULLER TIRES, DISLodge A WEDGED OBJECT FROM MOVING TIRES, OR PERFORM MAINTENANCE NEAR MOVING TIRES.

NOTICE

Ensure quad puller tires have equal pressure. Check tire pressure daily.

NOTE: Refer to your Parts Manual for specific hardware used.

SECTION 7 – DETASSELING SYSTEMS



1. Install two (2) Quad Pullers on each lift head tube, as shown.



Quad Puller
-Typical View

2. Ensure each Quad Puller measures 16" (40.6 cm) from the outside of the mount head to the outside of the quad puller mounting tube, making adjustments as necessary.

NOTE: Distance may vary depending on planting pattern.

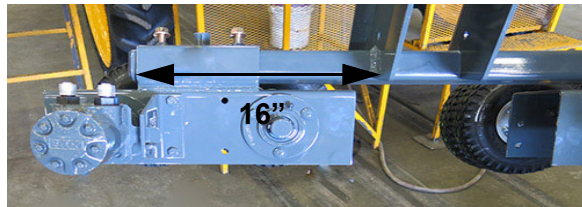

- Measure 16" (40.6 cm) from the outside of the mount head to the outside of the quad puller mounting tube

3. Using a 3/4" socket, tighten each Quad Puller Bolt (two on each Quad Puller Mounting Tube).

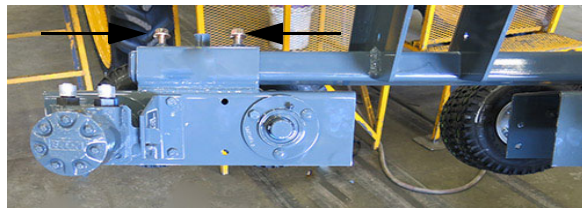

Quad Puller Bolts
(Located on each
Quad Puller Mounting Tube)
-Typical View

4. Install two Stalk Guides onto each Quad Puller, positioned as shown.
 - Install four (4) Stalk Guide Bolts (2 each side) through the front side of each Stalk Guide/Quad Puller.

- Install four (4) Stalk Guide Nuts (2 each side) onto the bolts and tighten with a 9/16" socket.

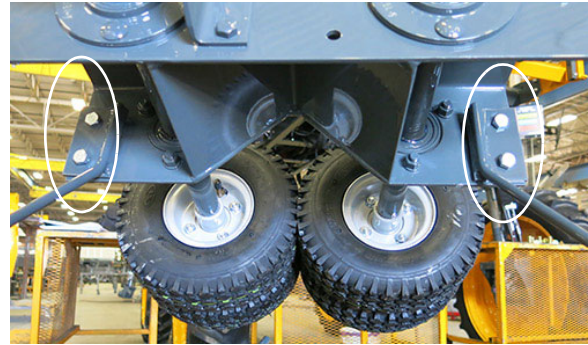

- Install four (4) Stalk Guide Bolts through the front side of each Stalk Guide/Quad Puller



- Install four (4) Stalk Guide Nuts onto the bolts and tighten with a 9/16" wrench



Stalk Guide Installation
-Typical View

5. Install Deflector Shield Mounting Tube onto each Quad Puller (as shown) and tighten bolts with 7/16" wrench.



Deflector Shield Mounting Tube
-Typical View

6. Install Deflector Shield onto Deflector Shield Mounting Tube and tighten bolts with 1/2" wrench.

NOTE: Always mount Deflector Shields to direct tassels away from machine.

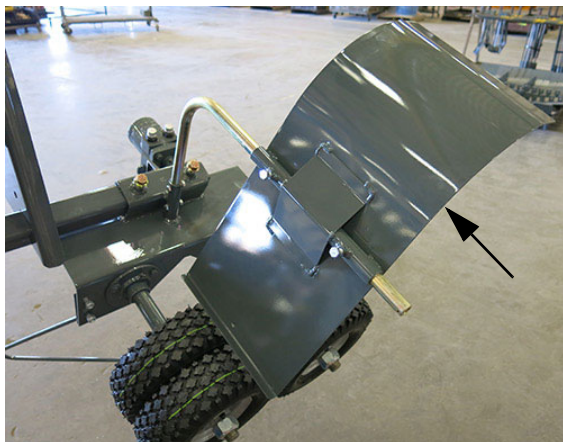

Deflector Shield
-Typical View

7. Install Cotter Pin on the end of each Deflector Shield Mounting Tube.



Cotter Pin
-Typical View

8. Install hydraulic connections on each Quad Puller.

NOTE: Refer to your Parts Manual for correct hardware, hose lengths, and hydraulic schematics.

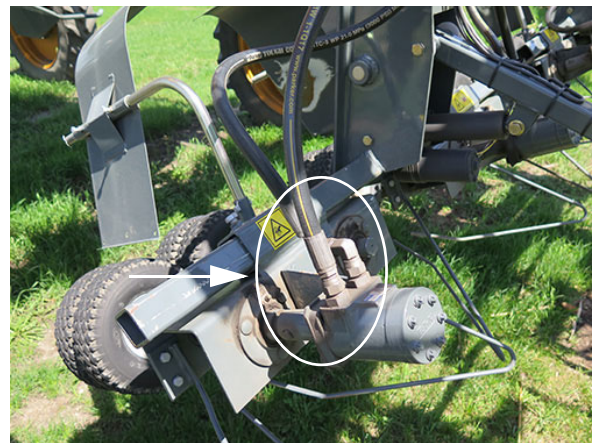

Quad Puller Hydraulic Connections
-Typical View

9. Adjust tire pressure to approximately 10 psi (.7 bar).

**LS (Light Sensing) System/
Depth Command Assembly**

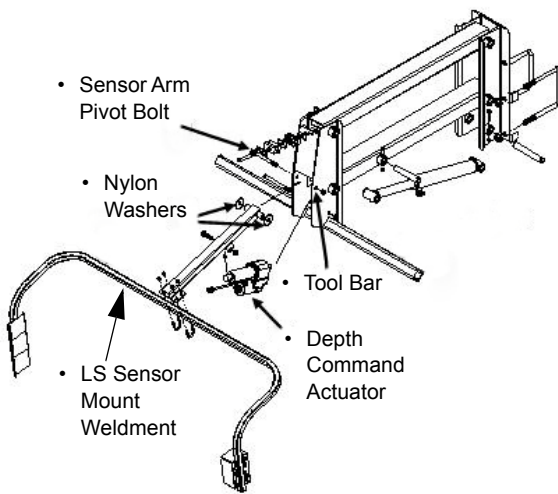

-Typical View

1. Install the LS Sensor Mount Weldment with the two Nylon Washers in the forward-most hole of the Tool Bar.
2. Install the LS Sensor Mount Weldment to the Sensor Mount (located on the support arm).
3. Install the Cable Assembly according to the wiring diagram provided in your Parts Manual.
4. Check sensor installation by turning the ignition key to the ON position. DO NOT start the engine.
5. Attach the Depth Command Actuator to the Light Sensor Mount and Tool Bar.

NOTICE

Over-tightening of the Sensor Arm Pivot Bolt may cause the actuator to stall.



SECTION 8 – MAINTENANCE AND STORAGE



Hagie Manufacturing Company LLC
P.O. Box 273 • Clarion, IA 50525-0273
Hagiehelp.com

LUBRICATION RECOMMENDATIONS			
COMPONENT	GENERAL SPECIFICATION	RECOMMENDED LUBRICANT	RECOMMENDED SERVICE INTERVAL
Engine Oil	API CJ-4 15W-40	JD Plus-50 II 15W40	Change at 500 hours to JD Plus-50 II
Engine Coolant	ASTM D6210 Nitrite free	John Deere Cool Gard II EG 50/50 mix	2000 Hours or 2 Years
Hydraulic Oil	ISO 11158, Type HM/HV, VG 46	John Deere Hy-Gard™	Oil Analysis Guidance or Change at 1000 Hours
Planetary/Hub Drives	Synthetic API GL-5/MT-1	Mobil Delvac Synthetic Gear Oil 75W-90	Oil Analysis Guidance or 250 hours/Yearly
Greased Points	NLGI, EP, ISO 220	SD Polyurea	Daily

PLEASE CONSULT MANUAL FOR FURTHER DETAILS

650780

NOTICE

Pump repair and replacement should be performed by qualified service personnel only. Replace with properly rated components. Refer to your parts manual for further information.

NOTICE

Refer to your parts manual when replacing hydraulic hoses to ensure you have the correct pressure rated hose.

SERVICE - FLUIDS

Hydraulic Oil

NOTICE

Ensure area is clean before changing hydraulic oil and filters to avoid contamination, such as dirt and debris. Failure to comply may result in severe hydraulic system damage.

NOTICE

Ensure engine is off before filling hydraulic oil reservoir.

Check the Hydraulic Oil Reservoir Sight Gauge level daily. Add just enough fluid to maintain oil level at mid-sight gauge.

NOTE: Hydraulic oil expands when heated. Always check oil level when it is cool.

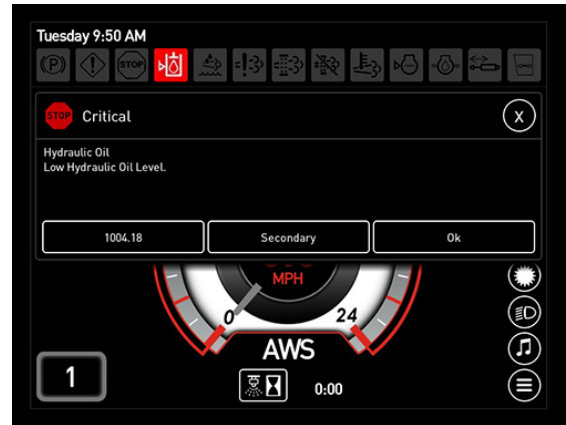
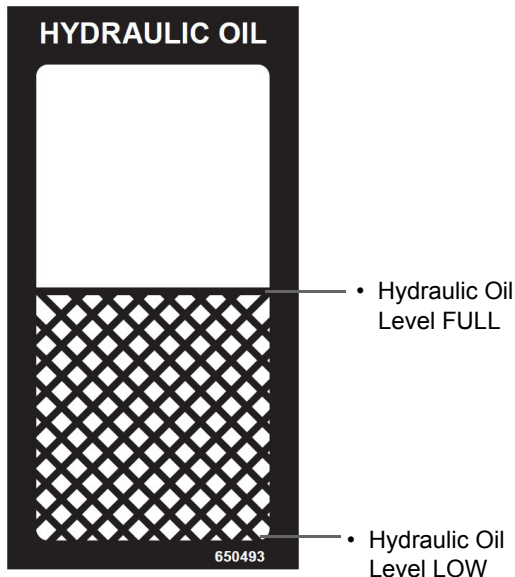

Low Hydraulic Oil Level Warning Message
(Located on the Machine Display)

NOTE: Replace hydraulic oil every 1,000 hours of operation.

Filling the Hydraulic Oil Reservoir



Hydraulic Oil Reservoir Sight Gauge
(Located near the rear left-hand side of machine)
-Typical View

If hydraulic oil level is too low for safe operation, a warning message will appear on the Machine Display to alert you of low hydraulic oil level. Press OK to acknowledge, shut down the engine immediately, and refill reservoir to proper level to avoid damage to the hydraulic systems.

NOTICE

Ensure all lifts are fully raised and tool bar folded, wheel tread fully retracted, and all wheels straight before filling the hydraulic oil reservoir. Failure to comply may result in over or under filling of the hydraulic oil reservoir and inaccurate sight gauge reading.

Capacity

- 25 gallons (94.5L)

Type

- John Deere Hy-Gard™ Hydraulic Oil

Hydraulic oil can be added two different ways:

1. Through the hydraulic oil fill port (located on the side of the hydraulic return filter housing); or
2. Through the top of the hydraulic return filter housing. Remove bolts and cover to access.

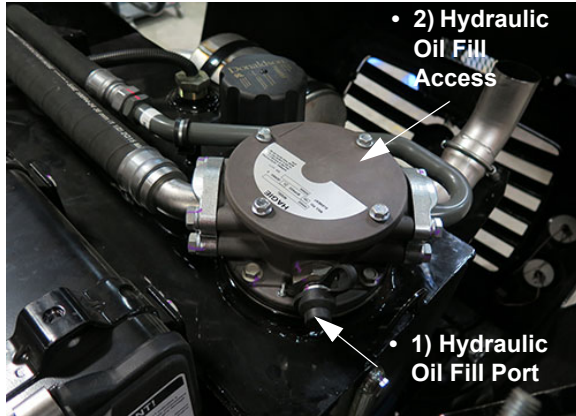

Hydraulic Oil Fill Options
-Typical View

Method 1 - Filling Through Hydraulic Oil Fill Port (Preferred Method)

NOTE: A hydraulic oil pump is required to fill through the hydraulic oil fill port, as gravity will not work and there is a small pressure to be overcome.

NOTE: Two (2) quick coupler fittings are provided in your tool kit to provide connection between the hydraulic oil fill port and the hydraulic oil pump that you are using.

- Remove the fill port rubber end cap.
- Attach hydraulic oil pump quick-connect fitting to the hydraulic oil fill port.
- Slowly squeeze pump handle and fill reservoir until oil level reaches mid-sight gauge.



Filling Tank Through Hydraulic Oil Fill Port
-Typical View

- When finished filling, release pump handle and disconnect quick-connect fitting from fill port.
- Reinstall fill port rubber end cap.

Method 2 - Filling Through Hydraulic Return Filter Housing

NOTE: Clean dirt/debris from return filter housing cover before removing.

- Using a 1/2" wrench, remove the four (4) bolts (located on top of the hydraulic return filter housing) and set aside.
- Remove cover and fill reservoir until oil level reaches mid-sight gauge.



Filling Tank Through Hydraulic
Return Filter Housing
-Typical View

- When finished filling, reinstall hydraulic return filter housing cover and bolts.

Wheel Hub Oil

Each wheel hub should maintain a proper oil level at all times. Less than that would limit lubrication and overfilling would cause overheating and gear box damage.

Capacity

- 27 oz. (.8L)/each

Type

- Hagie Manufacturing Company recommends Mobil Delvac™ synthetic gear oil (75W-90) with EP features (complying with API GL-5/MT-1 specifications).

To check the oil level:

NOTE: Check wheel hub oil level every 100 hours of operation.

SECTION 8 – MAINTENANCE AND STORAGE



1. Position wheel hub so the bottom (oil check/drain) face plug is positioned at 6 o'clock (C).

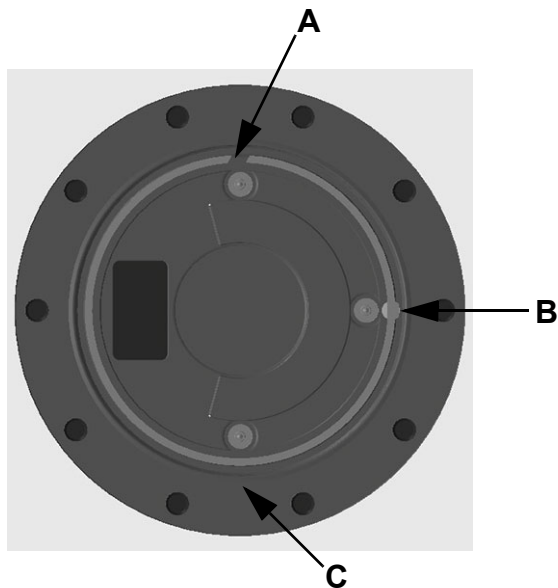
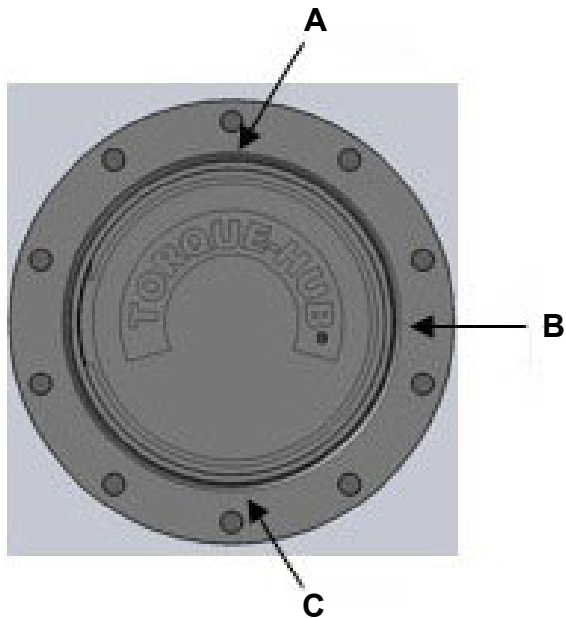

2. Using a 1/4" ball end Allen wrench, remove the 3 o'clock plug (B). If no oil comes out, proceed to Step 3.
- NOTE: If oil is present, wheel hub oil level fill is satisfactory.*
3. If oil is needed, remove the top SAE #6 o-ring plug (A) (**1/4" ball end Allen wrench required to obtain clearance of wheel hub stud**) and fill until oil

begins to come out of the 3 o'clock plug (B).



-Typical View

4. Reinstall plugs and torque to 35 ft.-lbs.

To change the oil:

NOTE: Wheel hub oil should be changed after the first 50 hours of operation. After that, it should be changed every 250 hours of operation or yearly, whichever occurs first.

1. Position wheel hub so one of the radial face plugs is positioned at 6 o'clock (C) and the other radial face plug is positioned at either the 3 or 9 o'clock positions.
2. Using a 1/4" ball end Allen wrench, remove plugs to drain oil.

NOTE: You may only need to break the 3 or 9 o'clock plugs to allow air entrapment to escape.

3. Once all of the oil is drained, reinstall the bottom plug (C) using a 1/4" ball end Allen wrench.
4. Rotate wheel hub to the "fill" position - one radial face plug at 12 o'clock (A), and a second plug positioned at either the 3 or 9 o'clock positions.
5. Refill wheel hub with oil until satisfactory level is met.
6. Reinstall all radial face plugs and torque to 35 ft.-lbs.

General Maintenance**NOTICE**

Failure to rotate the wheel hub and disperse oil may cause rusting and internal wheel hub damage.

If your machine is going to sit unused for an extended period of time, occasionally rotate the wheel hubs by driving the machine forward and backward - at least half of a tire rotation to adequately coat all internal wheel hub parts. This will prevent rusting if moisture inadvertently entered the wheel hub during an oil change.

Engine Oil**NOTICE**

Never operate the engine with oil level below the “L” (low) mark or above the “H” (high) mark on the engine oil dipstick.

NOTICE

The engine must be level when checking oil level to ensure accuracy.

The Engine Oil Dipstick is located on the left-hand side of the engine (through service access opening). Wait at least five (5) minutes after shutting the engine off to check the oil level.

NOTE: Check the engine oil level daily.

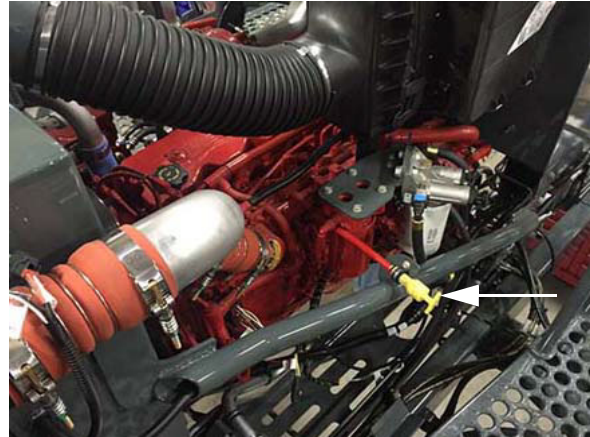

Engine Oil Dipstick
(Located on left-hand side of engine
through service access opening)
-Typical View

Capacity

- Engine Oil Dipstick (low to high mark capacity) = 2 quarts (1.9L)
- Engine Oil Pan Capacity (including filter and cooler) = 17.6 quarts (16.7L)

Type

- John Deere Plus-50™ II Premium Engine Oil

NOTE: Change the engine oil every 500 hours of operation or yearly, whichever occurs first.



Engine Oil Fill
(Located near top of engine -
open hood to access)
-Typical View

**Diesel Exhaust Fluid (DEF)
(Final Tier 4 Engines)**

engine will either be locked at idle or will shut down. Refer to the engine manufacturer’s service manual for information on how to recover from a low DEF level condition.

⚠ WARNING

Read the DEF manufacturer’s label and comply with safety precautions to avoid injury or damage.

NOTICE

Never operate the engine with low DEF level. If DEF reaches a level that is too low for safe operation, the engine will begin to derate.

NOTICE

Ensure engine is off before filling the DEF tank.



DEF Gauge
(Located on cab A-post)
-Typical View

Check the DEF Gauge (located on the cab A-post or on the Machine Display “Engine Diagnostics” screen) daily. Add just enough DEF to keep the DEF tank full.

DEF Indicator Lamp Status
<ul style="list-style-type: none"> When DEF level reaches 10% (indicated on the DEF Gauge), DEF Indicator Lamp will illuminate.
<ul style="list-style-type: none"> When DEF level drops to 5%, DEF Indicator Lamp will flash.
<ul style="list-style-type: none"> When DEF level drops to 2.5%, initial engine derate begins.
<ul style="list-style-type: none"> When DEF level drops to 0%, secondary engine derate begins.

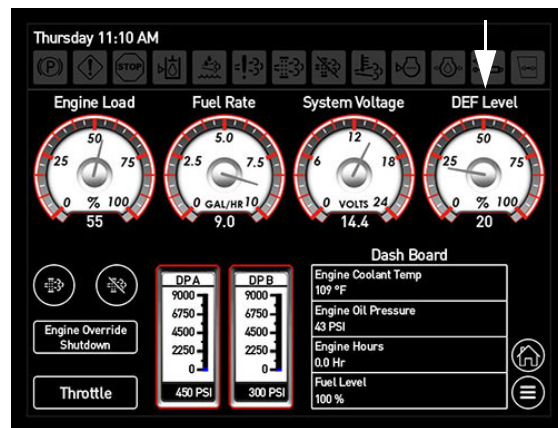

DEF Gauge
(Located on the Machine Display -
Engine Diagnostics Screen)
-Typical View

NOTE: Depending on the selected final inducement option, 30 minutes after the DEF Gauge reads 0%, the

Capacity

- DEF Tank Capacity = 5 Gallons (18.9L)

Type

- Use only DEF which meet ISO 2224101 standards.

NOTE: John Deere Diesel Exhaust Fluid recommended.

NOTE: Refill tank with DEF every other fuel fill to maintain adequate fluid level.

Filling the DEF Tank

Refer to “Engine Aftertreatment - Final Tier 4” provided in the *Engine and Drive Systems Section* elsewhere in this manual for further information.

DEF Storage

DEF has a limited shelf life, both in the machine’s DEF tank and in storage containers. The following conditions are ideal for maintaining DEF quality and shelf life during prolonged transportation and storage:

- Store DEF between 23° F (-5° C) and 77° F (25° C).
- Store DEF in sealed containers to avoid contamination.
- Avoid direct sunlight.

By following these conditions, DEF has a minimum expected shelf life of approximately 18 months.

NOTE: When storing DEF in higher temperatures for an extended period of time, the shelf life will be reduced by approximately 6 months for every 9° F (5° C) above the highest storage temperature as previously listed.

Long-term DEF storage in a machine (in excess of 6 months) is not recommended. If long-term storage is necessary, periodic testing of the DEF is recommended to ensure adequate concentration. Having the correct concentration of DEF is critical in engine and aftertreatment system performance.

NOTE: To help prevent DEF deterioration when stored in the DEF tank, locate and plug the tank venting to seal tank exposure against environmental elements.

Checking DEF Concentration

DEF concentration should be checked when the machine has been stored for an extended period of time or if it is suspected that water has been added to the DEF tank.

- Use a refractometer to check DEF concentration.

NOTE: Refer to the engine manufacturer’s operation manual for further information on checking DEF concentration.

- If the DEF concentration is found to be inadequate (outside of recommended specification):
 1. Drain the DEF tank.
 2. Flush tank with distilled water.
 3. Refill tank with new DEF.
 4. Recheck DEF concentration.

Freezing

 CAUTION
DO NOT add any chemicals/additives to the DEF in an effort to prevent freezing. If chemicals/additives are added to the DEF, the Aftertreatment System may become damaged.

DEF will freeze around 12° F (-11° C). The DEF system on the machine is designed to accommodate this and does not require any operator intervention.

DEF Disposal

Check with local authority regulations on proper DEF disposal requirements.

Cooling System

NOTICE
Do not use coolants that contain nitrite additives.

SECTION 8 – MAINTENANCE AND STORAGE



The cooling system should be sufficiently charged with an adequate mixture of antifreeze and water, regardless of climate, to maintain broad operating temperature range. Follow the coolant manufacturer's recommendations for your climate.

NOTE: The cooling system has been factory-filled with an ethylene glycol-based antifreeze.

Capacity

Final Tier 4 Engine

- 10 gallons/37.5L

Tier 3 Engine (Export only)

- 9.55 gallons/36.2L (Export only)

Type

- John Deere Cool -Gard™ II Engine Coolant

Checking Coolant Level/ Concentration



Check coolant level daily. Ensure fluid level is visible within the Coolant Sight Gauge (located on the right-hand side of hood). Coolant level is low if fluid is not seen in the sight gauge.



Coolant Sight Gauge
(Located on the right-hand side of hood)
-Typical View

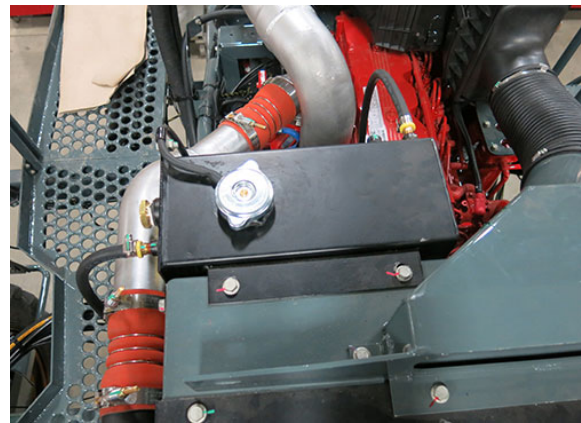

Radiator
(Located near the rear of machine - open hood to access)
-Typical View

A 50/50 ethylene glycol and water mixture is a conservative mixture, which allows protection against both overheating and freezing.

NOTE: If a stronger antifreeze mixture is required, ensure not to exceed the engine manufacturer's guidelines for antifreeze-water mixing. Refer to "ASTM D 6210" or "ASTM D 7715" standards for further information.

The following Ethylene Glycol Table gives a few examples of ethylene glycol antifreeze/water mixture protection values.

Ethylene Glycol		
40%	-23° C	-10° F
50%	-37° C	-34° F
60%	-54° C	-65° F

Coolant concentration should be checked every 500 hours of operation or at the beginning of each spray season, whichever occurs first. A refractometer should be used to check concentration.

NOTE: “Floating Ball” type density testers are not accurate for use with a heavy duty diesel cooling system.

Changing Coolant

⚠ CAUTION

COOLING SYSTEM REQUIRES SPECIAL FILL PROCEDURE

- Open cab heater water valve by turning the cab temperature knob to “Heat” with ignition on.
- Fill radiator to bottom of fill neck using 50/50 EG coolant mixture.
- If radiator is drained completely and refilled faster than 3 gpm (11.4 l/min), radiator may need to be topped off.
- Run engine at operating temperature for 5 minutes.
- Shut off engine.
- Wait until coolant is below 122° F before removing cap to check coolant level.
- Top off cooling system if required.
- See operator’s manual for total cooling system volume.

Coolant should be changed periodically to eliminate the buildup of harmful chemicals. Drain and replace the coolant every other spray season or 1,000 hours of operation, whichever occurs first. Refill with soft water only, as hard water contains minerals, which break down the anti-corrosion properties of the antifreeze.

Further Information

Refer to the engine manufacturer’s operation manual for further information.

Engine Fuel

⚠ CAUTION

DIESEL FUEL CAN BE DANGEROUS

- Turn off engine before refueling.
- Do not smoke while refueling.
- Clear off any spilled fuel after refueling.

NOTE: Keep a fire extinguisher nearby when refueling.

DO NOT fill fuel tank completely. Fuel can expand and run over. Wipe up all spilled fuel and clean with detergent and water before starting the engine.

Capacity

- Fuel Tank Capacity = 100 gal. (378.5L)

Type

Final Tier 4 Engine

- Ultra-Low Sulfur Diesel (ULSD) fuel required.

Tier 3 Engine (Export only)

- No. 2 diesel fuel recommended. (In operating conditions less than 32° F., use a blend of No. 1 and No. 2 diesel fuel).

NOTE: The addition of No. 1 diesel fuel may cause loss of power and/or fuel economy.

Filling the Fuel Tank

1. Shut the engine off.
2. Remove Fuel Fill Cap and set aside.



Fuel Fill Cap
(Located on top of fuel-rinse module)
-Typical View

3. Fill tank to desired level.
4. Reinstall the Fuel Fill Cap.

Air Conditioning

NOTICE

Charge with R-134A only. Charge to 3.50 lbs.

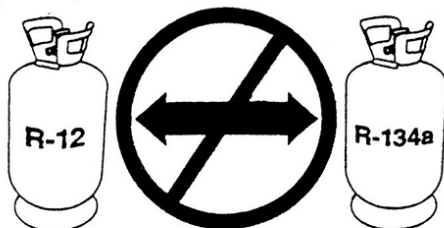

DO NOT MIX REFRIGERANTS

Recharging the AC System

The cab is equipped with an R-134A Air Conditioning System. **Recharge system with R-134A refrigerant only.**

NOTE: Confirm refrigerant before recharging the Air Conditioning System. If your system is mistakenly recharged with R-12 refrigerant,

machine damage (such as compressor seizure) may result. If you do not have the proper equipment, it is recommended that you allow an authorized service technician service your Air Conditioning System.

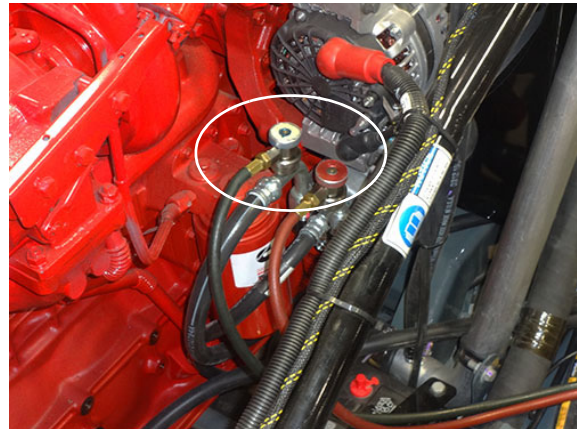

A/C Charge Ports
(Located on right-hand side of engine)
-Typical View

Windshield Washer Fluid

The Windshield Washer Fluid Reservoir is located within the fuel-rinse module (FRM). The reservoir fill cap is conveniently located on top of the right-hand FRM.

Check fluid level before each use and fill with non-freezing automotive windshield washer fluid as required.



Windshield Washer Fluid Reservoir Fill
(Located on top of the right-hand FRM)
-Typical View

SERVICE - FILTERS

Engine Air Intake

The Engine Air Intake Filter is located along the platform on the left-hand side of machine (open hood to access).



Engine Air Intake Filter
(Located along platform on left-hand side
of machine - open hood to access)
-Typical View

NOTICE

Do not tap filter to remove dust. A crushed filter caused by tapping may result in engine damage. Remove and replace filter as recommended.

Removal

The Engine Air Intake Filter should only be removed if replacement is required.

- Loosen the air pre-cleaner and remove end cap.
- Remove filter. Use care when removing the filter to ensure dust from the filter does not enter the air intake passage.

NOTE: The secondary filter does not need to be replaced if the primary filter is intact.

Replacement

Your machine is equipped with a Filter Minder® to notify you of filter element efficiency.

Cleaning

It is not recommended to clean the Engine Air Intake Filter element. However, a clean damp cloth should be used to wipe away dust and debris from the air cleaner housing.

Filter Minder

The Filter Minder is an air restriction monitoring system that progressively and constantly indicates how much air filter capacity remains to aid in achieving best preventative maintenance practices by ensuring air filter replacement only occurs when necessary.

NOTE: An air filter service interval message will appear on the Machine Display notifying you that the engine air filter is restricted and that filter replacement is recommended.

Radiator Screen

NOTICE

Failure to keep cooling systems clean can cause overheating and damage to the engine and hydrostatic systems.

To maintain adequate airflow through the engine cooling system, the Radiator Screen (located ahead of rear hood) must be inspected daily and cleaned as necessary.

Cleaning the Radiator Screen (Preferred Method)

- Ensure the Hydrostatic Drive Control Handle is in the NEUTRAL position and parking brake is engaged.
- Start the engine.
- Press and hold the Throttle Switch (located near the Hydrostatic Drive Control Handle) in the UP position to throttle engine to full RPM.
- Press the Fan Reverse Button (located on the Machine Display Main Menu Page) to navigate to the “Engine Fan Control” screen.
- On the “Engine Fan Control” screen, press the Reverse Button to activate the reversible fan.
- While the fan is in reverse mode, use a whisk broom brush (or equivalent) to dislodge large debris and dirt from the Radiator Screen.
- **When finished cleaning the Radiator Screen**, press and hold the Throttle Switch in the DOWN position to decrease engine RPM.

Cleaning the Radiator Screen (Screen Removal)

Use compressed air to dislodge large debris and dirt. Water from a pressurized hose may also be used or if necessary, the screen may be soaked with soapy water and scrubbed gently with a brush.

NOTE: When cleaning the cooling fins of the radiator, oil cleaner, or A/C condenser with compressed air or water, be careful not to damage the cooling fins, which may impair cooling capabilities.

To Remove the Radiator Screen

- Remove the two (2) Engine Scoop Spring Clips (located on the top left and right-hand side of inside scoop) and set aside.

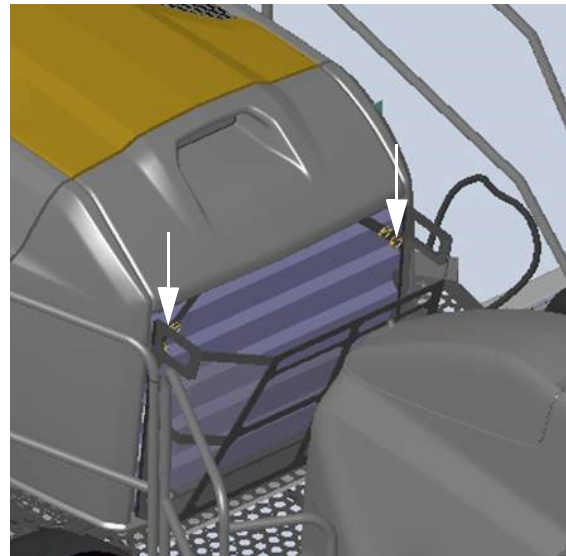

Engine Scoop Spring Clips
(Located on the top left and
right-hand side of inside scoop)
-Typical View

- Remove Engine Scoop from mounts and set aside.
- Remove the two (2) Radiator Screen Spring Clips (located on the top left and right-hand side of screen) and set aside.

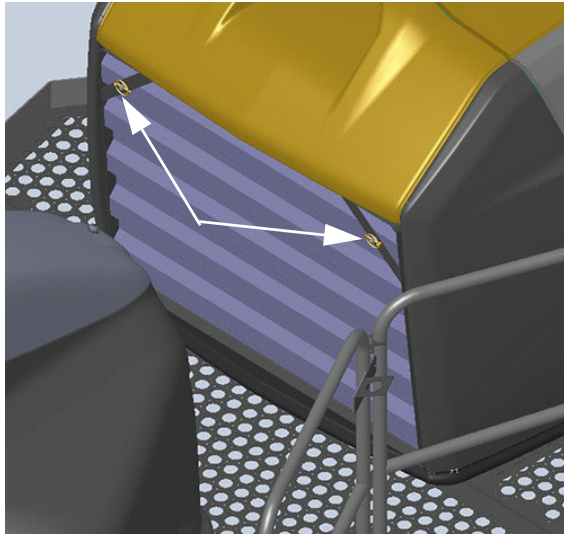

Radiator Screen Spring Clips (2)
(Located on the top left and
right-hand side of screen)
-Typical View

- Extend the top of Radiator Screen outward and lift the bottom of screen out of lower pin cradles.

To Reinstall the Radiator Screen

- At a slight angle, install the lower screen pins into the pin cradles (located near the bottom of the cooling pack), as shown in the following illustration.

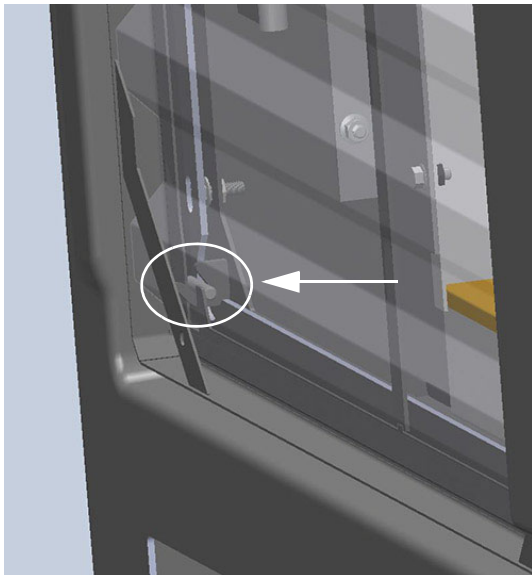

-Typical View

- Rotate screen inward until the mounting pins protrude through the screen.

- Reinstall the two (2) Radiator Screen Spring Clips.
- Reinstall Engine Scoop and Engine Scoop Spring Clips.

Hydraulic Oil Cooler Screen

NOTICE
Failure to keep the Hydraulic Oil Cooler Screen clean may result in overheating and damage to the hydraulic systems.

The Auxiliary Hydraulic Oil Cooler is located inside the FRM behind the left-hand side of cab and is equipped with a Hydraulic Oil Cooler Screen to keep dirt and debris from entering into the system and must be inspected daily and cleaned as necessary.

To Remove and Clean the Hydraulic Oil Cooler Screen

- Remove the two (2) Spring Clips (located on the Hydraulic Oil Cooler Screen Access Panel beneath center of machine) and set aside. Lower access panel.



Spring Clips (2) - Access Panel
(Located on the Hydraulic Oil
Cooler Screen Access Panel
beneath center of machine)
-Typical View

SECTION 8 – MAINTENANCE AND STORAGE



- Remove the two (2) additional Spring Clips (located on the bottom of the screen) and set aside.

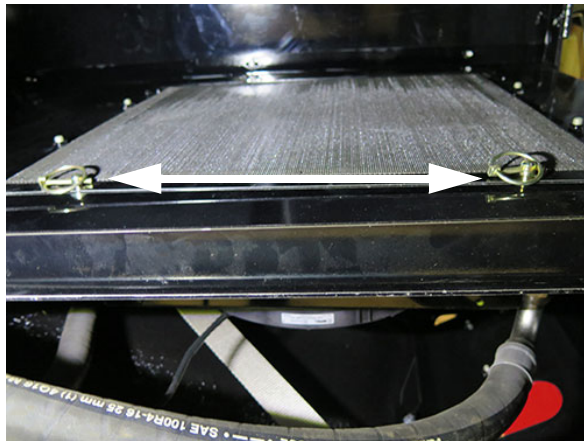

Spring Clips (2) - Screen
(Located on the bottom of the
Hydraulic Oil Cooler Screen)
-Typical View

- Remove the Hydraulic Oil Cooler Screen and clean as necessary.

NOTE: Use compressed air to dislodge large dirt and debris. Water from a pressurized hose may also be used or if necessary, the screen may be soaked with soapy water and scrubbed gently with a brush.

- Reverse steps to reinstall the Hydraulic Oil Cooler Screen.

Engine Oil Filter

The Engine Oil Filter (located on right-hand side of engine through access opening) should be replaced every 500 hours of operation or whenever the oil is changed, whichever occurs first.

Refer to the engine manufacturer's operation manual for further information.

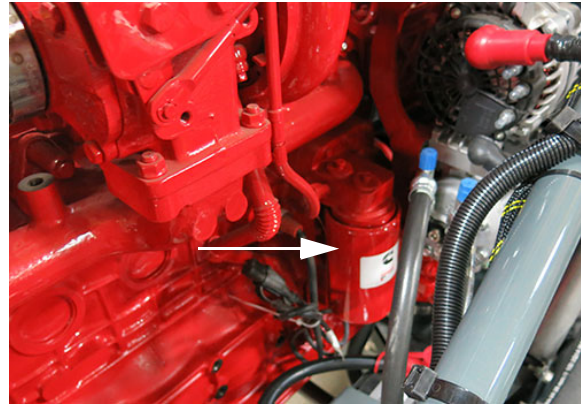

Engine Oil Filter
(Located on right-hand side of
engine through access opening)
-Typical View

Fuel Filters

Primary Fuel Filter (Water Separator)

The Primary Fuel Filter (located on left-hand side of engine through access opening) should be drained of water and other deposits daily. Replace the filter every 500 hours of operation or yearly, whichever occurs first.

Secondary Fuel Filter

The Secondary Fuel Filter (located on left-hand side of engine through access opening) should be replaced every 500 hours of operation or yearly, whichever occurs first.

Refer to the engine manufacturer's operation manual for further information.

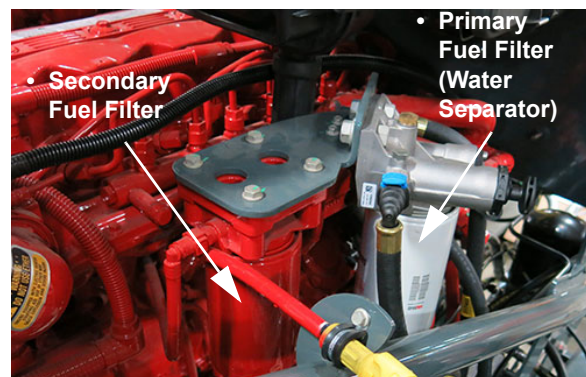

Primary and Secondary Fuel Filters
(Located on left-hand side of
engine through access opening)
-Typical View

NOTE: Cummins® recommends specific high performance fuel filters, which will aid in achieving optimum engine performance and efficiency. Refer to the engine manufacturer's operation manual for further information and specifications.

Diesel Exhaust Fluid (DEF) Supply Module Filter

(Final Tier 4 Engines)

The DEF Supply Module Filter (located beneath rear of machine) should be replaced every 4,500 hours of operation or every three (3) years, whichever occurs first.

Refer to the engine manufacturer's operation manual for further information.

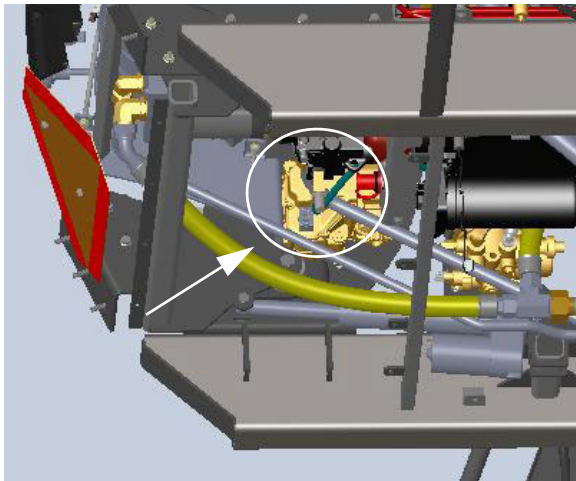

DEF Supply Module Filter
(Located beneath rear of machine)
-Typical View

** Rear underside of machine shown*

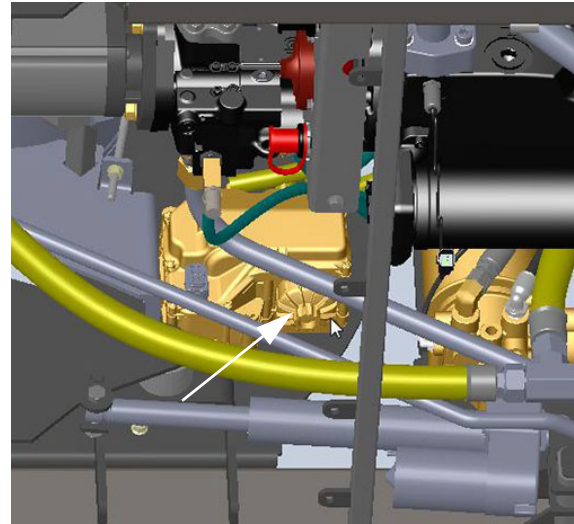

DEF Supply Module Filter
(Close up view)
-Typical View

Hydraulic Filters

(Refer to your Parts Manual for specific location and replacement part numbers)

Remove and replace hydraulic filters every 500 hours of operation or yearly, whichever occurs first.

- Return Filters (2)
- Pressure Filter
- Charge Pump Filter
- Tank Breather Cap

Replacing Hydraulic Filters

Return Filter 1

NOTE: Replace Return Filter when the filter indicator indicates that replacement is needed, becomes tripped, or after 500 hours of operation, whichever occurs first.

1. Remove the four (4) bolts on top of the Return Filter Housing (located on top of hydraulic oil reservoir - open hood to access) and set aside.

SECTION 8 – MAINTENANCE AND STORAGE



Return Filter Housing
(Located on top of hydraulic oil
reservoir - open hood to access)
-Typical View

2. Remove Return Filter Housing cover and set aside.
3. Remove and discard used Return Filter.



Return Filter 1
(Located inside filter housing)
-Typical View

4. Install new Return Filter.
5. Reinstall filter housing cover and bolts.

Return Filter 2

NOTE: Replace Return Filter when the filter indicator indicates that replacement is needed, becomes tripped, or after 500 hours of operation, whichever occurs first.

1. Rotate Return Filter (located beneath platform on right-hand side of machine) in the “counter-clockwise” position to loosen.



Return Filter 2
(Located beneath platform on
right-hand side of machine)
-Typical View

2. Remove and discard used Return Filter.
3. Install new Return Filter, rotating in the “clockwise” position to tighten.

Pressure Filter

1. Using a 15/16” wrench on the Pressure Filter Housing end bolt, turn “counter-clockwise” and remove filter housing.

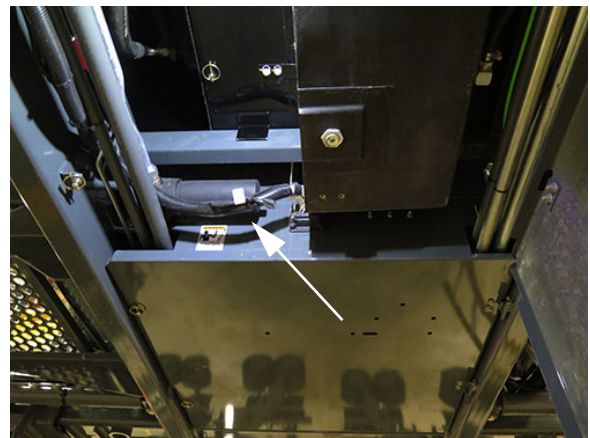

Pressure Filter
(Located beneath center of machine)
-Typical View

** Lower Tall Crop Package Belly Shield
to access - if equipped*

2. Remove and discard used Pressure Filter.

3. Install new Pressure Filter.
4. Reinstall Pressure Filter Housing and metal shield.

Charge Pump Filter

1. Ensure the engine is shut OFF.
2. Hold the Charge Pump Filter (located beneath rear of machine) in place and remove filter from housing using a 24mm wrench.



Charge Pump Filter
(Located beneath rear of machine)
-Typical View

3. Remove and discard used Charge Pump Filter.

NOTE: Inspect the plug and seal surfaces in the filter bracket. Replace any damaged components.

4. Lubricate the seal and o-ring with hydraulic fluid.
5. Insert plug into filter bracket.
6. Using a 24mm wrench to hold the plug in place, install new Charge Pump Filter.

NOTE: Hand-tighten filter until it makes contact with the o-ring, then tighten half a turn further.

7. Turn the engine ON.
8. Cycle the pump through normal machine operation and check for leaks.

Tank Breather Cap

1. Loosen Tank Breather Cap (located on top of hydraulic oil reservoir - open to access) by turning “counter-clockwise”.

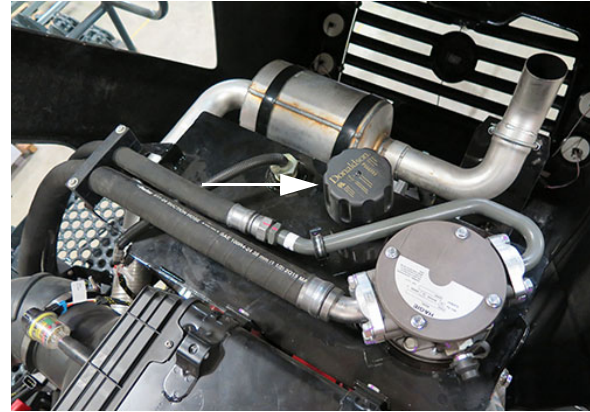

Tank Breather Cap
(Located on top of hydraulic oil reservoir - open hood to access)
-Typical View

2. Remove and discard used Tank Breather Cap.
3. Install new Tank Breather Cap and turn “clockwise” to tighten.

Cab Filters**RESPA® Cab Filter**

NOTE: Replace the RESPA Cab Filter every 1,000 of operation or when cab pressure drops below the minimum pressure threshold (when cab is sealed), whichever occurs first.

Replacing the RESPA Cab Filter:**⚠ CAUTION**

Do not clean or reuse filters. Failure to comply may create health hazards.

NOTICE

Replace filter in a clean and covered area to reduce operator and HVAC exposure to harmful particulates.

NOTICE

Ensure engine is turned OFF before servicing the RESPA Cab Filtration System.

NOTICE

When cleaning your machine, care should be taken to prevent high-pressure water or air from entering the RESPA Filtration System ejection slots. When replacing the slotted filter, do not point ejection slots at a solid surface in close proximity to the slots.

NOTE: Wear Personal Protective Equipment (PPE) when servicing the RESPA Cab Filtration System.

1. Turn engine OFF.
2. Inspect RESPA Cab Filtration System for damage.
3. Release the four (4) Filter Latches (located on the exterior filter housing).

NOTE: Note orientation of the ejection ports.



Filter Latches
-Typical View

4. Remove filter.

NOTE: When removing filter, place thumbs on exterior filter housing hardware for additional leverage.



Filter Removal
-Typical View

5. Place used filter in a sealed plastic bag and dispose.

NOTE: Dispose of filter according to local regulations.

6. Wipe off any loose debris around the filter housing using a clean cloth.

NOTE: DO NOT use compressed air to clean the filter housing.

7. Before installing the new filter, inspect the RESPA Cab Filtration System and replacement filter for proper operation.
8. Turn RESPA Filtration System ON, staying clear of the open end of the filter housing.
9. Ensure adequate airflow is blowing out of the empty filter housing.
10. Turn RESPA Filtration System OFF.
11. Install new filter.

NOTE: Ensure new filter ejection port orientation is correct and the filter end cap is properly seated on the filter housing (with the gills pointing downward to avoid water from entering in).

12. Re-latch the four (4) Filter Latches.

Refer to your Parts Manual for replacement part number.

Charcoal Filter

Remove and replace the Charcoal Filter at the first sign of chemical odor entering the cab area, or every 500 hours of operation at a minimum. Refer to your Parts Manual for replacement part number.

Accessing the Charcoal Filter

1. Loosen the top metal Flange Clamp (located near the top of the RESPA filtration unit).



Flange Clamp - Top
(Located near the top of
the RESPA filtration unit)
-Typical View

2. Separate the RESPA filter housing from the vent tube.
3. Remove the four (4) Mounting Bolts (two located on each side of access panel on the right-hand side of cab) and set aside.

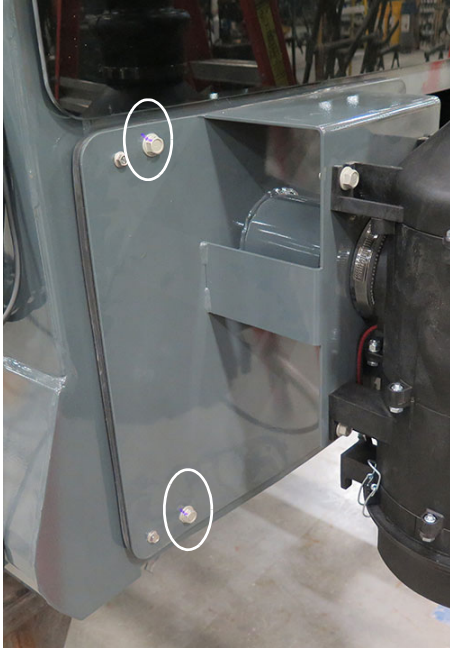

Mounting Bolts (4)
(Two located on each side of access panel on the right-hand side of cab)
-Typical View

4. Carefully lower access panel/filter assembly to the ground.
5. With the access panel removed, loosen and remove the Security Screw (located along the inside of filter compartment) and set aside.



Security Screw
(Located along the inside of filter compartment)
-Typical View

6. Remove the Filter Bracket (located along the right-hand side of charcoal filter) and set aside.

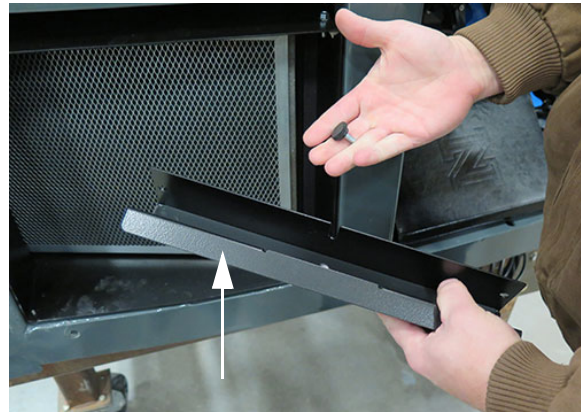

Filter Bracket
(Located along the right-hand side of charcoal filter)
-Typical View

7. Remove Charcoal Filter.



Charcoal Filter
-Typical View

8. Replace Charcoal Filter and reverse steps to reinstall.

Recirculation Filter

A Recirculation Filter is located along the right-hand side of compartment (accessible after the Charcoal Filter has been removed). Remove the Recirculation Filter and clean with soap and warm water (wring out gently) anytime that the Charcoal Filter is replaced.

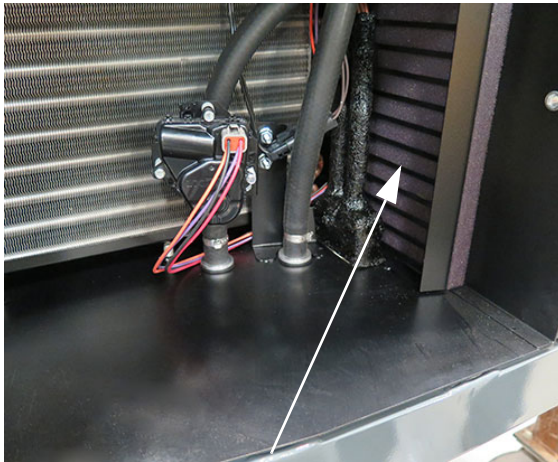

Recirculation Filter
(Located along the right-hand side of compartment)
-Typical View

SERVICE - LUBRICATION

NOTICE

Failure to properly lubricate pivot and friction points may result in unnecessary wear and damage.

NOTICE

SD Polyurea grease (complying with NLGI, EP, and ISO 220 specifications) recommended.

Legs and Steering

Tie Rod Ball

(Front Legs)

- Lubricate every 25 hours of operation, or as needed.

*NOTE: If your machine is equipped with AWS, the steering cylinders on the rear legs will also have grease zerks in the tie rod ends that require lubrication.**



Tie Rod Ball Grease Zerk
(Located on the front legs*)
-Typical View

SECTION 8 – MAINTENANCE AND STORAGE



Tower Bearing

(Front and Rear Legs)

- Lubricate daily, or as needed.

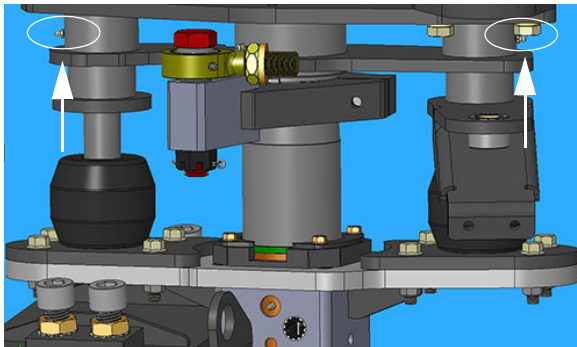

Tower Bearing Grease Zerks
(Located on the front and rear legs)
-Typical View

Leg Bearings

- Lubricate daily, or as needed.

The leg assemblies on your machine are constructed with upper and lower nylon bearings for suspension telescoping between the inner and outer leg weldments. These bearings must be lubricated to avoid bearing failure and ensure optimal ride quality. Grease zerks are located on the sides of the leg assemblies - one on the upper bearing, and two on the lower bearing.

NOTE: If the crop is mature enough or plant population is high enough, more frequent leg bearing grease application may be required to ensure proper lubrication and optimal performance.

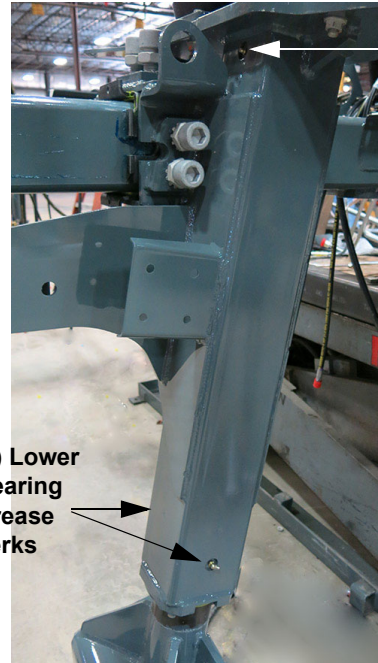

- (1) Upper Bearing Grease Zerk
- (2) Lower Bearing Grease Zerks

Leg Bearing Grease Zerks
-Typical View

Tread Adjust Bearing Slide Path

NOTICE

Failure to inspect and lubricate the tread adjust bearing slide path may cause one of the legs to “hang up” while the other is still sliding during adjustment. Failure to comply may result in machine damage.

- Inspect and clean the Tread Adjust Bearing Slide Path often (all four sides on each leg). Lubricate generously as needed.



Tread Adjust Bearing Slide Path (4)
(Located on each leg)
-Typical View

NOTE: During late season crop applications, the grease may possibly be wiped away due to the passing of crop leaves. More frequent grease application may be required to ensure proper lubrication and optimal performance.

Ladder Pivot Tube

Lubricate the grease zerk (located on the back side of the Ladder Pivot Tube) every 50 hours of operation, or as required.

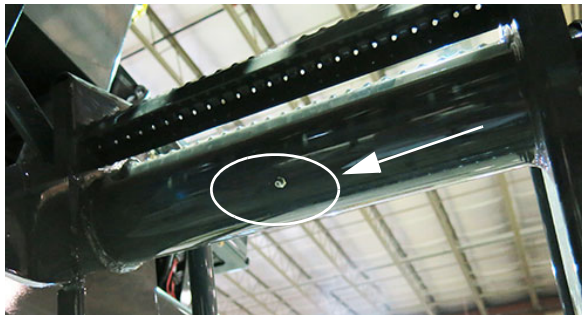

Ladder Pivot Tube
-Typical View

Detasseler Tool Bar

Quad Puller Heads

- Lubricate each Quad Puller Head grease zerk (4 - two each side) twice per day (morning and noon suggested).



Quad Puller Head
-Typical View

Outrigger Fold (Left and Right)

- Lubricate each left and right Outrigger Fold grease zerk (2) a minimum of every 50 hours of operation, or as needed.

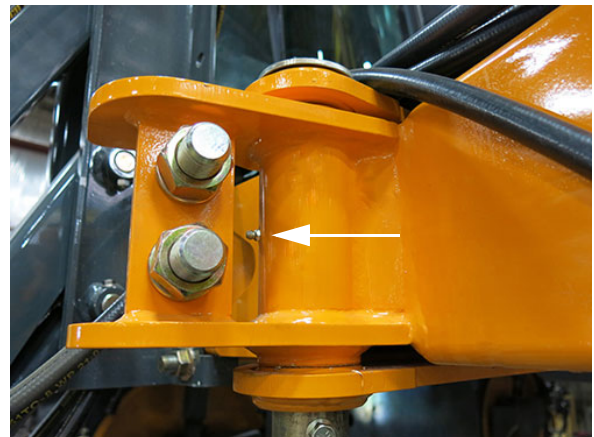

Outrigger Fold
-Typical View

Lift Arm Assemblies

- Lubricate each Lift Arm Assembly grease zerk (6) a minimum of every 50 hours of operation, or as needed.

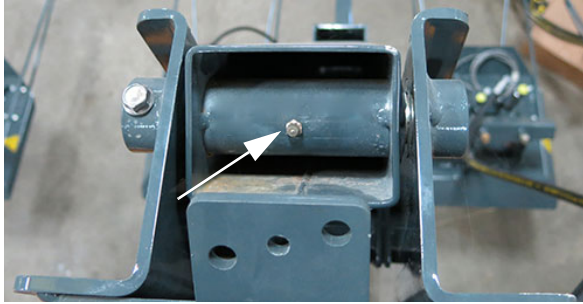

Lift Arm Assembly - Top
-Typical View



Lift Arm Assembly - Inner Arm
-Typical View

NOTE: An additional grease zerker is located inside of the lower lift arm frame.



Lift Arm Assembly - Mid
-Typical View

SERVICE - ENGINE DRIVE BELT

Removal

- Insert a 1/2" square ratchet drive into the belt tensioner. See following illustration.

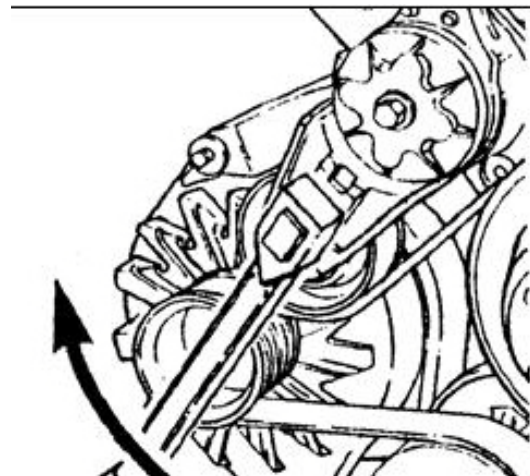

-Typical View

- Lift UP and remove Engine Drive Belt.

Inspection

- Visually inspect the Engine Drive Belt daily.

- Check the belt for intersecting cracks. See following illustration.

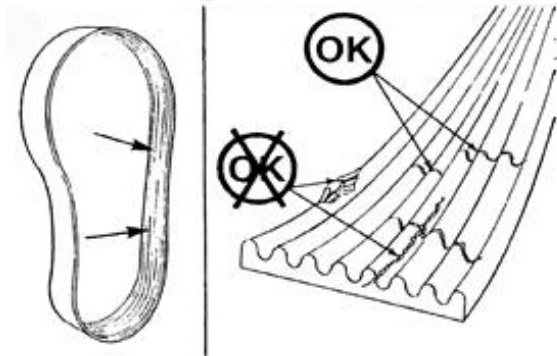

-Typical View

NOTE: Transverse cracks (across the belt width) are acceptable. Longitudinal cracks (direction of the belt length) that intersect with transverse cracks are not acceptable.

- Replace the Engine Drive Belt if it is frayed or has material missing.

SERVICE - BOLT TORQUE

NOTICE

Check lug nut torque immediately after receiving the machine and every 50 hours of operation thereafter.

Lug Nuts

NOTE: If you do not have the proper equipment to mount a tire, contact a local qualified tire service center.

The tire should be mounted on the rim (as shown in the following illustration) for optimal traction and tread cleaning action.



To Install Wheel/Tire Assembly onto the Wheel Hub

1. Ensure threads are thoroughly cleaned of rust and dirt.

NOTE: Ensure threads are properly lubricated.

2. Align the wheel bolt holes with the wheel hub studs.
3. Mount wheel on the hub.
4. Install 3/4" Spacer Ring around the wheel hub.

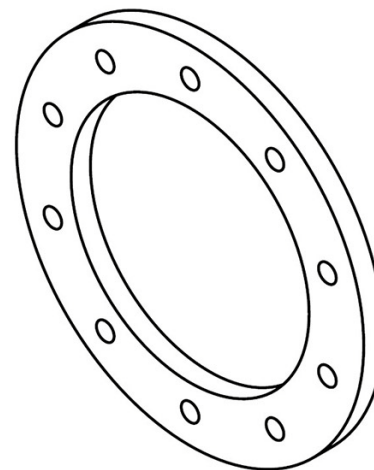

3/4" Spacer Ring
-Typical View

5. Install lug nuts to the wheel bolts.



Lug Nut Installation
-Typical View

6. Start all of the lug nuts and tighten until snug.
7. Following the torque sequence (as shown the following illustration), turn each lug nut to a torque value of 120 dry ft.-lbs.

NOTE: Use slow, even pressure on the torque wrench. Quick or jerky movements can cause inaccurate values.



Torque Sequence

8. Repeat the same sequence to 185 ft.-lbs.

NOTE: If the wheel turns during lug nut torquing, lower machine to the ground - just enough for the tire to touch and prevent rotation. Or, more preferably, place a suitable wedge between the tire and the ground. Lower the machine and resume operation. Recheck torque after 30 minutes of operation.

9. When torquing is complete, lubricate exposed threads with anti-seize compound.

Tread Adjust Bearing Bolt Torque

NOTE: With the engine turned OFF, visually inspect the Tread Adjust Bearing Bolts on both the top and side tread adjust bearing plates daily. Check the torque every 100 hours of operation.

NOTICE

Never operate machine with loose or missing tread plates. To visually inspect for loose tread plates, slowly rock the machine forward and backwards while observing the legs for movement. If plates become loose, the leg will rock as the machine starts to move.

1. Loosen the Jam Nut on each Tread Adjust Bearing Bolt.

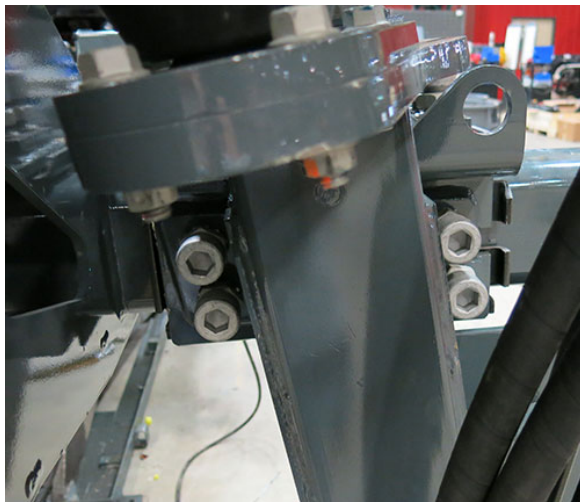
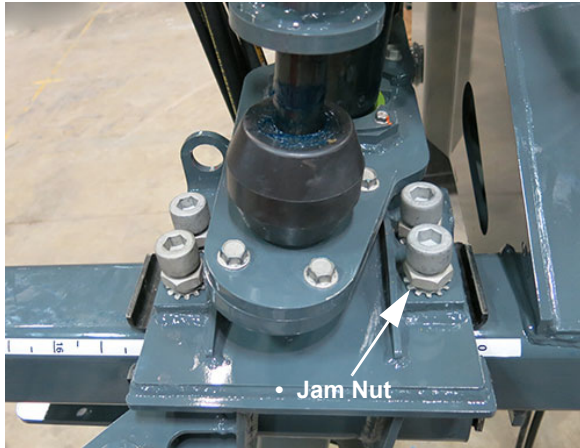

Tread Adjust Bearing Bolts - Top/Side
(Located on each leg)
-Typical View

2. **(a) Hydraulic Tread Adjust Machines** - Using an “X” pattern (as shown in the following photo), torque each Tread Adjust Bearing Bolt to 65 ft.-lbs.
(b) Mechanical Tread Adjust Machines - Using an “X” pattern (as shown in the following photo), torque each Tread Adjust Bearing Bolt to 100-ft.-lbs.



“X” Pattern
-Typical View

3. Repeat pattern 3 to 4 times until the last sequence shows no movement of the bolts to achieve desired torque.
4. Re-torque each Jam Nut to 200 ft.-lbs.

NOTICE

Even pressure of the tread adjust bearing plate is required for proper operation.

- **Figure A** - shows correct position of the tread adjust bearing plates and bolts, as well as the outer leg.
- **Figure B** - shows the plates when there is not even torque on each of the tread adjust bearing bolts.
- **Figure C** - shows a situation in which there is not enough torque on the tread adjust bearing bolts.

NOTE: Figures B and C will cause tread adjust to operate incorrectly, or not at all.

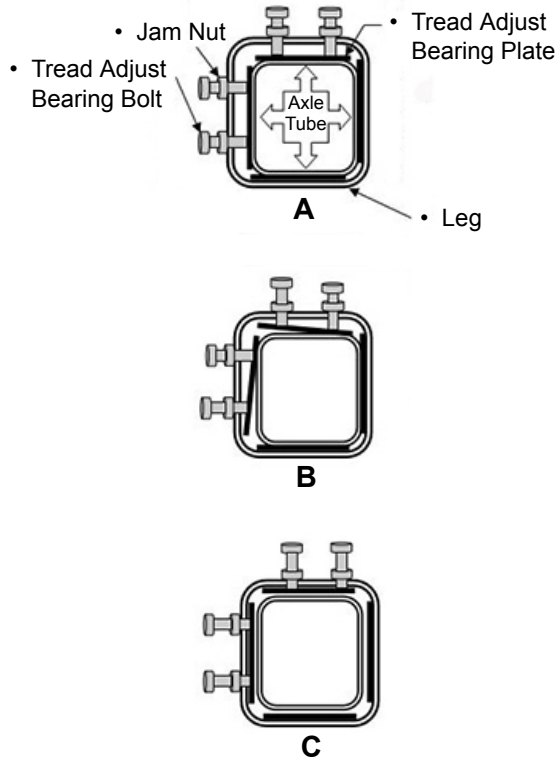

To Phase the Steering Cylinders

NOTICE

Disconnect cylinders from legs before aligning the wheels. Separating the hydraulic components (cylinders) from the mechanical components (position of wheels) is a critical step to improve the toe-in procedure. Ensure all cylinders are reinstalled after procedure is complete.

1. Start the machine.
2. Turn steering wheel to the right or left.
3. When the wheels stop turning, continue to turn the steering wheel 3 to 4 full revolutions (this will put the cylinders back in phase with each other).

Step 2 - Set Toe-In

Front Wheels

- .25" (.6 cm) Toe-In per side/0.5" (1.3 cm) total Toe-In

Rear Wheels

- 0" (0 cm) Toe-In/Out

To Set Toe-In

1. Deflate the air bags.

NOTE: Refer to "Air Suspension Exhaust" provided in the Miscellaneous Section elsewhere in this manual for further information.

2. Measure the distance from the ground to center of wheel hub.

NOTE: All four wheel hubs should measure the same distance.

3. Mark this distance on the inner edge of the wheel rim (front and back of each rim - 8 marks total).

NOTE: All measurements will be taken from these markings.

4. Visually align the tires from front to rear.

SERVICE - TOE-IN

Step 1 - Phase Steering Cylinders

The steering cylinders must be phased before any mechanical adjustments can be made (cylinder stroke = 8.8"/22.4 cm). When the cylinders are re-phased, each cylinder should reach mid-stroke (4.4"/11.2 cm). Once both cylinders are at 4.4"/11.2 cm, Toe-In can be set.

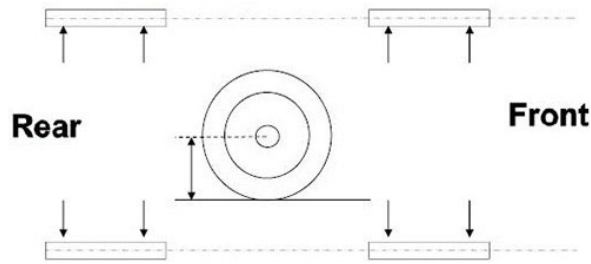

Front Wheels

5. Measure the width between the front wheels (front W1, rear W2) at the wheel hub center line and record measurements.
6. Adjust the wheels until the front and rear measurements are equal ($W1=W2$).
7. Measure diagonally (D1 and D2) and record the measurements.
8. Adjust the wheels until the measurements are equal.

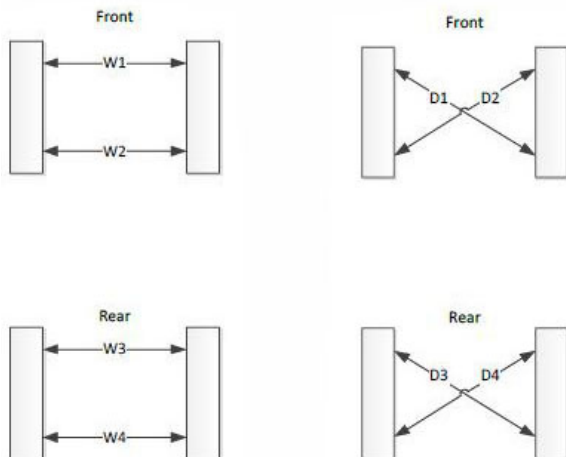

9. Continue to cycle between Steps 5-6 and 7-8 until the width measurements match and the diagonal measurements match. Then and only then are the wheels parallel to each other and the frame.

NOTE: To achieve this, both conditions must be met.

NOTE: The front steering cylinders must both be centered before proceeding!

10. Set both cylinders to center by measuring 7.64" (19.4 cm). The position sensors should both read 4.4" (11.2 cm) when the

cylinders are centered and in phase (10.A).

NOTE: This is not required for All-Wheel Steer (AWS) machines, as the cylinder position sensors can be used to center the cylinders.

- The cylinder sensors must be calibrated for this position to be accurate.
- If the cylinders do not center at this measurement, they are not in phase. To re-phase the cylinders, turn the steering wheel so that one cylinder is fully retracted and the other is fully extended. Turn the steering wheel at least one full turn past this point. Re-center the cylinders. If the measurements still do not match, repeat the cylinder air bleed procedure.

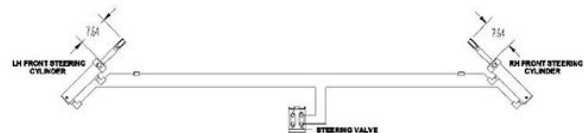

11. With the cylinders centered, adjust the tie-rods (located on the cylinder rods) until they line up with the bolt-down hole (located on the lower air bag plate).
12. Turn the tie-rod one more full turn to achieve desired amount of toe-in.
 - When the rod ends are turned the final turn (to establish the desired amount of toe-in), the rod ends turn in opposite directions to get each wheel in toe.
 - If the amount of threads showing on the left and right-hand rod ends differ by more than four (4) threads, repeat previous Steps 1-12. If the difference remains, there may be a tolerance issue in the leg assembly.
13. Pry wheel in to allow rod end securing bolt to be inserted.
14. Insert bolt and torque main bolt and cylinder jam nut to proper specification.

SECTION 8 – MAINTENANCE AND STORAGE



Rear Wheels

NOTE: Rear wheels should be set to 0.0” (0.0 cm) toe in/out.

15. Repeat previous Steps 1-9.
16. **(Non-AWS Machines)** - Set tie rod assembly to match up with the bolt-down hole (located on the lower air bag plate). Insert bolt and secure to the proper torque specification (refer to “Torque Values” provided in the *Introduction Section* elsewhere in this manual for further information).
17. **(AWS Machines)** - Repeat Step 10, centering the rear cylinders at 4.4” (11.2 cm). Insert bolt and torque main bolt and cylinder jam nut to proper specification.

NOTE: The cylinder sensors must be calibrated for this position to be accurate.

- The machine should be driven and toe (front and rear) rechecked.
- Front steering cylinders must be in phase when toe setting is checked.
- Failure to hold toe setting could indicate the presence of air in the cylinders.
- Repeat the cylinder bleeding procedure, if necessary.

Further Information

Contact your local John Deere dealer if additional assistance is needed.

SERVICE - AIR SPRINGS

(Air Bags)

Air Ride Adjustment



NOTE: Visually inspect the height of each air bag daily. Measure height of each air bag (using a tape measure) every 50 hours of operation. Adjust as necessary.

1. Park the machine on level ground with outriggers in the completely UNFOLDED position.
2. Adjust the air pressure in each Air Bag until the distance between the bottom of the Steering Plate (A) and the top of the Bumper Pad Strike Plate (B) is between 7-7.5” (17.8-19.1 cm). See following illustration.

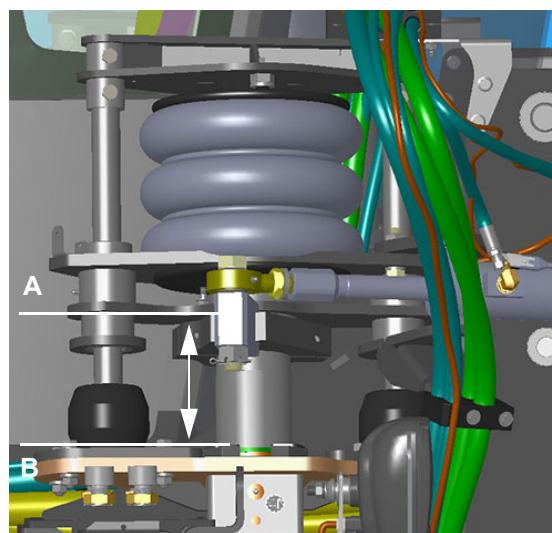

Air Bag Assembly
(Located on each leg)
-Typical View

3. With a clear path on level ground, drive the machine forward 100 yards (91m), cycling the steering back and forth, and shifting machine weight from side to side.
4. Stop on level ground and re-measure. Adjust as necessary.
5. Repeat procedure until desired measurement is achieved.

The amount of pressure in the Air Bags will depend on the options available on the machine. Typically, pressure should be approximately 42 psi/2.9 bar (front) and 24 psi/1.7 bar (rear). The pressure should be enough that the tie rods and steering cylinders are level.

Wiper Blade

NOTICE

Use a sturdy stationary ladder to safely access the wiper blade.

Do not allow the Wiper Blade to run on a dry windshield, as this will shorten the life of the blade and/or cause scratching on the windshield.

NOTE: Replace the windshield wiper blade (39"/99 cm) as necessary.

The Windshield Washer Fluid Spray Nozzle is adjustable. The fluid spray pattern should be inspected at the beginning of each season, and adjusted as necessary.



Windshield Washer Fluid Spray Nozzle
(Located near top of exterior cab)
-Typical View

Washing the Machine

Thoroughly wash the machine as often as possible and apply paint to any place where the paint is faded or missing.

For replacement decals or touch-up paint recommendations, contact your local John Deere dealer.



SERVICE INTERVALS

Service Point	Initial	Daily/ Before Each Use	As Required	50 Hrs.	100 Hrs.	250 Hrs. **	500 Hrs. **	1000 Hrs.
Check Lug Nut Torque (Break-in)	X							
Check Engine Oil Level		X						
Check Radiator Coolant Level		X						
Check Radiator Grille Screen		X						
Check Hydraulic Oil Cooler Screen		X						
Check Engine Drive Belt		X						
Check Hydraulic Reservoir Level		X						
Check Batteries		X						
Check for Leaks Around the Machine		X						
Check Windshield Washer Fluid Level		X						
Wash Machine		X						
Check and Drain Primary Fuel Filter (Water Separator)		X						
Check Air Bags (Visually)		X						
Check Tread Adjust Bearing Bolts (Visually)		X						
Check Engine Air Intake Piping		X						
Check Quad Puller Tire Pressure		X						
Check/Tighten Cutter Blade Retaining Bolts		X						
Lubricate Quad Puller Head Grease Zerks		X						
Check Aftertreatment DEF Tank Level (Final Tier 4 Engines)		X						

**SECTION 8 –
MAINTENANCE AND STORAGE**



Service Point	Initial	Daily/ Before Each Use	As Required	50 Hrs.	100 Hrs.	250 Hrs. **	500 Hrs. **	1000 Hrs.
Check Aftertreatment DEF Exhaust Piping (Final Tier 4 Engines)		X						
Lubricate Leg Grease Zerks			X					
Replace Windshield Wiper Blade			X					
Fill Windshield Washer Fluid Reservoir			X					
Clean Radiator Grille Screen			X					
Clean Hydraulic Oil Cooler Screen			X					
Change Engine Drive Belt			X					
Charge A/C Compressor *			X					
Change Air Intake Filter (Filter Minder)			X					
Change Tread Adjustment Bearing Torque			X					
Change Batteries			X					
Change or Replace Fuses and Breakers			X					
Replace Charcoal Cab Filter			X					
Clean Cab Recirculation Filter			X					
Check Tire Pressure			X					
Lubricate Hydraulic Tread Adjust Bearing Slide Path			X					
Adjust Air Bag Suspension Height			X					
Inspect/Clean/Lubricate Tread Adjust Bearing Slide Path			X					
Check Air Bags (Measure)				X				
Lubricate Air Bag Collar Grease Zerk				X				
Check Lug Nut Torque				X				
Lubricate Ladder Pivot Tube Grease Zerk				X				



SECTION 8 – MAINTENANCE AND STORAGE

Service Point	Initial	Daily/ Before Each Use	As Required	50 Hrs.	100 Hrs.	250 Hrs. **	500 Hrs. **	1000 Hrs.
Change Wheel Hub Oil (Break-in)				X				
Lubricate Outrigger Fold Grease Zerks				X				
Lubricate Lift Arm Assembly Grease Zerks				X				
Check Wheel Hub Oil Level					X			
Clean Batteries					X			
Check Tread Adjust Bearing Bolt Torque					X			
Change Wheel Hub Oil						X		
Change Engine Oil							X	
Change Engine Oil Filter							X	
Change Primary Fuel Filter (Water Separator)							X	
Change Secondary Fuel Filter							X	
Change Hydraulic Return Filters (2)							X	
Change Hydraulic Pressure Filter							X	
Change Hydraulic Charge Pump Filter							X	
Change Hydraulic Tank Breather Cap							X	
Check Radiator Coolant Concentration							X	
Change Hydraulic Reservoir Oil								X
Replace RESPA® Cab Filter								X
Change Radiator Coolant								X
Exhaust Brake Service (contact engine manufacturer)								X

* Use proper equipment.

** 250-500 hours or yearly, whichever occurs first.

NOTE: Final Tier 4 Engines - Replace Aftertreatment Diesel Exhaust Fluid (DEF) Supply Module Filter every 4,500 hours of operation. Refer to the engine manufacturer's operation manual for further information.

STORAGE

Preparing For Storage

1. Perform daily level checks, lubrication, and bolt/linkage inspections, as required in this manual.
2. Every other season, drain coolant from engine and radiator. Probe the drain holes during drainage to ensure they are not clogged by sludge, scale, or other deposits. Fill cooling system to the top with a 50/50 water/antifreeze mixture. Run the engine to operating temperature and recheck level.
3. Add fuel stabilizer to fuel and fill the tank.
4. Run engine until it reaches operating temperature, then drain the engine oil. Refill with fresh oil of recommended weight and install a new lubricating oil filter element.
5. With the engine at normal operating temperature, cycle all hydraulic functions, including the steering.
6. Release tension on all belts.
7. Use plastic bags and water-resistant adhesive tape to seal the air intake opening, all exhaust manifold openings, engine oil fill cap, hydraulic oil tank breather cap, and fuel tank cap.
8. Final Tier 4 Engines - Plug the Diesel Exhaust Fluid (DEF) tank venting to seal tank exposure against environmental elements.
9. Turn the Battery Disconnect Switch OFF.
10. Disconnect and remove batteries. Completely clean and charge the batteries. Coat the terminals with dielectric grease and store batteries in a cool place (above freezing).
11. Thoroughly wash the machine and attachment. Touch up any painted surfaces that are scratched or chipped.

NOTE: For paint touch-up recommendations, contact your local John Deere dealer.

12. Replace worn or missing decals. Refer to “Safety Decals” in the *Safety and Precautions Section* for proper location of warning decals and corresponding part number.

NOTE: For decal replacement, contact your local John Deere dealer.

13. Apply multi-purpose grease to coat exposed hydraulic cylinder rods.
14. If the machine must be stored outside, cover with a waterproof cover.

Removing From Storage

NOTICE

Protective compounds such as grease can harden under exposure to weather conditions. Be sure to remove any dried grease and reapply new, if necessary.

1. Inspect the condition of and test the air pressure of all tires.
2. Carefully unseal all openings that were previously sealed in the “Preparing for Storage” process.
3. Clean and reinstall batteries. Be sure to attach battery cables to proper terminals.
4. Tighten all belts. Inspect and replace any worn belts.
5. Check engine oil, hydraulic oil, and engine coolant levels, and add if necessary.

NOTE: A mixture of 50/50 water/antifreeze will cool adequately in the summer, as well as protect in winter.

6. Thoroughly clean the machine and attachment.
7. Perform all recommended services as instructed elsewhere in this section.
8. Manually cycle tool bar hydraulics two or three times to adequately lubricate components.
9. Reset date and time on Machine Display.
10. For starting instructions, refer to “Engine - Starting” provided in the *Engine and Drive Systems Section* elsewhere in this manual.



SECTION 9 – MISCELLANEOUS

TRANSPORTING

When driving the machine on a public roadway or elsewhere, be aware of any situation where the detasseler will be passing under an object with a clearance lower than the transporting height of the machine. Refer to “Specifications” provided in the *Introduction Section* elsewhere in this manual for further information.

! WARNING

Stopping the detasseler on trailer ramps may cause the machine to tip over.

! WARNING

When transporting the machine, observe the following to avoid serious injury or death:

- Check for adequate clearance before driving under any overhead obstructions.
- Contact with power lines may result in serious injury or death.

! CAUTION

Avoid collisions. Before transporting machine on a public roadway, check and follow local regulations regarding size limits, the use of lights, flags, signs, pilot vehicles, and other requirements for transporting loads using trailer.

! CAUTION

Ensure the detasseler outriggers are in the fully folded position before transporting the machine. Failure to comply may result in injury or property damage.

Folding the Outriggers

NOTICE

Stagger detasseling heads before folding the outriggers. Failure to comply will result in property damage.

Before folding the outriggers, the detasseling heads must be staggered in height. Damage will occur if detasseling heads are all the same height when the outriggers are folded.

To Stagger the Detasseling Heads

1. Press the Attachment Button (located on the Machine Display Main Menu).



Attachment Button
(Located on the Machine
Display Main Menu)

SECTION 9 – MISCELLANEOUS



2. PREP TO FOLD - Press the Prep Button (located on the Machine Display “DTB Lifts/Motors” screen OR the “DTB Depth Command” screen).

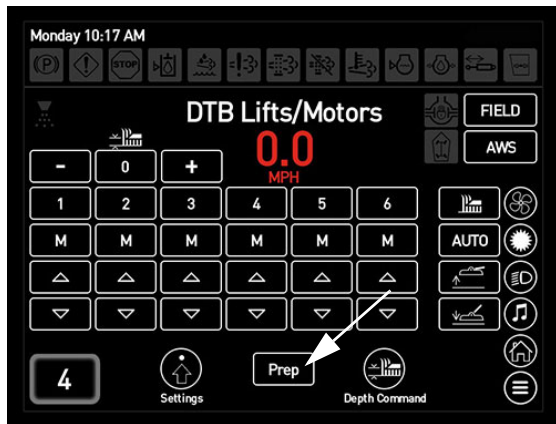

Prep Button
(Located on the Machine Display
DTB Lifts/Motors Screen or
DTB Depth Command Screen)

3. Press BOTH left and right-hand Level Switches (located on the Hydrostatic Drive Control Handle) either UP or DOWN simultaneously. The tool bar will then adjust the lifts and the depth command actuators will position to allow folding.

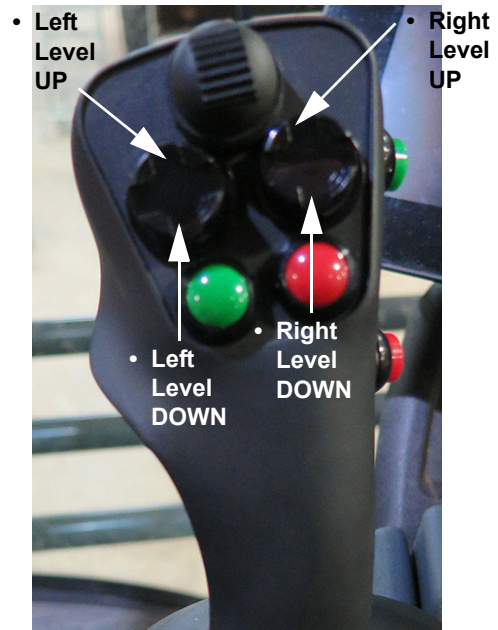

Level Switches - Left/Right
(Located on the Hydrostatic
Drive Control Handle)
-Typical View

NOTE: Once the tool bar is prepped to fold, a “DTB Prep to Fold Complete” message will appear on the display.



Staggered Detasseling Heads
-Typical View

Alternatively, if manual detasseling head staggering is desired, perform Steps 4-6 through the Machine Display. Refer to “Tasselrol™ XL/LS System 12” provided elsewhere in this manual for further information.

4. Lower the two center detasseling heads all the way DOWN.

5. Raise all the detasseling heads on one side to approximately half of the fully raised height.
6. Raise the detasseling heads on the opposite side to the fully raised height.

To Fold the Outriggers

- Slowly fold the outriggers in, making adjustments (as necessary) to the height of the detasseling heads.
Refer to “Fold Procedure - Detasseler Tool Bar” elsewhere in this manual for further information.

NOTICE

Do not attempt to make any adjustments to the detasseling heads after the outriggers are folded. Failure to comply may cause the stalk guides or depth command sensor bars to entangle, resulting in equipment damage.

Driving the Machine on a Public Roadway

1. Ensure the detasseler outriggers are in the fully retracted (folded) position when driving or transporting the machine.
2. Transport machine at narrowest tread adjust setting only.
3. Use the flashing hazard/warning lights, day or night to warn other drivers, unless prohibited by law.
4. Know and obey all state laws for driving agricultural equipment on a public roadway.
5. Adjust machine speed to suit the conditions.
6. Slow down and use turn signals before turning.
7. Pull over to the side of the road before stopping.
8. Keep a proper lookout and maintain control of the machine.
9. Do not drive under trees, bridges, wires, or other obstructions unless there is adequate clearance.
10. Use extra care before entering or exiting a public roadway.

11. Ensure the SMV (Slow Moving Vehicle) and SIS (Speed Indicator Symbol) emblems are properly displayed to warn other drivers, unless prohibited by law.

Transporting Machine Using Trailer

Loading

WARNING

Keep all persons away from trailer when loading or unloading the machine. Failure to comply may result in serious injury or death.

NOTICE

Read and understand the trailer manufacturer’s operation manual. Hitch the trailer to the pulling vehicle according to their recommendations.

NOTICE

The loaded height and width of the trailer must conform to state law in which it is being used. Do not exceed the trailer manufacturer’s recommendations on loaded weight.

1. Pull the trailer to flat ground.
2. Apply the pulling vehicle’s parking brake and turn the engine OFF.
3. Use tire chocks to keep the trailer from moving.
4. Ensure the detasseler outriggers are in the fully retracted (folded) position.
5. Lower the trailer ramps and set the ramp spacing for the machine’s tread width setting.

6. Have an attendant help guide you onto the trailer.
7. Allow enough room between the machine and the pulling vehicle for turning.
8. Secure the machine onto the trailer using the recommended securement restraints (see trailer manufacturer's operation manual).
9. Cover or remove the SMV (Slow Moving Vehicle) and SIS (Speed Indicator Symbol) emblems when traveling over 30 mph (50 km/h).

Unloading

1. Pull the trailer to flat ground.
2. Apply the pulling vehicle's parking brake and turn the engine OFF.
3. Use tire chocks to keep the trailer from moving.
4. Lower the trailer ramps and set the ramp spacing for the machine's tread width setting.
5. Carefully release the securement restraints.
6. Have an attendant help guide you off of the trailer.
7. Uncover or replace the SMV and SIS emblems.

TOWING

IMPORTANT

To tow or pull the sprayer, the engine **MUST** be running and the hydraulic system **MUST** have correct hydraulic pressure or damage **WILL** occur to the brakes and wheel hubs. If engine is not running or proper hydraulic system pressure cannot be maintained, see your John Deere dealer.

The machine should only be towed with the engine running, correct hydraulic pressure, and the machine's parking brake disengaged. Only tow the machine a short distance and at a speed not exceeding 3 mph (5 km/h). Towing the machine more than 100 meters is not recommended.

IMPORTANT

- The following towing procedure is intended for short distance emergencies only. If long distance towing is necessary, transport disabled machine on a trailer.
- Before towing the machine, ensure towing apparatuses are in good condition and have sufficient mechanical strength for towing the machine.
- Keep the tow angle to a minimum of 30° or less from the straight-ahead direction.
- Maintain gradual and smooth machine movement when towing.
- An additional tow vehicle behind the machine is required when towing a disabled machine in order to provide sufficient control and braking.

NOTE: Machine is not equipped with an “emergency steering pump” power source. Therefore, manual user input of the steering wheel is required to steer the machine while towing.

Towing the Machine

1. Lower the front end cap (1A).
Refer to “Front End Access” elsewhere in this manual for further information.

⚠ CAUTION

Lower the front end cap as directed. Failure to comply may result in personal injury.



CAUTION
CRUSH HAZARD.
RISK OF INJURY DUE TO IMPROPER OPERATION. REFER TO OPERATOR’S MANUAL FOR INSTRUCTION.



2. Attach two (2) suitable chains or straps to the two provided tow hooks (2A).

NOTE: The machine will be pulled from these two chains/straps.

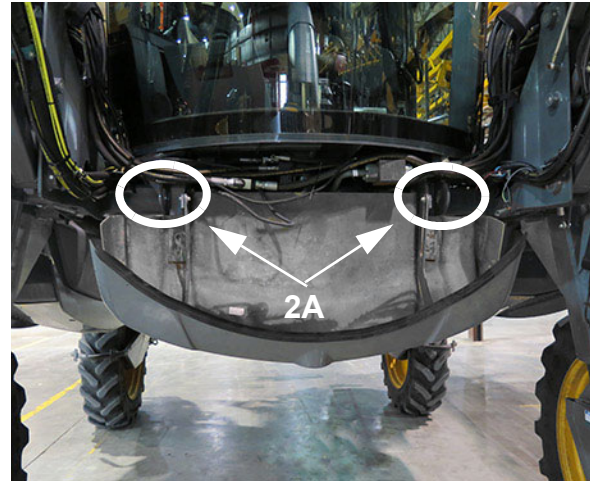

3. Attach two (2) suitable chains or straps to the rear axle tubes (as close to the mainframe as possible). **These chains/straps will be used to brake the machine once it is moving, as the machine will not be capable of stopping itself.**

NOTE: If the chains/straps contact other components while towing, those components should be removed or the chains/straps relocated prior to towing.

NOTE: A vehicle of comparable size and weight should be used to tow the machine and a larger vehicle capable of stopping the machine should be attached to the rear of machine for braking and stopping.

4. **If engine is able to run**, start the engine and disengage the parking brake.

NOTE: If ladder does not raise, the parking brake is not disengaged. Contact your John Deere dealer for towing assistance.

5. Pull the machine forward to the nearest safe location at a slow speed not exceeding 3 mph (5 km/h). **Engage the parking brake before removing the tow chains/straps.**

If engine is not able to run, contact your John Deere dealer for towing assistance.

LIFTING YOUR MACHINE

WARNING

Do not lift machine by more than one or two lifting points at the same time. Failure to comply will cause the machine to become unstable, resulting in serious injury or death.

WARNING

Use extreme caution when supporting machine by a lifting point. Failure to obtain proper location and lifting equipment may cause the machine to become unstable, resulting in serious injury or death.

NOTICE

Lift machine on hard level surface with properly rated equipment only.

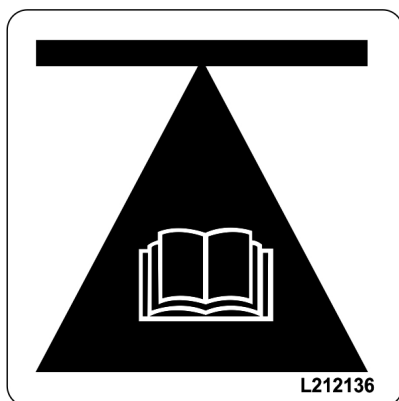

RISK OF INJURY DUE TO IMPROPER LIFTING.
DO NOT ATTEMPT TO LIFT MACHINE
WITHOUT JACKS PROPERLY SEATED IN THE
LIFTING POINT CONTAINMENT RINGS.

There are four (4) designated lifting points on the machine. These points are located on the frame near each leg and are equipped with containment rings for safe jack location.

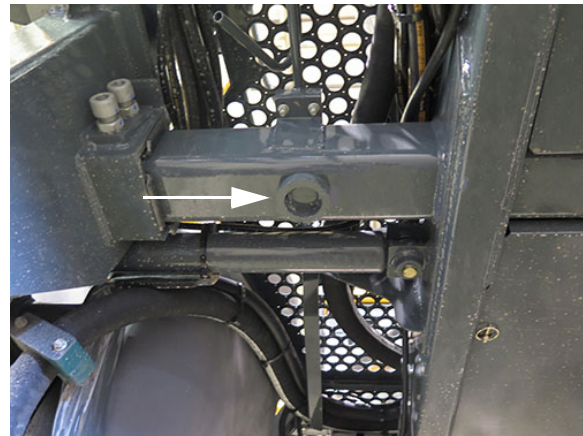

Lifting Point Containment Ring
(Located on the frame near each leg)
-Typical View

To Lift Machine (Bottle Jacks)

1. Shut the engine off.

NOTE: The parking brake will engage automatically when the engine is shut off.

2. Place wood blocks in front and rear of the tires not being lifted.
3. Align jack with Lifting Point Containment Ring.



Align Jack with Lifting
Point Containment Ring
-Typical View



Insert Jack Around Lifting
Point Containment Ring
-Typical View

4. Connect air supply to jack.
5. Tap air supply handle and slowly insert jack around Lifting Point Containment Ring.
6. Once jack is fully seated around the Lifting Point Containment Ring, continue to press and hold air supply handle until the machine reaches desired height.

⚠ WARNING

Ensure lock pins are fully inserted at base of jack. Do not rely on jack air supply to support a raised machine. Sudden loss of air pressure will cause the machine to become unstable, resulting in serious injury or death.

7. Install Lock Pins to the base of jack.



Lock Pin Installation
-Typical View

8. Reverse steps to lower machine.

AIR SUSPENSION EXHAUST

(Air Bags)



NOTE: Inspect air bags daily for leaks and/or cracking.

NOTE: Air Bags should be inflated between 6.5-7.5" (16.5-19 cm) when the tool bar is in the working (field) position.

To Inflate Air Bags

- Remove cap from Air Bag Valve Stem (located on top of each air bag) and set aside.
- Using an airline with locking air chuck, fill Air Bag to desired capacity.

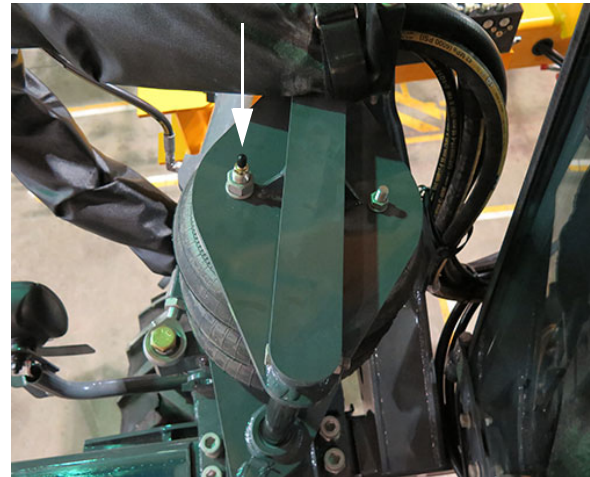

Air Bag Valve Stem
(Located on top of each air bag)
-Typical View

- Reinstall cap to Air Bag Valve Stem.

To Deflate Air Bags

- Remove cap from Air Bag Valve (located on top of each air bag) and set aside.
- Using a suitable device, press the center stem of valve inward to relieve pressure.

Air Ride Adjustment

Refer to "Service - Air Springs" provided in the *Maintenance and Storage Section* elsewhere in this manual for further information.

VISCOUS CLUTCH FAN

-If Equipped

NOTE: If your machine is equipped with the Variable Pitch Reversible Fan, refer to the Hydraulic Section elsewhere in this manual for further information.



WARNING

Improper operation, maintenance, or repair of this product can be dangerous and may result in serious injury or death.

- Always use Hagie-approved parts and components. Failure to comply will result in voiding the 1-year parts warranty.
- Do not operate or perform any service on this product until you have read and understand the operation and maintenance information. Contact your local John Deere dealer for any additional information that you may require.
- The person(s) servicing the product may be unfamiliar with many of the systems or components of the product. Use caution when performing service. Knowledge of the product and components are important before the removal or disassembly of any component.

NOTICE

The fan system reduces power and fuel consumption of the engine when full airflow is not required to keep the engine cool.

The automatically controlled Viscous Clutch Fan uses special fluid and valves to vary the speed of the fan with inputs from an Electronic Control Unit (ECU) based off of temperature readings from the cooling system, which provides precision fan control, increased cooling performance, improved fuel economy, and less noise. The fan is direct engine-mounted and consumes up to 30 hp (22 kw) at full speed.

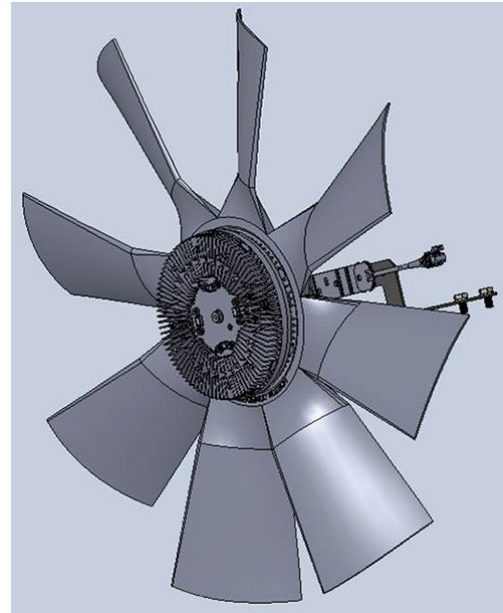

Viscous Clutch Fan
(Located near the rear of machine
- open hood to access)
-Typical View

Before Starting the Engine

1. Ensure all hoses and wires are adequately secured and routed away from the fan operating area.
2. Ensure all tools have been removed from the engine compartment, including the top side of the radiator and inside of the shroud before the fan guards are installed. Obstacles in the path of rotation can interfere with movement of the fan and can result in damage to the fan blades, fan hub, and radiator core.
3. Inspect the radiator shroud mounting bolts to ensure that the radiator and shroud are firmly secured and unable to move during operation of the machine.

Loose shroud bolts can allow the fan shroud to move into the path of the rotating blades and loose radiator mounting bolts can allow the radiator to flex in position, allowing the shroud to come into contact with the rotating fan blades.

4. Ensure all fan guards have been installed and firmly secured into place. The Reversible Fan creates an abundant amount of airflow in both cooling and cleaning mode operation. The result of this airflow is a strong vacuum effect that can suck in items that are located inside or around the engine compartment fan.
5. To ensure maximum efficiency, start with a clean cooling system free of debris, paying particular attention to the stacked cooler core(s).

Service and Maintenance

 **WARNING**

Ensure the Battery Disconnect Switch is OFF before performing any service on the fan. Failure to comply may result in engine turnover, serious injury, or death.

Under normal operating conditions, the Reversible Fan does not require scheduled maintenance (other than lubrication) and is built to provide thousands of hours of trouble-free service.

In moderate to extreme operating conditions, a visual inspection of moving parts is recommended from time to time to safeguard against fan blade damage, which could lead to equipment and/or other damage.

ELECTRIC HOOD

NOTICE

Do not operate machine with the hood open. Failure to comply may result in property damage.

The rear hood is equipped with an electric hood actuator, which allows the hood to be opened and closed by the touch of a switch.

To Open Hood

- Press and hold the Hood Actuator Switch (located near front of hood above the radiator screen) in the OPEN (Left) position.

NOTE: If the hood does not open upon activation, release the Hood Actuator Switch and try again.

- Release Hood Actuator Switch when hood has opened to desired position.



Hood Actuator Switch
(Located near front of hood
above the radiator screen)
-Typical View

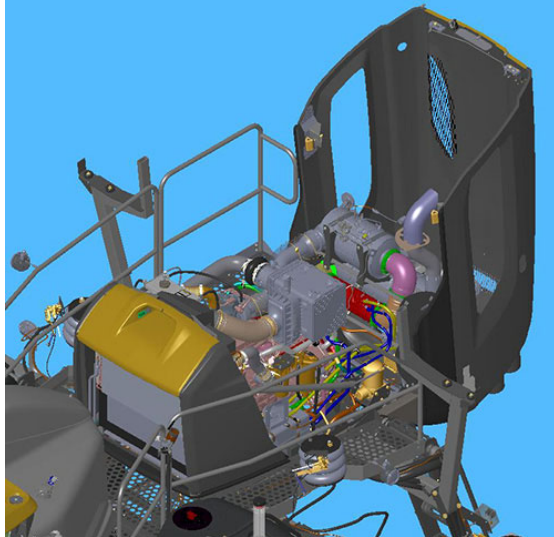

Rear Hood
(Open position shown)
-Typical View

To Close Hood

- Press and hold the Hood Actuator Switch in the CLOSE (Right) position until hood is fully retracted and comes to a complete stop.



Rear Hood
(Closed position shown)
-Typical View

**Powering the Hood Actuator
(when battery charge is depleted)**

Refer to “Engine - Starting” provided in the *Engine and Drive Systems Section* elsewhere in this manual for information on jump starting the machine.

FRONT END ACCESS

Your machine is featured with a fiberglass front end cap, which can be lowered to access items such as:

- Steering Valve
- Auto Steer Connection to Steering Valve
- Steering Angle Sensor Absolute (SASA) Sensor
- Drive Hose Connections
- Brake Hose Connection
- Pressure, Tank, and Excess Flow Connections (Auxiliary Functions)
- Horn/Electrical Connections
- Front Headlight Harness Connection

To Lower Front End Cap

⚠ CAUTION

Lower the front end cap as directed. Failure to comply may result in personal injury.

650504

CAUTION
CRUSH HAZARD.
RISK OF INJURY DUE TO IMPROPER
OPERATION. REFER TO OPERATOR'S
MANUAL FOR INSTRUCTION.

1. Using a 7/16” wrench, remove the two (2) mounting nuts/bolts (located beneath front end of machine) and set aside.



Mounting Nuts/Bolts (2)
(Located beneath front end of machine)
-Typical View

2. Standing behind the front end cap with one hand supporting the front of cap and the other hand near the rear center of cap (as shown in the following photo), push front end cap OUTWARD (toward front of machine) and lower.



-Typical View



Front End Cap
(Lowered position shown)
-Typical View

3. Reverse steps to raise front end cap to stored position, ensuring the mounting nuts/bolts are reinstalled.

TREAD ADJUSTMENT - MANUAL

-If Equipped

NOTE: Refer to the Hydraulic Systems Section elsewhere in this manual for information on adjusting Hydraulic Tread Width (if equipped).

Your machine may be equipped with Manual Tread Adjust to boost capability and perform applications for various field row widths and cropping stages with minimal crop damage.

Tread Range

- Minimum Tread Width = 120" (304.8 cm)*
- Maximum Tread Width = 160" (406.4 cm)*

* Depending on tire size.

To Adjust Tread Width

⚠ WARNING

Ensure the detasseler outriggers are fully retracted (folded) before adjusting manual tread width. Failure to comply may result in injury or death.

⚠ CAUTION

Ensure the machine is on level ground where there are no ditches or valleys to interfere when adjusting tread width.

NOTICE

Adjusting manual tread width requires use of specific tools and equipment. Contact your local John Deere dealer for assistance if you do not have the proper equipment to perform this procedure safely.

1. Ensure the detasseler outriggers are in the fully retracted (folded) position.
2. Park the machine on a hard level surface.
3. Shut the engine OFF.
4. Engage the parking brake.
5. Ensure the Tread Adjust Slide Path (located on each leg) has an adequately lubricated surface to slide along during adjustment.

NOTE: Refer to “Service - Lubrication” provided in the Maintenance and Storage Section elsewhere in this manual for further information.



Tread Adjust Slide Path
(Located on each leg)
-Typical View

6. Loosen the front and rear Tread Adjust Bearing Bolts (located on each leg) **on one side of the machine only.**

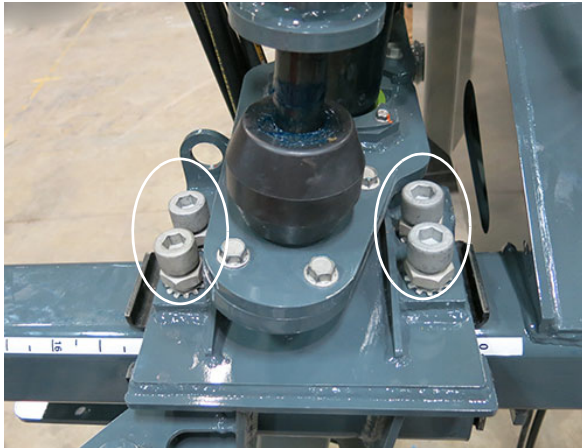

Tread Adjust Bearing Bolts - Top/Side
(Located on each leg)
-Typical View

7. Install a suitable prop item (i.e. steel tube) beneath each front and rear air bag mounting plate (**on the side of machine in which tread is being adjusted**) to prevent the suspension from extending, as shown in the following photo.



Steel Tube Installed Beneath
Air Bag Mounting Plate
-Typical View

8. Deflate Air Bags by releasing air from Air Bag Valves - **on the side of machine which tread is being adjusted**.

*NOTE: Refer to “Air Suspension Exhaust”
provided elsewhere in this section for
further information.*



Air Bag Valve
(Located on top of each air bag)
-Typical View

9. Raise the machine until the tires (**on the side of machine in which tread is being adjusted**) are just off the ground.

NOTE: Refer to “Lifting Your Machine” provided elsewhere in this section for further information.

10. Loosen the lock nut on the end of each front and rear Tread Adjust Turnbuckle Rod (located between the frame and leg - **on the side of machine in which tread is being adjusted**). Rotate the front and rear turnbuckles to move tread in or out as desired.

NOTE: Adjust tread width on both legs in small increments. Binding may occur if larger adjustments are made all at once, especially if adjusting one leg at a time.

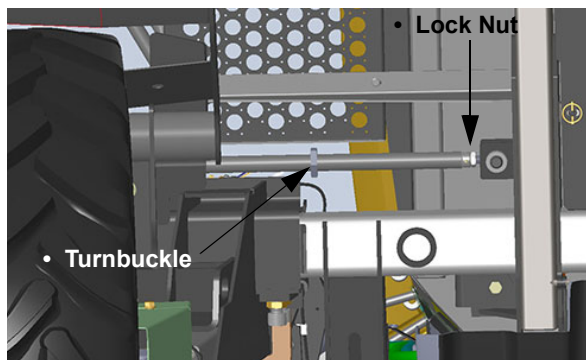

Tread Adjust Turnbuckle Rod
(Located between the frame and leg)
-Typical View

11. Observe the corresponding Tread Adjust Indicator (located on slide path).



Tread Adjust Indicator
(Located on slide path)
-Typical View

12. Re-tighten the front and rear Tread Adjust Bearing Bolts.
13. Re-tighten lock nut on the front and rear Tread Adjust Turnbuckle Rods.
14. Carefully lower machine to ground.
15. Repeat procedure to adjust tread width on opposite side of machine.

NOTE: All four tread adjust indicators should have identical readings after tread adjustment is complete.

TALL CROP PACKAGE - INSTALLATION

NOTE: Ensure correct Belly Shield configuration before installing.

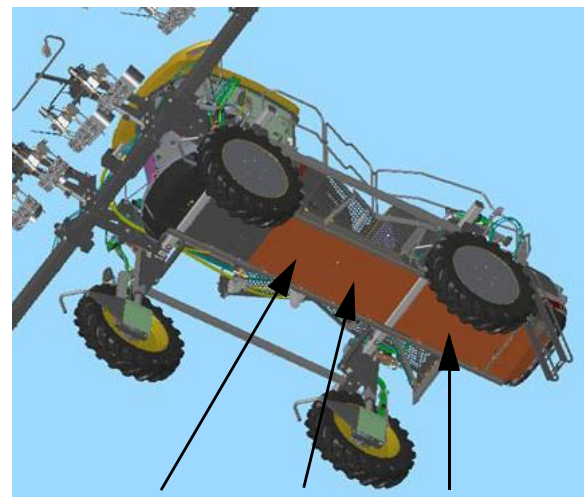

• Panel 1 • Panel 2 • Panel 3

Belly Shield Installation
-Typical View

** View shown from bottom side of machine*

NOTE: Two persons are required when installing the Tall Crop Package.

Installing Belly Shields

1. Install Securement Pin Assembly (Hanger Pin and Securement Pin) onto each Retaining Bracket (located along frame).

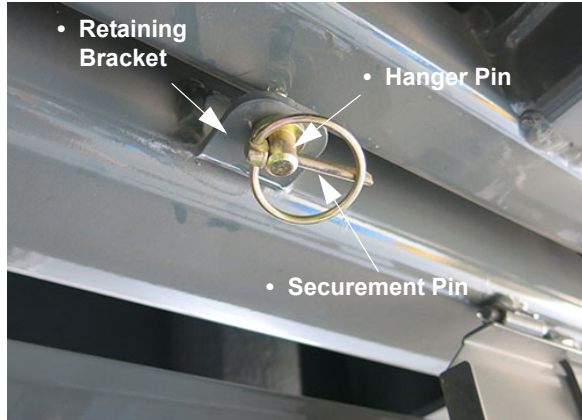

Retaining Bracket/
Securement Pin Assembly
-Typical View

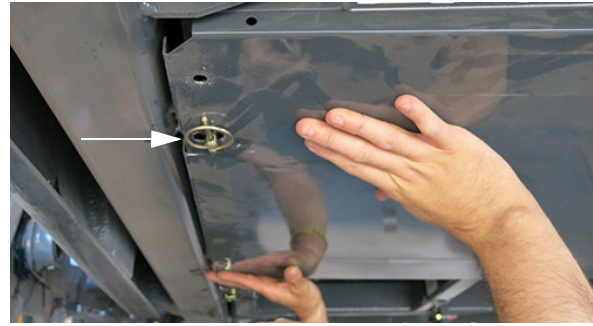

Securement Pin
(Installed into Hanger Pin)
-Typical View

2. Starting with Panel 1, install Support Hook Assemblies into the corresponding Hinge Bushings (located along frame).
3. Install Cotter Pin onto the end of each support hook.

6. Using a 1/2" wrench or socket, tighten the belly shield nuts and bolts, as shown.

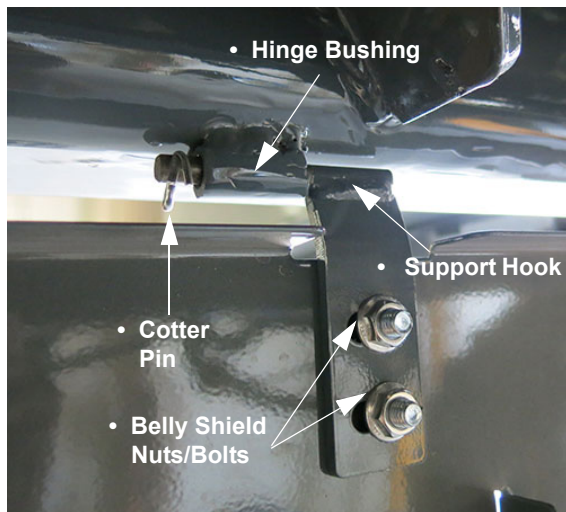

-Typical View



-Typical View

7. Repeat previous steps to install Panels 2 and 3.

NOTE: Ensure belly shield nuts and bolts are loose.

4. On opposite side of machine, remove previously installed Securement Pins (from Hanger Pins).
5. Lift panel and align hole openings with Hanger Pins. Attach by reinstalling the Securement Pins.

Assemble/Install Rear Brush Curtain

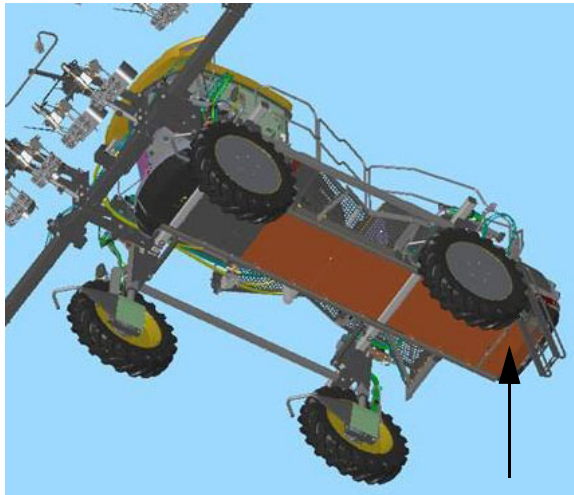

Rear Brush Curtain
-Typical View

* View shown from bottom side of machine

8. Place Curtain Mounting Bracket (bend side up) beneath edge of Brush Curtain, aligning the pre-drilled holes on each.
9. Arrange Curtain Support Strips along the edge of Brush Curtain, aligning the pre-drilled holes.

NOTE: Ensure the notches of each Curtain Support Strip are facing inward (where they will later be adjoined together).

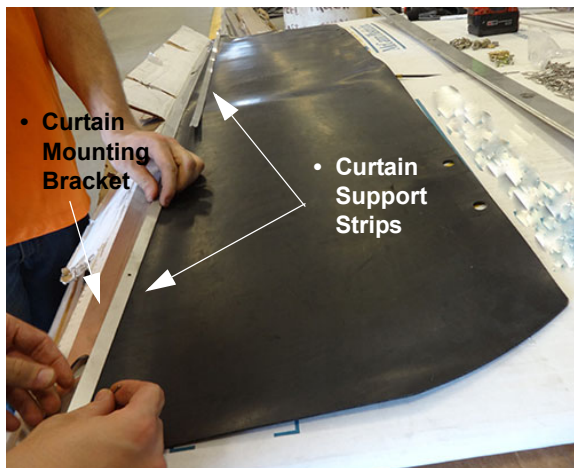

-Typical View

10. Starting at the end of the assembly, insert a 1/8" stainless steel rivet through

the top of Curtain Support Strip, Brush Curtain, and Curtain Mounting Bracket.

NOTE: Ensure Curtain Mounting Bracket bend is facing UP, as shown in the following photo.



Brush Curtain Assembly
-Typical View

11. Use a rivet gun to secure.



-Typical View

12. Repeat process to secure the remainder of the assembly, ensuring that the notches of Curtain Support Strips adjoin together.
13. Install assembled Brush Curtain onto Hanger Pins (located on the rear cross tube).

SECTION 9 – MISCELLANEOUS



14. Install Securement Pins into each of the Hanger Pins.

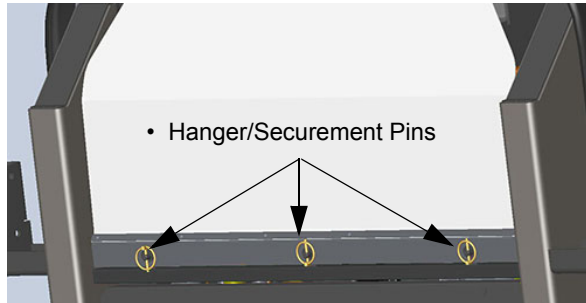

Brush Curtain Mounted to Rear Cross Tube
-Typical View

15. Raise Brush Curtain and position the edge of curtain on top of the Hood Pivot Tube.
16. Align Brush Curtain and Hood Pivot Tube holes and install the four (4) Brush Curtain Mounting Bolts.
17. Install a 5/16-18" nut to the bottom of each bolt and hand-tighten.

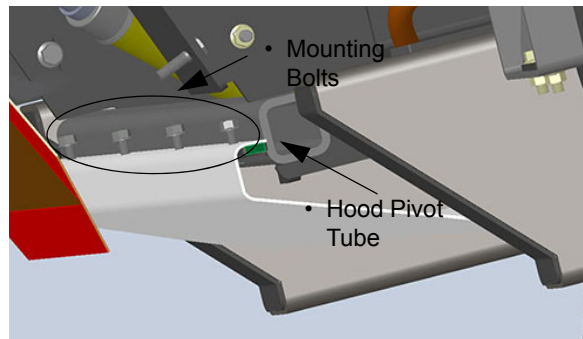

Brush Curtain Mounted to Hood Pivot Tube
-Typical View

18. Using a 1/2" wrench, tighten Brush Curtain Mounting Bolts to 8 ft.-lbs.



Brush Curtain Installation
-Typical View

Installing Crop Dividers

1. Align the holes of the crop divider mounting plate assembly with the holes located on the inside lower leg assembly.
2. Install three (3) 1/2" x 1 3/4" serrated flange bolts into each of the hole openings with the pre-installed 3/4" weld nuts.

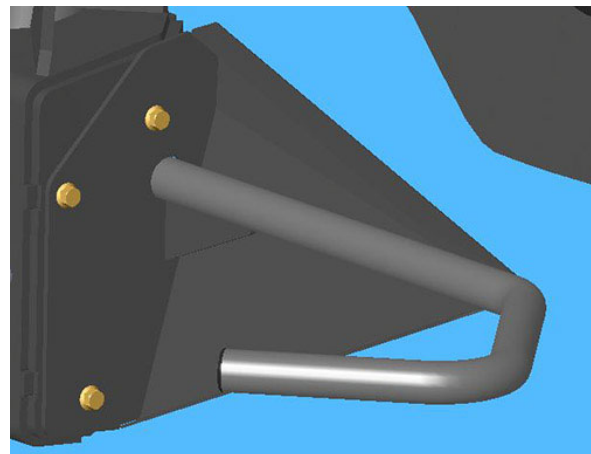

Crop Divider Assembly
-Typical View

3. Tighten using a 3/4" wrench.

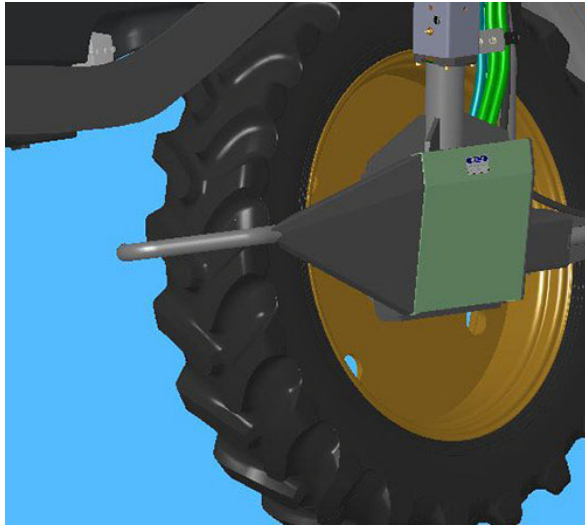

Crop Divider Installation
-Typical View

4. Repeat steps to install remaining Crop Dividers.

Installing Wheel Covers

NOTICE

Remove two (2) lug nuts at a time from the wheel bolts when installing the hub cap adapter plates.

1. Remove two (2) lug nuts from two (2) of the wheel bolts and set aside.
2. Install Hub Cap Adapter Plate onto the two bolts, as shown in the following photo.
3. Reinstall the two lug nuts onto bolts and using a 15/16" socket, re-torque to 185 ft.-lbs.
Refer to "Service - Bolt Torque" provided in the *Maintenance and Storage Section* elsewhere in this manual for further information.

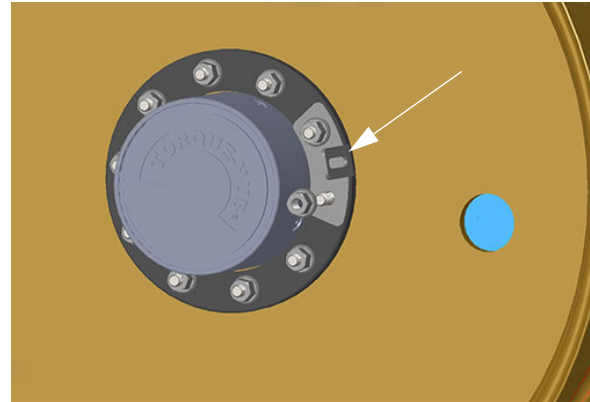

Hub Cap Adapter Plate
-Typical View

4. Perform Steps 1-3 to install remaining adapter plates, ensuring only two (2) lug nuts are removed from the wheel bolts at one time.

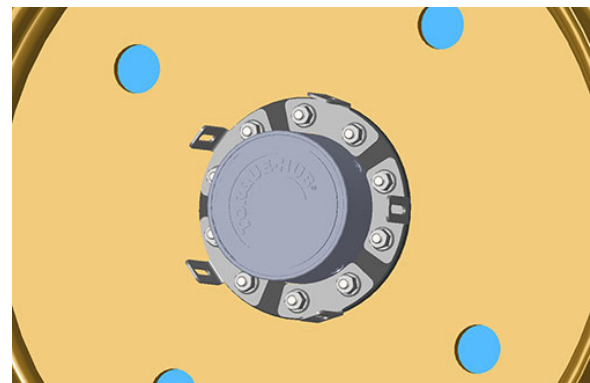

-Typical View

5. Install the Hub Cap Adapter Weldment onto the outside of the previously installed Hub Cap Adapter Plates.

NOTE: Ensure the Hub Cap Adapter Weldment is flush with the face of the wheel hub.



Hub Cap Adapter Weldment
-Typical View



-Typical View

6. Install 1/2" bolt through the hub cap adapter assembly. Install nut to bolt and tighten with a 3/4" wrench.

NOTE: Repeat for each adapter assembly location around the wheel hub.

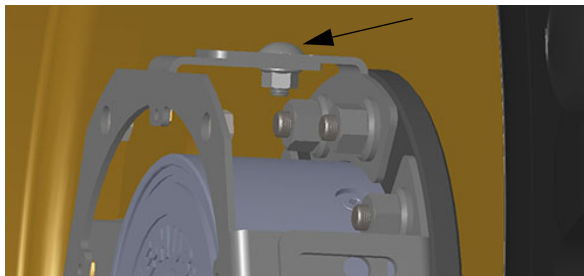

Hub Cap Adapter Bolt Installation
-Typical View

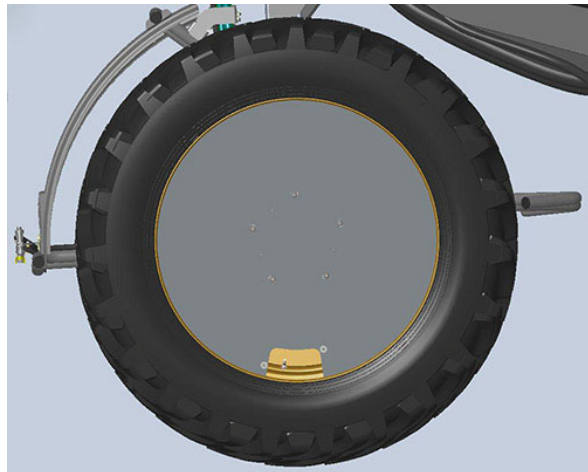

-Typical View

7. Install Wheel Cover onto the hub cap adapter assembly.

NOTE: Ensure the rectangular cut-out on the wheel cover is aligned with the tire valve stem, as shown.

8. Install 1/2" mounting bolt through the front of wheel cover into the Hub Cap Adapter Weldment weld nuts.



Wheel Cover Mounting Bolt Installation
-Typical View

9. Tighten with a 5/16" hex wrench.

NOTE: Repeat for each adapter assembly location around the wheel hub.

10. Install Valve Stem Access Panel to the Wheel Cover.

11. With the hole openings aligned, install a 1/4" bolt (tighten with 5/32" Allen wrench) and nut (tighten with 7/16" wrench) into the upper left holes.

12. Install a 1/4" bolt through the lower right hole in the access panel and tighten with a 5/32" Allen wrench.



Valve Stem Access Panel
-Typical View

13. Install Hub Cap Access Panel to center of wheel cover, ensuring the hole openings of each are properly aligned.

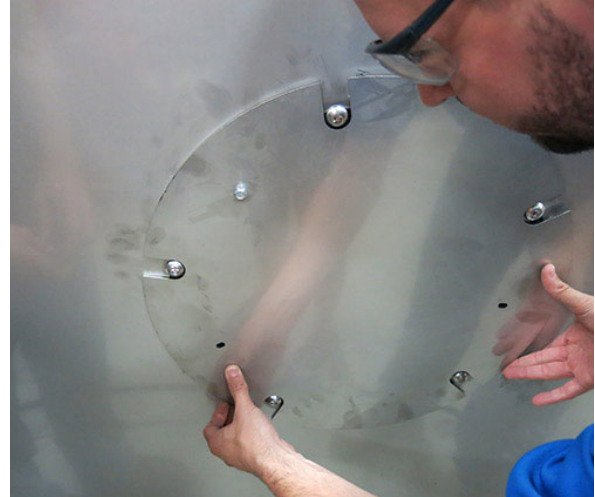

Hub Cap Access Panel
-Typical View

14. Install 1/4" bolt through access panel and wheel cover, tightening with a 5/32" Allen wrench.

15. Wheel cover installation complete.

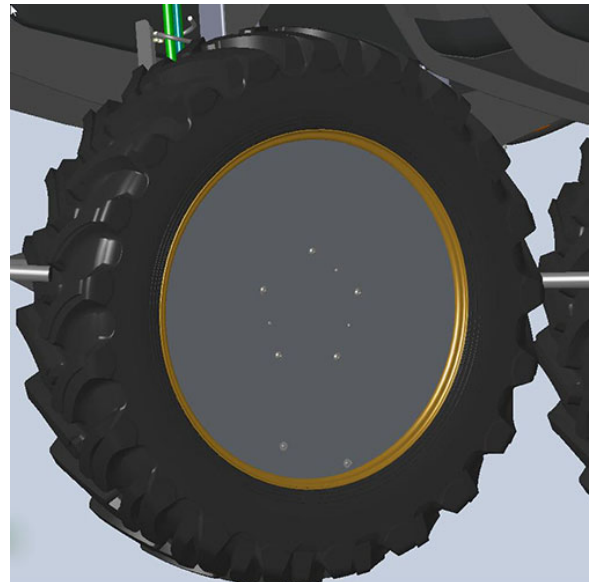

Wheel Cover Installation
-Typical View

TROUBLESHOOTING

Problem	Possible Cause	Suggested Remedy
Engine will not crank	<ul style="list-style-type: none"> • Dead battery • Poor battery connections • Starter or starter relay • Blown fuse in engine electric box • Battery Disconnect Switch in the OFF position • Parking brake not engaged 	<ul style="list-style-type: none"> • Recharge or replace battery • Clean and tighten connections • Test (rebuild or replace) • Check/replace fuse • Turn Battery Disconnect Switch to the ON position • Engage parking brake
Engine will not start	<ul style="list-style-type: none"> • Fuel tank empty • Clogged fuel filter(s) • Cold weather • E-Stop Switch is engaged • Low starter speed • Blown fuse in engine box 	<ul style="list-style-type: none"> • Fill fuel tank • Replace fuel filter(s) • Refer to the engine manufacturer's operation manual for cold weather starting • Disengage E-Stop Switch • Check starter and battery • Check/replace fuse
Engine overheats	<ul style="list-style-type: none"> • Engine overload • Dirty radiator core/grille screen • Faulty radiator cap • Fan malfunction • Faulty thermostat • Low coolant level 	<ul style="list-style-type: none"> • Reduce load • Remove foreign material and clean all items • Replace radiator cap • Check fan speed • Replace thermostat • Refill to proper level
Engine misfires (runs uneven/low power)	<ul style="list-style-type: none"> • Water in fuel • Dirty air cleaner element • Poor grade of fuel • Fuel tank vent clogged • Clogged fuel filter(s) 	<ul style="list-style-type: none"> • Drain, flush, replace filter, fill system • Replace air cleaner element • Drain system, change to a higher fuel grade • Open fuel tank vent (in cap) • Replace fuel filter(s)
Engine knocks	<ul style="list-style-type: none"> • Low oil level in crankcase • Cold engine 	<ul style="list-style-type: none"> • Add oil to full mark • Allow proper warm-up period, refer to engine manufacturer's operation manual
Machine will not move in either direction	<ul style="list-style-type: none"> • Engine speed too low • Oil level in hydraulic reservoir too low • Clogged pressure filter • Hydrostatic System failure 	<ul style="list-style-type: none"> • Set engine at operating RPM • Fill hydraulic reservoir to proper level with approved oil • Replace pressure filter • Contact your local John Deere dealer for assistance
Machine will move in only one direction	<ul style="list-style-type: none"> • Hydrostatic System failure 	<ul style="list-style-type: none"> • Contact your local John Deere dealer for assistance

Hydrostatic system responding slowly	<ul style="list-style-type: none"> • Engine speed too low • Oil in hydraulic reservoir low • Cold oil • Plugged filter • Partially restricted suction line • Hydrostatic System failure 	<ul style="list-style-type: none"> • Set engine at operating RPM • Fill hydraulic reservoir to proper level with approved oil • Allow adequate warm-up period • Check and replace filter • Inspect for collapsed suction hose • Contact your local John Deere dealer for assistance
Noisy hydrostatic system	<ul style="list-style-type: none"> • Cold oil • Low engine speed • Oil level in hydraulic reservoir low • Hydrostatic System failure 	<ul style="list-style-type: none"> • Allow adequate warm-up period • Increase engine speed • Fill hydraulic reservoir to proper level with approved oil • Contact your local John Deere dealer for assistance
Entire hydraulic system fails to function	<ul style="list-style-type: none"> • Oil level in hydraulic reservoir too low • Auxiliary hydraulic system failure 	<ul style="list-style-type: none"> • Fill hydraulic reservoir to proper level with approved oil • Contact your local John Deere dealer for assistance
Noisy hydraulic pump	<ul style="list-style-type: none"> • Oil level in hydraulic reservoir too low • Auxiliary hydraulic system failure 	<ul style="list-style-type: none"> • Fill hydraulic reservoir to proper level with approved oil • Contact your local John Deere dealer for assistance
Noisy hydraulic pump	<ul style="list-style-type: none"> • Oil level in hydraulic reservoir too low • Auxiliary hydraulic system failure 	<ul style="list-style-type: none"> • Fill hydraulic reservoir to proper level with approved oil • Contact your local John Deere dealer for assistance
AWS System will not turn on	<ul style="list-style-type: none"> • AWS Button (located on the Machine Display) is OFF • Machine not in Field Mode • Sensor or valve malfunction 	<ul style="list-style-type: none"> • Turn AWS Button ON • Change machine's drive state to Field Mode • Contact your local John Deere dealer for assistance
AWS System is ON, but rear tires do not follow behind the front tires	<ul style="list-style-type: none"> • Machine speed is greater than AWS shutoff speed • Sensor or valve malfunction 	<ul style="list-style-type: none"> • This is left up to the operator's discretion • Contact your local John Deere dealer for assistance
AWS System inoperable, machine will only move at slow speed	<ul style="list-style-type: none"> • Sensor malfunction 	<ul style="list-style-type: none"> • Move the Hydrostatic Drive Control Handle to NEUTRAL, wait for the "FAULT" drive state to disappear on the Machine Display, and restart machine <p><i>NOTE: In Road mode, the rear tires are locked until the machine is put into Field mode.</i></p>

**SECTION 9 –
MISCELLANEOUS**



Entire electrical system is dead	<ul style="list-style-type: none"> • Dead battery • Poor battery connection • Low charge rate • No charge rate • Battery Disconnect Switch is in the OFF position 	<ul style="list-style-type: none"> • Replace battery • Clean and tighten battery connections • Tighten alternator belt • Replace alternator • Turn Battery Disconnect Switch to the ON position
Light system does not function	<ul style="list-style-type: none"> • Poor ground • Burned out bulb • Separation or short in wire • Blown fuse • Faulty switch • Ignition switch is OFF 	<ul style="list-style-type: none"> • Clean and tighten ground • Replace bulb • Check continuity and replace wire • Replace fuse • Replace switch • Turn ignition switch ON
Lifting mechanism will not lift	<ul style="list-style-type: none"> • Bad cylinder • Blown relief valve • Relief valve set too low • Lift arms seized • Faulty electro-hydraulic valve 	<ul style="list-style-type: none"> • Check cylinder - remove and rebuild or replace • Remove, inspect, replace • Contact your local John Deere dealer for assistance • Loosen mounting bolts, lubricate grease fittings (if equipped) • Contact your local John Deere dealer for assistance
Cutter head blades, quad pullers, rollers, or ties will not turn	<ul style="list-style-type: none"> • Oil level in reservoir too low • Oil not reaching pump • Faulty hydraulic pump • Faulty hydraulic motor(s) 	<ul style="list-style-type: none"> • Fill reservoir to proper level with approved oil • Remove suction hose from pump and check for proper flow, reinstall hose and all suction fittings • Replace hydraulic pump • Replace motor(s)
Hydraulic motor leaking	<ul style="list-style-type: none"> • Seal failure • Restricted case drain hose 	<ul style="list-style-type: none"> • Replace seal, turn heads on with low engine RPM • Inspect or replace hose
No units will lift	<ul style="list-style-type: none"> • Oil in hydraulic reservoir low • Faulty valve • Relief valve in electro-hydraulic valve set too low 	<ul style="list-style-type: none"> • Fill reservoir to proper level • Repair or replace valve • Contact your local John Deere dealer for assistance
No units will lower	<ul style="list-style-type: none"> • Lift arm pivots too tight 	<ul style="list-style-type: none"> • Lubricate and loosen pivot points
Only one unit will not lower	<ul style="list-style-type: none"> • Faulty valve • Lift arm pivot too tight 	<ul style="list-style-type: none"> • Replace valve • Lubricate and loosen pivot point

All units lift slowly	<ul style="list-style-type: none"> Hydraulic oil not at operating temperature Faulty valve Lift arm pivots too tight Relief valve in electro-hydraulic valve system set too low 	<ul style="list-style-type: none"> Allow time for oil to warm up Replace valve Lubricate and loosen pivot points Contact your local John Deere dealer for assistance
Only one unit lifts slowly	<ul style="list-style-type: none"> Faulty valve Lift arm pivot points too tight 	<ul style="list-style-type: none"> Replace valve Lubricate/loosen pivot points
Only one unit will not hold position	<ul style="list-style-type: none"> Oil leak between valve and cylinder Faulty valve Faulty lower poppet on lift valve 	<ul style="list-style-type: none"> Repair leak or replace hose Replace valve Remove, clean/replace
No units will hold position	<ul style="list-style-type: none"> Non-hydraulic issue 	<ul style="list-style-type: none"> Refer to the Tasselrol information elsewhere in this manual
Only one unit lowers slowly	<ul style="list-style-type: none"> Faulty valve Faulty lower poppet on lift valve 	<ul style="list-style-type: none"> Replace valve Remove, clean/replace
All units lower slowly	<ul style="list-style-type: none"> Hydraulic oil not at operating temperature 	<ul style="list-style-type: none"> Allow time for oil to warm up
In MANUAL mode, more than one unit lifts or lowers using one up/down switch	<ul style="list-style-type: none"> Faulty valve 	<ul style="list-style-type: none"> Replace valve

SECTION 9 – MISCELLANEOUS



In AUTO mode, more than one unit raises from photo sensor	<ul style="list-style-type: none"> Faulty valve 	<ul style="list-style-type: none"> Replace valve
In AUTO mode, wrong unit raises from photo sensor	<ul style="list-style-type: none"> Cylinder hoses are connected to the wrong cylinder Electronic malfunction 	<ul style="list-style-type: none"> Attach correct hoses to proper cylinder Contact your local John Deere dealer for assistance
No units will lift	<ul style="list-style-type: none"> Blown Fuse Faulty #1 valve, coil, or loose coil mounting nut Loose wire connections Faulty wire connections Faulty main wire assembly 	<ul style="list-style-type: none"> Find short in wire, repair, and replace fuse Tighten or replace coil Find loose connection, tighten Replace or repair Replace or repair
Only one unit will not lift	<ul style="list-style-type: none"> Light photo sensor assembly Faulty valve, coil, or loose coil mounting nut Loose wire connections Photo sensor lights not lined up with reflector Faulty row wire assembly Faulty sensor connector wire 	<ul style="list-style-type: none"> Replace photo sensor Tighten nut or replace coil Find loose connections, tighten Line up sensor with reflector Replace or repair Replace or repair
No units will lower	<ul style="list-style-type: none"> Blown fuse In AUTO mode, LS valve assembly unplugged Loose wire connection 	<ul style="list-style-type: none"> Find short in wire, repair, and replace fuse Plug in wire assembly Find loose connection, tighten
Only one unit will not lower	<ul style="list-style-type: none"> Light photo sensor inoperable Faulty valve, coil, or loose coil mounting nut Loose wire connection Lights of photo sensor not lined up with reflector Faulty row wire assembly Faulty sensor connector wire assembly 	<ul style="list-style-type: none"> Replace photo sensor Tighten nut or replace coil Find loose connection, tighten Line up sensor with reflector Replace or repair Replace or repair
No units will hold position	<ul style="list-style-type: none"> In AUTO mode, no crop moving under assemblies 	<ul style="list-style-type: none"> Drive forward or select MANUAL mode
In AUTO mode, wrong unit raises from sensor assembly	<ul style="list-style-type: none"> Row LS wire assembly plugged into wrong sensor connector 	<ul style="list-style-type: none"> Plug correct wire assembly into proper row sensor connector assembly



A Word From Hagie Manufacturing	
Company	1-1
About This Manual	1-1
Air Suspension Exhaust	9-8
All-Wheel Steer (AWS)	4-15
Attachment Assembly	7-14
Batteries	6-1
Battery Disconnect Switch	6-2
Detasseling System - Operation	7-9
Detasseling System Components	7-1
Electric Hood	9-10
Emergency Exit	2-8
Emergency Stop	2-7
Engine - Starting	4-1
Engine Aftertreatment - Final Tier 4	4-3
Fire Extinguisher	2-9
Fold Procedure - Detasseler Tool Bar	7-6
Front End Access	9-11
Fuse and Relay Ratings	6-8
Fuses and Relays	6-4
Hydraulic System Components	5-1
Hydrostatic Drive	4-10
Identification	1-3
Intended Use	2-1
Ladder	5-9
Lifting Your Machine	9-6
Machine Display	3-24
Operator Presence Switch (OPS)	2-6
Operator's Station	3-7
Product Warranty	1-3
Reversible Fan - Variable Pitch	5-4
Rotating Beacon	2-7
Safety Decals	2-9
Safety Messages Used In This	
Manual	1-2
Safety Precautions	2-1
Seat - Instructor	3-7
Seat - Operator (Premium)	3-4
Seat - Operator (Standard)	3-1
Seat Belt	2-7
Service - Air Springs	8-30
Service - Bolt Torque	8-25
Service - Engine Drive Belt	8-24
Service - Filters	8-11
Service - Fluids	8-1
Service - Lubrication	8-21
Service - Miscellaneous	8-31
Service - Toe-In	8-28
Service and Assistance	1-2
Service Intervals	8-33
Sound Level	1-4
Specifications	1-6
Storage	8-36
Tall Crop Package - Installation	9-15
Tasselrol™ XL/LS System 12	7-11
Torque Values	1-15
Towing	9-4
Transporting	9-1
Tread Adjustment - Hydraulic	5-6
Tread Adjustment - Manual	9-12
Troubleshooting	9-22
Viscous Clutch Fan	9-8
Whole Body Vibration	1-4

NOTES

NOTES

NOTES
